



**THE DATASHEET OF  
SM0805UYC**



# SURFACE MOUNT LED YELLOW, 0805 PACKAGE

# BIVAR

## SM0805UYC

- ◆ Industry Standard 0805 Package
- ◆ RoHS Compliant
- ◆ Small Package and Footprint
- ◆ Water Clear Lens
- ◆ Wide Viewing Angle
- ◆ Ideal for Status Indication, Display, and Backlighting

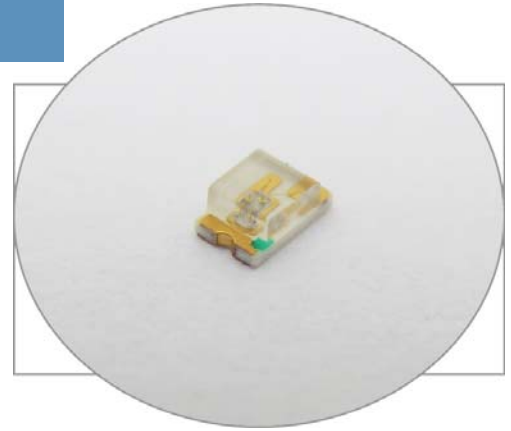

Bivar Surface Mount 0805 package LED may be used in nearly any lighting or indication application. The miniature package is ideal for small scale applications such as general indication and backlighting. Low power consumption and excellent long life reliability are suitable for battery powered equipment. Bivar offers water clear LED lens for maximum luminous intensity. Wide variety of wavelength and intensity combinations are available to meet any illumination need. The SM0805 LED is packaged in standard tape and reels for pick and place assemblies.

Part Number	Material	Emitted Color	Peak Wavelength $\lambda_p$ (nm) TYP.	Lens Appearance	Luminous Intensity (mcd) TYP.	Viewing Angle
SM0805UYC	AlGaInP	YELLOW	593	Water Clear	70	130°

## Outline Dimensions

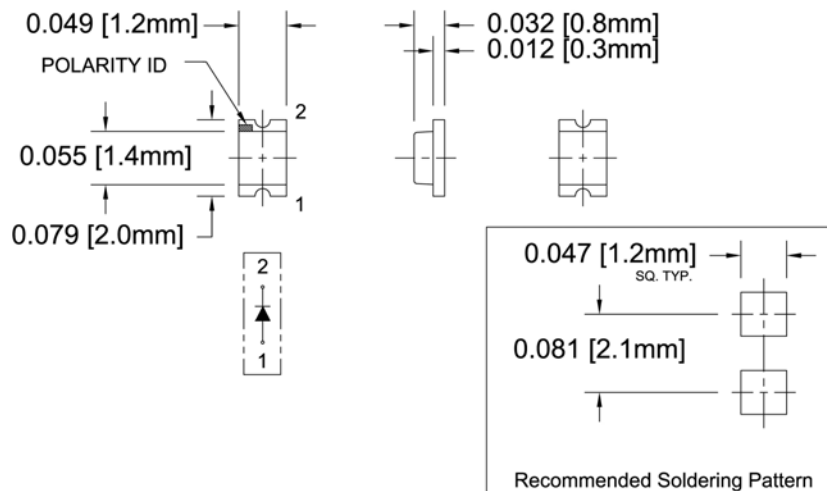

### Outline Drawings Notes:

1. All dimensions are in inches [millimeters].
2. Standard tolerance:  $\pm 0.010$ " unless otherwise noted.



Bivar reserves the right to make changes at any time without notice.

# SURFACE MOUNT LED YELLOW, 0805 PACKAGE



## Absolute Maximum Ratings

$T_A = 25^\circ\text{C}$  unless otherwise noted

Power Dissipation	78 mW
Forward Current ( DC )	30 mA
Peak Forward Current <sup>1</sup>	100 mA
Reverse Voltage	5 V
Operating Temperature Range	-30 ~ +80°C
Storage Temperature Range	-40 ~ +85°C
Lead Soldering Temperature ( 3 mm from the base of the epoxy bulb ) <sup>2</sup>	260°C

Notes: 1. 10% Duty Cycle, Pulse Width  $\leq$  0.1 msec.      2. Solder time less than 5 seconds at temperature extreme.

## Electrical / Optical Characteristics

$T_A = 25^\circ\text{C}$  &  $I_F = 20\text{ mA}$  unless otherwise noted

Part Number	Forward Voltage (V) <sup>1</sup>			Recommend Forward Current (mA)			Reverse Current ( $\mu\text{A}$ )	Dominant Wavelength (nm) <sup>2</sup>			Luminous Intensity $I_v$ (mcd)			Viewing Angle $2\theta_{1/2}$ (deg)
	MIN	TYP	MAX	MIN	TYP	MAX	MAX	MIN	TYP	MAX	MIN	TYP	MAX	TYP
SM0805UYC	/	2.1	2.6	/	20	/	10	/	592	/	28.5	70	/	130

Notes: 1. Tolerance of forward voltage :  $\pm 0.05\text{V}$ .      2. Tolerance of dominant wavelength :  $\pm 1.0\text{nm}$ .

Bivar reserves the right to make changes at any time without notice.

# SURFACE MOUNT LED YELLOW, 0805 PACKAGE



## Typical Electrical / Optical Characteristics

$T_A = 25^\circ\text{C}$  unless otherwise noted

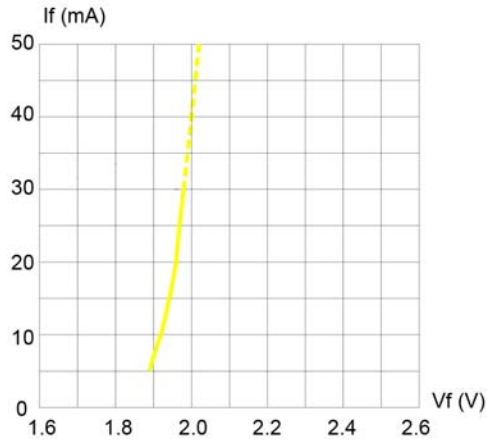

Fig. 1 Forward Current vs. Forward Voltage

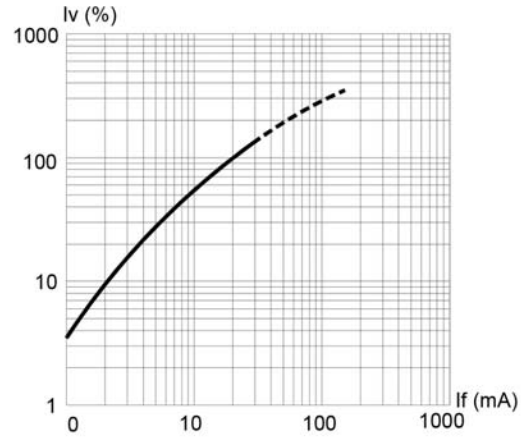

Fig. 2 Relative Luminous Intensity vs. Forward Current

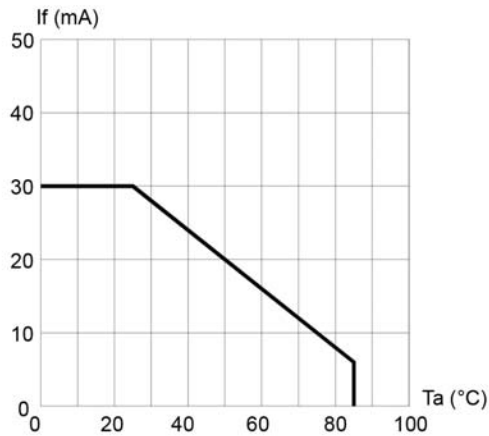

Fig. 3 Forward Current vs. Temperature

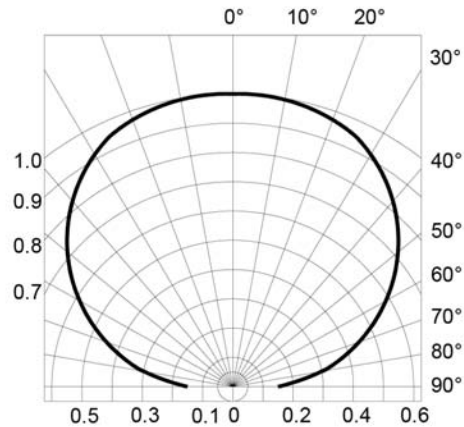

Fig. 4 Directivity Radiation Diagram

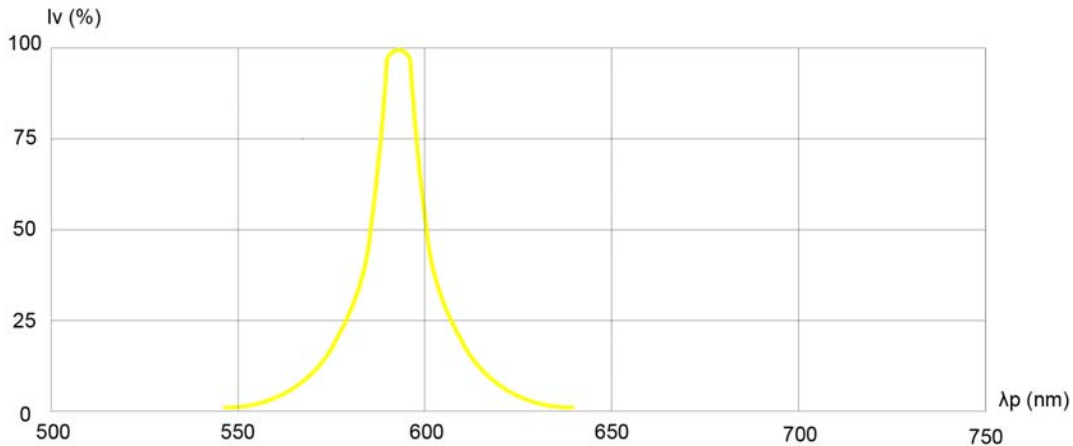

Fig. 5 Relative Luminous Intensity vs. Peak Wavelength

Bivar reserves the right to make changes at any time without notice.

# SURFACE MOUNT LED YELLOW, 0805 PACKAGE



## Recommended Soldering Conditions

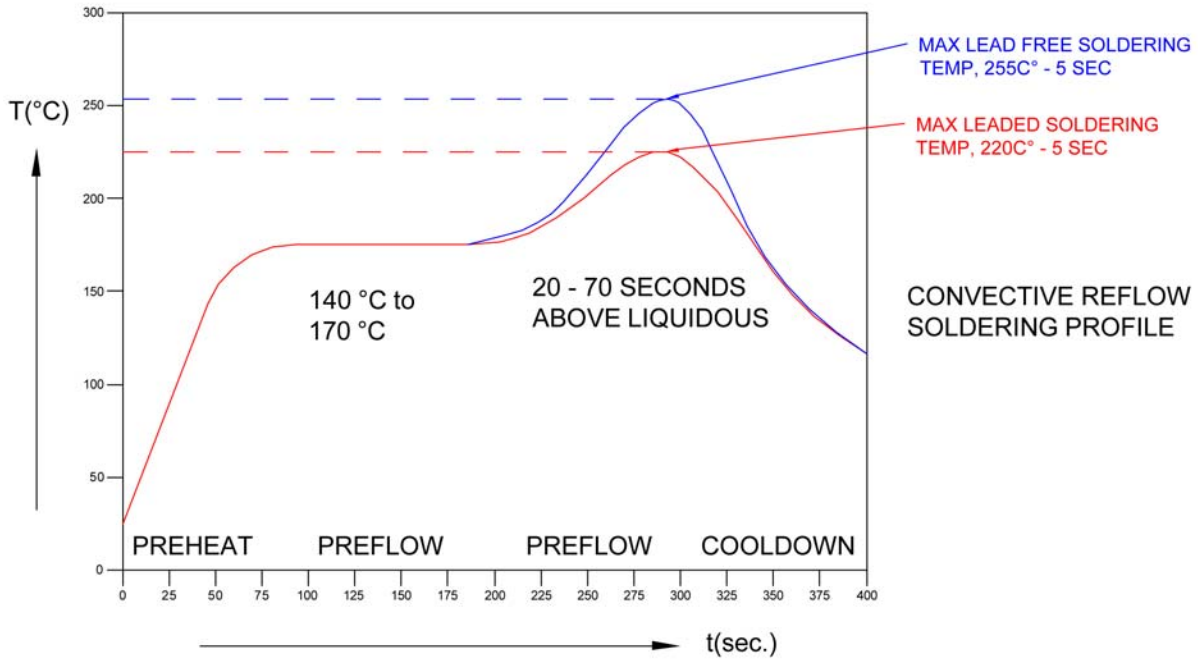

## Tape and Reel Dimensions

Note: 4000 pcs/Reel

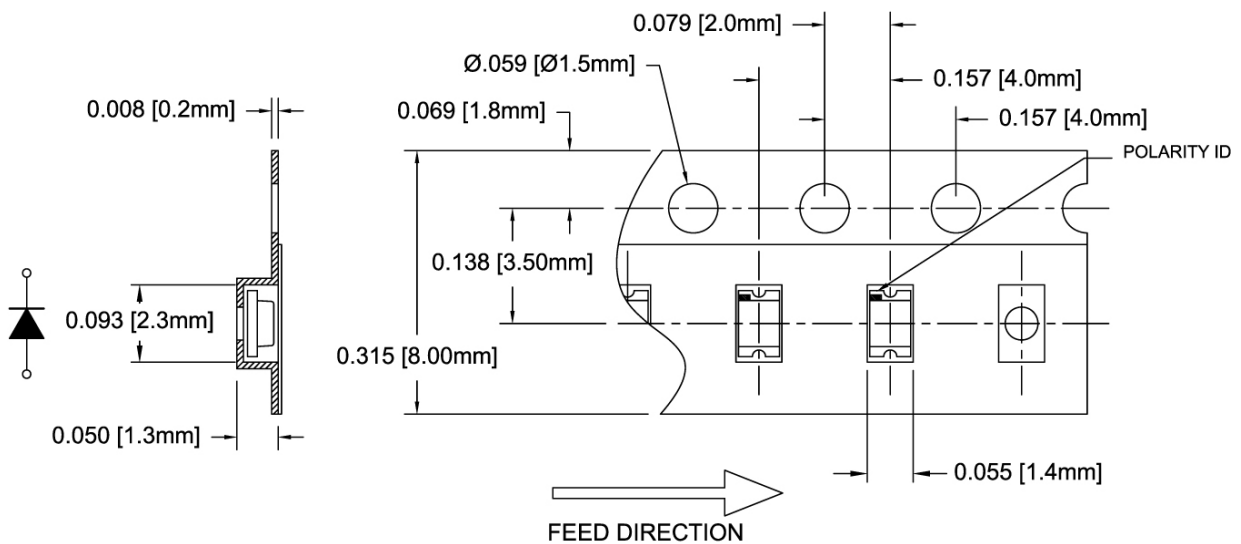

### Outline Drawings Notes:

1. All dimensions are in inches [millimeters].
2. Standard tolerance:  $\pm 0.010''$  unless otherwise noted.

Bivar reserves the right to make changes at any time without notice.

# SURFACE MOUNT LED YELLOW, 0805 PACKAGE



**Outline Drawings Notes:**

1. All dimensions are in inches [millimeters].
2. Standard tolerance unless otherwise noted: X.XXX ± 0.010"  
X.X ± 0.1"

## Packaging and Labeling Plan

**Note: 1 Reel / Bag**

Vacuum and Heat Sealed  
Clear AntiStatic Poly Bag

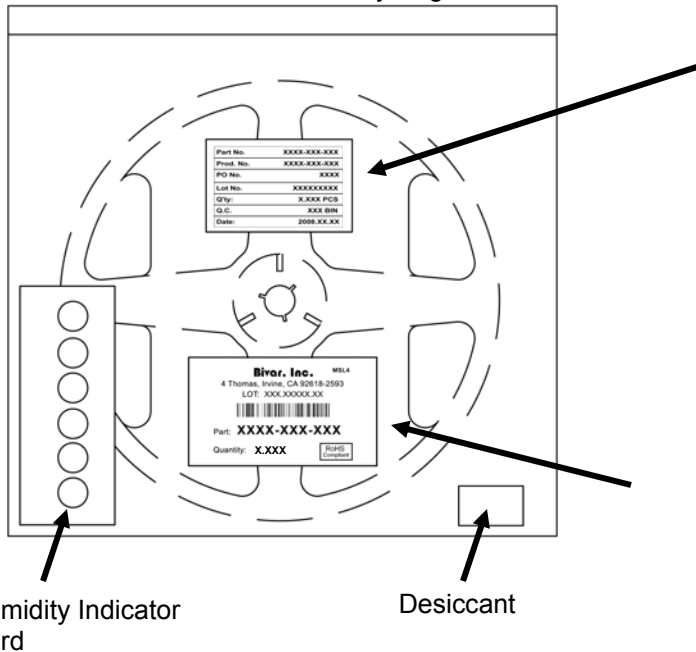

Part No.	XXXX-XXX-XXX
Prod. No.	XXXX-XXX-XXX
PO No.	XXXX
Lot No.	XXXXXXXXXX
Q'ty:	X.XXX PCS
Q.C.	XXX BIN
Date:	2008.XX.XX

Internal Quality Control

**Bivar, Inc.** MSL4

4 Thomas, Irvine, CA 92618-2593  
LOT: XXX.XXXXX.XX



Part: **XXXX-XXX-XXX**

Quantity: **X.XXX**

RoHS  
Compliant

Bivar Standard Packaging Label

Bivar reserves the right to make changes at any time without notice.

## Looking for pricing, stock, or lifecycle information?

Click below to explore more details on WIN SOURCE:

 [View SM0805UYC on WIN SOURCE](#)

 [Bivar Inc. Information](#)

## Optimize Your Supply Chain with WIN SOURCE Solutions

-  Global Sourcing Solution
-  Obsolete Management
-  Cost Control Management
-  Shortage Management
-  Alternative Solution
-  Excess Inventory Management