



THE DATASHEET OF SM0805PGC



SURFACE MOUNT LED PURE GREEN, 0805 PACKAGE

BIVAR

SM0805PGC

- ◆ Industry Standard 0805 Package
- ◆ RoHS Compliant
- ◆ Small Package and Footprint
- ◆ Water Clear Lens
- ◆ Wide Viewing Angle
- ◆ Ideal for Status Indication, Display, and Backlighting

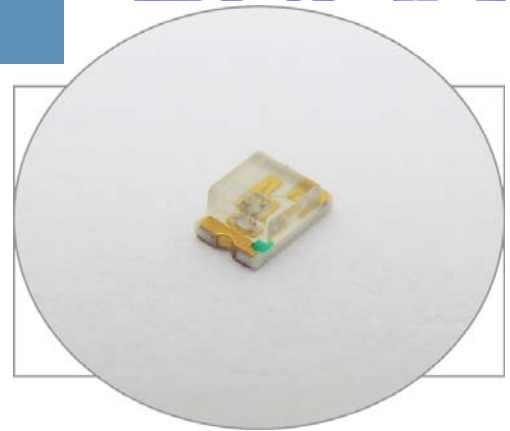

Bivar Surface Mount 0805 package LED may be used in nearly any lighting or indication application. The miniature package is ideal for small scale applications such as general indication and backlighting. Low power consumption and excellent long life reliability are suitable for battery powered equipment. Bivar offers water clear LED lens for maximum luminous intensity. Wide variety of wavelength and intensity combinations are available to meet any illumination need. The SM0805 LED is packaged in standard tape and reels for pick and place assemblies.

Part Number	Material	Emitted Color	Peak Wavelength λ_p (nm) TYP.	Lens Appearance	Luminous Intensity (mcd) TYP.	Viewing Angle
SM0805PGC	GaP	GREEN	555	Water Clear	4.5	130°

Outline Dimensions

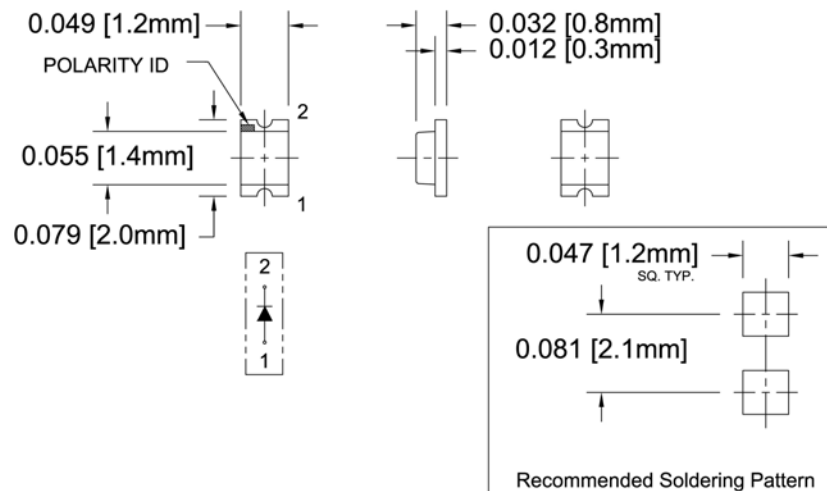

Outline Drawings Notes:

1. All dimensions are in inches [millimeters].
2. Standard tolerance: ± 0.010 " unless otherwise noted.



Bivar reserves the right to make changes at any time without notice.

SURFACE MOUNT LED PURE GREEN, 0805 PACKAGE



Absolute Maximum Ratings

$T_A = 25^\circ\text{C}$ unless otherwise noted

Power Dissipation	78 mW
Forward Current (DC)	30 mA
Peak Forward Current ¹	100 mA
Reverse Voltage	5 V
Operating Temperature Range	-30 ~ +80°C
Storage Temperature Range	-40 ~ +85°C
Lead Soldering Temperature (3 mm from the base of the epoxy bulb) ²	260°C

Notes: 1. 10% Duty Cycle, Pulse Width \leq 0.1 msec. 2. Solder time less than 5 seconds at temperature extreme.

Electrical / Optical Characteristics

$T_A = 25^\circ\text{C}$ & $I_F = 20$ mA unless otherwise noted

Part Number	Forward Voltage (V) ¹			Recommend Forward Current (mA)			Reverse Current (μA)	Dominant Wavelength (nm) ²			Luminous Intensity I_v (mcd)			Viewing Angle $2\theta_{1/2}$ (deg)
	MIN	TYP	MAX	MIN	TYP	MAX	MAX	MIN	TYP	MAX	MIN	TYP	MAX	TYP
SM0805PGC	/	2.0	2.6	/	20	/	10	/	555	/	1	4.5	/	130

Notes: 1. Tolerance of forward voltage : $\pm 0.05\text{V}$. 2. Tolerance of dominant wavelength : $\pm 1.0\text{nm}$.

Bivar reserves the right to make changes at any time without notice.

SURFACE MOUNT LED PURE GREEN, 0805 PACKAGE



Typical Electrical / Optical Characteristics

$T_A = 25^\circ\text{C}$ unless otherwise noted

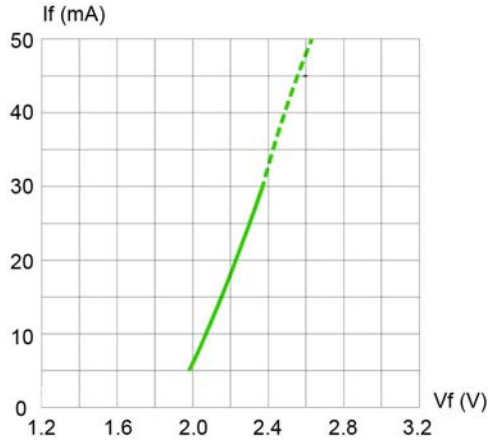

Fig. 1 Forward Current vs. Forward Voltage

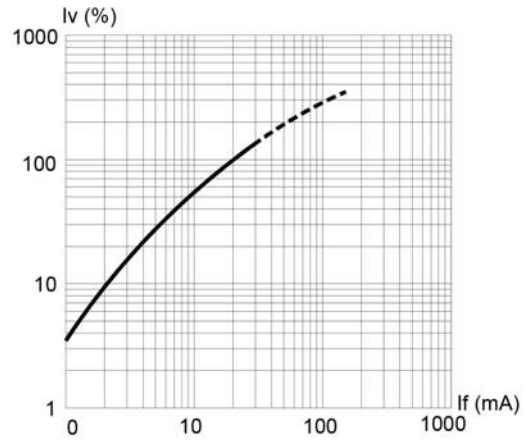

Fig. 2 Relative Luminous Intensity vs. Forward Current

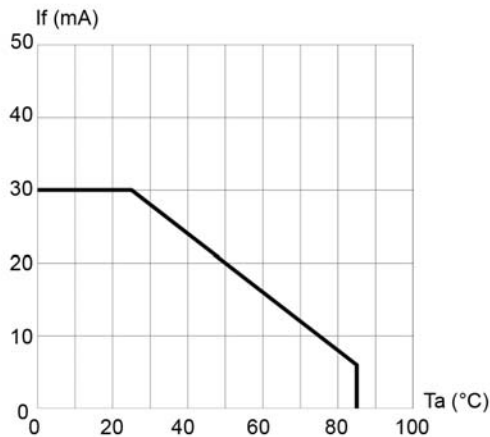

Fig. 3 Forward Current vs. Temperature

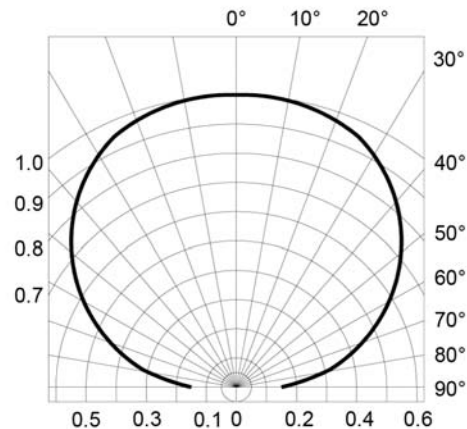

Fig. 4 Directivity Radiation Diagram

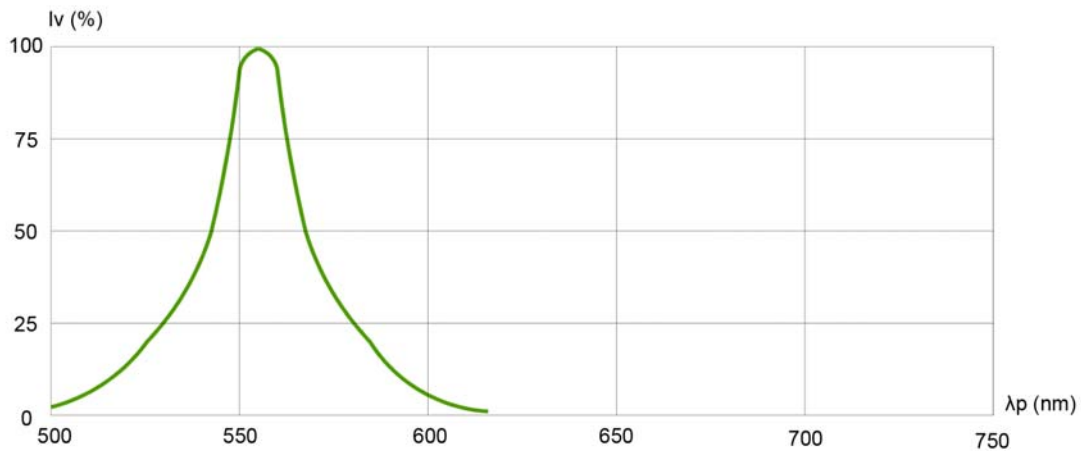

Fig. 5 Relative Luminous Intensity vs. Peak Wavelength

Bivar reserves the right to make changes at any time without notice.

SURFACE MOUNT LED PURE GREEN, 0805 PACKAGE



Recommended Soldering Conditions

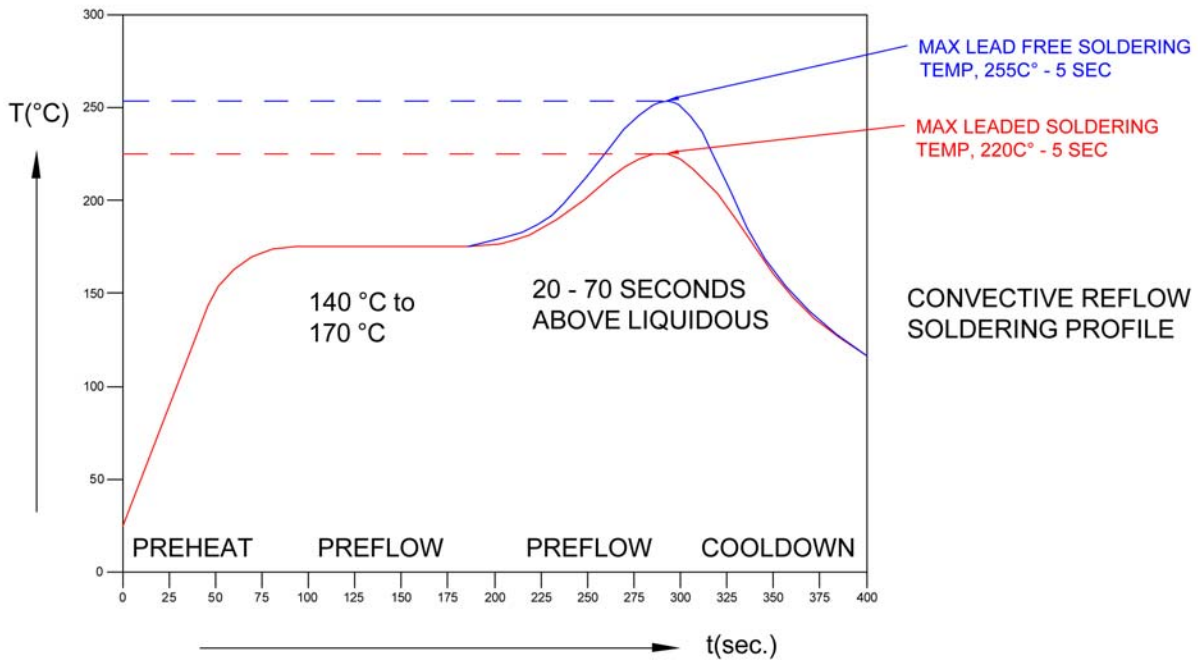

Tape and Reel Dimensions

Note: 4000 pcs/Reel

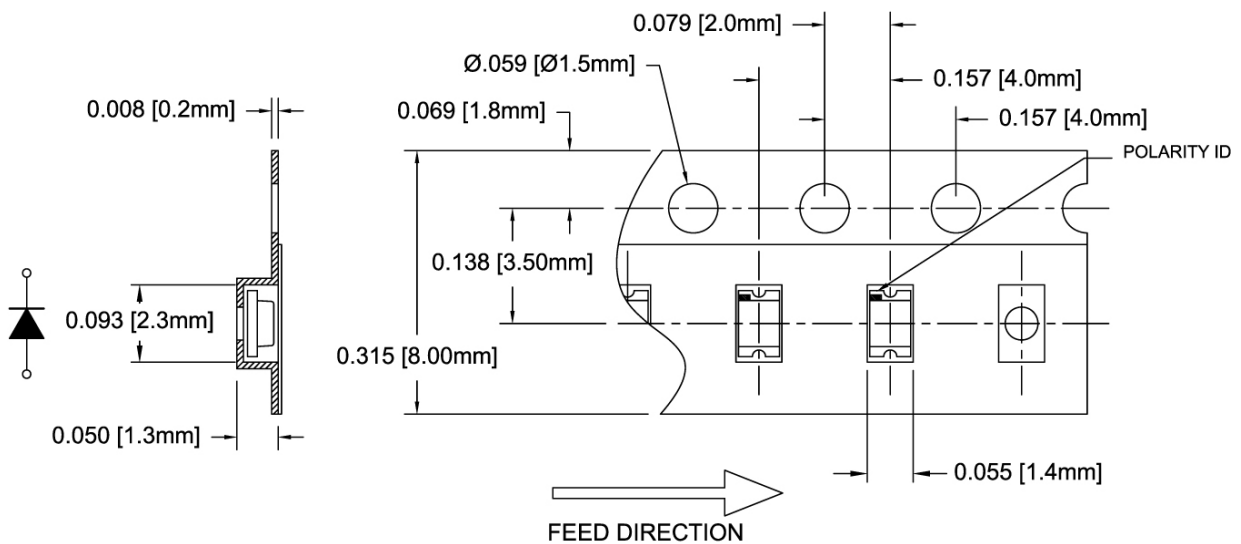

Outline Drawings Notes:

1. All dimensions are in inches [millimeters].
2. Standard tolerance: $\pm 0.010''$ unless otherwise noted.

Bivar reserves the right to make changes at any time without notice.

SURFACE MOUNT LED PURE GREEN, 0805 PACKAGE



Outline Drawings Notes:

1. All dimensions are in inches [millimeters].
2. Standard tolerance unless otherwise noted: X.XXX ± 0.010"
X.X ± 0.1"

Packaging and Labeling Plan

Note: 1 Reel / Bag

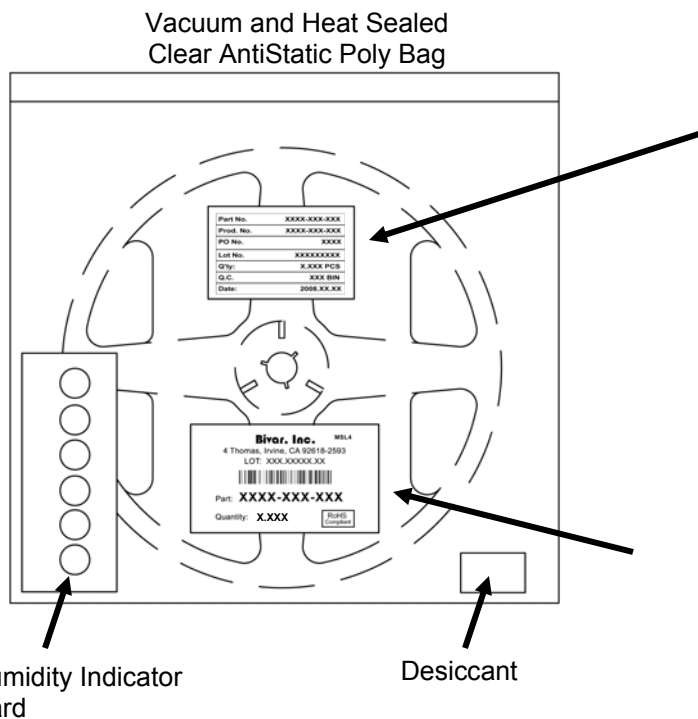

Part No.	XXXX-XXX-XXX
Prod. No.	XXXX-XXX-XXX
PO No.	XXXX
Lot No.	XXXXXXXXXX
Q'ty:	X.XXX PCS
Q.C.	XXX BIN
Date:	2008.XX.XX

Internal Quality Control

Bivar, Inc. MSL4

4 Thomas, Irvine, CA 92618-2593
LOT: XXX.XXXXXX.XX



Part: **XXXX-XXX-XXX**

Quantity: **X.XXX**

RoHS
Compliant

Bivar Standard Packaging Label

Bivar reserves the right to make changes at any time without notice.

Looking for pricing, stock, or lifecycle information?

Click below to explore more details on WIN SOURCE:

 [View SM0805PGC on WIN SOURCE](#)

 [Bivar Inc. Information](#)

Optimize Your Supply Chain with WIN SOURCE Solutions

-  Global Sourcing Solution
-  Obsolete Management
-  Cost Control Management
-  Shortage Management
-  Alternative Solution
-  Excess Inventory Management