



**THE DATASHEET OF
SI-N8W1113B1US**



AC Operating Module

ACOM DLE 120V Reduced Flicker



Samsung AC Operating Module is reasonable solution with better uniformity and high reliability

Features & Benefits

- No dark area and smooth light output
- Easy installation by integrated module
- Simple design for Down-light

Applications

Indoor Lighting:

- Downlight
- Wall Light

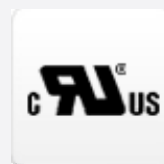

Table of Contents

1.	Product Code Information	-----	3
2.	Characteristics	-----	4
3.	Structure	-----	7
4.	Certification and Declaration	-----	9
5.	Label Structure	-----	10
6.	Packing Structure	-----	12
7.	Precautions in Handling & Use	-----	13
Appendix	Applicable wire	-----	14

1. Sample Code Information

ACOM

Nominal CCT (K)	Product Code
2700	SI-N8W1113B1US
3000	SI-N8V1113B1US
3500	SI-N8U1113B1US
4000	SI-N8T1113B1US
5000	SI-N8R1113B1US

2. Characteristics

ACOM

Item	Rating	Unit	Remark
Rated Lifetime	50,000	hour	L80B10 @ $t_p, 50 = 75$ °C
Ingress Protection (IP)	no rating	-	
Operating Temperature	-20 ~ +50	°C	
Storage Temperature	-30 ~ +80	°C	
Inrush Current	Max. 1.5	A	10us
Light Emitting Surface(LES)	22.5	mm	
Beam Angle	115	°	±5

ACOM

Item	Nom. CCT (K)	Rating			Unit	Remark
		Min.	Typ.	Max.		
Luminous Flux (Φ_v)	2700	1040	1140	1240	lm	$V_{in} = 120 \text{ Vac}$ $t_p = 25 \text{ }^\circ\text{C}$
	3000	1060	1160	1260		
	3500	1090	1190	1290		
	4000	1100	1210	1310		
	5000	1090	1250	1420		
Luminous Efficacy	2700	-	100	-	lm/W	$V_{in} = 120 \text{ Vac}$ $t_p = 25 \text{ }^\circ\text{C}$
	3000	-	102	-		
	3500	-	105	-		
	4000	-	107	-		
	5000	-	110	-		
Luminous Flux (Φ_v)	2700	970	1070	1160	lm	$V_{in} = 120 \text{ Vac}$ $t_p = 65 \text{ }^\circ\text{C}$
	3000	990	1080	1180		
	3500	1010	1110	1210		
	4000	1030	1130	1220		
	5000	1020	1170	1320		
Luminous Efficacy	2700	-	94	-	lm/W	$V_{in} = 120 \text{ Vac}$ $t_p = 65 \text{ }^\circ\text{C}$
	3000	-	95	-		
	3500	-	98	-		
	4000	-	100	-		
	5000	-	103	-		
CCT	2700	-	2700	-	K	$V_{in} = 120 \text{ Vac}$ $t_p = 25 \text{ }^\circ\text{C}$
	3000	-	3000	-		
	3500	-	3500	-		
	4000	-	4000	-		
	5000	-	5000	-		
Color Rendering Index (Ra)		80	-	-	-	
Operating Voltage (V_{in})		108	120	132	Vac	
Power Consumption		10.2	11.4	12.6	W	$V_{in} = 120 \text{ Vac}$
Frequency		-	60	-	Hz	$t_p = 25/65 \text{ }^\circ\text{C}$
Power Factor		0.9	-	-	-	
Percent Flicker		-	50	-	%	Flicker Index 0.18
THD		-	19	20	%	
Hi-pot Test		1.24	-	-	kV	AC input to Bottom

Notes:

- 1) t_p : temperature at which performance is specified, measured at “**Tc point**” and at the rated AC voltage
- 2) Samsung maintains measurement tolerance of: luminous flux = $\pm 7\%$, CRI = ± 1

ACOM

Item	Nominal*	Life**	Max.***	Unit
Temperature	65 (t_p)	75 ($t_{p,50}$) L80B10	100 (t_c)	°C

Notes:

- * Temperature used to specify performance of the module (t_p)
- ** Rated maximum performance temperature at which lifetime is specified ($t_{p,50}$)
- *** Rated maximum temperature, highest permissible temperature to avoid safety risk (t_c)

All temperatures are measured at the designated “**Tc point**” as indicated under Thermal Management drawing, Structure and Assembly section of this Data Sheet

Color Coordinates ($V_{in} = 120 \text{ Vac}$, $t_p = 25 \text{ °C}$)

Model	Nom. CCT (K)	CIE 1931 Chromaticity Coordinates				
		CIE x	CIE y	Center CIE x	Center CIE y	
ACOM	2700	CIE x	0.4478	0.4610	0.4708	0.4571
		CIE y	0.4000	0.4031	0.4571	0.4174
		Center	CIE x	0.4592	CIE y	0.4102
	3000	CIE x	0.4244	0.4381	0.4466	0.4324
		CIE y	0.3925	0.3973	0.4148	0.4098
		Center	CIE x	0.4354	CIE y	0.4036
	3500	CIE x	0.3985	0.4133	0.4203	0.4047
		CIE y	0.3804	0.3875	0.4048	0.3972
		Center	CIE x	0.4092	CIE y	0.3925
	4000	CIE x	0.3744	0.3880	0.3928	0.3785
		CIE y	0.3682	0.3765	0.3930	0.3842
		Center	CIE x	0.3834	CIE y	0.3805
	5000	CIE x	0.3389	0.3519	0.3540	0.3400
		CIE y	0.3414	0.3517	0.3695	0.3580
		Center	CIE x	0.3462	CIE y	0.3551

Notes:

- 1) Chromaticity coordinates refer to ANSI C78.377-2008.
- 2) Samsung maintains ± 0.005 tolerance on Cx, Cy measurements.

3. Structure

a) Appearance

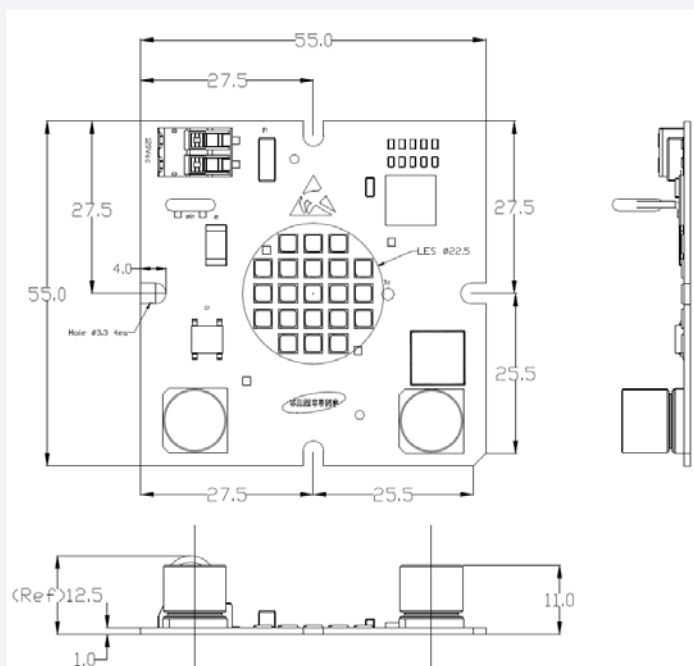

b) Dimension

Number	Item	Dimension	Tolerance	Unit
①	Module Width	55	±0.15	mm
②	Module Height	12.5	±0.5	mm
③	Diameter (LES)	22.5	-	mm
④	Screw Hole Size (M3 screw)	3.3	-	mm
⑤	PCB thickness	1.0	±0.12	mm

c) Structure

Item	Specification
LED	LM302A 21ea
PCB	MPCB
Connector	2-pin
IC	Samsung Electronics IC

d) Thermal Management

Performance temperatures are measured on “Tc point” as indicated on the module.

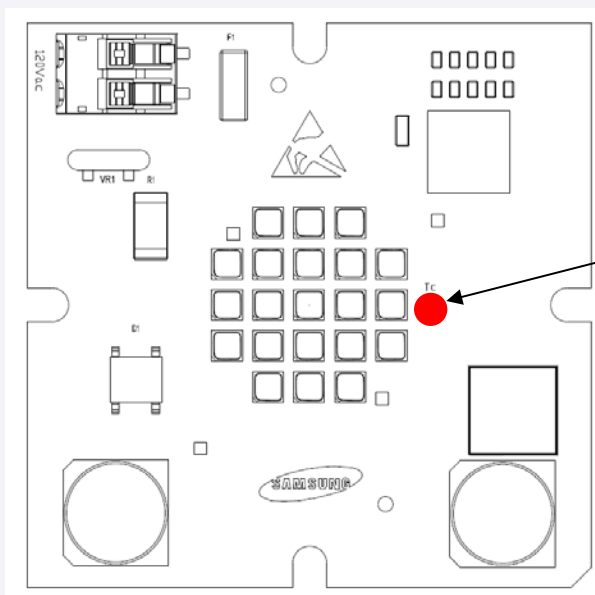

tc point (= tp point)

※ tc : case temperature

4. Certification and Declaration

Item	Compliant to	Remark
Test & Certification	CE	N/A
	ENEC	N/A
	VDE	N/A
	UL / cUL	E344519
	Photobiological Safety	N/A
Declaration	RoHS	Hazardous Substance & Material
	REACH	Hazardous Substance & Material

5. Label Structure

a) Module Label

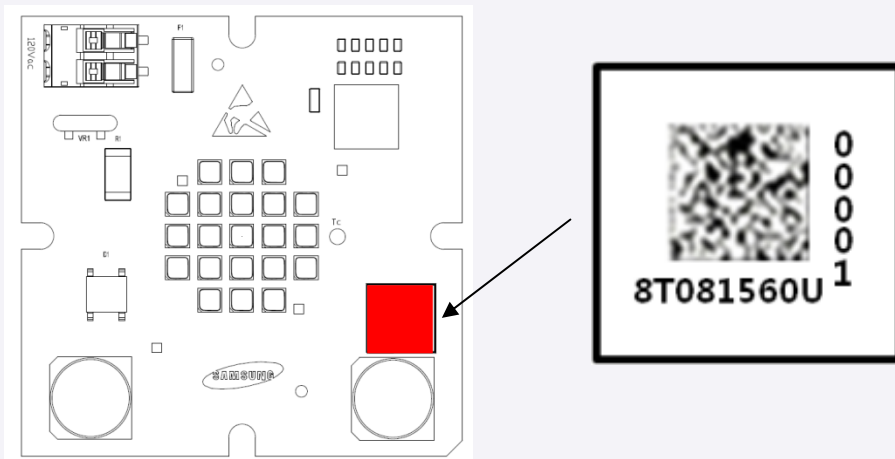

b) Tray Label



Number	Item	ACOM
①	Model Number (Product Code)	Refer to page 3(14 Digits)
②	Lot No.	Total : 14 digits : Packaging Date (8 digits) + Hyphen (1digit) + Production Site (1digit) + Serial No (4 digits) ex) 20140105-E0001
③	QTY	Total Product Quantity (5 digits)
④	Production Date (year & week)	Production Date (4 digits) : Production Year (2 digits) + Production Week (2 digits)
⑤	Label Issue Date	yy/mm/dd
-	Label Size	100 x 50 (mm)

c) Box Label

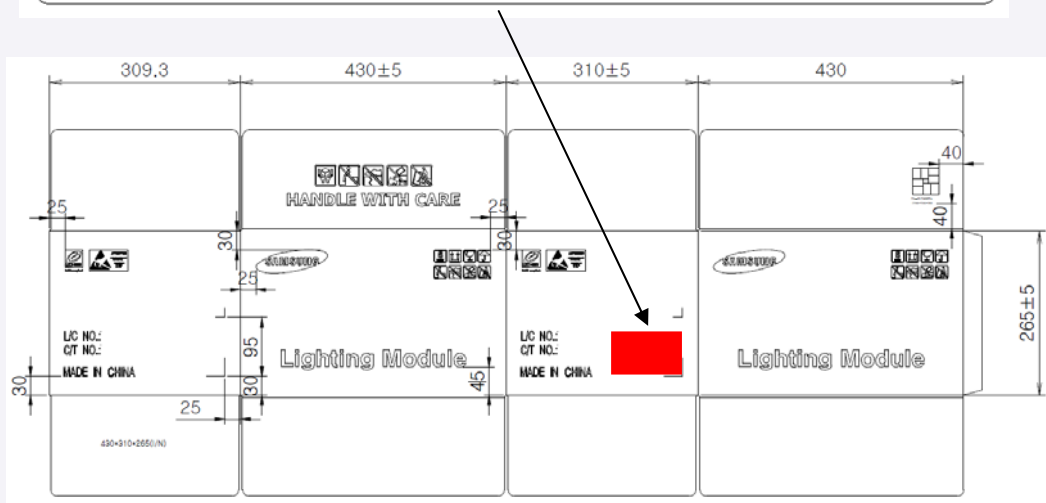
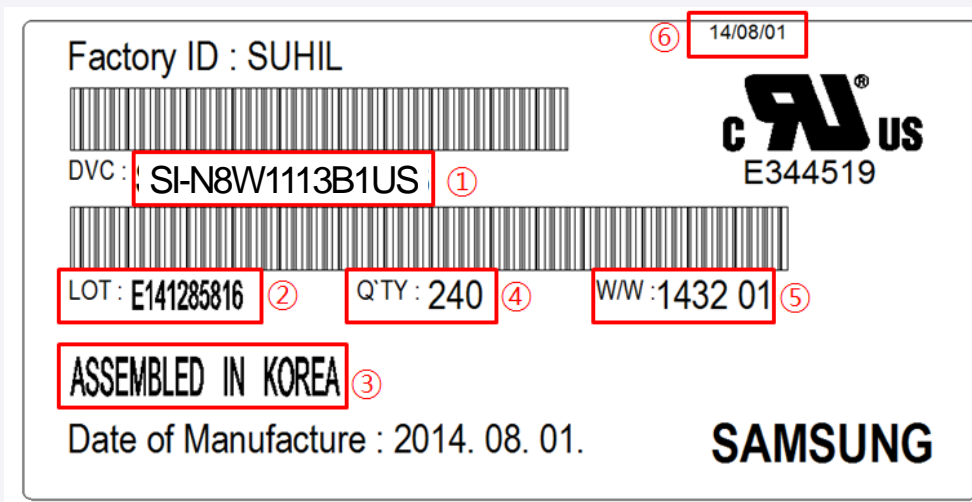

Number	Item	ACOM
①	Model Number (Product Code)	Refer to page 3(14 Digits)
②	Lot No.	- Manufacturer (2 digit) - Packing date (8 digit) - Year(1digit) Month(1digit) Day(2digit) - Serial No.(4digit) . 0001 ~ 9999, A111 ~ A999
③	Manufacturing Country	ASSEMBLED IN KOREA
④	QTY	Total Product Quantity (5 digits)
⑤	Production Date (year & week)	Production Date (4 digits) : Production Year (2 digits) + Production Week (2 digits)
⑥	Label Issue Date	yy/mm/dd
-	Label Size	100 x 50 (mm)

6. Packing Structure

Packing Process

Step 1

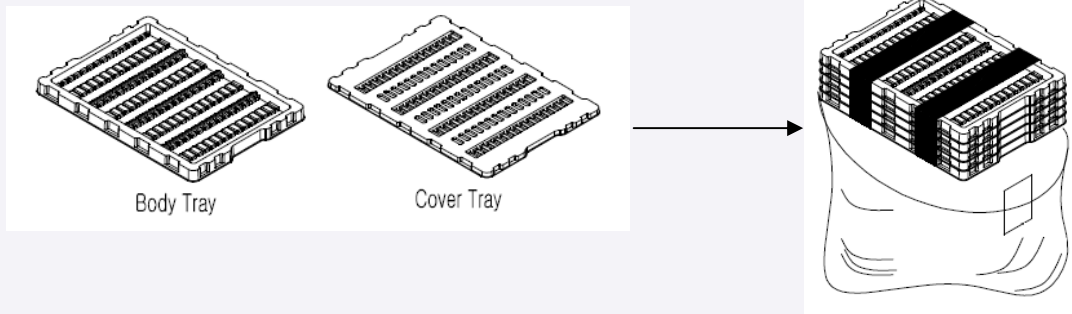

Step 2

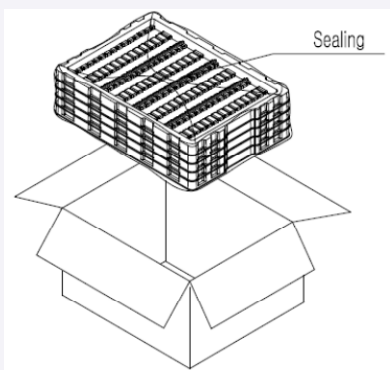

Step 3

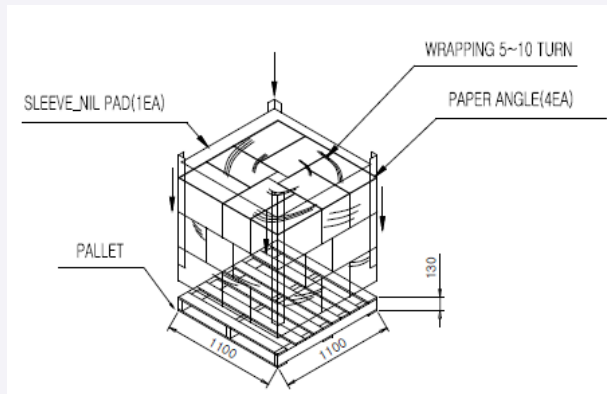

Packing	Quantity (modules)	Dimension (mm)			
		Length	Width	Height	Tolerance
Tray	80	425	305	66.2	±2
Outer Box	320 (4 trays)	430	310	265	±5
Pallet	7680 (24 boxes)	1100	1100	130	-

7. Precautions in Handling & Use

- 1) This LED Module should not be used in any type of fluid such as water, oil, organic solvent, etc. When washing is required, IPA is recommended to use. When using other solvents it should be confirmed beforehand whether the solvents may react with the Module material. The banned freon solvents should not be used. Do not clean using ultrasonic cleaner.
- 2) The LEDs are sensitive to the static electricity and surge. It is recommended to use a wrist band or anti-electrostatic glove when handling the LED Modules. If voltage exceeding the absolute maximum rating is applied to LEDs, it may cause damage or even destruction to LED devices. Damaged LEDs may show some unusual characteristics such as increase in leak current, lowered turn-on voltage, or abnormal lighting of LEDs at low current.
- 3) VOCs (Volatile Organic Compounds) can be generated from adhesives, flux, hardener or organic additives used in luminaires (fixtures). Transparent LED silicone encapsulant is permeable to those chemicals and they may lead a discoloration of encapsulant when they exposed to heat or light. This phenomenon can cause a significant loss of light emitted (output) from the luminaires (fixtures). In order to prevent these problems, we recommend users to know the physical properties of the materials used in luminaires, and they must be selected carefully.
- 4) Risk of sulfurization (or tarnishing)
The LED uses a silver-plated lead frame and its surface color may change to black (or dark colored) when it is exposed to sulfur (S), chlorine (Cl) or other halogen compound. Sulfurization of lead frame may cause intensity degradation, change of chromaticity coordinates and, in extreme cases, open circuit. It requires caution. Due to possible sulfurization of lead frame, the LED Modules should not be used and stored together with oxidizing substances made of materials such as rubber, plain paper, lead solder cream, etc.
- 5) The resin area is very sensitive, please do not handle, press, touch or rub it.
- 6) Do not drop the Module or give shocks.
- 7) Do not store the Module in a dusty place or humid location.
- 8) Do not disassemble the Module.
- 9) Do not directly look into the lighted LED with naked eyes for a long period of time.
- 10) Please consider the creepage and clearance distance at the end product.

Appendix. Applicable wire

a) Applicable wire

Wire Range AWG No.	Number of Conductors/ Diameter of a conductors	Insulation Diameter (mm)	Conductor Type
24	1/0.51	1.35	Solid
22	1/0.64	1.48	
20	1/0.81	1.65	
18	1/1.02	1.86	
22	17/0.76 After soldering : $\Phi 0.9\text{mm Max}$	1.6	Strand
20	21/0.95 After soldering : $\Phi 1.1\text{mm Max}$	1.78	
18	23/1.1 After soldering : $\Phi 1.25\text{mm Max}$	2.21	

b) Wire stripe length

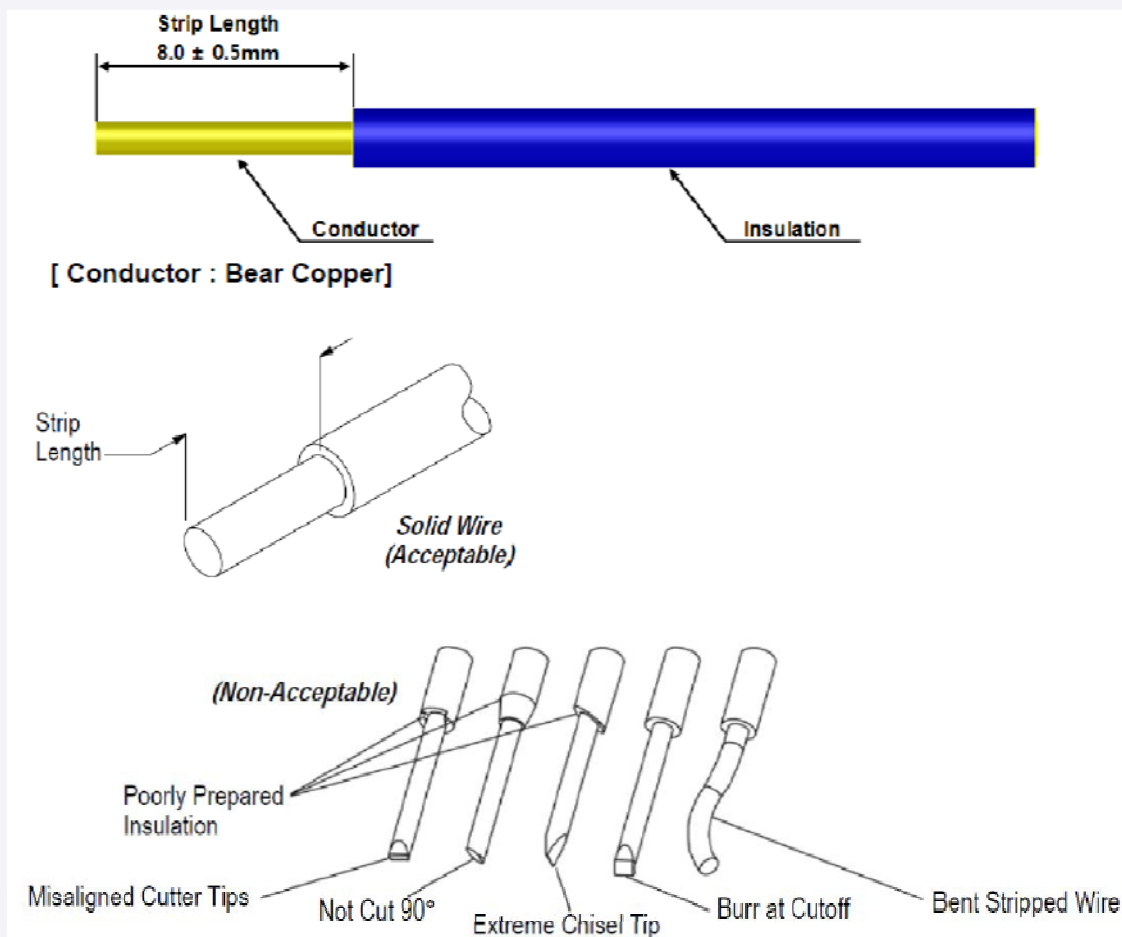

Legal and additional information.

[About Samsung Electronics Co., Ltd.](#)

Samsung Electronics Co., Ltd. is a global leader in technology, opening new possibilities for people everywhere. Through relentless innovation and discovery, we are transforming the worlds of TVs, smartphones, tablets, PCs, cameras, home appliances, printers, LTE systems, medical devices, semiconductors and LED solutions. We employ 286,000 people across 80 countries with annual sales of US\$216.7 billion. To discover more, please visit www.samsungled.com.

Copyright © 2015 Samsung Electronics Co., Ltd. All rights reserved.

Samsung is a registered trademark of Samsung Electronics Co., Ltd.

Specifications and designs are subject to change without notice. Non-metric weights and measurements are approximate. All data were deemed correct at time of creation. Samsung is not liable for errors or omissions. All brand, product, service names and logos are trademarks and/or registered trademarks of their respective owners and are hereby recognized and acknowledged.

Samsung Electronics Co., Ltd.
1, Samsung-ro
Giheung-gu
Yongin-si, Gyeonggi-do, 17113
KOREA

www.samsungled.com





Looking for pricing, stock, or lifecycle information?

Click below to explore more details on WIN SOURCE:

 [View SI-N8W1113B1US](#) on WIN SOURCE

 [Samsung](#) Information

Optimize Your Supply Chain with WIN SOURCE Solutions

-  Global Sourcing Solution
-  Obsolete Management
-  Cost Control Management
-  Shortage Management
-  Alternative Solution
-  Excess Inventory Management