



**THE DATASHEET OF
SPHWAHDNB25YZT3D3**



High Voltage LED Series
Chip on Board

COB D-Gen.3



High efficacy COB LED package
well-suited for use in spotlight applications

Features & Benefits

- Chip on Board (COB) solution makes it easy to design in
- Simple assembly reduces manufacturing cost
- Low thermal resistance
- InGaN/GaN MQW LED with long time reliability

Applications

- Spotlight / Downlight
- LED Retrofit Bulbs
- Outdoor Illumination



Table of Contents

| | | | |
|----|-------------------------------------|-------|----|
| 1. | Characteristics | ----- | 3 |
| 2. | Product Code Information | ----- | 11 |
| 3. | Typical Characteristics Graphs | ----- | 33 |
| 4. | Outline Drawing & Dimension | ----- | 41 |
| 5. | Reliability Test Items & Conditions | ----- | 44 |
| 6. | Label Structure | ----- | 45 |
| 7. | Packing structure | ----- | 46 |
| 8. | Precautions in Handling & Use | ----- | 49 |

1. Characteristics

a) Absolute Maximum Rating

| Item | Symbol | Model | Rating | Unit | Condition |
|-------------------------------------|-------------|--------|--------------|--------|-----------|
| Ambient / Operating Temperature | T_a | - | -40 ~ +105 | °C | - |
| Storage Temperature | T_{stg} | - | -40 ~ +120 | °C | - |
| LED Junction Temperature | T_J | - | 150 | °C | - |
| Case Temperature | T_c | - | 115 | °C | - |
| | | LC003D | 230 / 8.8 | | - |
| | | LC006D | 460 / 17.5 | | - |
| | | LC009D | 690 / 26.3 | | - |
| | | LC013D | 920 / 35.0 | | - |
| | | LC016D | 1150 / 43.8 | | - |
| Forward Current / Power Dissipation | I_F / P_D | LC019D | 1380 / 52.6 | mA / W | - |
| | | LC026D | 1840 / 70.1 | | - |
| | | LC033D | 2300 / 87.6 | | - |
| | | LC040D | 2760 / 105.1 | | - |
| | | LC060D | 2760 / 157.7 | | - |
| | | LC080D | 4140 / 231.3 | | - |
| ESD (HBM) | - | - | ±2 | kV | - |

b) Electro-optical Characteristics (I_F = Sorting Current, $T_J = 85\text{ }^\circ\text{C}$)

| Item | Unit | Model | Rank | Min. | Typ. | Max. | |
|---|--------------------|-----------|------|------|-------------|------|------|
| Forward Voltage (V_F) | V | All model | YZ | 31.0 | 34.0 | 37.0 | |
| | | | 1Z | 60W | 46.8 | 51.0 | 55.2 |
| | | | | 80W | 46.8 | 50.0 | 52.5 |
| Color Rendering Index (R_a) | - | All model | 3 | 70 | - | - | |
| | | | 5 | 80 | - | - | |
| | | | 7 | 90 | - | - | |
| Beam Angle | $^\circ$ | - | - | - | 115 | - | |
| Nominal Power / Sorting Current | W / mA | LC003D | - | - | 3.1 / 90 | - | |
| | | LC006D | - | - | 6.1 / 180 | - | |
| | | LC009D | - | - | 9.2 / 270 | - | |
| | | LC013D | - | - | 12.2 / 360 | - | |
| | | LC016D | - | - | 15.3 / 450 | - | |
| | | LC019D | - | - | 18.4 / 540 | - | |
| | | LC026D | - | - | 24.5 / 720 | - | |
| | | LC033D | - | - | 30.6 / 900 | - | |
| | | LC040D | - | - | 36.7 / 1080 | - | |
| | | LC060D | - | - | 55.1 / 1080 | - | |
| | | LC080D | - | - | 81.0 / 1620 | - | |
| Thermal Resistance (Junction to chip case) | $^\circ\text{C/W}$ | LC003D | - | - | 2.43 | - | |
| | | LC006D | - | - | 1.41 | - | |
| | | LC009D | - | - | 0.94 | - | |
| | | LC013D | - | - | 0.81 | - | |
| | | LC016D | - | - | 0.64 | - | |
| | | LC019D | - | - | 0.57 | - | |
| | | LC026D | - | - | 0.45 | - | |
| | | LC033D | - | - | 0.38 | - | |
| | | LC040D | - | - | 0.30 | - | |
| | | LC060D | - | - | 0.23 | - | |
| | | LC080D | - | - | 0.15 | - | |

Notes:

- 1) The COB is tested in pulsed condition at rated test current (10 ms pulse width) and rated temperature ($T_J = T_C = T_a = 85\text{ }^\circ\text{C}$)
- 2) Samsung maintains measurement tolerance of: forward voltage = $\pm 5\%$, CRI = ± 1
- 3) Refer to the derating curve, '3. Typical Characteristics Graph'designed within the range.

c) Luminous Flux Characteristics (I_F = Sorting Current)

| Model | CRI (R _a) Min. | Nominal CCT (K) | Flux Rank | Flux@ T _J = 85 °C (lm) | | | |
|--------|-------------------------------|--------------------|--------------|-----------------------------------|------|------|---|
| | | | | Min. | Typ. | Max. | |
| LC003D | 80 | 2700 | D3 | 451 | 475 | - | |
| | | 3000 | D3 | 474 | 499 | - | |
| | | 3500 | D3 | 488 | 514 | - | |
| | | 4000 | D3 | 498 | 524 | - | |
| | | 5000 | D3 | 502 | 529 | - | |
| | | 5700 | D3 | 502 | 529 | - | |
| | | 6500 | D3 | 498 | 524 | - | |
| | 90 | 2700 | D3 | 386 | 407 | - | |
| | | 3000 | D3 | 406 | 428 | - | |
| | | 3500 | D3 | 419 | 441 | - | |
| | | 4000 | D3 | 427 | 450 | - | |
| | | 5000 | D3 | 431 | 453 | - | |
| | | 80 | 2700 | D3 | 898 | 946 | - |
| | | | 3000 | D3 | 944 | 994 | - |
| 3500 | D3 | | 972 | 1023 | - | | |
| 4000 | D3 | | 991 | 1043 | - | | |
| 5000 | D3 | | 1000 | 1052 | - | | |
| 5700 | D3 | | 1000 | 1052 | - | | |
| 6500 | D3 | | 991 | 1043 | - | | |
| LC006D | 90 | 2700 | D3 | 769 | 809 | - | |
| | | 3000 | D3 | 809 | 851 | - | |
| | | 3500 | D3 | 833 | 877 | - | |
| | | 4000 | D3 | 850 | 895 | - | |
| | | 5000 | D3 | 857 | 902 | - | |

Notes:

- 1) The COB is tested in pulsed operating condition at rated test current (10 ms pulse width) and rated temperature (T_J = T_C = 85 °C).
- 2) Samsung maintains measurement tolerance of: Luminous flux = ±7 %, CRI = ±1

| Model | CRI (Ra) Min. | Nominal CCT (K) | Flux Rank | Flux@ T _J = 85 °C (lm) | | |
|--------|------------------|--------------------|--------------|-----------------------------------|------|------|
| | | | | Min. | Typ. | Max. |
| LC009D | 70 | 3000 | D3 | 1515 | 1594 | - |
| | | 4000 | D3 | 1543 | 1624 | - |
| | | 5000 | D3 | 1571 | 1653 | - |
| | 80 | 2700 | D3 | 1334 | 1405 | - |
| | | 3000 | D3 | 1402 | 1476 | - |
| | | 3500 | D3 | 1443 | 1519 | - |
| | | 4000 | D3 | 1472 | 1550 | - |
| | | 5000 | D3 | 1485 | 1563 | - |
| | | 5700 | D3 | 1485 | 1563 | - |
| | | 6500 | D3 | 1472 | 1550 | - |
| | | 2700 | D3 | 1142 | 1202 | - |
| | | 3000 | D3 | 1201 | 1264 | - |
| | 90 | 3500 | D3 | 1237 | 1302 | - |
| | | 4000 | D3 | 1263 | 1329 | - |
| | | 5000 | D3 | 1273 | 1340 | - |
| LC013D | 70 | 3000 | D3 | 1989 | 2094 | - |
| | | 4000 | D3 | 2026 | 2133 | - |
| | | 5000 | D3 | 2063 | 2171 | - |
| | 80 | 2700 | D3 | 1753 | 1845 | - |
| | | 3000 | D3 | 1842 | 1939 | - |
| | | 3500 | D3 | 1896 | 1996 | - |
| | | 4000 | D3 | 1934 | 2036 | - |
| | | 5000 | D3 | 1950 | 2053 | - |
| | | 5700 | D3 | 1950 | 2053 | - |
| | | 6500 | D3 | 1934 | 2036 | - |
| | | 2700 | D3 | 1500 | 1579 | - |
| | | 3000 | D3 | 1578 | 1661 | - |
| | 90 | 3500 | D3 | 1625 | 1710 | - |
| | | 4000 | D3 | 1658 | 1745 | - |
| | | 5000 | D3 | 1672 | 1760 | - |

Notes:

- 2) The COB is tested in pulsed operating condition at rated test current (10 ms pulse width) and rated temperature (T_J = T_C = 85 °C).
- 2) Samsung maintains measurement tolerance of: Luminous flux = ±7 %, CRI = ±1

| Model | CRI (R _a) Min. | Nominal CCT (K) | Flux Rank | Flux@ T _J = 85 °C (lm) | | |
|--------|-------------------------------|--------------------|--------------|-----------------------------------|------|------|
| | | | | Min. | Typ. | Max. |
| LC016D | 70 | 3000 | D3 | 2562 | 2697 | - |
| | | 4000 | D3 | 2609 | 2747 | - |
| | | 5000 | D3 | 2657 | 2797 | - |
| | 80 | 2700 | D3 | 2257 | 2376 | - |
| | | 3000 | D3 | 2372 | 2497 | - |
| | | 3500 | D3 | 2442 | 2570 | - |
| | | 4000 | D3 | 2490 | 2622 | - |
| | | 5000 | D3 | 2511 | 2644 | - |
| | | 5700 | D3 | 2511 | 2644 | - |
| | | 6500 | D3 | 2490 | 2622 | - |
| | | 2700 | D3 | 1932 | 2033 | - |
| | | 3000 | D3 | 2032 | 2139 | - |
| | 90 | 3500 | D3 | 2093 | 2203 | - |
| | | 4000 | D3 | 2136 | 2248 | - |
| | | 5000 | D3 | 2154 | 2267 | - |
| 70 | | 3000 | D3 | 3059 | 3220 | - |
| | | 4000 | D3 | 3116 | 3280 | - |
| | 5000 | D3 | 3172 | 3339 | - | |
| LC019D | 80 | 2700 | D3 | 2695 | 2837 | - |
| | | 3000 | D3 | 2833 | 2982 | - |
| | | 3500 | D3 | 2916 | 3069 | - |
| | | 4000 | D3 | 2974 | 3130 | - |
| | | 5000 | D3 | 2999 | 3157 | - |
| | 90 | 5700 | D3 | 2999 | 3157 | - |
| | | 6500 | D3 | 2974 | 3130 | - |
| | | 2700 | D3 | 2307 | 2428 | - |
| | | 3000 | D3 | 2426 | 2554 | - |
| | | 3500 | D3 | 2499 | 2630 | - |
| 90 | 4000 | D3 | 2550 | 2684 | - | |
| | 5000 | D3 | 2572 | 2707 | - | |

Notes:

- 3) The COB is tested in pulsed operating condition at rated test current (10 ms pulse width) and rated temperature (T_J = T_C = 85 °C).
- 2) Samsung maintains measurement tolerance of: Luminous flux = ±7 %, CRI = ±1

| Model | CRI (R _a) Min. | Nominal CCT (K) | Flux Rank | Flux@ T _J = 85 °C (lm) | | | |
|--------|-------------------------------|--------------------|--------------|-----------------------------------|------|------|---|
| | | | | Min. | Typ. | Max. | |
| LC026D | 70 | 3000 | D3 | 4019 | 4230 | - | |
| | | 4000 | D3 | 4093 | 4308 | - | |
| | | 5000 | D3 | 4167 | 4387 | - | |
| | 80 | 2700 | D3 | 3541 | 3727 | - | |
| | | 3000 | D3 | 3721 | 3917 | - | |
| | | 3500 | D3 | 3830 | 4032 | - | |
| | | 4000 | D3 | 3907 | 4112 | - | |
| | | 5000 | D3 | 3939 | 4147 | - | |
| | | 5700 | D3 | 3939 | 4147 | - | |
| | | 6500 | D3 | 3907 | 4112 | - | |
| | | 90 | 2700 | D3 | 3030 | 3190 | - |
| | | | 3000 | D3 | 3187 | 3355 | - |
| | 3500 | | D3 | 3282 | 3455 | - | |
| | LC033D | 70 | 4000 | D3 | 3350 | 3526 | - |
| | | | 5000 | D3 | 3379 | 3556 | - |
| 3000 | | | D3 | 4973 | 5235 | - | |
| 80 | | 4000 | D3 | 5065 | 5332 | - | |
| | | 5000 | D3 | 5157 | 5429 | - | |
| | | 2700 | D3 | 4382 | 4612 | - | |
| | | 3000 | D3 | 4605 | 4847 | - | |
| | | 3500 | D3 | 4740 | 4989 | - | |
| | | 4000 | D3 | 4834 | 5089 | - | |
| | | 5000 | D3 | 4875 | 5132 | - | |
| | | 5700 | D3 | 4875 | 5132 | - | |
| | | 6500 | D3 | 4834 | 5089 | - | |
| 90 | | 2700 | D3 | 3750 | 3947 | - | |
| | | 3000 | D3 | 3944 | 4152 | - | |
| | | 3500 | D3 | 4062 | 4276 | - | |
| | 4000 | D3 | 4146 | 4364 | - | | |
| | 5000 | D3 | 4181 | 4401 | - | | |

Notes:

- 4) The COB is tested in pulsed operating condition at rated test current (10 ms pulse width) and rated temperature (T_J = T_C = 85 °C).
- 2) Samsung maintains measurement tolerance of: Luminous flux = ±7 %, CRI = ±1

| Model | CRI (R _a) Min. | Nominal CCT (K) | Flux Rank | Flux@ T _J = 85 °C (lm) | | |
|--------|-------------------------------|--------------------|--------------|-----------------------------------|------|------|
| | | | | Min. | Typ. | Max. |
| LC040D | 70 | 3000 | D3 | 6118 | 6440 | - |
| | | 4000 | D3 | 6232 | 6560 | - |
| | | 5000 | D3 | 6345 | 6679 | - |
| | 80 | 2700 | D3 | 5391 | 5675 | - |
| | | 3000 | D3 | 5665 | 5963 | - |
| | | 3500 | D3 | 5831 | 6138 | - |
| | | 4000 | D3 | 5948 | 6261 | - |
| | | 5000 | D3 | 5998 | 6313 | - |
| | | 5700 | D3 | 5998 | 6313 | - |
| | 90 | 6500 | D3 | 5948 | 6261 | - |
| | | 2700 | D3 | 4614 | 4856 | - |
| | | 3000 | D3 | 4853 | 5108 | - |
| | | 3500 | D3 | 4997 | 5260 | - |
| | | 4000 | D3 | 5100 | 5369 | - |
| | LC060D | 70 | 5000 | D3 | 5144 | 5415 |
| 3000 | | | D3 | 9042 | 9518 | - |
| 4000 | | | D3 | 9209 | 9694 | - |
| 80 | | 5000 | D3 | 9377 | 9870 | - |
| | | 2700 | D3 | 7967 | 8386 | - |
| | | 3000 | D3 | 8372 | 8813 | - |
| | | 3500 | D3 | 8617 | 9071 | - |
| | | 4000 | D3 | 8790 | 9253 | - |
| | | 5000 | D3 | 8864 | 9330 | - |
| 90 | | 5700 | D3 | 8864 | 9330 | - |
| | | 6500 | D3 | 8790 | 9253 | - |
| | | 2700 | D3 | 6818 | 7177 | - |
| | | 3000 | D3 | 7172 | 7549 | - |
| | | 3500 | D3 | 7385 | 7774 | - |
| | | | 4000 | D3 | 7537 | 7934 |
| | | 5000 | D3 | 7602 | 8002 | - |

Notes:

- 5) The COB is tested in pulsed operating condition at rated test current (10 ms pulse width) and rated temperature (T_J = T_C = 85 °C).
- 2) Samsung maintains measurement tolerance of: Luminous flux = ±7 %, CRI = ±1

| Model | CRI (Ra) Min. | Nominal CCT (K) | Flux Rank | Flux@ T _J = 85 °C (lm) | | | |
|--------|------------------|--------------------|--------------|-----------------------------------|-------|-------|---|
| | | | | Min. | Typ. | Max. | |
| LC080D | 70 | 3000 | D3 | 13409 | 14115 | - | |
| | | 4000 | D3 | 13657 | 14376 | - | |
| | | 5000 | D3 | 13906 | 14637 | - | |
| | 80 | 2700 | D3 | 11815 | 12437 | - | |
| | | 3000 | D3 | 12416 | 13069 | - | |
| | | 3500 | D3 | 12779 | 13452 | - | |
| | | 4000 | D3 | 13035 | 13721 | - | |
| | | 5000 | D3 | 13144 | 13836 | - | |
| | | 5700 | D3 | 13144 | 13836 | - | |
| | 90 | 6500 | D3 | 13035 | 13721 | - | |
| | | 2700 | D3 | 10111 | 10643 | - | |
| | | 3000 | D3 | 10635 | 11195 | - | |
| | | 3500 | D3 | 10952 | 11529 | - | |
| | | 4000 | D3 | 11178 | 11766 | - | |
| | | | 5000 | D3 | 11273 | 11867 | - |

Notes:

- 6) The COB is tested in pulsed operating condition at rated test current (10 ms pulse width) and rated temperature (T_J = T_C = 85 °C).
- 2) Samsung maintains measurement tolerance of: Luminous flux = ±7 %, CRI = ±1

2. Product Code Information

| | | | | | | | | | | | | | | | | | |
|---|---|---|---|---|---|---|---|---|----|----|----|----|----|----|----|----|----|
| 1 | 2 | 3 | 4 | 5 | 6 | 7 | 8 | 9 | 10 | 11 | 12 | 13 | 14 | 15 | 16 | 17 | 18 |
| S | P | H | W | H | A | H | D | N | G | 2 | 5 | Y | Z | W | 3 | D | 3 |

| Digit | PKG Information | Code | Specification |
|-------|----------------------------|--|--|
| 1 2 3 | Samsung Package High Power | SPH | |
| 4 5 | Color | WH | White |
| 6 | Product Version | A | |
| 7 8 | Form Factor | HD | COB |
| 9 | Lens Type | N | No lens |
| 10 | Wattage or Model | A B C D E F G H K L M | LC003D LC006D LC009D LC013D LC016D LC019D LC026D LC033D LC040D LC060D LC080D |
| 11 | Internal Code | 2 | |
| 12 | CRI & Sorting Temperature | 3 5 7 | Min. 70 (85°C) Min. 80 (85°C) Min. 90 (85°C) |
| 13 14 | Forward Voltage (V) | YZ 1Z | 31.0~37.0 46.8~55.2 (60W) 46.8~52.5 (80W) |
| 15 | CCT (K) | W V U T R Q P | 2700K 3000K 3500K 4000K 5000K 5700K 6500K |
| 16 | MacAdam Step | 1 2 3 | MacAdam 1-step MacAdam 2-step MacAdam 3-step |
| 17 18 | Luminous Flux (Lm) | D3 | COB D-series Gen.3 level |

a) Binning Structure

※ LCoo_3D ($I_f = 90 \text{ mA}$, $T_j = 85 \text{ }^\circ\text{C}$)

| CRI(R_a) Min. | Nominal CCT(K) | Product Code | V_f Rank | Color Rank | Flux Rank | Flux Range (Φ_v , lm) | |
|----------------------|-------------------|-------------------|-------------------|---------------|--------------|--------------------------------|-------|
| 80 | 2700 | SPHWAHDNA25YZW1D3 | YZ | W1 | D3 | 451 ~ | |
| | | SPHWAHDNA25YZW2D3 | | W2 | | | |
| | 3000 | SPHWAHDNA25YZV1D3 | YZ | V1 | D3 | 474 ~ | |
| | | SPHWAHDNA25YZV2D3 | | V2 | | | |
| | 3500 | SPHWAHDNA25YZU1D3 | YZ | U1 | D3 | 488 ~ | |
| | | SPHWAHDNA25YZU2D3 | | U2 | | | |
| | 4000 | SPHWAHDNA25YZT1D3 | YZ | T1 | D3 | 498 ~ | |
| | | SPHWAHDNA25YZT2D3 | | T2 | | | |
| | 5000 | SPHWAHDNA25YZR2D3 | YZ | R2 | D3 | 502 ~ | |
| | | SPHWAHDNA25YZR3D3 | | R3 | | | |
| | 5700 | SPHWAHDNA25YZQ2D3 | YZ | Q2 | D3 | 502 ~ | |
| | | SPHWAHDNA25YZQ3D3 | | Q3 | | | |
| | 6500 | SPHWAHDNA25YZP2D3 | YZ | P2 | D3 | 498 ~ | |
| | | SPHWAHDNA25YZP3D3 | | P3 | | | |
| | 90 | 2700 | SPHWAHDNA27YZW1D3 | YZ | W1 | D3 | 386 ~ |
| | | | SPHWAHDNA27YZW2D3 | | W2 | | |
| 3000 | | SPHWAHDNA27YZV1D3 | YZ | V1 | D3 | 406 ~ | |
| | | SPHWAHDNA27YZV2D3 | | V2 | | | |
| 3500 | | SPHWAHDNA27YZU1D3 | YZ | U1 | D3 | 419 ~ | |
| | | SPHWAHDNA27YZU2D3 | | U2 | | | |
| 4000 | | SPHWAHDNA27YZT1D3 | YZ | T1 | D3 | 427 ~ | |
| | | SPHWAHDNA27YZT2D3 | | T2 | | | |
| 5000 | | SPHWAHDNA27YZR2D3 | YZ | R2 | D3 | 431 ~ | |
| | | SPHWAHDNA27YZR3D3 | | R3 | | | |

※ LCoo6D(I_F = 180 mA, T_J = 85 °C)

| CRI(R _a) Min. | Nominal CCT(K) | Product Code | V _F Rank | Color Rank | Flux Rank | Flux Range (Φ _v , lm) | |
|------------------------------|-------------------|-------------------|------------------------|---------------|--------------|-------------------------------------|-------|
| 80 | 2700 | SPHWAHDNB25YZW1D3 | YZ | W1 | D3 | 898 ~ | |
| | | SPHWAHDNB25YZW2D3 | | W2 | | | |
| | 3000 | SPHWAHDNB25YZV1D3 | YZ | V1 | D3 | 944 ~ | |
| | | SPHWAHDNB25YZV2D3 | | V2 | | | |
| | 3500 | SPHWAHDNB25YZU1D3 | YZ | U1 | D3 | 972 ~ | |
| | | SPHWAHDNB25YZU2D3 | | U2 | | | |
| | 4000 | SPHWAHDNB25YZT1D3 | YZ | T1 | D3 | 991 ~ | |
| | | SPHWAHDNB25YZT2D3 | | T2 | | | |
| | 5000 | SPHWAHDNB25YZR2D3 | YZ | R2 | D3 | 1000 ~ | |
| | | SPHWAHDNB25YZR3D3 | | R3 | | | |
| | 5700 | SPHWAHDNB25YZQ2D3 | YZ | Q2 | D3 | 1000 ~ | |
| | | SPHWAHDNB25YZQ3D3 | | Q3 | | | |
| | 6500 | SPHWAHDNB25YZP2D3 | YZ | P2 | D3 | 991 ~ | |
| | | SPHWAHDNB25YZP3D3 | | P3 | | | |
| | 90 | 2700 | SPHWAHDNB27YZW1D3 | YZ | W1 | D3 | 769 ~ |
| | | | SPHWAHDNB27YZW2D3 | | W2 | | |
| 3000 | | SPHWAHDNB27YZV1D3 | YZ | V1 | D3 | 809 ~ | |
| | | SPHWAHDNB27YZV2D3 | | V2 | | | |
| 3500 | | SPHWAHDNB27YZU1D3 | YZ | U1 | D3 | 833 ~ | |
| | | SPHWAHDNB27YZU2D3 | | U2 | | | |
| 4000 | | SPHWAHDNB27YZT1D3 | YZ | T1 | D3 | 850 ~ | |
| | | SPHWAHDNB27YZT2D3 | | T2 | | | |
| 5000 | | SPHWAHDNB27YZR2D3 | YZ | R2 | D3 | 857 ~ | |
| | | SPHWAHDNB27YZR3D3 | | R3 | | | |

※ LCoogD(I_F = 270 mA, T_J = 85 °C)

| CRI(R _a) Min. | Nominal CCT(K) | Product Code | V _F Rank | Color Rank | Flux Rank | Flux Range (Φ _v , lm) | |
|------------------------------|-------------------|--------------------|------------------------|---------------|--------------|-------------------------------------|--------|
| 70 | 3000 | SPHWWAHDNC23YZV2D3 | YZ | V2 | D3 | 1515 ~ | |
| | | SPHWWAHDNC23YZV3D3 | | V3 | | | |
| | 4000 | SPHWWAHDNC23YZT2D3 | YZ | T2 | D3 | 1543 ~ | |
| | | SPHWWAHDNC23YZT3D3 | | T3 | | | |
| | 5000 | SPHWWAHDNC23YZR2D3 | YZ | R2 | D3 | 1571 ~ | |
| | | SPHWWAHDNC23YZR3D3 | | R3 | | | |
| 80 | 2700 | SPHWWAHDNC25YZW1D3 | YZ | W1 | D3 | 1334 ~ | |
| | | SPHWWAHDNC25YZW2D3 | | W2 | | | |
| | 3000 | SPHWWAHDNC25YZV1D3 | YZ | V1 | D3 | 1402 ~ | |
| | | SPHWWAHDNC25YZV2D3 | | V2 | | | |
| | 3500 | SPHWWAHDNC25YZU1D3 | YZ | U1 | D3 | 1443 ~ | |
| | | SPHWWAHDNC25YZU2D3 | | U2 | | | |
| | 4000 | SPHWWAHDNC25YZT1D3 | YZ | T1 | D3 | 1472 ~ | |
| | | SPHWWAHDNC25YZT2D3 | | T2 | | | |
| | 5000 | SPHWWAHDNC25YZR2D3 | YZ | R2 | D3 | 1485 ~ | |
| | | SPHWWAHDNC25YZR3D3 | | R3 | | | |
| | 5700 | SPHWWAHDNC25YZQ2D3 | YZ | Q2 | D3 | 1485 ~ | |
| | | SPHWWAHDNC25YZQ3D3 | | Q3 | | | |
| | 6500 | SPHWWAHDNC25YZP2D3 | YZ | P2 | D3 | 1472 ~ | |
| | | SPHWWAHDNC25YZP3D3 | | P3 | | | |
| | 90 | 2700 | SPHWWAHDNC27YZW1D3 | YZ | W1 | D3 | 1142 ~ |
| | | | SPHWWAHDNC27YZW2D3 | | W2 | | |
| | | 3000 | SPHWWAHDNC27YZV1D3 | YZ | V1 | D3 | 1201 ~ |
| | | | SPHWWAHDNC27YZV2D3 | | V2 | | |

| | | | | | | |
|--|------|-------------------|----|----|----|--------|
| | | SPHWAHDNC27YZU1D3 | | U1 | | |
| | 3500 | SPHWAHDNC27YZU2D3 | YZ | U2 | D3 | 1237 ~ |
| | | | | | | |
| | | SPHWAHDNC27YZT1D3 | | T1 | | |
| | 4000 | SPHWAHDNC27YZT2D3 | YZ | T2 | D3 | 1263 ~ |
| | | | | | | |
| | | SPHWAHDNC27YZR2D3 | | R2 | | |
| | 5000 | SPHWAHDNC27YZR3D3 | YZ | R3 | D3 | 1273 ~ |

90

※ LCo13D(I_F = 360 mA, T_J = 85 °C)

| CRI(R _a) Min. | Nominal CCT(K) | Product Code | V _F Rank | Color Rank | Flux Rank | Flux Range (Φ _v , lm) | |
|------------------------------|-------------------|--------------------|------------------------|---------------|--------------|-------------------------------------|--------|
| 70 | 3000 | SPHWWAHDND23YZV2D3 | YZ | V2 | D3 | 1989 ~ | |
| | | SPHWWAHDND23YZV3D3 | | V3 | | | |
| | 4000 | SPHWWAHDND23YZT2D3 | YZ | T2 | D3 | 2026 ~ | |
| | | SPHWWAHDND23YZT3D3 | | T3 | | | |
| | 5000 | SPHWWAHDND23YZR2D3 | YZ | R2 | D3 | 2063 ~ | |
| | | SPHWWAHDND23YZR3D3 | | R3 | | | |
| 80 | 2700 | SPHWWAHDND25YZW1D3 | YZ | W1 | D3 | 1753 ~ | |
| | | SPHWWAHDND25YZW2D3 | | W2 | | | |
| | 3000 | SPHWWAHDND25YZV1D3 | YZ | V1 | D3 | 1842 ~ | |
| | | SPHWWAHDND25YZV2D3 | | V2 | | | |
| | 3500 | SPHWWAHDND25YZU1D3 | YZ | U1 | D3 | 1896 ~ | |
| | | SPHWWAHDND25YZU2D3 | | U2 | | | |
| | 4000 | SPHWWAHDND25YZT1D3 | YZ | T1 | D3 | 1934 ~ | |
| | | SPHWWAHDND25YZT2D3 | | T2 | | | |
| | 5000 | SPHWWAHDND25YZR2D3 | YZ | R2 | D3 | 1950 ~ | |
| | | SPHWWAHDND25YZR3D3 | | R3 | | | |
| | 5700 | SPHWWAHDND25YZQ2D3 | YZ | Q2 | D3 | 1950 ~ | |
| | | SPHWWAHDND25YZQ3D3 | | Q3 | | | |
| | 6500 | SPHWWAHDND25YZP2D3 | YZ | P2 | D3 | 1934 ~ | |
| | | SPHWWAHDND25YZP3D3 | | P3 | | | |
| | 90 | 2700 | SPHWWAHDND27YZW1D3 | YZ | W1 | D3 | 1500 ~ |
| | | | SPHWWAHDND27YZW2D3 | | W2 | | |
| | | 3000 | SPHWWAHDND27YZV1D3 | YZ | V1 | D3 | 1578 ~ |
| | | | SPHWWAHDND27YZV2D3 | | V2 | | |

| | | | | | | |
|----|------|-------------------|----|----|----|--------|
| | | SPHWAHDND27YZU1D3 | | U1 | | |
| | 3500 | SPHWAHDND27YZU2D3 | YZ | U2 | D3 | 1625 ~ |
| | | | | | | |
| | | SPHWAHDND27YZT1D3 | | T1 | | |
| | 4000 | SPHWAHDND27YZT2D3 | YZ | T2 | D3 | 1658 ~ |
| | | | | | | |
| | | SPHWAHDND27YZR2D3 | | R2 | | |
| 90 | 5000 | SPHWAHDND27YZR3D3 | YZ | R3 | D3 | 1672 ~ |

※ LCo16D(I_F = 450 mA, T_J = 85 °C)

| CRI(R _a) Min. | Nominal CCT(K) | Product Code | V _F Rank | Color Rank | Flux Rank | Flux Range (Φ _v , lm) | |
|------------------------------|-------------------|--------------------|------------------------|---------------|--------------|-------------------------------------|--------|
| 70 | 3000 | SPHWWAHDNE23YZV2D3 | YZ | V2 | D3 | 2562 ~ | |
| | | SPHWWAHDNE23YZV3D3 | | V3 | | | |
| | 4000 | SPHWWAHDNE23YZT2D3 | YZ | T2 | D3 | 2609 ~ | |
| | | SPHWWAHDNE23YZT3D3 | | T3 | | | |
| | 5000 | SPHWWAHDNE23YZR2D3 | YZ | R2 | D3 | 2657 ~ | |
| | | SPHWWAHDNE23YZR3D3 | | R3 | | | |
| 80 | 2700 | SPHWWAHDNE25YZW1D3 | YZ | W1 | D3 | 2257 ~ | |
| | | SPHWWAHDNE25YZW2D3 | | W2 | | | |
| | 3000 | SPHWWAHDNE25YZV1D3 | YZ | V1 | D3 | 2372 ~ | |
| | | SPHWWAHDNE25YZV2D3 | | V2 | | | |
| | 3500 | SPHWWAHDNE25YZU1D3 | YZ | U1 | D3 | 2442 ~ | |
| | | SPHWWAHDNE25YZU2D3 | | U2 | | | |
| | 4000 | SPHWWAHDNE25YZT1D3 | YZ | T1 | D3 | 2490 ~ | |
| | | SPHWWAHDNE25YZT2D3 | | T2 | | | |
| | 5000 | SPHWWAHDNE25YZR2D3 | YZ | R2 | D3 | 2511 ~ | |
| | | SPHWWAHDNE25YZR3D3 | | R3 | | | |
| | 5700 | SPHWWAHDNE25YZQ2D3 | YZ | Q2 | D3 | 2511 ~ | |
| | | SPHWWAHDNE25YZQ3D3 | | Q3 | | | |
| | 6500 | SPHWWAHDNE25YZP2D3 | YZ | P2 | D3 | 2490 ~ | |
| | | SPHWWAHDNE25YZP3D3 | | P3 | | | |
| | 90 | 2700 | SPHWWAHDNE27YZW1D3 | YZ | W1 | D3 | 1932 ~ |
| | | | SPHWWAHDNE27YZW2D3 | | W2 | | |
| | | 3000 | SPHWWAHDNE27YZV1D3 | YZ | V1 | D3 | 2032 ~ |
| | | | SPHWWAHDNE27YZV2D3 | | V2 | | |

| | | | | | | |
|----|------|-------------------|----|-------|----|--------|
| | | SPHWAHDNE27YZU1D3 | | U1 | | |
| | 3500 | ----- | YZ | ----- | D3 | 2093 ~ |
| | | SPHWAHDNE27YZU2D3 | | U2 | | |
| | | ----- | | ----- | | |
| | | SPHWAHDNE27YZT1D3 | | T1 | | |
| 90 | 4000 | ----- | YZ | ----- | D3 | 2136 ~ |
| | | SPHWAHDNE27YZT2D3 | | T2 | | |
| | | ----- | | ----- | | |
| | | SPHWAHDNE27YZR2D3 | | R2 | | |
| | 5000 | ----- | YZ | ----- | D3 | 2154 ~ |
| | | SPHWAHDNE27YZR3D3 | | R3 | | |

※ LCo19D(I_F = 540 mA, T_J = 85 °C)

| CRI(R _a) Min. | Nominal CCT(K) | Product Code | V _F Rank | Color Rank | Flux Rank | Flux Range (Φ _v , lm) | |
|------------------------------|-------------------|--------------------|------------------------|---------------|--------------|-------------------------------------|--------|
| 70 | 3000 | SPHWWAHDNF23YZV2D3 | YZ | V2 | D3 | 3059 ~ | |
| | | SPHWWAHDNF23YZV3D3 | | V3 | | | |
| | 4000 | SPHWWAHDNF23YZT2D3 | YZ | T2 | D3 | 3116 ~ | |
| | | SPHWWAHDNF23YZT3D3 | | T3 | | | |
| | 5000 | SPHWWAHDNF23YZR2D3 | YZ | R2 | D3 | 3172 ~ | |
| | | SPHWWAHDNF23YZR3D3 | | R3 | | | |
| 80 | 2700 | SPHWWAHDNF25YZW1D3 | YZ | W1 | D3 | 2695 ~ | |
| | | SPHWWAHDNF25YZW2D3 | | W2 | | | |
| | 3000 | SPHWWAHDNF25YZV1D3 | YZ | V1 | D3 | 2833 ~ | |
| | | SPHWWAHDNF25YZV2D3 | | V2 | | | |
| | 3500 | SPHWWAHDNF25YZU1D3 | YZ | U1 | D3 | 2916 ~ | |
| | | SPHWWAHDNF25YZU2D3 | | U2 | | | |
| | 4000 | SPHWWAHDNF25YZT1D3 | YZ | T1 | D3 | 2974 ~ | |
| | | SPHWWAHDNF25YZT2D3 | | T2 | | | |
| | 5000 | SPHWWAHDNF25YZR2D3 | YZ | R2 | D3 | 2999 ~ | |
| | | SPHWWAHDNF25YZR3D3 | | R3 | | | |
| | 5700 | SPHWWAHDNF25YZQ2D3 | YZ | Q2 | D3 | 2999 ~ | |
| | | SPHWWAHDNF25YZQ3D3 | | Q3 | | | |
| | 6500 | SPHWWAHDNF25YZP2D3 | YZ | P2 | D3 | 2974 ~ | |
| | | SPHWWAHDNF25YZP3D3 | | P3 | | | |
| | 90 | 2700 | SPHWWAHDNF27YZW1D3 | YZ | W1 | D3 | 2307 ~ |
| | | | SPHWWAHDNF27YZW2D3 | | W2 | | |
| | | 3000 | SPHWWAHDNF27YZV1D3 | YZ | V1 | D3 | 2426 ~ |
| | | | SPHWWAHDNF27YZV2D3 | | V2 | | |

| | | | | | | |
|----|------|--------------------|----|----|----|--------|
| | | SPHWAHDFNF27YZU1D3 | | U1 | | |
| | 3500 | SPHWAHDFNF27YZU2D3 | YZ | U2 | D3 | 2499 ~ |
| | | | | | | |
| | | SPHWAHDFNF27YZT1D3 | | T1 | | |
| | 4000 | SPHWAHDFNF27YZT2D3 | YZ | T2 | D3 | 2550 ~ |
| | | | | | | |
| | | SPHWAHDFNF27YZR2D3 | | R2 | | |
| 90 | 5000 | SPHWAHDFNF27YZR3D3 | YZ | R3 | D3 | 2572 ~ |

※ LCo26D(I_F = 720 mA, T_J = 85 °C)

| CRI(R _a) Min. | Nominal CCT(K) | Product Code | V _F Rank | Color Rank | Flux Rank | Flux Range (Φ _v , lm) | |
|------------------------------|-------------------|-------------------|------------------------|---------------|--------------|-------------------------------------|--------|
| 70 | 3000 | SPHWHHDNG23YZV2D3 | YZ | V2 | D3 | 4019 ~ | |
| | | SPHWHHDNG23YZV3D3 | | V3 | | | |
| | 4000 | SPHWHHDNG23YZT2D3 | YZ | T2 | D3 | 4093 ~ | |
| | | SPHWHHDNG23YZT3D3 | | T3 | | | |
| | 5000 | SPHWHHDNG23YZR2D3 | YZ | R2 | D3 | 4167 ~ | |
| | | SPHWHHDNG23YZR3D3 | | R3 | | | |
| 80 | 2700 | SPHWHHDNG25YZW1D3 | YZ | W1 | D3 | 3541 ~ | |
| | | SPHWHHDNG25YZW2D3 | | W2 | | | |
| | 3000 | SPHWHHDNG25YZV1D3 | YZ | V1 | D3 | 3721 ~ | |
| | | SPHWHHDNG25YZV2D3 | | V2 | | | |
| | 3500 | SPHWHHDNG25YZU1D3 | YZ | U1 | D3 | 3830 ~ | |
| | | SPHWHHDNG25YZU2D3 | | U2 | | | |
| | 4000 | SPHWHHDNG25YZT1D3 | YZ | T1 | D3 | 3907 ~ | |
| | | SPHWHHDNG25YZT2D3 | | T2 | | | |
| | 5000 | SPHWHHDNG25YZR2D3 | YZ | R2 | D3 | 3939 ~ | |
| | | SPHWHHDNG25YZR3D3 | | R3 | | | |
| | 5700 | SPHWHHDNG25YZQ2D3 | YZ | Q2 | D3 | 3939 ~ | |
| | | SPHWHHDNG25YZQ3D3 | | Q3 | | | |
| | 6500 | SPHWHHDNG25YZP2D3 | YZ | P2 | D3 | 3907 ~ | |
| | | SPHWHHDNG25YZP3D3 | | P3 | | | |
| | 90 | 2700 | SPHWHHDNG27YZW1D3 | YZ | W1 | D3 | 3030 ~ |
| | | | SPHWHHDNG27YZW2D3 | | W2 | | |
| | | 3000 | SPHWHHDNG27YZV1D3 | YZ | V1 | D3 | 3187 ~ |
| | | | SPHWHHDNG27YZV2D3 | | V2 | | |

| | | | | | | |
|----|------|-------------------|----|-------|----|--------|
| | | SPHWAHDNG27YZU1D3 | | U1 | | |
| | 3500 | | YZ | | D3 | 3282 ~ |
| | | SPHWAHDNG27YZU2D3 | | U2 | | |
| | | <hr/> | | | | |
| | | SPHWAHDNG27YZT1D3 | | T1 | | |
| 90 | 4000 | | YZ | | D3 | 3350 ~ |
| | | SPHWAHDNG27YZT2D3 | | T2 | | |
| | | <hr/> | | | | |
| | | SPHWAHDNG27YZR2D3 | | R2 | | |
| | 5000 | | YZ | | D3 | 3379 ~ |
| | | SPHWAHDNG27YZR3D3 | | R3 | | |

※ LCo33D(I_F = 900 mA, T_J = 85 °C)

| CRI(R _a) Min. | Nominal CCT(K) | Product Code | V _F Rank | Color Rank | Flux Rank | Flux Range (Φ _v , lm) | |
|------------------------------|-------------------|-------------------|------------------------|---------------|--------------|-------------------------------------|--------|
| 70 | 3000 | SPHWAHDNH23YZV2D3 | YZ | V2 | D3 | 4973 ~ | |
| | | SPHWAHDNH23YZV3D3 | | V3 | | | |
| | 4000 | SPHWAHDNH23YZT2D3 | YZ | T2 | D3 | 5065 ~ | |
| | | SPHWAHDNH23YZT3D3 | | T3 | | | |
| | 5000 | SPHWAHDNH23YZR2D3 | YZ | R2 | D3 | 5157 ~ | |
| | | SPHWAHDNH23YZR3D3 | | R3 | | | |
| 80 | 2700 | SPHWAHDNH25YZW1D3 | YZ | W1 | D3 | 4382 ~ | |
| | | SPHWAHDNH25YZW2D3 | | W2 | | | |
| | 3000 | SPHWAHDNH25YZV1D3 | YZ | V1 | D3 | 4605 ~ | |
| | | SPHWAHDNH25YZV2D3 | | V2 | | | |
| | 3500 | SPHWAHDNH25YZU1D3 | YZ | U1 | D3 | 4740 ~ | |
| | | SPHWAHDNH25YZU2D3 | | U2 | | | |
| | 4000 | SPHWAHDNH25YZT1D3 | YZ | T1 | D3 | 4834 ~ | |
| | | SPHWAHDNH25YZT2D3 | | T2 | | | |
| | 5000 | SPHWAHDNH25YZR2D3 | YZ | R2 | D3 | 4875 ~ | |
| | | SPHWAHDNH25YZR3D3 | | R3 | | | |
| | 5700 | SPHWAHDNH25YZQ2D3 | YZ | Q2 | D3 | 4875 ~ | |
| | | SPHWAHDNH25YZQ3D3 | | Q3 | | | |
| | 6500 | SPHWAHDNH25YZP2D3 | YZ | P2 | D3 | 4834 ~ | |
| | | SPHWAHDNH25YZP3D3 | | P3 | | | |
| | 90 | 2700 | SPHWAHDNH27YZW1D3 | YZ | W1 | D3 | 3750 ~ |
| | | | SPHWAHDNH27YZW2D3 | | W2 | | |
| | | 3000 | SPHWAHDNH27YZV1D3 | YZ | V1 | D3 | 3944 ~ |
| | | | SPHWAHDNH27YZV2D3 | | V2 | | |

| | | | | | | |
|----|------|-------------------|----|-------|----|--------|
| | | SPHWAHDNH27YZU1D3 | | U1 | | |
| | 3500 | | YZ | | D3 | 4062 ~ |
| | | SPHWAHDNH27YZU2D3 | | U2 | | |
| | | | | | | |
| | | SPHWAHDNH27YZT1D3 | | T1 | | |
| 90 | 4000 | | YZ | | D3 | 4146 ~ |
| | | SPHWAHDNH27YZT2D3 | | T2 | | |
| | | | | | | |
| | | SPHWAHDNH27YZR2D3 | | R2 | | |
| | 5000 | | YZ | | D3 | 4181 ~ |
| | | SPHWAHDNH27YZR3D3 | | R3 | | |

※ LCo₄oD(I_F = 1080 mA, T_J = 85 °C)

| CRI(R _a) Min. | Nominal CCT(K) | Product Code | V _F Rank | Color Rank | Flux Rank | Flux Range (Φ _v , lm) | |
|------------------------------|-------------------|-------------------|------------------------|---------------|--------------|-------------------------------------|--------|
| 70 | 3000 | SPHWAHDNK23YZV2D3 | YZ | V2 | D3 | 6118 ~ | |
| | | SPHWAHDNK23YZV3D3 | | V3 | | | |
| | 4000 | SPHWAHDNK23YZT2D3 | YZ | T2 | D3 | 6232 ~ | |
| | | SPHWAHDNK23YZT3D3 | | T3 | | | |
| | 5000 | SPHWAHDNK23YZR2D3 | YZ | R2 | D3 | 6345 ~ | |
| | | SPHWAHDNK23YZR3D3 | | R3 | | | |
| 80 | 2700 | SPHWAHDNK25YZW1D3 | YZ | W1 | D3 | 5391 ~ | |
| | | SPHWAHDNK25YZW2D3 | | W2 | | | |
| | 3000 | SPHWAHDNK25YZV1D3 | YZ | V1 | D3 | 5665 ~ | |
| | | SPHWAHDNK25YZV2D3 | | V2 | | | |
| | 3500 | SPHWAHDNK25YZU1D3 | YZ | U1 | D3 | 5831 ~ | |
| | | SPHWAHDNK25YZU2D3 | | U2 | | | |
| | 4000 | SPHWAHDNK25YZT1D3 | YZ | T1 | D3 | 5948 ~ | |
| | | SPHWAHDNK25YZT2D3 | | T2 | | | |
| | 5000 | SPHWAHDNK25YZR2D3 | YZ | R2 | D3 | 5998 ~ | |
| | | SPHWAHDNK25YZR3D3 | | R3 | | | |
| | 5700 | SPHWAHDNK25YZQ2D3 | YZ | Q2 | D3 | 5998 ~ | |
| | | SPHWAHDNK25YZQ3D3 | | Q3 | | | |
| | 6500 | SPHWAHDNK25YZP2D3 | YZ | P2 | D3 | 5948 ~ | |
| | | SPHWAHDNK25YZP3D3 | | P3 | | | |
| | 90 | 2700 | SPHWAHDNK27YZW1D3 | YZ | W1 | D3 | 4614 ~ |
| | | | SPHWAHDNK27YZW2D3 | | W2 | | |
| | | 3000 | SPHWAHDNK27YZV1D3 | YZ | V1 | D3 | 4853 ~ |
| | | | SPHWAHDNK27YZV2D3 | | V2 | | |

| | | | | | | |
|----|------|-------------------|----|-------|----|--------|
| | | SPHWAHDNK27YZU1D3 | | U1 | | |
| | 3500 | | YZ | | D3 | 4997 ~ |
| | | SPHWAHDNK27YZU2D3 | | U2 | | |
| | | <hr/> | | | | |
| | | SPHWAHDNK27YZT1D3 | | T1 | | |
| 90 | 4000 | | YZ | | D3 | 5100 ~ |
| | | SPHWAHDNK27YZT2D3 | | T2 | | |
| | | <hr/> | | | | |
| | | SPHWAHDNK27YZR2D3 | | R2 | | |
| | 5000 | | YZ | | D3 | 5144 ~ |
| | | SPHWAHDNK27YZR3D3 | | R3 | | |

※ LCo6oD(I_F = 1080 mA, T_J = 85 °C)

| CRI(R _a) Min. | Nominal CCT(K) | Product Code | V _F Rank | Chrom. Bin | Flux Rank | Flux Range (Φ _v , lm) | |
|------------------------------|-------------------|-------------------|------------------------|---------------|--------------|-------------------------------------|--------|
| 70 | 3000 | SPHWAHDNL231ZV2D3 | 1Z | V2 | D3 | 9042 ~ | |
| | | SPHWAHDNL231ZV3D3 | | V3 | | | |
| | 4000 | SPHWAHDNL231ZT2D3 | 1Z | T2 | D3 | 9209 ~ | |
| | | SPHWAHDNL231ZT3D3 | | T3 | | | |
| | 5000 | SPHWAHDNL231ZR2D3 | 1Z | R2 | D3 | 9377 ~ | |
| | | SPHWAHDNL231ZR3D3 | | R3 | | | |
| 80 | 2700 | SPHWAHDNL251ZW1D3 | 1Z | W1 | D3 | 7967 ~ | |
| | | SPHWAHDNL251ZW2D3 | | W2 | | | |
| | 3000 | SPHWAHDNL251ZV1D3 | 1Z | V1 | D3 | 8372 ~ | |
| | | SPHWAHDNL251ZV2D3 | | V2 | | | |
| | 3500 | SPHWAHDNL251ZU1D3 | 1Z | U1 | D3 | 8617 ~ | |
| | | SPHWAHDNL251ZU2D3 | | U2 | | | |
| | 4000 | SPHWAHDNL251ZT1D3 | 1Z | T1 | D3 | 8790 ~ | |
| | | SPHWAHDNL251ZT2D3 | | T2 | | | |
| | 5000 | SPHWAHDNL251ZR2D3 | 1Z | R2 | D3 | 8864 ~ | |
| | | SPHWAHDNL251ZR3D3 | | R3 | | | |
| | 5700 | SPHWAHDNL251ZQ2D3 | 1Z | Q2 | D3 | 8864 ~ | |
| | | SPHWAHDNL251ZQ3D3 | | Q3 | | | |
| | 6500 | SPHWAHDNL251ZP2D3 | 1Z | P2 | D3 | 8790 ~ | |
| | | SPHWAHDNL251ZP3D3 | | P3 | | | |
| | 90 | 2700 | SPHWAHDNL271ZW1D3 | 1Z | W1 | D3 | 6818 ~ |
| | | | SPHWAHDNL271ZW2D3 | | W2 | | |
| | | 3000 | SPHWAHDNL271ZV1D3 | 1Z | V1 | D3 | 7172 ~ |
| | | | SPHWAHDNL271ZV2D3 | | V2 | | |

| | | | | | | |
|----|------|-------------------|----|-------|----|--------|
| | | SPHWAHDNL271ZU1D3 | | U1 | | |
| | 3500 | | 1Z | | D3 | 7385 ~ |
| | | SPHWAHDNL271ZU2D3 | | U2 | | |
| | | <hr/> | | | | |
| | | SPHWAHDNL271ZT1D3 | | T1 | | |
| 90 | 4000 | | 1Z | | D3 | 7537 ~ |
| | | SPHWAHDNL271ZT2D3 | | U2 | | |
| | | <hr/> | | | | |
| | | SPHWAHDNL271ZR2D3 | | R2 | | |
| | 5000 | | 1Z | | D3 | 7602 ~ |
| | | SPHWAHDNL271ZR3D3 | | R3 | | |

※ LCo8oD(I_F = 1620 mA, T_J = 85 °C)

| CRI(R _a) Min. | Nominal CCT(K) | Product Code | V _F Rank | Chrom. Bin | Flux Rank | Flux Range (Φ _v , lm) | |
|------------------------------|-------------------|--------------------|------------------------|---------------|--------------|-------------------------------------|---------|
| 70 | 3000 | SPHWWAHDNM231ZV2D3 | 1Z | V2 | D3 | 13409 ~ | |
| | | SPHWWAHDNM231ZV3D3 | | V3 | | | |
| | 4000 | SPHWWAHDNM231ZT2D3 | 1Z | T2 | D3 | 13657 ~ | |
| | | SPHWWAHDNM231ZT3D3 | | T3 | | | |
| | 5000 | SPHWWAHDNM231ZR2D3 | 1Z | R2 | D3 | 13906 ~ | |
| | | SPHWWAHDNM231ZR3D3 | | R3 | | | |
| 80 | 2700 | SPHWWAHDNM251ZW1D3 | 1Z | W1 | D3 | 11815 ~ | |
| | | SPHWWAHDNM251ZW2D3 | | W2 | | | |
| | 3000 | SPHWWAHDNM251ZV1D3 | 1Z | V1 | D3 | 12416 ~ | |
| | | SPHWWAHDNM251ZV2D3 | | V2 | | | |
| | 3500 | SPHWWAHDNM251ZU1D3 | 1Z | U1 | D3 | 12779 ~ | |
| | | SPHWWAHDNM251ZU2D3 | | U2 | | | |
| | 4000 | SPHWWAHDNM251ZT1D3 | 1Z | T1 | D3 | 13035 ~ | |
| | | SPHWWAHDNM251ZT2D3 | | T2 | | | |
| | 5000 | SPHWWAHDNM251ZR2D3 | 1Z | R2 | D3 | 13144 ~ | |
| | | SPHWWAHDNM251ZR3D3 | | R3 | | | |
| | 5700 | SPHWWAHDNM251ZQ2D3 | 1Z | Q2 | D3 | 13144 ~ | |
| | | SPHWWAHDNM251ZQ3D3 | | Q3 | | | |
| | 6500 | SPHWWAHDNM251ZP2D3 | 1Z | P2 | D3 | 13035 ~ | |
| | | SPHWWAHDNM251ZP3D3 | | P3 | | | |
| | 90 | 2700 | SPHWWAHDNM271ZW1D3 | 1Z | W1 | D3 | 10111 ~ |
| | | | SPHWWAHDNM271ZW2D3 | | W2 | | |
| | | 3000 | SPHWWAHDNM271ZV1D3 | 1Z | V1 | D3 | 10635 ~ |
| | | | SPHWWAHDNM271ZV2D3 | | V2 | | |

| | | | | | | |
|----|------|--------------------|----|----|----|---------|
| | 3500 | SPHWWAHDNM271ZU1D3 | 1Z | U1 | D3 | 10952 ~ |
| | | SPHWWAHDNM271ZU2D3 | | U2 | | |
| 90 | 4000 | SPHWWAHDNM271ZT1D3 | 1Z | T1 | D3 | 11178 ~ |
| | | SPHWWAHDNM271ZT2D3 | | T2 | | |
| | 5000 | SPHWWAHDNM271ZR2D3 | 1Z | R2 | D3 | 11273 ~ |
| | | SPHWWAHDNM271ZR3D3 | | R3 | | |

b) Chromaticity Region & Coordinates (I_F = Sorting Current, T_J = 85 °C)

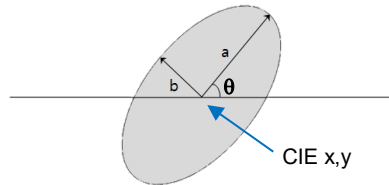
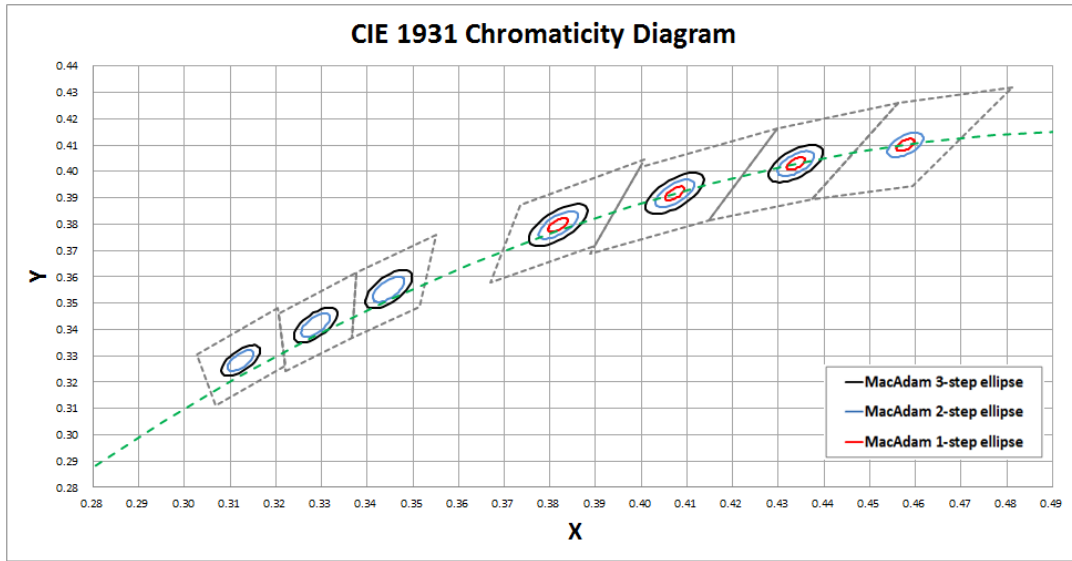

| MacAdam Ellipse (W1, W2) | | | | | |
|--------------------------|--------|--------|-------|--------|--------|
| Step | CIE x | CIE y | θ | a | b |
| 1-step | 0.4578 | 0.4101 | 53.70 | 0.0027 | 0.0014 |
| 2-step | 0.4578 | 0.4101 | 53.7 | 0.0054 | 0.0028 |

| MacAdam Ellipse (V1, V2, V3) | | | | | |
|------------------------------|--------|--------|-------|--------|--------|
| Step | CIE x | CIE y | θ | a | b |
| 1-step | 0.4338 | 0.4030 | 53.22 | 0.0028 | 0.0014 |
| 2-step | 0.4338 | 0.4030 | 53.22 | 0.0056 | 0.0027 |
| 3-step | 0.4338 | 0.4030 | 53.22 | 0.0083 | 0.0041 |

| MacAdam Ellipse (U1, U2, U3) | | | | | |
|------------------------------|--------|--------|-------|--------|--------|
| Step | CIE x | CIE y | θ | a | b |
| 1-step | 0.4073 | 0.3917 | 54.00 | 0.0031 | 0.0014 |
| 2-step | 0.4073 | 0.3917 | 54.00 | 0.0062 | 0.0028 |
| 3-step | 0.4073 | 0.3917 | 54.00 | 0.0093 | 0.0041 |

| MacAdam Ellipse (T1, T2, T3) | | | | | |
|------------------------------|--------|--------|-------|--------|--------|
| Step | CIE x | CIE y | θ | a | b |
| 1-step | 0.3818 | 0.3797 | 53.72 | 0.0031 | 0.0013 |
| 2-step | 0.3818 | 0.3797 | 53.72 | 0.0063 | 0.0027 |
| 3-step | 0.3818 | 0.3797 | 53.72 | 0.0094 | 0.0040 |

| MacAdam Ellipse (R2, R3) | | | | | |
|--------------------------|--------|--------|-------|--------|--------|
| Step | CIE x | CIE y | θ | a | b |
| 2-step | 0.3447 | 0.3553 | 59.62 | 0.0055 | 0.0024 |
| 3-step | 0.3447 | 0.3553 | 59.62 | 0.0082 | 0.0035 |

| MacAdam Ellipse (Q2, Q3) | | | | | |
|--------------------------|--------|--------|-------|--------|--------|
| Step | CIE x | CIE y | θ | a | b |
| 2-step | 0.3287 | 0.3417 | 59.10 | 0.0050 | 0.0021 |
| 3-step | 0.3287 | 0.3417 | 59.10 | 0.0075 | 0.0032 |

| MacAdam Ellipse (P2, P3) | | | | | |
|--------------------------|--------|--------|-------|--------|--------|
| Step | CIE x | CIE y | θ | a | b |
| 2-step | 0.3123 | 0.3282 | 58.57 | 0.0045 | 0.0019 |
| 3-step | 0.3123 | 0.3282 | 58.57 | 0.0067 | 0.0029 |

Note:

Samsung maintains measurement tolerance of: C_x, C_y = ±0.005

3. Typical Characteristics Graphs

a) Spectrum Distribution (I_f = Sorting Current, T_j = 85 °C)

CRI Ra 80+



CRI Ra 90+



CRI Ra 70+



b) Forward Current Characteristics ($T_J = 85\text{ }^\circ\text{C}$)

1) LC003D



2) LC006D

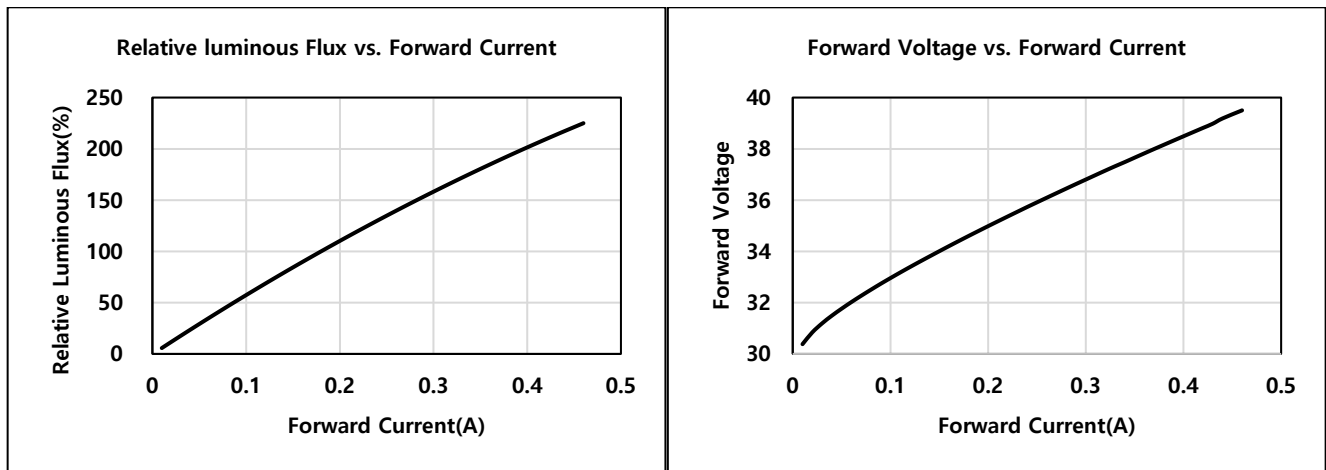

3) LC009D



4) LC013D

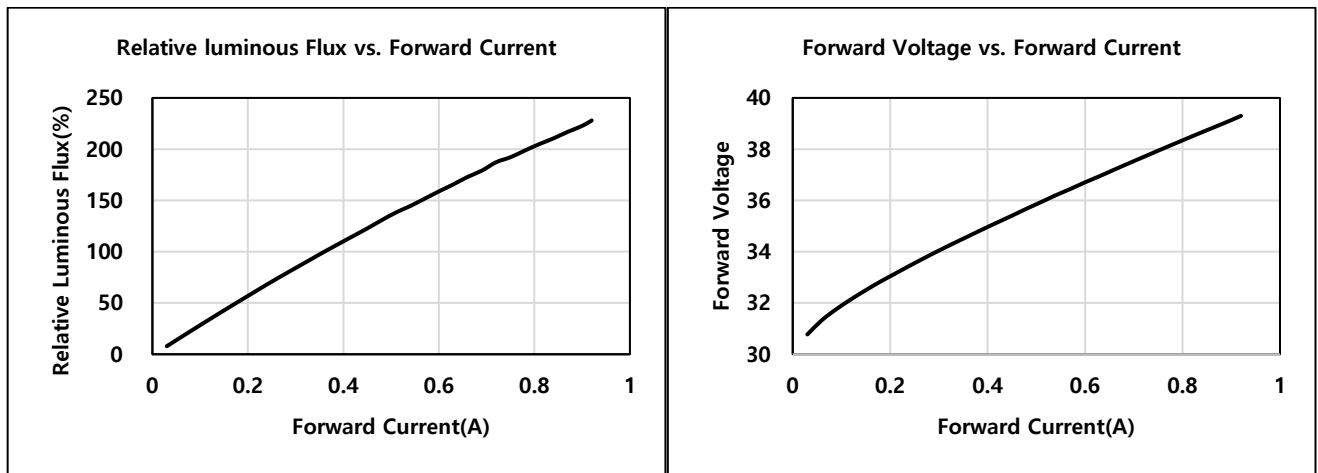

5) LC016D

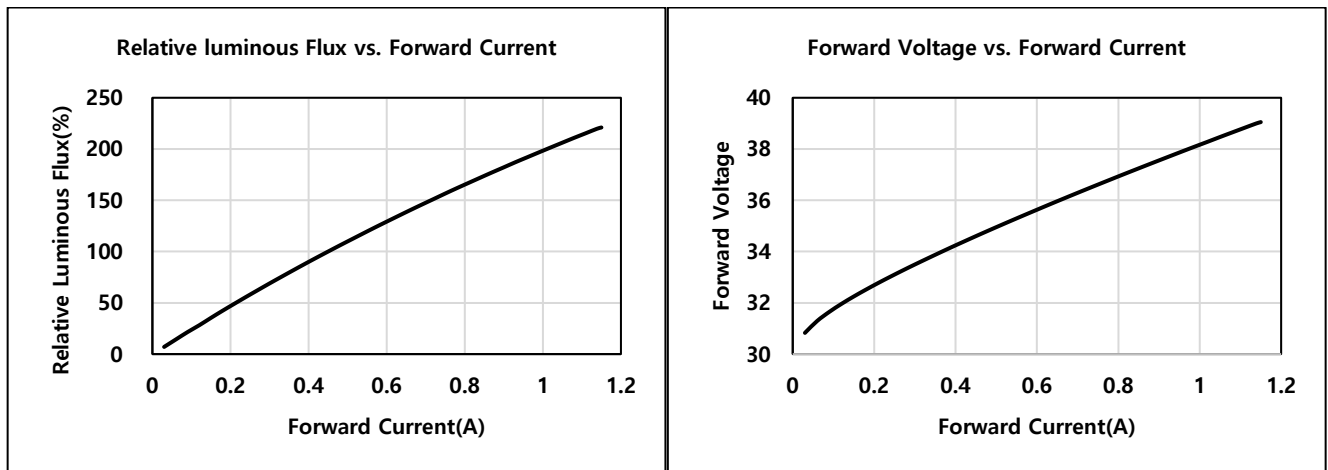

6) LC019D

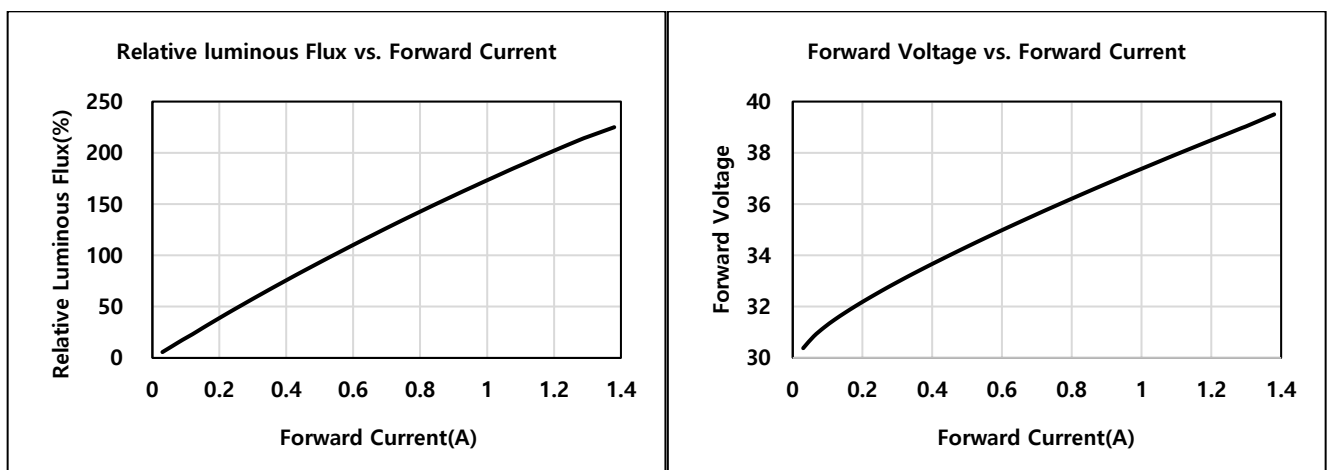

7) LC026D



8) LC033D



9) LC040D



10) LC060D

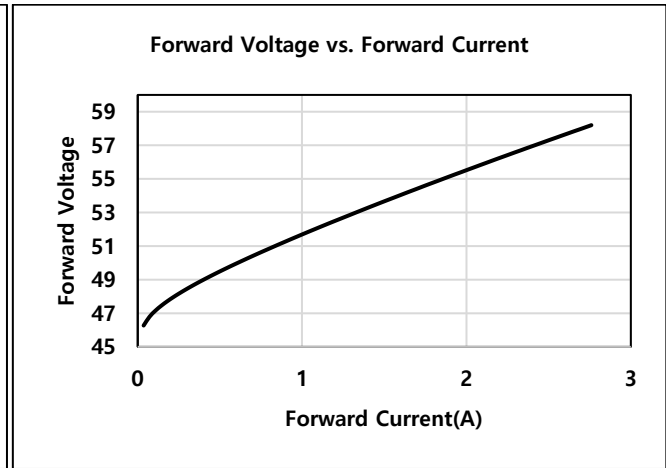

11) LC080D

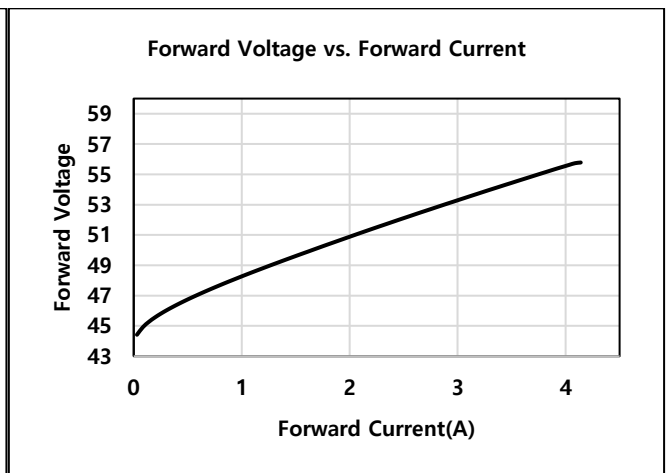

c) Temperature Characteristics (I_F = Sorting Current)



d) Color Shift Characteristics ($T_J = 85^\circ\text{C}$, I_F = Sorting Current, CRI = 80+)



e) Beam Angle Characteristics (I_F = Sorting Current, $T_J = 85^\circ\text{C}$)



f) Derating Characteristics

1) LC003D



2) LC006D



3) LC009D4) LC0013D



5) LC016D



6) LC0019D



7) LC026D



8) LC0033D



9) LC040D



10) LC060D



11) LC080D



4. Outline Drawing & Dimension

※ Model : LC003D, LC006D, LC009D, LC013D



- 1. Unit: mm
- 2. Tolerance: ± 0.3 mm

| Item | Dimension | Tolerance | Unit |
|--------------|------------------------|-----------|------|
| Length | 13.5 | ±0.15 | mm |
| Width | 13.5 | ±0.15 | mm |
| Height | Dam | ±0.20 | mm |
| | Substrate | ±0.10 | mm |
| LES Diameter | Light Emitting Surface | ±0.30 | mm |

Note: Denoted product information above is only an example
(LC013D38030 :LC013D, Gen3, Ra80, 3000K)

※ Model : LC016D, LC019D, LC026D, LC033D

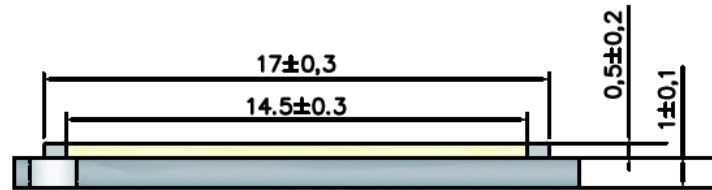
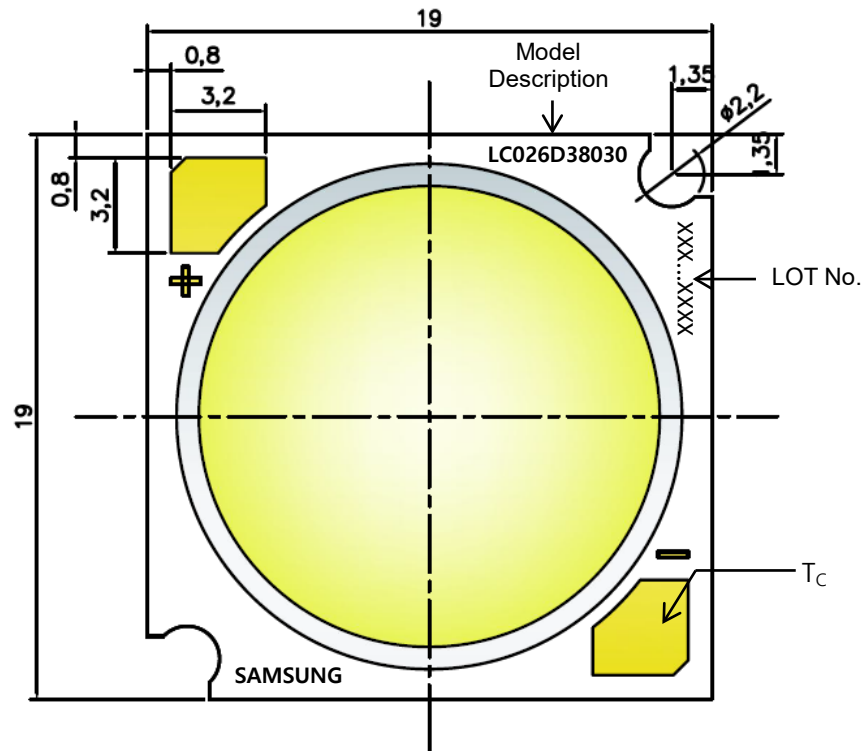

1. Unit: mm
2. Tolerance: ± 0.3 mm

| Item | Dimension | Tolerance | Unit |
|--------------|------------------------|------------|------|
| Length | 19.0 | ± 0.15 | mm |
| Width | 19.0 | ± 0.15 | mm |
| Height | Dam | ± 0.20 | mm |
| | Substrate | ± 0.10 | mm |
| LES Diameter | Light Emitting Surface | ± 0.30 | mm |

Note: Denoted product information above is only an example
 (LC026D38030 : LC026D, Gen3, CRI80+, 3000K)

※ Model : LC040D, LC060D, LC080D



- 1. Unit: mm
- 2. Tolerance: ± 0.3 mm

| Item | Dimension | Tolerance | Unit |
|--------------|------------------------|-----------|------|
| Length | 28.0 | ±0.15 | mm |
| Width | 28.0 | ±0.15 | mm |
| Height | Dam | ±0.20 | mm |
| | Substrate | ±0.10 | mm |
| LES Diameter | Light Emitting Surface | ±0.30 | mm |

Note: Denoted product information above is only an example
 (LC040D38030 : LC040D, Gen3, CRI80+, 3000K)

5. Reliability Test Items & Conditions

a) Test Items

| Test Item | Test Condition | Test Hour / Cycle |
|--|---|-------------------|
| Wet High Temperature Operating Life Test (WHTOL) | 60 °C, 90 % RH,, DC Derating, I _F | 1000 h |
| High Temperature Operating Life Test (HTOL) | 85 °C, DC Derating, I _F | 1000 h |
| Low Temperature Operating Life Test (LTOL) | -40 °C, DC,DeratingI _F | 1000 h |
| High Temperature Storage | 110 °C | 1000 h |
| Low Temperature Storage | -40 °C | 1000 h |
| Wet High Temperature Storage Test | 85°C, 85% RH | 1000h |
| Temperature Cycling | -45 °C / 15min ~ 125 °C / 15min Temperature change within 5min | 500 cycle |
| Powered Temperature Cycle (PTC) | -40 °C/ 85 °C each 10 min, 20 min transfer power on/off each 5 min, DC Derating, I _F = max | 100 cycles |
| ESD (HBM) | R ₁ : 10 MΩ R ₂ : 1.5 kΩ C: 100 pF V: ±2 kV | 5 times |
| Vibrations Variable Frequency | 20~ 80 Hz (displacement: 0.06 inch, max. 20 g) 80 ~ 2 kHz (max. 20 g) min. frequency ↔max. frequency 4 min transfer | 4 times |
| Mechanical Shock Test | 1500g, 0.5 ms each of the 6 surfaces (3 axis x 2 sides) | 5 times |
| Hydrogen Sulphide(H ₂ S) | 25 °C 75%R.H. H ₂ S concentration 15ppm | 504h |

b) Criteria for Judging the Damage

| Item | Symbol | Test Condition (T _c = 25 °C) | Limit | |
|-----------------|----------------|--|--------------|--------------|
| | | | Min. | Max. |
| Forward Voltage | V _F | I _F = Sorting Current | L.S.L. * 0.9 | U.S.L. * 1.1 |
| Luminous Flux | Φ _v | I _F = Sorting Current | L.S.L * 0.7 | U.S.L * 1.3 |

6. Label Structure

a) Label Structure



Note: Denoted bincode and product code above is only an example (see description on page 5)

Bin Code:

ⒶⒷ: Forward Voltage bin (refer to page 9)

ⒸⒹ: Chromaticity bin (refer to page 21)

ⒺⒻ: Luminous Flux bin (refer to page 5-8)

b) Lot Number

The lot number is composed of the following characters:



① ③④⑤⑥⑦⑧⑨ / 1ⒶⒷⒸ / xxxx pcs

① : Production site (S: Giheung, Korea, G: Tianjin, China)

② : 4(LED)

③ : Product state (A: Normal, B: Bulk, C: First Production, R: Reproduction, S: Sample)

④ : Year (Z: 2015, A: 2016, B: 2017...)

⑤ : Month (1~9, A, B, C)

⑥⑦⑧⑨ : Day (1~9, A, B~V)

ⒶⒷⒸ : Product serial number (001 ~ 999)

7. Packing Structure

※ Model : L003D, LC006D, LC009D, LC013D

| Packing material | Max. quantity in pcs of COB | Dimension(mm) | | | |
|--------------------|-----------------------------|---------------|-------|--------|-----------|
| | | Length | Width | Height | Tolerance |
| Tray | 50 | 200 | 200 | 8 | 1 |
| Anti-Static Bag | 250 (5 trays) | 320 | 270 | - | +/- 0.5 |
| Outer Box (Small) | 500 (2 bags) | 225 | 225 | 65 | 5 |
| Outer Box (Middle) | 1000 (4 bags) | 225 | 225 | 130 | 5 |

a) Packing Structure



b) Tray



※ Model : LC016D, LC019D, LC026D, LC033D

| Packing material | Max. quantity in pcs of COB | Dimension(mm) | | | |
|--------------------|-----------------------------|---------------|-------|--------|-----------|
| | | Length | Width | Height | Tolerance |
| Tray | 25 | 200 | 200 | 8 | 1 |
| Anti-Static Bag | 125 (5 trays) | 320 | 270 | - | +/- 0.5 |
| Outer Box (Small) | 250 (2 bags) | 225 | 225 | 65 | 5 |
| Outer Box (Middle) | 500 (4 bags) | 225 | 225 | 130 | 5 |

a) Packing Structure

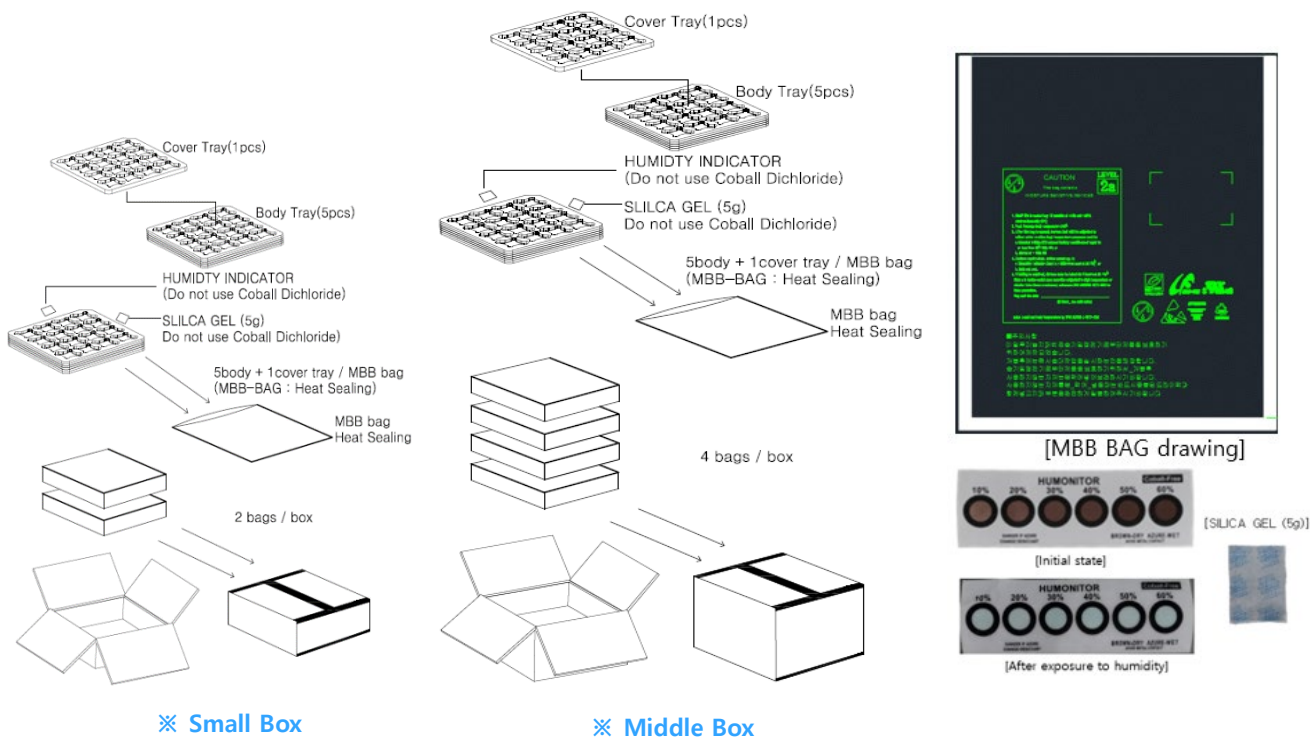

※ Small Box

※ Middle Box

b) Tray

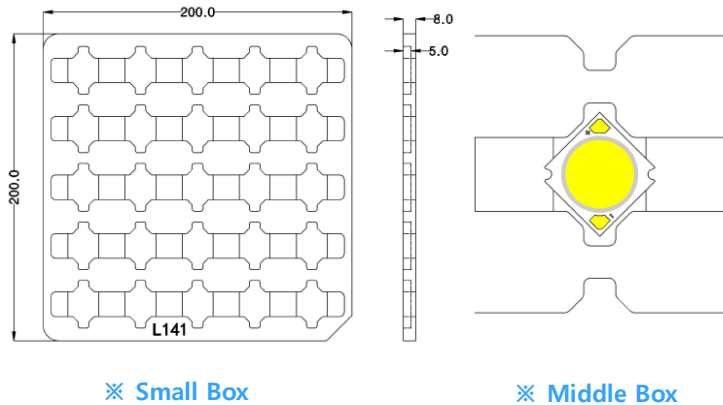

※ Small Box

※ Middle Box

※ Model : LC040D, LC060D, LC080D

| Packing material | Max. quantity in pcs of COB | Dimension(mm) | | | |
|---------------------------|-----------------------------|---------------|-------|--------|-----------|
| | | Length | Width | Height | Tolerance |
| Tray | 16 | 200 | 200 | 8 | 1 |
| Anti-Static Bag | 80 (5 trays) | 320 | 270 | - | +/- 0.5 |
| Outer Box (Small) | 160 (2 bags) | 225 | 225 | 65 | 5 |
| Outer Box (Middle) | 320 (4 bags) | 225 | 225 | 130 | 5 |

a) Packing Structure



※ Small Box

※ Middle Box

b) Tray



※ Small Box

※ Middle Box

8. Precautions in Handling & Use

- 1) This device should not be used in any type of fluid such as water, oil, organic solvent, etc. Some solvent-based cleaning agent may damage the silicone resins used in the device.
- 2) LEDs must be stored in a clean environment. Shelf life of sealed bags is 12 months at temperature 0~40 °C, 0~90 % RH.
- 3) After storage bag is opened, device subjected to soldering (wiring), or other high temperature processes must be:
 - a. Mounted within 672 hours (28 days) at an assembly line with a condition of no more than 30 °C / 60 % RH, or
 - b. Stored at <10 % RH
- 4) Repack unused products with anti-moisture packing, fold to close any opening and then store in a dry place.
- 5) Devices require baking before mounting, if humidity card reading is >60 % at 23 ± 5 °C.
- 6) Devices must be baked for 1 hour at 60 ± 5 °C, if baking is required.
- 7) The LEDs are sensitive to the static electricity and surge current. It is recommended to use a wrist band or anti-electrostatic glove when handling the LEDs. If voltage exceeding the absolute maximum rating is applied to LEDs, it may cause damage or even destruction to LED devices. Damaged LEDs may show some unusual characteristics such as increase in leakage current, lowered turn-on voltage, or abnormal lighting of LEDs at low current.
- 8) The thermal management is one of the most critical factors for the LED lighting system. Especially the LED junction temperature should not exceed the absolute maximum rating while operation of LED lighting system.
For more information, please refer to Application Note 'Mechanical & Thermal Guide for COB'.
- 9) In case of driving LEDs around the minimum current level (I_{f_min}), chips might exhibit different brightness due to the variation in I-V characteristics of each one. This is normal and does not adversely affect the performance of product.
- 10) VOCs (Volatile Organic Compounds) can be generated from adhesives, flux, hardener or organic additives used in luminaires (fixtures). Transparent LED silicone encapsulant is permeable to those chemicals and they may lead to a discoloration of encapsulant when they exposed to heat or light. This phenomenon can cause a significant loss of light emitted (output) from the luminaires. In order to prevent these problems, we recommend users to know the physical properties of materials used in luminaires and they must be carefully selected.
- 11) The resin area is very sensitive, please do not handle, press, touch, rub, clean, or pick by with tweezers on it. Instead, please pick at the handling area as indicated below.



Legal and additional information.

[About Samsung Electronics Co., Ltd.](#)

Samsung Electronics Co., Ltd. inspires the world and shapes the future with transformative ideas and technologies, redefining the worlds of TVs, smartphones, wearable devices, tablets, cameras, digital appliances, printers, medical equipment, network systems and semiconductors.

We are also leading in the Internet of Things space through, among others, our Digital Health and Smart Home initiatives. We employ 307,000 people across 84 countries. To discover more, please visit our official website at www.samsung.com and our official blog at global.samsungtomorrow.com.

Copyright © 2015 Samsung Electronics Co., Ltd. All rights reserved.

Samsung is a registered trademark of Samsung Electronics Co., Ltd.

Specifications and designs are subject to change without notice. Non-metric weights and measurements are approximate. All data were deemed correct at time of creation. Samsung is not liable for errors or omissions. All brand, product, service names and logos are trademarks and/or registered trademarks of their respective owners and are hereby recognized and acknowledged.

Samsung Electronics Co., Ltd.

95, Samsung 2-ro

Giheung-gu

Yongin-si, Gyeonggi-do, 446-711

KOREA

www.samsungled.com

SAMSUNG

Looking for pricing, stock, or lifecycle information?

Click below to explore more details on WIN SOURCE:

- ⊖ [View SPHWHADNB25YZT3D3 on WIN SOURCE](#)
- ⊖ [Samsung Information](#)

Optimize Your Supply Chain with WIN SOURCE Solutions

- ✓ Global Sourcing Solution
- ✓ Obsolete Management
- ✓ Cost Control Management
- ✓ Shortage Management
- ✓ Alternative Solution
- ✓ Excess Inventory Management