



**THE DATASHEET OF
SI-B8U101250WW**



SPECIFICATION



Tile Type LED Module			
Model Name	Finger-SQ64B, Finger-RT64B		
Type	259 x 250 [mm], 700mA (12V) 230 x 273 [mm], 700mA (12V)		
Parts No.		Square type (Finger-SQ64B)	Rectangular type (Finger-RT64B)
	3000K	SI-B8V101250WW	SI-B8V101280WW
	3500K	SI-B8U101250WW	SI-B8U101280WW
	4000K	SI-B8T101250WW	SI-B8T101280WW
	5000K	SI-B8R101250WW	SI-B8R101280WW
	6500K	SI-B8P101250WW	SI-B8P101280WW

SAMSUNG ELECTRONICS CO.,LTD.
SAN #24 NONGSEO-DONG, GIHEUNG-GU,
YONGIN-SI, GYEONGGI-DO, 446-711, KOREA



LED Module

Rev. No	Page
1.2	2 / 15

Revision History

Rev.No	Date	Page	Revision	Remark
1.0	September 2013	-	The specification is established. Total 14 pages	-
1.1	January 2014	5	The specification is revised	-
1.2	March 2014	6	The error of a figure is corrected.	-
		13	Added certification.	-

Contents

1	Products and Applications	4
2	Basic Specification	4
3	Structure and Assembly	7
4	Approbation	13
5	Packing	13
6	Precautions In Handling	14



LED Module

Rev. No

Page

1.2

4 / 15

1. Products and Application

This specification defines general specification and performance for Flat panel LED module. Samsung Finger-SQ64B, Finger-RT64B Modules maintains a high degree of light uniformity from the optimized arrangement of LEDs and it's better solution to replace conventional fluorescent tubes as T5, T8 and so on. Due to transferring LED, new luminaire transferred to LED can take more energy saving and longer life-time.

In special, Samsung has competitiveness in middle-power solutions. This module uses LM561B (5630G2) that is one of the best class of MPL. Middle power solutions provide more homogeneous and higher efficient lights.

2. Basic Specification

No.	Item	Specifications	Unit	Remark
2-1	Dimension	259.0(L) × 250(W) × 6.7(h) mm 230.0(L) × 273(W) × 6.7(h) mm	mm	Tolerance:±0.5mm
2-2	Weight	88	g	Tolerance:±0.9g
2-3	Rated lifetime	50,000 Hr	hour	L70B50 @Tc = 65℃
2-4	Ingress Protection	N/A	-	-

No.	Item	Specifications					Unit	Remark
		Sym.	Model	Min.	Typ.	Max.		
2-5	Luminous flux	Φ_v	3000K	1080	1210	1340	lm	@700mA, Tp = 35°C
			3500K	1100	1230	1360		
			4000K	1180	1310	1380		
			5000K	1180	1310	1450		
			6500K	1140	1270	1410		
2-6	Efficiency	LPW	3000K	-	149	-	lm/W	@700mA, Tp = 35°C
			3500K	-	152	-		
			4000K	-	162	-		
			5000K	-	162	-		
			6500K	-	157	-		
2-7	Color consistency		-	-	3	-	step	MacAdam @Initial time
2-8	Color Rendering Index	CRI	-	80	83	-	Ra	-
2-9	Operating Current	Iop	-	-	700	1600	mA	-
2-10	Operating Voltage	Vdc	-	10.5	11.5	12.5	V	@700mA, Tp = 35°C
2-11	Power Consumption	W	-	-	8.1	-		

※ Measurement tolerance of luminous flux becomes $\pm 7\%$ in typical value and the measurement tolerance of the color coordinates are ± 0.005 .

[2-12] Color Coordinates



@700mA, T_p = 35 °C

※ Measurement Tolerance : V_f : ±0.3 V, I_v : ±7 %, x,y : ±0.005

3. Structure and Assembly

3-1. Appearance

① Top View



< Finger-SQ64B >

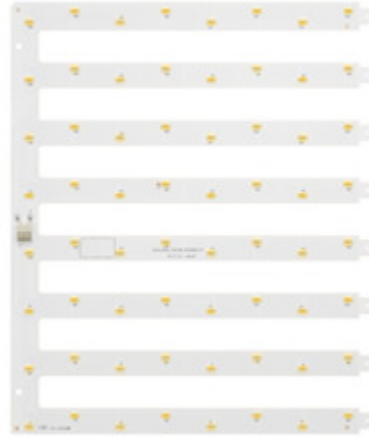

< Finger-RT64B >

3-2. Dimension

① Top View

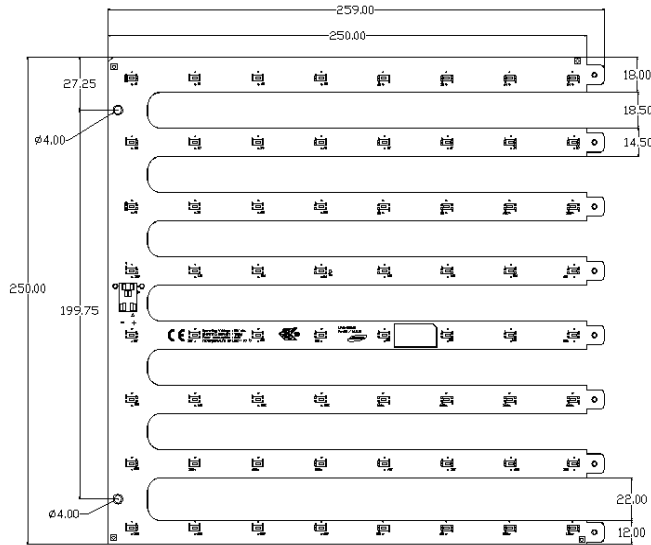

<Finger-SQ64B>

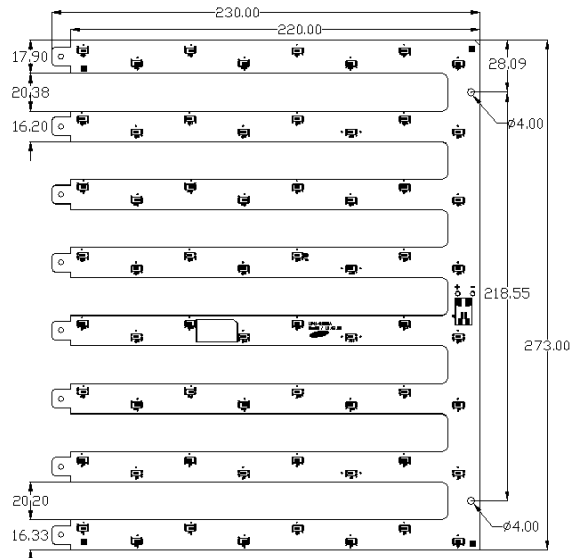

<Finger-SQ64B>

② Side View

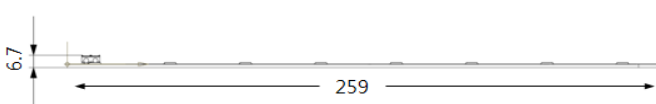

Square type <Finger-SQ64B>

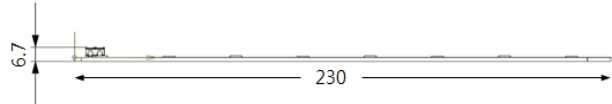

Rectangular type <Finger-RT64B>

Item		Specifications		Remark
		Finger-SQ64B	Finger-RT64B	
L	Length of PCB	257.0 ± 0.5 mm	230.0 ± 0.5 mm	-
W	Width of PCB	250.0 ± 0.5 mm	273.0 ± 0.5 mm	-
H1	Thickness of PCB	1.6 ± 0.1 mm	1.6 ± 0.1 mm	-
H2	Height of PCBA	6.7 ± 0.2 mm	6.7 ± 0.2 mm	-

3-3. Assembly

- ① 2x2 (600x600mm) by Finger-SQ64B x 4 pcs with 2-ch driver

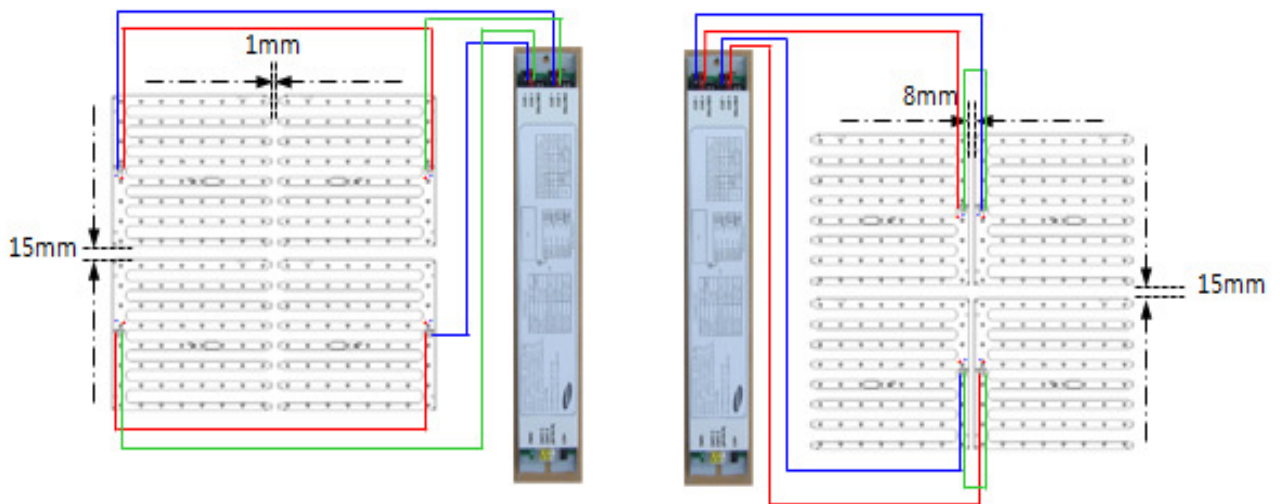

- ② 1x4 (300x1200mm) by Finger-RT64B x 4 pcs with 2-ch driver

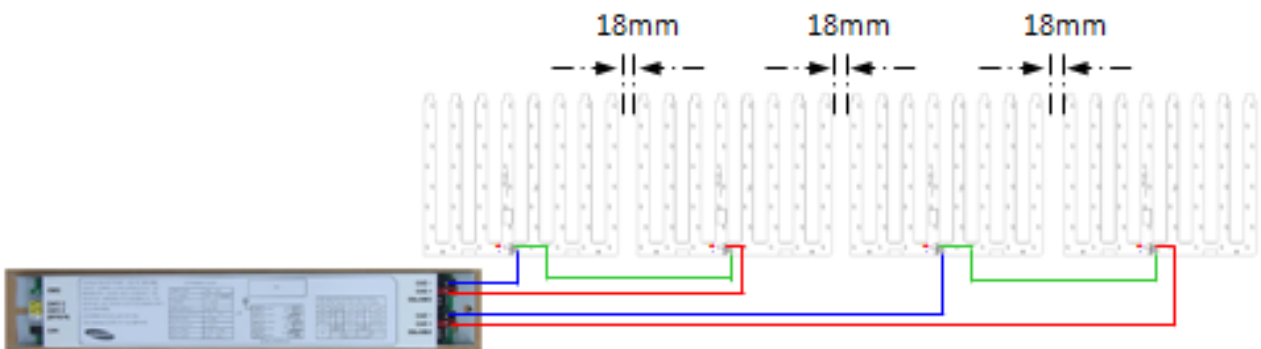

③ Connector : Terminal strip type

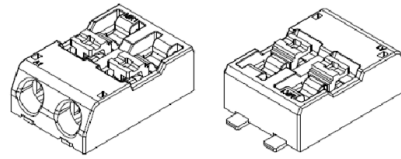

AWG 24-18

(1) Insert solid conductors via push-in termination.

(2) Insert or remove fine-standard conductors by lightly pressing on push-button.

④ Wire Harness

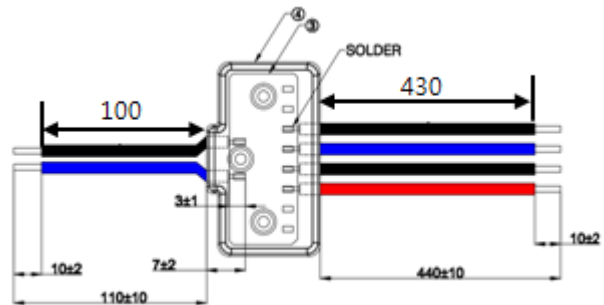
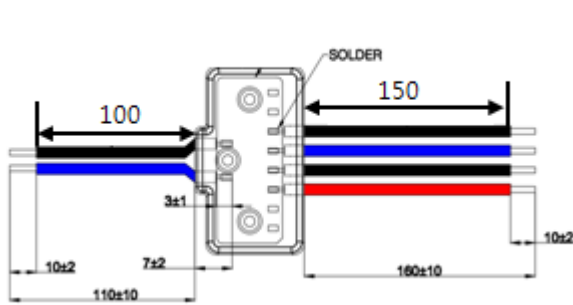

<Harness Cable 100/150 , separate order code>

<Harness Cable 100/430 , separate order code>

3-4. Structure

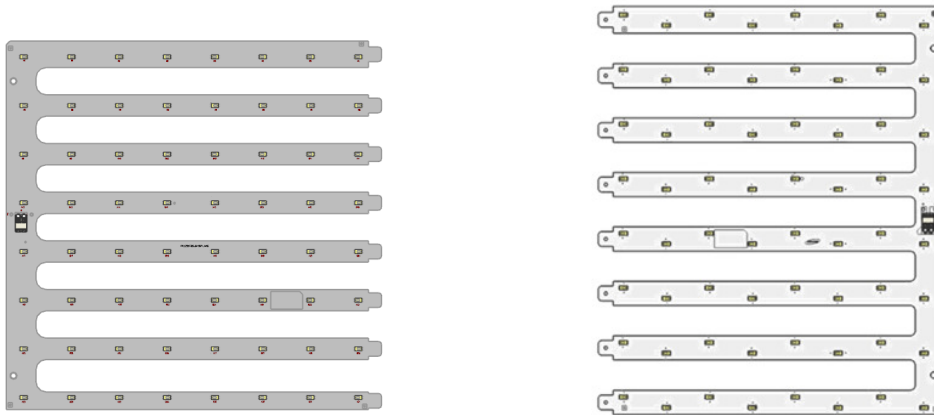

No.		Item	Specifications
Module Assembly	3-1	LED	LM561B Middle Power LED 64 ea
	3-2	PCB	Material : Copper, Solder mask and Epoxy
	3-3	Connector	Reworkable Poke-in connector

3-5. Light Distribution

(1) Polar Intensity Diagram : Beam Angle $115 \pm 5\%$ [°]

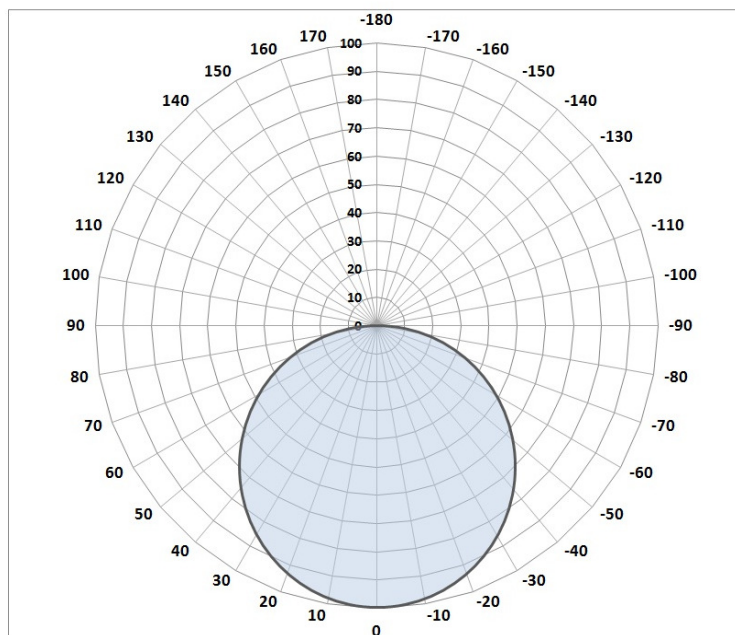

3-6. Thermal Management

(1) Tc Point : See the below red mark.

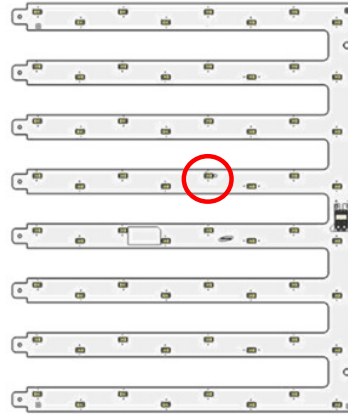
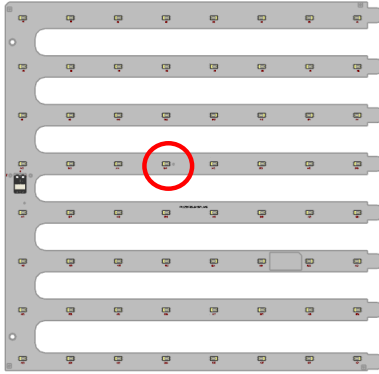

(2) Tc_life : Max temperature to reach 50,000 hours
 - 65°C for 50,000 @ L70B50

3-7. Circuit Diagram

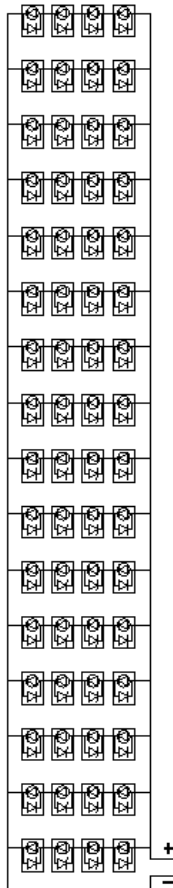



LED Module

Rev. No

Page

1.2

13 / 15

4. Approbation

Item	Compliant to	Result / Remark
General	Eye safety : IEC62471	LM561B LED
Hazardous Substance & Materials	ROHS	Declared
	Reach	Declared
Certification	CE	EN 62031:2008 EN 62471:2008
	ENEC	EN 62031:2008 EN 62471:2008
	UL / cUL	E 344519

5. Packing

(1) Box Dimension : 365 (L) x 332 (W) x 267 (h) [mm]

-	1 Tray	1 Box	1 Pallet
Num. of modules	4	60	1080 (18 boxes)

(2) Pallet Dimension : 1200 (L) x 800 (W) x 145 (h) [mm]

6. Precautions In Handling

- 1) LED Lighting for white light are devices which are materialized by combining white LEDs.
The color of white light can differ a little unusually to diffuser plate(sign-board panel).
- 2) Handling
 - Don't drop the unit and don't give the unit any shocks.
 - Don't storage the Module in a dusty place or room.
 - Don't take the unit to pieces.
- 3) Cleaning
 - This LED Module should not be used in any type of fluid such as oil, organic solvent, etc.
 - It is recommended that IPA(Isopropyl Alcohol) be used as a solvent for cleaning the LED Module.
 - When using other solvents, it should be confirmed beforehand whether the solvents will dissolve the package and the resin or not. Freon solvents should not be used to clean the LEDs because of worldwide regulations. Do not clean the LED Module by the ultrasonic.
 - Before cleaning, a pre-test should be done to confirm whether any damage to the LED Lighting will occur.
- 4) Static Electricity
 - Static electricity or surge voltage damages the LED Lighting.
- 5) Discoloration
 - VOCs (volatile organic compounds) may be occurred by adhesives, flux, hardener or organic additives which is used in luminaires (fixture) and LED silicone bags are permeable to it. It may lead a discoloration when LED expose to heat or light.
 - This phenomenon can give a significant loss of light emitted(output) from the luminaires(fixture).
 - In order to prevent these problems, we recommend you to know the physical properties for the materials used in luminaires, it requires to select carefully.
- 6) Risk of Sulfurization (or Tarnishing)
 - The lead frame from Samsung Electronics is a plated package and it may change to black (or dark colored) when it is exposed to Ag (a), Sulfur (S), Cchlorine (Cl) or other halogen compound. It requires attention.
 - Sulfide (Sulfurization) of the lead frame may cause a change of degradation intensity, chromaticity coordinates and it may cause open circuit in extreme cases. It requires attention.
 - Sulfide (Sulfurization) of the lead frame may cause of storage and using with oxidizing substances together. Therefore, LED is not recommend to use and store with the below list.
 - : Rubber, Plain paper, lead solder cream etc.

7) Others

- If over voltage which exceeds the absolute maximum rating is applied to LED Lighting, it will cause damage Circuits(that LED is included) and result in destruction.
- Do not directly look into lighted LED with naked eyes for long time.

Samsung-Electronics may make changes to specifications and product descriptions at any time, without notice.

All rights reserved © 2014 Samsung Electronics Co., Ltd.

This is the last page.

Looking for pricing, stock, or lifecycle information?

Click below to explore more details on WIN SOURCE:

- ⊖ [View SI-B8U101250WW](#) on WIN SOURCE
- ⊖ [Samsung](#) Information

Optimize Your Supply Chain with WIN SOURCE Solutions

- ✓ Global Sourcing Solution
- ✓ Obsolete Management
- ✓ Cost Control Management
- ✓ Shortage Management
- ✓ Alternative Solution
- ✓ Excess Inventory Management