



**THE DATASHEET OF
SPHWW1HDN945YHU2KH**



High Power LED Series Chip on Board

LC008B Gen.2



High efficacy COB LED package,
well-suited for use in spotlight applications

Features & Benefits

- Chip on Board (COB) solution makes it easy to design in
- Simple assembly reduces manufacturing cost
- Low thermal resistance
- InGaN/GaN MQW LED with long time reliability
- Completed 6,000 hours of LM-80 Testing

Applications

- Spotlight / Downlight
- LED Retrofit Bulbs
- Outdoor Illumination



Table of Contents

1.	Characteristics	-----	3
2.	Product Code Information	-----	6
3.	Typical Characteristics Graphs	-----	12
4.	Outline Drawing & Dimension	-----	15
5.	Reliability Test Items & Conditions	-----	16
6.	Label Structure	-----	17
7.	Packing Structure	-----	19
8.	Precautions in Handling & Use	-----	22

1. Characteristics

a) Absolute Maximum Rating

Item	Symbol	Rating	Unit	Condition
Ambient / Operating Temperature	T_a	-40 ~ +105	°C	-
Storage Temperature	T_{stg}	-40 ~ +120	°C	-
LED Junction Temperature	T_j	140	°C	-
Case Temperature	T_c	105	°C	*Note
Forward Current	I_F	430	mA	-
Power Dissipation	P_D	15.8	W	-
ESD (HBM)	-	±2	kV	-
ESD (MM)	-	±0.5	kV	-

b) Electro-optical Characteristics ($I_F = 240$ mA, $T_a = 25$ °C)

Item	Unit	Rank	Min.	Typ.	Max.
Forward Voltage (V_F)	V	YH	33.5	36.5	39.5
		3	70	-	-
		5	80	-	-
Color Rendering Index (R_a)	-	7	90	-	-
		8	95	-	-
Thermal Resistance (junction to chip point)	°C/W		-	2.0	-
Beam Angle	°		-	115	-
Working Voltage for Insulation	V				60
Nominal Power	W			8.6	
Eye Protection		Risk 1	-		-

Notes:

- 1) The COB is tested in pulsed condition at rated test current (10 ms pulse width) and rated temperature ($T_j = T_c = T_a = 25$ °C)
- 2) Samsung maintains measurement tolerance of: forward voltage = ± 5 %, CRI = ± 1
- 3) Max $T_c=105$ °C is for ENEC condition. Refer to the derating curve, '3. Typical Characteristics Graph' designed within the range.

c) Luminous Flux Characteristics ($I_F = 240 \text{ mA}$, $T_a = 25 \text{ }^\circ\text{C}$)

CRI (R_a) Min.	Nominal CCT (K)	Flux Rank	Flux Bin	Sorting ¹⁾ @ $T_c = 25 \text{ }^\circ\text{C}$ (lm)		Calculated Flux ²⁾ @ $T_c = 85 \text{ }^\circ\text{C}$ (lm)	
				Min.	Max.	Min.	Max.
70	3000	MG	M1	1064	1209	958	1088
			M2	1209	1354	1088	1219
	4000	MG	M1	1117	1270	1006	1143
			M2	1270	1422	1143	1280
	5000	MG	M1	1128	1282	1015	1154
			M2	1282	1436	1154	1292
80	2700	KG	K3	1041	1114	947	1014
			K4	1114	1187	1014	1080
		KH	K4	1114	1187	1014	1080
	3000	KG	K3	1108	1185	1008	1078
			K4	1185	1263	1078	1149
		KH	K4	1185	1263	1078	1149
	3500	KG	K3	1141	1221	1038	1111
			K4	1221	1300	1111	1183
		KH	K4	1221	1300	1111	1183
	4000	KG	K3	1174	1256	1068	1143
			K4	1256	1338	1143	1218
		KH	K4	1256	1338	1143	1218
	5000	KG	K3	1185	1268	1078	1154
			K4	1268	1351	1154	1229
		KH	K4	1268	1351	1154	1229
	5700	KG	K3	1185	1268	1078	1154
			K4	1268	1351	1154	1229
		KH	K4	1268	1351	1154	1229

c) Luminous Flux Characteristics ($I_F = 240 \text{ mA}$, $T_a = 25 \text{ }^\circ\text{C}$)

CRI (R_a) Min.	Nominal CCT (K)	Flux Rank	Flux Bin	Sorting ¹⁾ @ $T_c = 25 \text{ }^\circ\text{C}$ (lm)		Calculated Flux ²⁾ @ $T_c = 85 \text{ }^\circ\text{C}$ (lm)		
				Min.	Max.	Min.	Max.	
90	2700	FH	F3	933	1008	849	917	
			F4	1008	1083	917	985	
	3000	FH	F3	952	1029	867	936	
			F4	1029	1105	936	1005	
	3500	FH	F3	981	1060	893	964	
			F4	1060	1138	964	1036	
	4000	FH	F3	1010	1090	919	992	
			F4	1090	1171	992	1066	
	95	2700	EC	E1	756	840	688	764
				E2	840	924	764	841
3000		EC	E1	779	866	709	788	
			E2	866	953	788	867	
3500		EC	E1	803	892	731	812	
			E2	892	981	812	893	

Notes:

- 1) The COB is tested in pulsed condition at rated test current (10 ms pulse width) and rated temperature ($T_j = T_c = T_a = 25 \text{ }^\circ\text{C}$)
- 2) Calculated flux values are for reference only
- 3) Samsung maintains measurement tolerance of: luminous flux = $\pm 7 \%$, CRI = ± 1

2. Product Code Information

1	2	3	4	5	6	7	8	9	10	11	12	13	14	15	16	17	18
S	P	H	C	W	1	H	D	N	9	4	5	Y	H	R	T	K	E

Digit	PKG Information	Code	Specification
1 2 3	Samsung Package High Power	SPH	
4 5	Color	WW CW	Warm White (T/U/V/W Ranks) Cool White (Q/R Ranks)
6	Product Version	1	
7 8	Form Factor	HD	COB
9	Lens Type	N	No lens
10	Internal Code	9	LC008
11	Chip Type	4	
12	CRI & Sorting Temperature	3 5 7 8	Min. 70 Min. 80 25 °C Min. 90 Min 95
13 14	Forward Voltage (V)	YH	33.5~39.5
15	CCT (K)	W V U T R Q	2700 K WA, WB (MacAdam Ellipse) 3000 K VA, VB (MacAdam Ellipse) VW, VX, VY, VZ (ANSI bin) 3500 K UA, UB (MacAdam Ellipse) 4000 K TA, TB (MacAdam Ellipse) TW, TX, TY, TZ (ANSI bin) 5000 K RA (MacAdam Ellipse) RW, RX, RY, RZ (ANSI bin) 5700 K QW, QX, QY, QZ (ANSI bin)
16	MacAdam / ANSI	2 3 T	MacAdam 2-step MacAdam 3-step ANSI bin
17 18	Luminous Flux	MG KG KH FH EC	M1, M2 (70 CRI) K3, K4 (80 CRI) K4, K5 (80 CRI) F3, F4 (90 CRI) E1, E2 (95 CRI)

a) Binning Structure ($I_F = 240 \text{ mA}$, $T_a = 25 \text{ }^\circ\text{C}$)

CRI (R _a) Min.	Nominal CCT (K)	Product Code	V _F Rank	Color Rank	Chrom. Bin	Flux Rank	Flux Bin	Flux Range (Φ _v , lm)
70	3000	SPHWW1HDN943YHVTMG	YH	VT	VW, VX VY, VZ	MG	M1	1064 ~ 1209
							M2	1209 ~ 1354
	4000	SPHWW1HDN943YHTTMG	YH	TT	TW, TX TY, TZ	MG	M1	1117 ~ 1270
							M2	1270 ~ 1422
	5000	SPHCW1HDN943YHRTMG	YH	RT	RW, RX RY, RZ	MG	M1	1128 ~ 1282
							M2	1282 ~ 1436
80	2700	SPHWW1HDN945YHW2KG	YH	W2	WB	KG	K3	1041 ~ 1114
							K4	1114 ~ 1187
		SPHWW1HDN945YHW3KG	YH	W3	WA, WB	KG	K3	1041 ~ 1114
							K4	1114 ~ 1187
		SPHWW1HDN945YHW2KH	YH	W2	WB	KH	K4	1114 ~ 1187
							K5	1187 ~ 1260
	SPHWW1HDN945YHW3KH	YH	W3	WA, WB	KH	K4	1114 ~ 1187	
						K5	1187 ~ 1260	
	3000	SPHWW1HDN945YHV2KG	YH	V2	VB	KG	K3	1108 ~ 1185
							K4	1185 ~ 1263
		SPHWW1HDN945YHV3KG	YH	V3	VA, VB	KG	K3	1108 ~ 1185
							K4	1185 ~ 1263
		SPHWW1HDN945YHV2KH	YH	V2	VB	KH	K4	1185 ~ 1263
							K5	1263 ~ 1340
	SPHWW1HDN945YHV3KH	YH	V3	VA, VB	KH	K4	1185 ~ 1263	
						K5	1263 ~ 1340	
	3500	SPHWW1HDN945YHU2KG	YH	U2	UB	KG	K3	1141 ~ 1221
							K4	1221 ~ 1300
		SPHWW1HDN945YHU3KG	YH	U3	UA, UB	KG	K3	1141 ~ 1221
							K4	1221 ~ 1300
		SPHWW1HDN945YHU2KH	YH	U2	UB	KH	K4	1221 ~ 1300
							K5	1300 ~ 1380
	SPHWW1HDN945YHU3KH	YH	U3	UA, UB	KH	K4	1221 ~ 1300	
						K5	1300 ~ 1380	
4000	SPHWW1HDN945YHT2KG	YH	T2	TB	KG	K3	1174 ~ 1256	
						K4	1256 ~ 1338	
	SPHWW1HDN945YHT3KG	YH	T3	TA, TB	KG	K3	1174 ~ 1256	
						K4	1256 ~ 1338	
	SPHWW1HDN945YHT2KH	YH	T2	TB	KH	K4	1256 ~ 1338	
						K4	1256 ~ 1338	
SPHWW1HDN945YHT3KH	YH	T3	TA, TB	KH	K4	1256 ~ 1338		
					K4	1256 ~ 1338		
5000	SPHCW1HDN945YHR3KG	YH	R3	RA	KG	K3	1185 ~ 1268	
						K4	1268 ~ 1351	
	SPHCW1HDN945YHRTKG	YH	RT	RW, RX, RY, RZ	KG	K3	1185 ~ 1268	
						K4	1268 ~ 1351	
	SPHCW1HDN945YHR3KH	YH	R3	RA	KH	K4	1268 ~ 1351	
						K4	1268 ~ 1351	
SPHCW1HDN945YHRTKH	YH	RT	RW, RX, RY, RZ	KH	K4	1268 ~ 1351		
					K4	1268 ~ 1351		
5700	SPHCW1HDN945YHQTKG	YH	QT	QW, QX, QY, QZ	KG	K3	1185 ~ 1268	
						K4	1268 ~ 1351	
SPHCW1HDN945YHQTKH	YH	QT	QW, QX, QY, QZ	KH	K4	1268 ~ 1351		
					K4	1268 ~ 1351		

a) Binning Structure ($I_F = 240 \text{ mA}$, $T_a = 25 \text{ }^\circ\text{C}$)

CRI (R _a) Min.	Nominal CCT (K)	Product Code	V _F Rank	Color Rank	Chrom. Bin	Flux Rank	Flux Bin	Flux Range (Φ _v , lm)	
90	2700	SPHWW1HDN947YHW2FG	YH	W2	WB	FG	F3	933 ~ 1008	
							F4	1008 ~ 1083	
		SPHWW1HDN947YHW3FG	YH	W3	WA, WB	FG	F3	933 ~ 1008	
							F4	1008 ~ 1083	
	3000	SPHWW1HDN947YHV2FG	YH	V2	VB	FG	F3	952 ~ 1029	
							F4	1029 ~ 1105	
		SPHWW1HDN947YHV3FG	YH	V3	VA, VB	FG	F3	952 ~ 1029	
							F4	1029 ~ 1105	
	3500	SPHWW1HDN947YHU2FG	YH	U2	UB	FG	F3	981 ~ 1060	
							F4	1060 ~ 1138	
		SPHWW1HDN947YHU3FG	YH	U3	UA, UB	FG	F3	981 ~ 1060	
							F4	1060 ~ 1138	
	4000	SPHWW1HDN947YHT2FG	YH	T2	TB	FG	F3	1010 ~ 1090	
							F4	1090 ~ 1171	
		SPHWW1HDN947YHT3FG	YH	T3	TA, TB	FG	F3	1010 ~ 1090	
							F4	1090 ~ 1171	
	95	2700	SPHWW1HDN948YHW2EC	YH	W2	WB	EC	E1	756 ~ 840
								E2	840 ~ 924
SPHWW1HDN948YHW3EC			YH	W3	WA, WB	EC	E1	756 ~ 840	
							E2	840 ~ 924	
3000		SPHWW1HDN948YHV2EC	YH	V2	VB	EC	E1	779 ~ 866	
							E2	866 ~ 953	
		SPHWW1HDN948YHV3EC	YH	V3	VA, VB	EC	E1	779 ~ 866	
							E2	866 ~ 953	
3500		SPHWW1HDN948YHU2EC	YH	U2	UB	EC	E1	803 ~ 892	
							E2	892 ~ 981	
		SPHWW1HDN948YHU3EC	YH	U3	UA, UB	EC	E1	803 ~ 892	
							E2	892 ~ 981	

b) Chromaticity Region & Coordinates ($I_F = 240 \text{ mA}$, $T_a = 25 \text{ }^\circ\text{C}$)

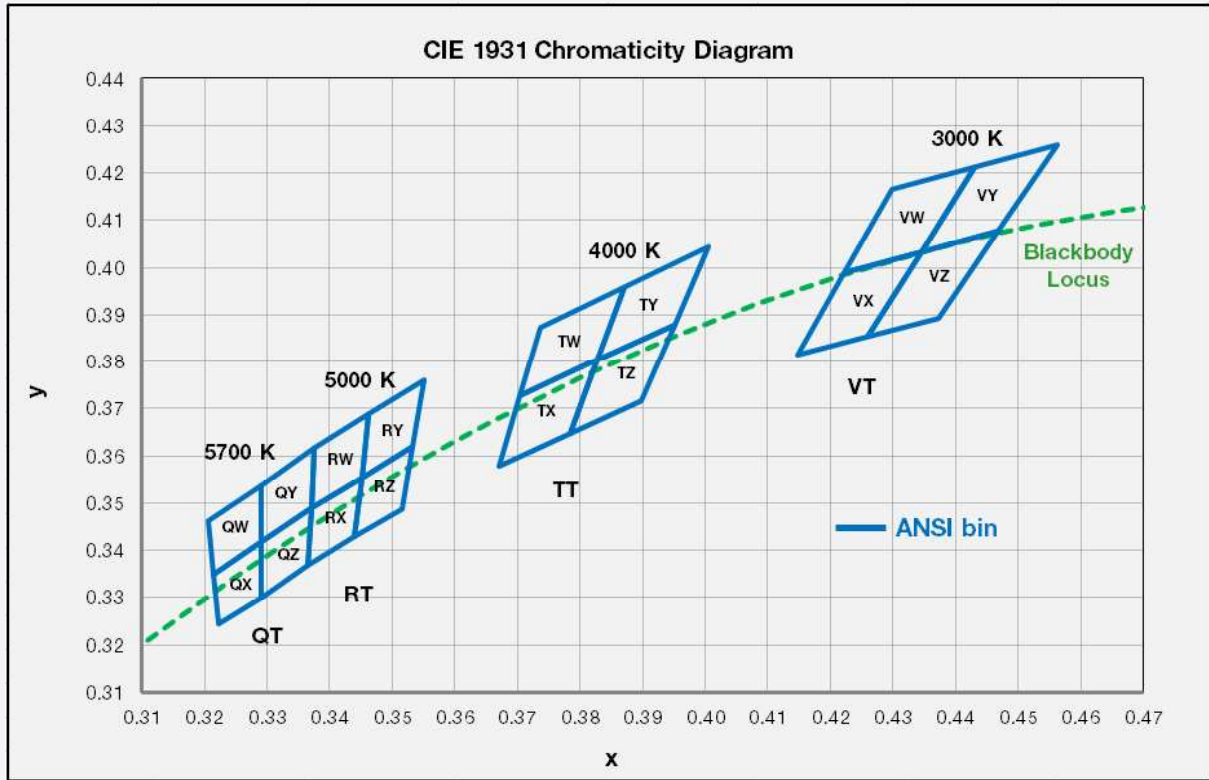

Region	CIE x	CIE y	Region	CIE x	CIE y
V rank (3000 K)					
VW	0.4223	0.399	VY	0.4345	0.4033
	0.4345	0.4033		0.4468	0.4077
	0.4431	0.4213		0.4562	0.4260
VX	0.4299	0.4165	VZ	0.4431	0.4213
	0.4223	0.399		0.4260	0.3854
	0.4147	0.3814		0.4373	0.3893
	0.4260	0.3854		0.4468	0.4077
	0.4345	0.4033		0.4345	0.4033
R rank (5000 K)					
RW	0.3376	0.3616	RY	0.3463	0.3687
	0.3463	0.3687		0.3551	0.3760
	0.3451	0.3554		0.3533	0.3620
	0.3371	0.3490		0.3451	0.3554
RX	0.3371	0.3490	RZ	0.3451	0.3554
	0.3451	0.3554		0.3533	0.3620
	0.3440	0.3428		0.3515	0.3487
	0.3366	0.3369		0.3440	0.3428

Region	CIE x	CIE y	Region	CIE x	CIE y
T rank (4000 K)					
TW	0.3736	0.3874	TY	0.3871	0.3959
	0.3871	0.3959		0.4006	0.4044
	0.3828	0.3803		0.3952	0.388
	0.3703	0.3726		0.3828	0.3803
TX	0.3703	0.3726	TZ	0.3828	0.3803
	0.3828	0.3803		0.3952	0.388
	0.3784	0.3647		0.3898	0.3716
	0.367	0.3578		0.3784	0.3647
Q rank (5700 K)					
QW	0.3207	0.3462	QY	0.3290	0.3538
	0.3290	0.3538		0.3376	0.3616
	0.3290	0.3417		0.3371	0.3490
	0.3215	0.3350		0.3290	0.3417
QX	0.3215	0.3350	QZ	0.3290	0.3417
	0.3290	0.3417		0.3371	0.3490
	0.3290	0.3300		0.3366	0.3369
	0.3222	0.3243		0.3290	0.3300



b) Chromaticity Region & Coordinates ($I_F = 240 \text{ mA}$, $T_a = 25 \text{ }^\circ\text{C}$)



MacAdam Ellipse (WA, WB)					
Step	CIE x	CIE y	θ	a	b
2-step	0.4578	0.4101	53.70	0.0054	0.0028
3-step	0.4578	0.4101	53.70	0.0081	0.0042

MacAdam Ellipse (VA, VB)					
Step	CIE x	CIE y	θ	a	b
2-step	0.4338	0.403	53.22	0.0056	0.0027
3-step	0.4338	0.4030	53.22	0.0083	0.0041

MacAdam Ellipse (UA, UB)					
Step	CIE x	CIE y	θ	a	b
2-step	0.4073	0.3917	54.00	0.0062	0.0028
3-step	0.4073	0.3917	54.00	0.0093	0.0041

MacAdam Ellipse (TA, TB)					
Step	CIE x	CIE y	θ	a	b
2-step	0.3818	0.3797	53.72	0.0063	0.0027
3-step	0.3818	0.3797	53.72	0.0094	0.0040

MacAdam Ellipse (RA)					
Step	CIE x	CIE y	θ	a	b
3-step	0.3447	0.3553	59.62	0.0082	0.0035

Note:

Samsung maintains measurement tolerance of: $C_x, C_y = \pm 0.005$



3. Typical Characteristics Graphs

a) Spectrum Distribution ($I_F = 240 \text{ mA}$, $T_a = 25 \text{ }^\circ\text{C}$)

CCT: 2700 K



CCT: 3000 K



CCT: 3500 K

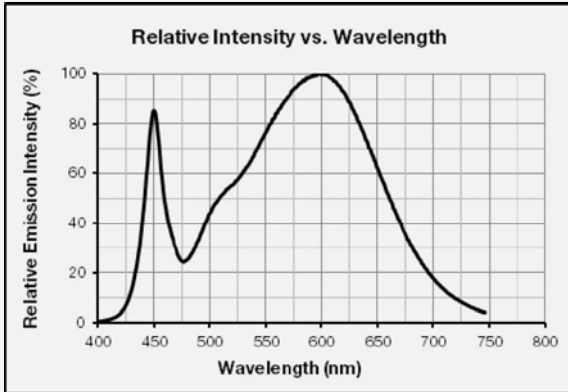

CCT: 4000 K

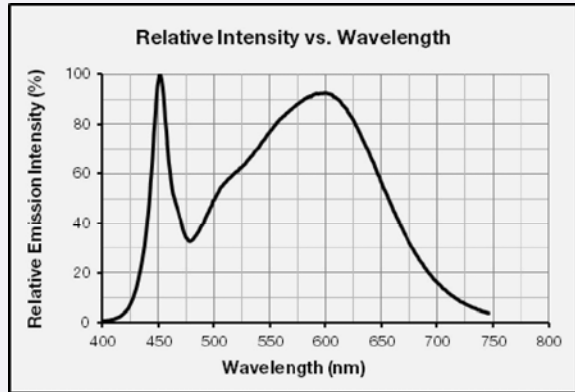

CCT: 5000 K

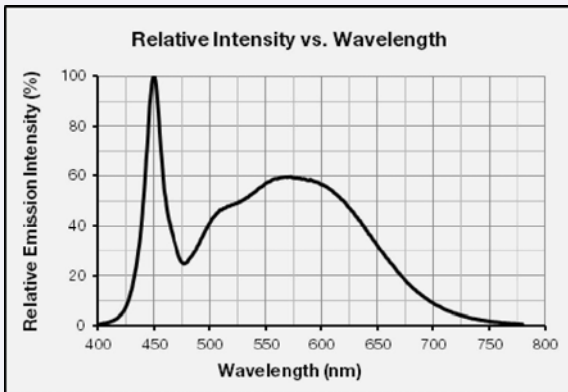

CCT: 5700 K

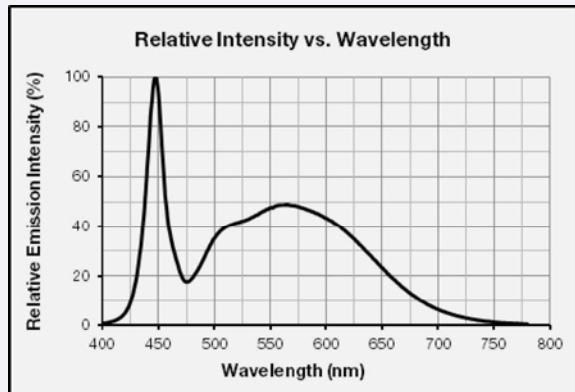

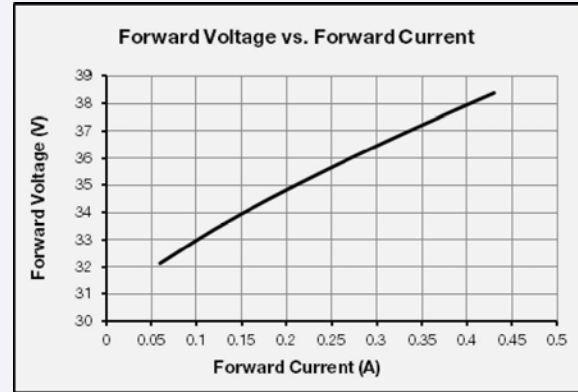
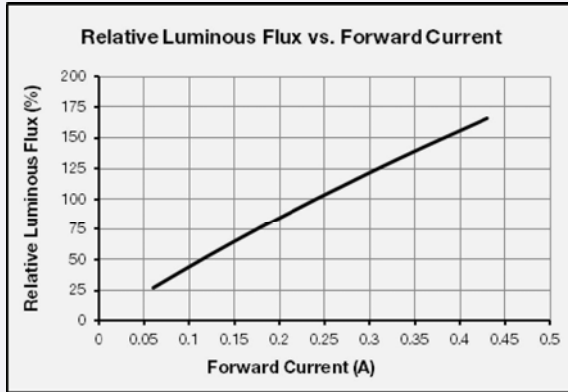
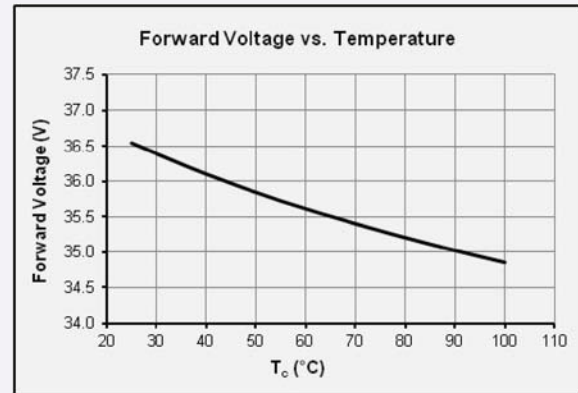
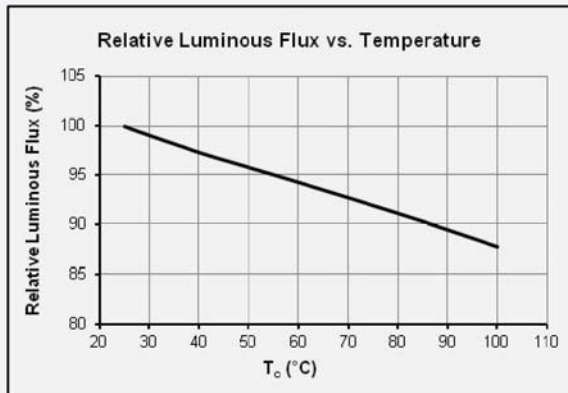
b) Forward Current Characteristics ($T_a = 25^\circ\text{C}$)c) Temperature Characteristics ($I_F = 240\text{ mA}$)

d) Color Shift Characteristics

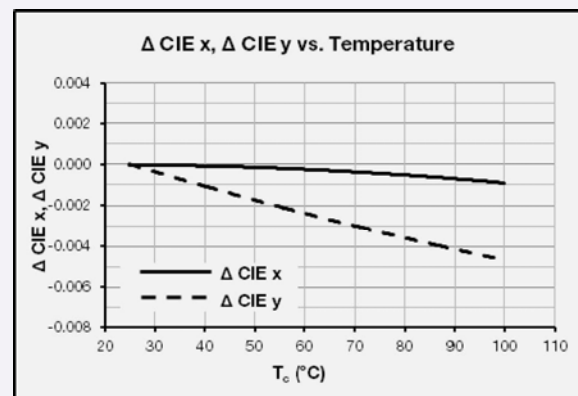
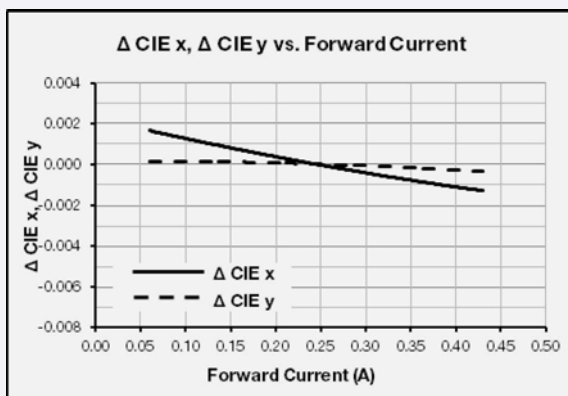
 $T_a = 25^\circ\text{C}$ $I_F = 240\text{ mA}$ 

e) Derating Curve

f) Beam Angle Characteristics ($I_F = 240$ mA, $T_a = 25$ °C)

4. Outline Drawing & Dimension

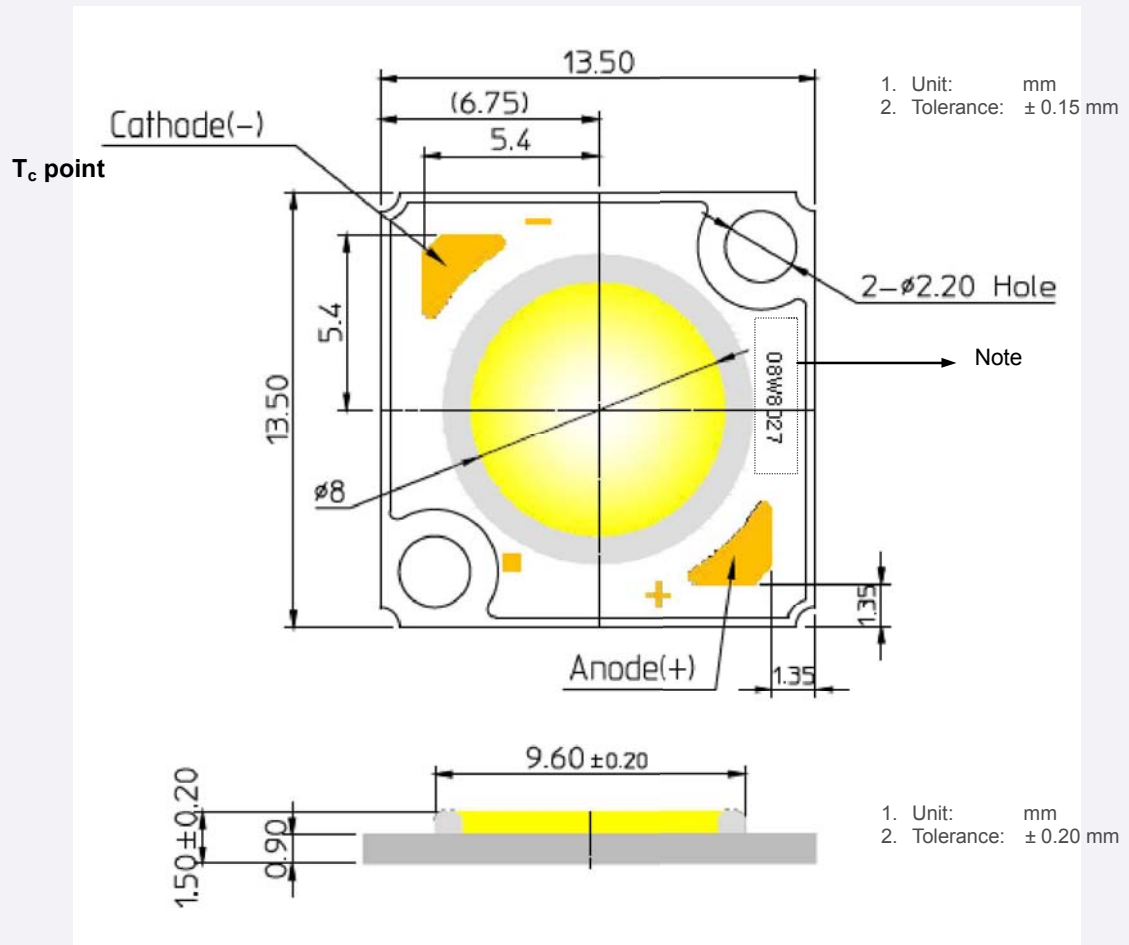

Item	Dimension	Tolerance	Unit
Length	13.50	±0.15	mm
Width	13.50	±0.15	mm
Height	1.50	±0.20	mm
Light Emitting Surface (LES) Diameter	8	±0.15	mm
Screw Hole Size	2.2	±0.15	mm

Note: Denoted product information above is only an example
(08W8027 : 8.6W, CRI80+, 2700K)

5. Reliability Test Items & Conditions

a) Test Items

Test Item	Test Condition	Test Hour / Cycle
Room Temperature Life Test	25 °C, $I_F = \text{max}$	1000 h
High Temperature Humidity Life Test	60 °C, 90 % RH, DC Derating, $I_F = \text{max}$	1000 h
High Temperature Life Test	105 °C, DC Derating, $I_F = \text{max}$	1000 h
Low Temperature Life Test	-40 °C, DC 430 mA	1000 h
High Temperature Storage	120 °C	1000 h
Low Temperature Storage	-40 °C	1000 h
Thermal Shock	-45 °C / 15 min ↔ 125 °C / 15 min temperature change in 5 min	200 cycles
Temperature Cycle On/Off Test	-40 °C / 85 °C each 20 min, 100 min transfer power on/off each 5 min, DC 240 mA	100 cycles
ESD (HBM)	R_1 : 10 M Ω R_2 : 1.5 k Ω C: 100 pF V: ± 2 kV	5 times
ESD (MM)	R_1 : 10 M Ω R_2 : 0 k Ω C: 200 pF V: ± 0.5 kV	5 times
Vibration Test	20 ~ 80 Hz (displacement: 0.06 inch, max. 20 g) 80 ~ 2 kHz (max. 20 g) min. frequency ↔ max. frequency 4 min transfer	4 times
Mechanical Shock Test	1500 g, 0.5 ms each of the 6 surfaces (3 axis x 2 sides)	5 times
Salt Spray Test	35 °C, 5 % salt water 8 h spray, 16 h dwell	2 cycles

b) Criteria for Judging the Damage

Item	Symbol	Test Condition ($T_C = 25$ °C)	Limit	
			Min.	Max.
Forward Voltage	V_F	$I_F = 240$ mA	L.S.L. * 0.9	U.S.L. * 1.1
Luminous Flux	Φ_v	$I_F = 240$ mA	L.S.L. * 0.7	U.S.L. * 1.3

6. Label Structure

a) Label Structure

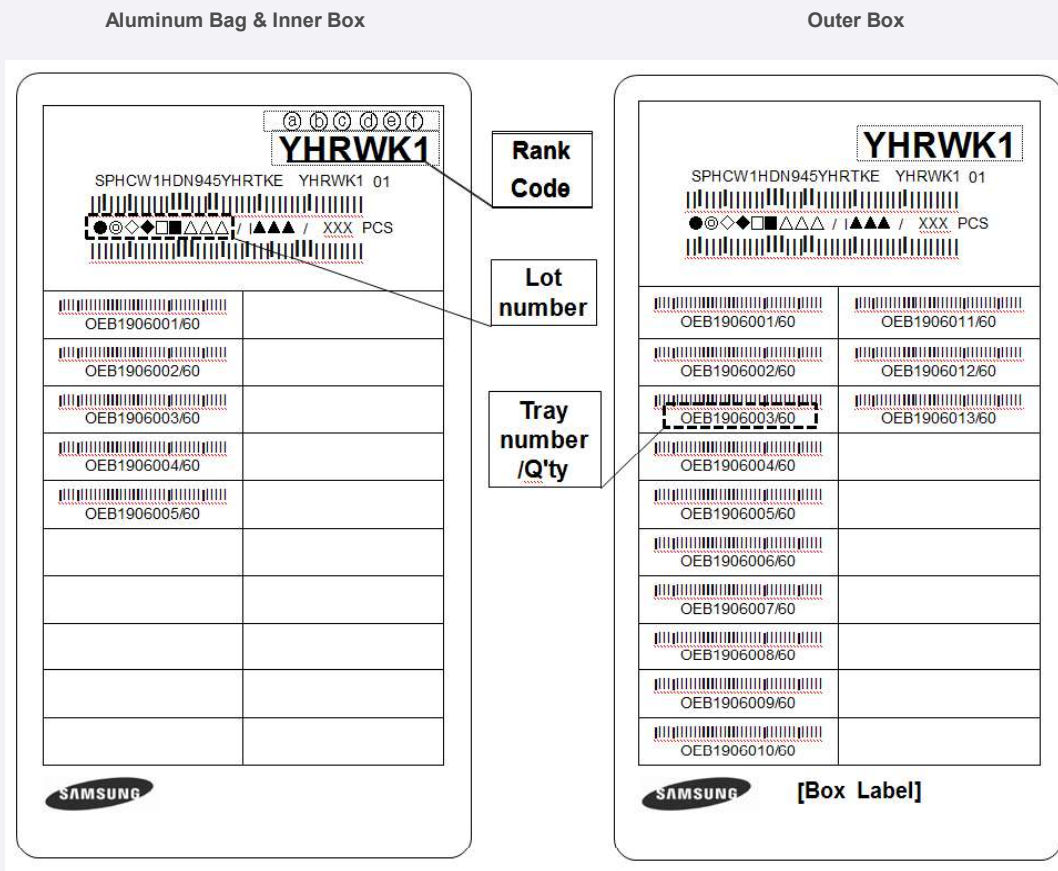

Note: Denoted rank code and product code above is only an example (see description on page 5)

Rank Code:

ⒶⒷ: Forward Voltage rank (refer to page 6-7)

ⒸⒹ: Chromaticity bin (refer to page 8-9)

ⒺⒻ: Luminous Flux bin (refer to page 6-7)

b) Lot Number

The lot number is composed of the following characters:

●◎◇◆□■△△△ / 1▲▲▲ / xxx PCS

- : Production site (S: Giheung, Korea, G: Tianjin, China)
- ◎ : L (LED)
- ◇ : Product state (A: Normal, B: Bulk, C: First Production, R: Reproduction, S: Sample)
- ◆ : Year (Y: 2014, Z: 2015, A: 2016, ...)
- : Month (1~9, A, B, C)
- : Day (1~9, A, B~V)
- △△△ : Product serial number (001 ~ 009)
- ▲▲▲ : Tray number (001 ~ 999)

7. Packing Structure

Packing material	Max. quantity in pcs of COB	Dimension (mm)			
		Length	Width	Height	Tolerance
Tray	84	322.6	135.9	10.8	1.0
Aluminum Bag	672 (8 trays)	450	230	-	10
PE Foam Pad	-	280	130	10	2
Inner Box	672 (1 aluminum bag)	338	143	55	2
Outer Box	2,688 (4 inner boxes)	351	303	125	5
Pallet	150,528 (56 outer boxes)	1000	1000	130	10

a) Packing Structure

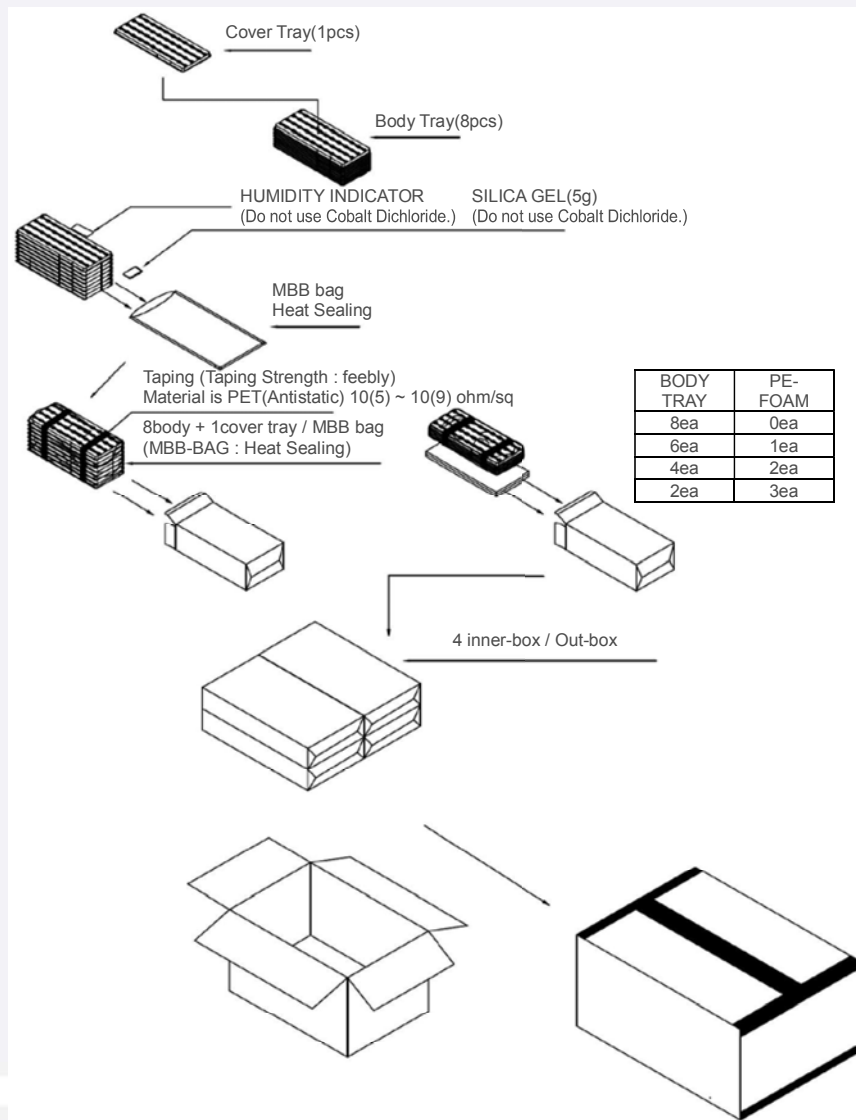

b) Tray

① COVER

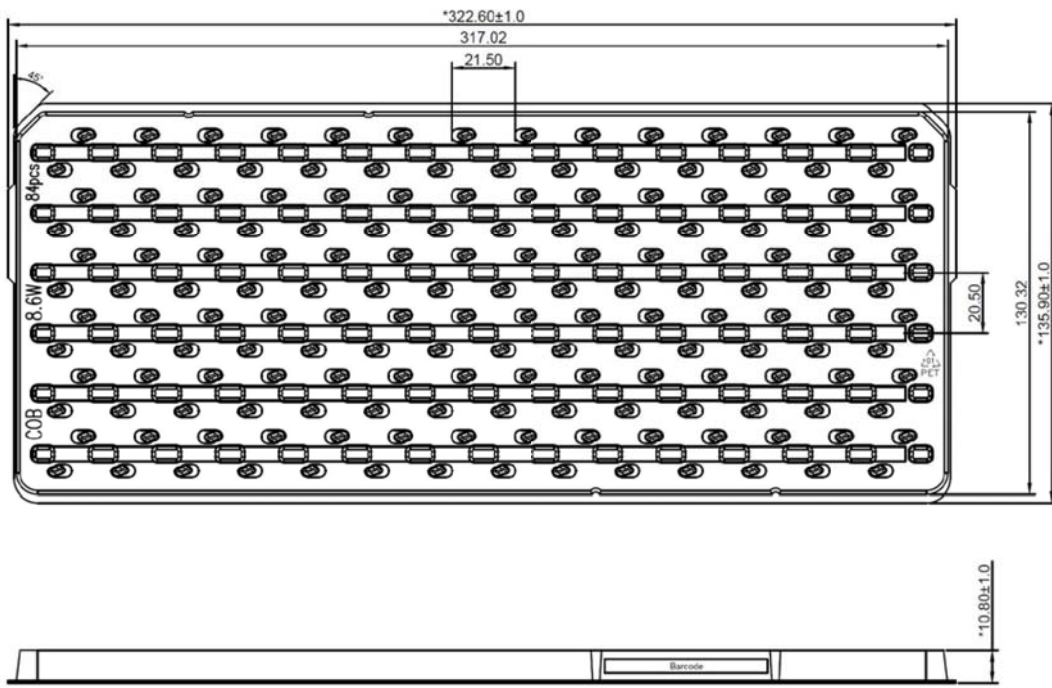

② BODY

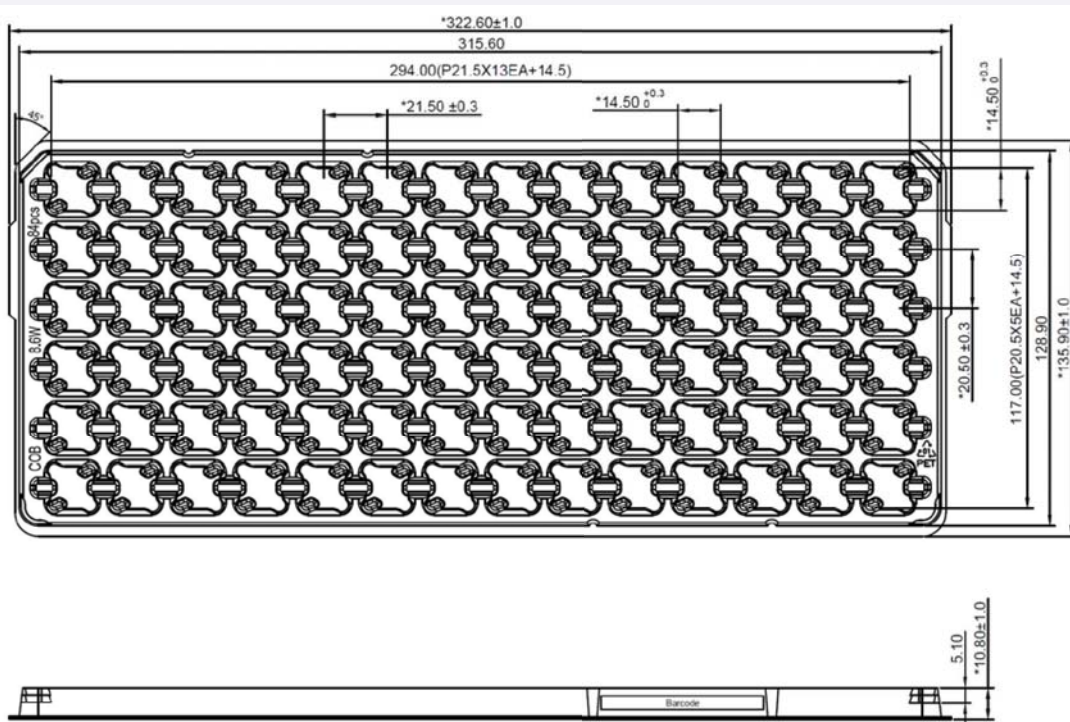

c) Aluminum Vinyl Packing Bag



d) Silica Gel & Humidity Indicator Card inside Aluminum Vinyl Packing Bag



8. Precautions in Handling & Use

- 1) This device should not be used in any type of fluid such as water, oil, organic solvent, etc. When cleaning is required, IPA is recommended as the cleaning agent. Some solvent-based cleaning agent may damage the silicone resins used in the device.
- 2) LEDs must be stored in a clean environment. If the LEDs are to be stored for three months or more after being shipped from Samsung, they should be packed with a nitrogen-filled container (shelf life of sealed bags is 12 months at temperature 0~40 °C, 0~90 % RH).
- 3) After storage bag is opened, device subjected to soldering, solder reflow, or other high temperature processes must be:
 - a. Mounted within 672 hours (28 days) at an assembly line with a condition of no more than 30 °C / 60 % RH, or
 - b. Stored at <10 % RH
- 4) Repack unused products with anti-moisture packing, fold to close any opening and then store in a dry place.
- 5) Devices require baking before mounting, if humidity card reading is >60 % at 23 ± 5 °C.
- 6) Devices must be baked for 1 hour at 60 ± 5 °C, if baking is required.
- 7) The LEDs are sensitive to the static electricity and surge current. It is recommended to use a wrist band or anti-electrostatic glove when handling the LEDs. If voltage exceeding the absolute maximum rating is applied to LEDs, it may cause damage or even destruction to LED devices. Damaged LEDs may show some unusual characteristics such as increase in leakage current, lowered turn-on voltage, or abnormal lighting of LEDs at low current.
- 8) VOCs (Volatile Organic Compounds) can be generated from adhesives, flux, hardener or organic additives used in luminaires (fixtures). Transparent LED silicone encapsulant is permeable to those chemicals and they may lead to a discoloration of encapsulant when they exposed to heat or light. This phenomenon can cause a significant loss of light emitted (output) from the luminaires. In order to prevent these problems, we recommend users to know the physical properties of materials used in luminaires and they must be carefully selected.
- 9) The resin area is very sensitive, please do not handle, press, touch, rub, clean, or pick by with tweezers on it. Instead, please pick at the handling area as indicated below.



Legal and additional information.

[About Samsung Electronics Co., Ltd.](#)

Samsung Electronics Co., Ltd. inspires the world and shapes the future with transformative ideas and technologies, redefining the worlds of TVs, smartphones, wearable devices, tablets, cameras, digital appliances, printers, medical equipment, network systems and semiconductors.

We are also leading in the Internet of Things space through, among others, our Digital Health and Smart Home initiatives. We employ 307,000 people across 84 countries. To discover more, please visit our official website at www.samsung.com and our official blog at global.samsungtomorrow.com.

Copyright © 2015 Samsung Electronics Co., Ltd. All rights reserved.

Samsung is a registered trademark of Samsung Electronics Co., Ltd.

Specifications and designs are subject to change without notice. Non-metric weights and measurements are approximate. All data were deemed correct at time of creation. Samsung is not liable for errors or omissions. All brand, product, service names and logos are trademarks and/or registered trademarks of their respective owners and are hereby recognized and acknowledged.

Samsung Electronics Co., Ltd.
95, Samsung 2-ro
Giheung-gu
Yongin-si, Gyeonggi-do, 446-711
KOREA

www.samsungled.com



Looking for pricing, stock, or lifecycle information?

Click below to explore more details on WIN SOURCE:

 [View SPHWW1HDN945YHU2KH on WIN SOURCE](#)

 [Samsung Information](#)

Optimize Your Supply Chain with WIN SOURCE Solutions

-  Global Sourcing Solution
-  Obsolete Management
-  Cost Control Management
-  Shortage Management
-  Alternative Solution
-  Excess Inventory Management