



**THE DATASHEET OF
SPHCW1HDN945YHQT B3**



High Power LED Series Chip on Board

LC008B - Gen3



High efficacy COB LED package,
well-suited for use in spotlight applications

Features & Benefits

- Chip on Board (COB) solution makes it easy to design in
- Simple assembly reduces manufacturing cost
- Low thermal resistance
- InGaN/GaN MQW LED with long time reliability
- Completed 6,000 hours of LM-80 Testing

Applications

- Spotlight / Downlight
- LED Retrofit Bulbs
- Outdoor Illumination



Table of Contents

1.	Characteristics	-----	3
2.	Product Code Information	-----	5
3.	Typical Characteristics Graphs	-----	10
4.	Outline Drawing & Dimension	-----	14
5.	Reliability Test Items & Conditions	-----	15
6.	Label Structure	-----	16
7.	Packing Structure	-----	17
8.	Precautions in Handling & Use	-----	19

1. Characteristics

a) Absolute Maximum Rating

Item	Symbol	Rating	Unit	Condition
Ambient / Operating Temperature	T_a	-40 ~ +105	°C	-
Storage Temperature	T_{stg}	-40 ~ +120	°C	-
LED Junction Temperature	T_j	140	°C	-
Case Temperature	T_c	105	°C	*Note
Forward Current	I_F	430	mA	-
Power Dissipation	P_D	15.8	W	-
ESD (HBM)	-	±2	kV	-
ESD (MM)	-	±0.5	kV	-

b) Electro-optical Characteristics ($I_F = 240 \text{ mA}$, $T_a = 25 \text{ °C}$)

Item	Unit	Rank	Min.	Typ.	Max.
Forward Voltage (V_F)	V	YH	32.5	35.5	38.5
Color Rendering Index (R_a)	-	5	80	-	-
		7	90	-	-
Thermal Resistance (junction to chip point)	°C/W		-	2.0	-
Beam Angle	°		-	115	-
Nominal Power	W			8.6	
Eye Protection		Risk 1	-		-

Notes:

- 1) The COB is tested in pulsed condition at rated test current (10 ms pulse width) and rated temperature ($T_j = T_c = T_a = 25 \text{ °C}$)
- 2) Samsung maintains measurement tolerance of: forward voltage = ±5 %, CRI = ±1
- 3) Refer to the derating curve, '3. Typical Characteristics Graph' designed within the range.

c) Luminous Flux Characteristics ($I_F = 240 \text{ mA}$)

CRI (R_a) Min.	Nominal CCT (K)	Flux Rank	Flux Bin	Sorting ¹⁾ @ $T_c = 25 \text{ }^\circ\text{C}$ (lm)		Calculated Flux ²⁾ @ $T_c = 85 \text{ }^\circ\text{C}$ (lm)		
				Min.	Max.	Min.	Max.	
80	2700	B3	K4	1114	1187	1014	1080	
			K5	1187	1260	1080	1147	
			K6	1260	1364	1146	1241	
	3000	B3	K4	1185	1263	1078	1149	
			K5	1263	1340	1149	1219	
			K6	1340	1446	1219	1316	
	3500	B3	K5	1263	1340	1149	1219	
			K4	1221	1300	1111	1183	
			K5	1300	1380	1183	1256	
	4000	B3	K6	1380	1491	1255	1357	
			K4	1256	1338	1143	1218	
			K5	1338	1421	1217	1293	
	5000	B3	K6	1421	1537	1293	1399	
			K5	1338	1421	1217	1293	
			K4	1268	1351	1154	1229	
	5700	B3	K5	1351	1434	1229	1304	
			K6	1434	1552	1304	1412	
			K4	1268	1351	1154	1229	
	6500	B3	K5	1351	1434	1229	1304	
			K6	1434	1552	1304	1412	
			K4	1231	1321	1120	1202	
	90	2700	B3	K5	1321	1393	1202	1268
				K6	1393	1507	1268	1371
				F3	933	1008	849	917
3000		B3	F4	1008	1083	917	985	
			F5	1083	1181	985	1075	
			F4	1008	1083	917	985	
3500		B3	F3	952	1029	867	936	
			F4	1029	1105	936	1005	
			F5	1105	1206	1005	1097	
4000		B3	F4	1029	1105	936	1005	
			F3	981	1060	893	964	
			F4	1060	1138	964	1036	
4000		B3	F5	1138	1242	1035	1130	
			F3	1010	1090	919	992	
			F4	1090	1171	992	1066	
4000		F4	F5	1171	1278	1065	1163	
			F4	1090	1171	992	1066	

Notes:

- 1) The COB is tested in pulsed condition at rated test current (10 ms pulse width) and rated temperature ($T_j = T_c = T_a = 25 \text{ }^\circ\text{C}$)
- 2) Calculated flux values are for reference only
- 3) Samsung maintains measurement tolerance of: luminous flux = $\pm 7 \%$, CRI = ± 1

2. Product Code Information

1	2	3	4	5	6	7	8	9	10	11	12	13	14	15	16	17	18
S	P	H	C	W	1	H	D	N	9	4	5	Y	H	R	T	B	3

Digit	PKG Information	Code	Specification
1 2 3	Samsung Package High Power	SPH	
4 5	Color	WW CW	Warm White (T/U/V/W Ranks) Cool White (Q/R Ranks)
6	Product Version	1	
7 8	Form Factor	HD	COB
9	Lens Type	N	No lens
10	Internal Code	9	LC008B
11	Chip Type	4	
12	CRI & Sorting Temperature	5 7	Min. 80 25 °C Min. 90
13 14	Forward Voltage (V)	YH	32.5~38.5
15	CCT (K)	W V U T R Q P	2700 K WA, WB (MacAdam Ellipse) 3000 K VA, VB (MacAdam Ellipse) VW, VX, VY, VZ (ANSI bin) 3500 K UA, UB (MacAdam Ellipse) 4000 K TA, TB (MacAdam Ellipse) Bin Code: TW, TX, TY, TZ (ANSI bin) 5000 K RA (MacAdam Ellipse) RW, RX, RY, RZ (ANSI bin) 5700 K QW, QX, QY, QZ (ANSI bin) 6500K PA (MacAdam Ellipse)
16	MacAdam / ANSI	2 3 T	MacAdam 2-step MacAdam 3-step ANSI bin
17 18	Luminous Flux	B3	Bin Code: K4, K5, K6 (80 CRI) F3, F4, F5 (90 CRI)

a) Binning Structure ($I_F = 240 \text{ mA}$, $T_a = 25 \text{ }^\circ\text{C}$)

CRI (Ra) Min.	Nominal CCT (K)	Product Code	V _F Rank	Color Rank	Chrom. Bin	Flux Rank	Flux Bin	Flux Range (Φ _v , lm)
80	2700	SPHWW1HDN945YHW2B3	YH	W2	WB	B3	K4	1114 ~ 1187
							K5	1187 ~ 1260
							K6	1260 ~ 1364
		SPHWW1HDN945YHW3B3	YH	W3	WA, WB	B3	K4	1114 ~ 1187
							K5	1187 ~ 1260
							K6	1260 ~ 1364
	3000	SPHWW1HDN945YHV2B3	YH	V2	VB	B3	K4	1185 ~ 1263
							K5	1263 ~ 1340
							K6	1340 ~ 1446
		SPHWW1HDN945YHV3B3	YH	V3	VA, VB	B3	K4	1185 ~ 1263
							K5	1263 ~ 1340
							K6	1340 ~ 1446
	3500	SPHWW1HDN945YHU2B3	YH	U2	UB	B3	K4	1221 ~ 1300
							K5	1300 ~ 1380
							K6	1380 ~ 1491
		SPHWW1HDN945YHU3B3	YH	U3	UA, UB	B3	K4	1221 ~ 1300
							K5	1300 ~ 1380
							K6	1380 ~ 1491
	4000	SPHWW1HDN945YHT2B3	YH	T2	TB	B3	K4	1256 ~ 1338
							K5	1338 ~ 1421
							K6	1421 ~ 1537
		SPHWW1HDN945YHT3B3	YH	T3	TA, TB	B3	K4	1256 ~ 1338
							K5	1338 ~ 1421
							K6	1421 ~ 1537
5000	SPHCW1HDN945YHR3B3	YH	R3	RA	B3	K4	1268 ~ 1351	
						K5	1351 ~ 1434	
						K6	1434 ~ 1552	
	SPHCW1HDN945YHRTB3	YH	RT	RW, RX, RY, RZ	B3	K4	1268 ~ 1351	
						K5	1351 ~ 1434	
						K6	1434 ~ 1552	
5700	SPHCW1HDN945YHQT3B3	YH	QT	QW, QX, QY, QZ	B3	K4	1268 ~ 1351	
						K5	1351 ~ 1440	
						K6	1434 ~ 1552	
	6500	SPHCW1HDN945YHP3B3	YH	P3	PA	B3	K4	1231 ~ 1321
							K5	1321 ~ 1393
							K6	1393 ~ 1507

a) Binning Structure ($I_F = 240 \text{ mA}$, $T_a = 25 \text{ }^\circ\text{C}$)

CRI (R _a) Min.	Nominal CCT (K)	Product Code	V _F Rank	Color Rank	Chrom. Bin	Flux Rank	Flux Bin	Flux Range (Φ _v , lm)
90	2700	SPHWW1HDN947YHW2B3	YH	W2	WB	B3	F3	933 ~ 1008
							F4	1008 ~ 1083
							F5	1083 ~ 1181
		SPHWW1HDN947YHW3B3	YH	W3	WA, WB	B3	F3	933 ~ 1008
							F4	1008 ~ 1083
							F5	1083 ~ 1181
	3000	SPHWW1HDN947YHV2B3	YH	V2	VB	B3	F3	952 ~ 1029
							F4	1029 ~ 1105
							F5	1105 ~ 1206
		SPHWW1HDN947YHV3B3	YH	V3	VA, VB	B3	F3	952 ~ 1029
							F4	1029 ~ 1105
							F5	1105 ~ 1206
	3500	SPHWW1HDN947YHU2B3	YH	U2	UB	B3	F3	981 ~ 1060
							F4	1060 ~ 1138
							F5	1138 ~ 1242
		SPHWW1HDN947YHU3B3	YH	U3	UA, UB	B3	F3	981 ~ 1060
							F4	1060 ~ 1138
							F5	1138 ~ 1242
4000	SPHWW1HDN947YHT2B3	YH	T2	TB	B3	F3	1010 ~ 1090	
						F4	1090 ~ 1171	
						F5	1171 ~ 1278	
	SPHWW1HDN947YHT3B3	YH	T3	TA, TB	B3	F3	1010 ~ 1090	
						F4	1090 ~ 1171	
						F5	1171 ~ 1278	

b) Chromaticity Region & Coordinates ($I_F = 240 \text{ mA}$, $T_a = 25 \text{ }^\circ\text{C}$)

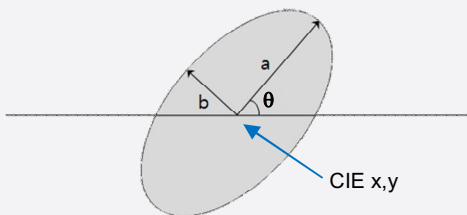
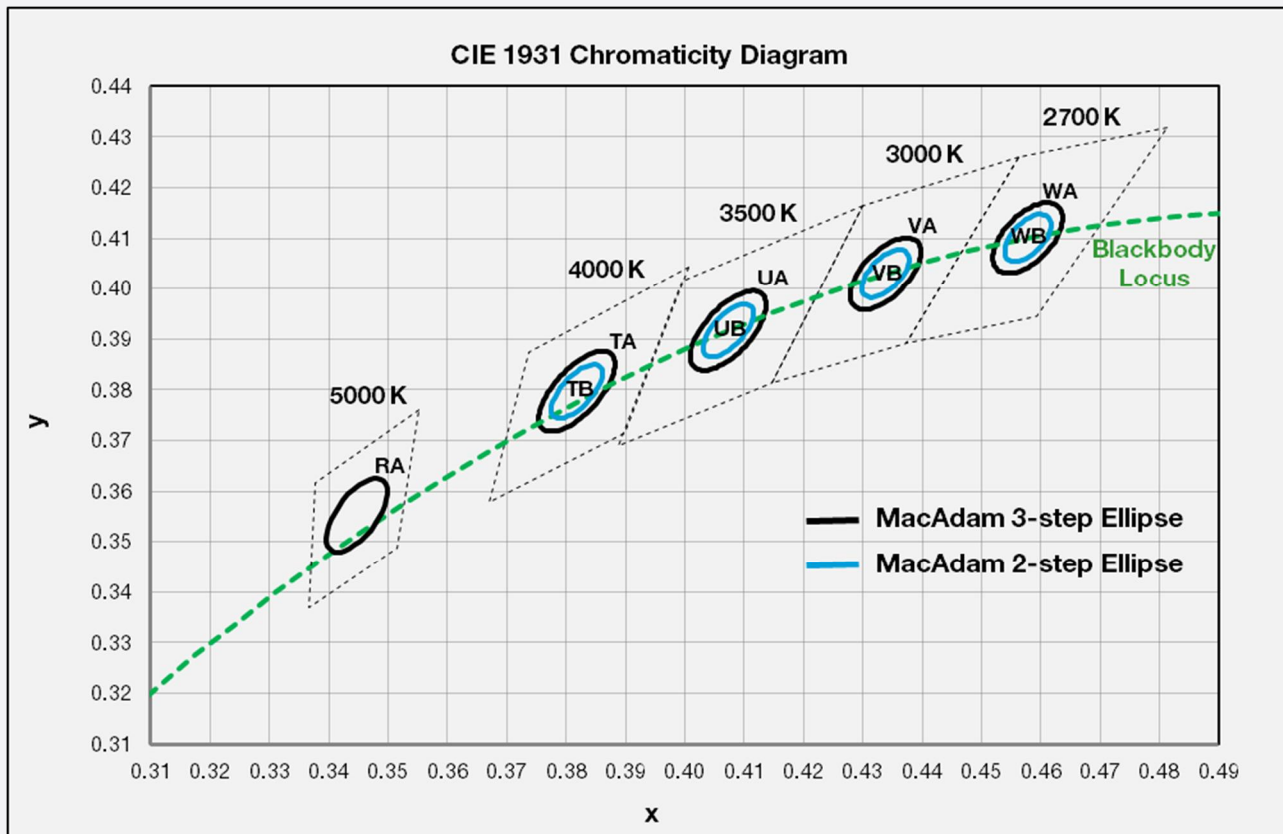

MacAdam Ellipse (WA, WB)					
Step	CIE x	CIE y	θ	a	b
2-step	0.4578	0.4101	53.70	0.0054	0.0028
3-step	0.4578	0.4101	53.70	0.0081	0.0042

MacAdam Ellipse (VA, VB)					
Step	CIE x	CIE y	θ	a	b
2-step	0.4338	0.403	53.22	0.0056	0.0027
3-step	0.4338	0.4030	53.22	0.0083	0.0041

MacAdam Ellipse (UA, UB)					
Step	CIE x	CIE y	θ	a	b
2-step	0.4073	0.3917	54.00	0.0062	0.0028
3-step	0.4073	0.3917	54.00	0.0093	0.0041

MacAdam Ellipse (TA, TB)					
Step	CIE x	CIE y	θ	a	b
2-step	0.3818	0.3797	53.72	0.0063	0.0027
3-step	0.3818	0.3797	53.72	0.0094	0.0040

MacAdam Ellipse (RA)					
Step	CIE x	CIE y	θ	a	b
3-step	0.3447	0.3553	59.62	0.0082	0.0035

Note:

Samsung maintains measurement tolerance of: $C_x, C_y = \pm 0.005$

3. Typical Characteristics Graphs

a) Spectrum Distribution ($I_f = 240 \text{ mA}$, $T_a = 25 \text{ }^\circ\text{C}$)

CCT: 2700 K (80 CRI)

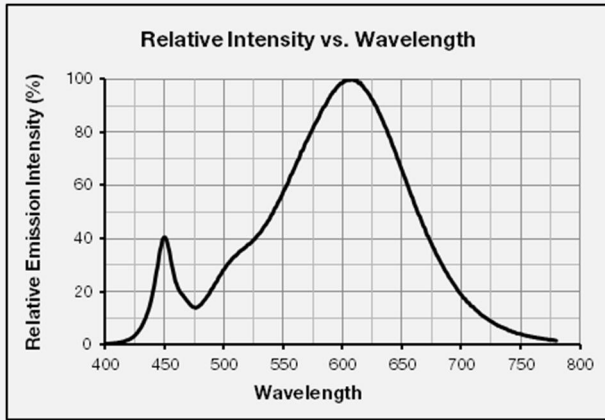

CCT: 3000 K (80 CRI)

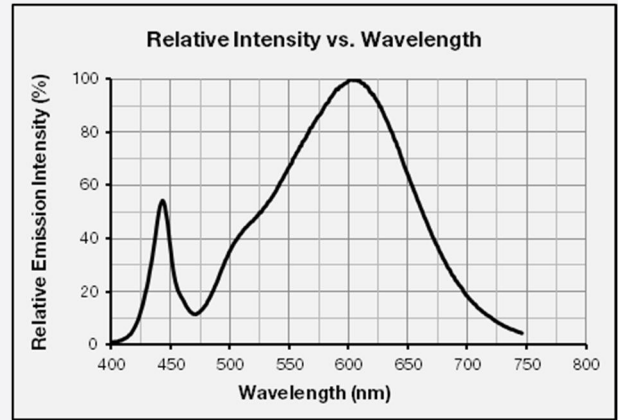

CCT: 3500 K (80 CRI)

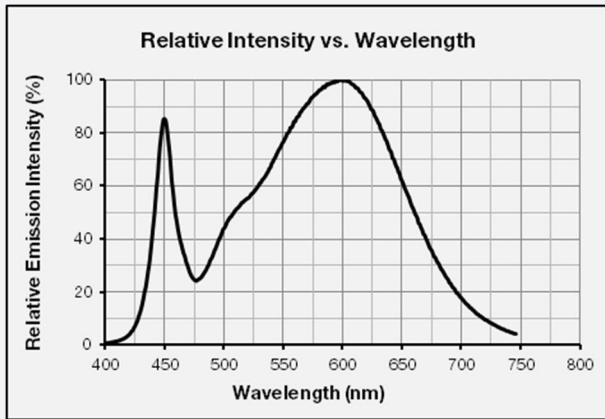

CCT: 4000 K (80 CRI)

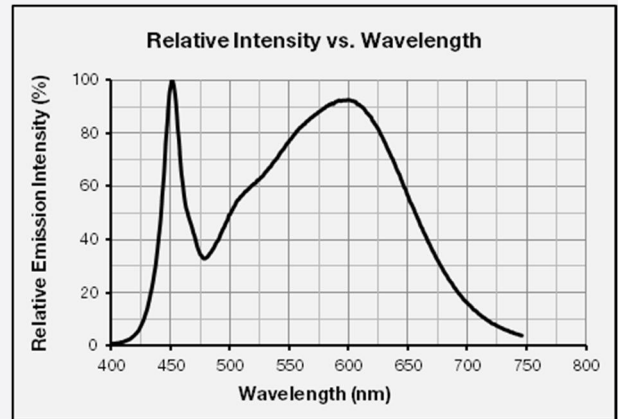

CCT: 5000 K (80 CRI)

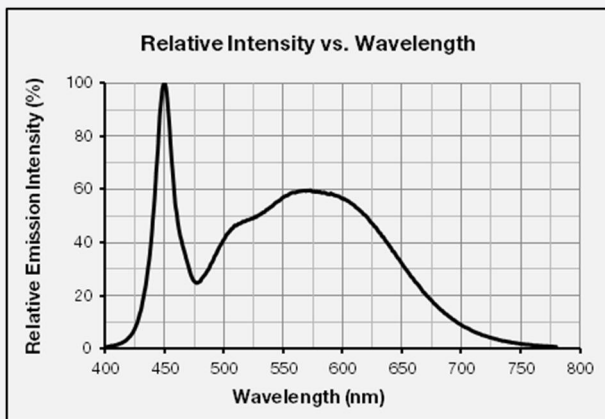

CCT: 5700 K (80 CRI)

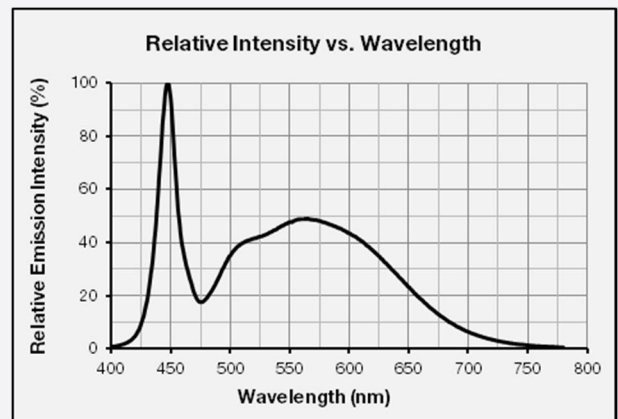

CCT: 2700 K (90 CRI)

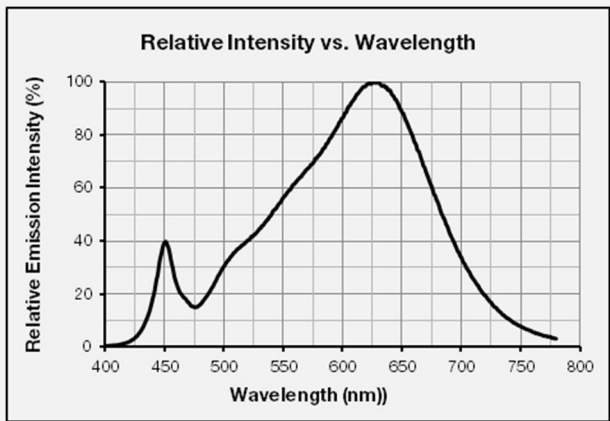

CCT: 3000 K (90 CRI)

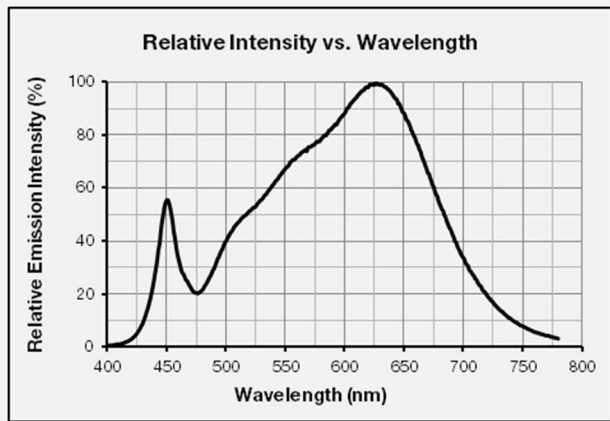

CCT: 3500 K (90 CRI)

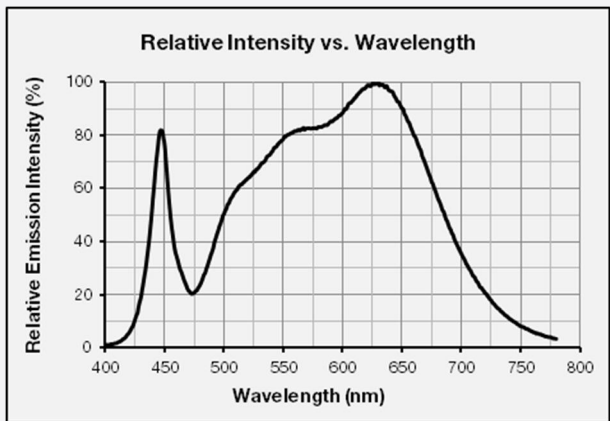

CCT: 4000 K (90 CRI)

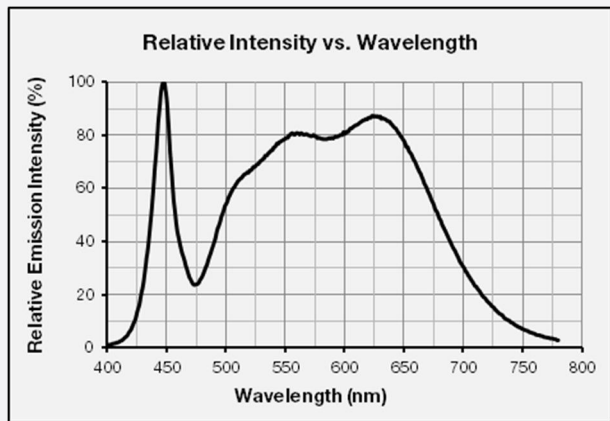

b) Forward Current Characteristics (T_a = 25 °C)

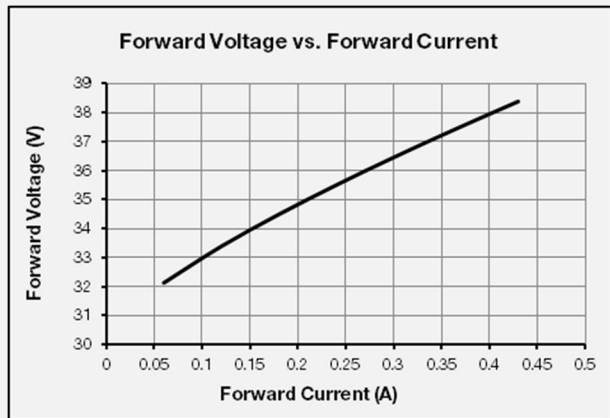
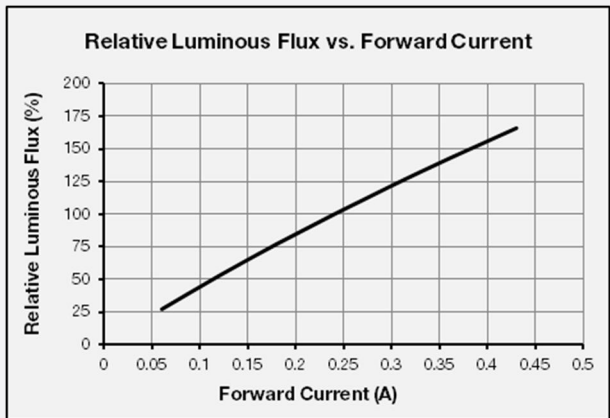

c) Temperature Characteristics ($I_F = 240 \text{ mA}$)

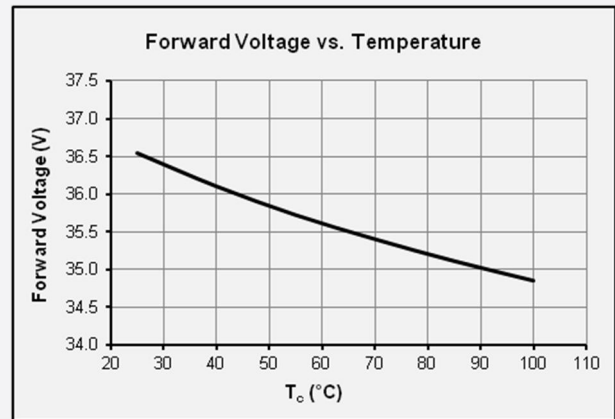
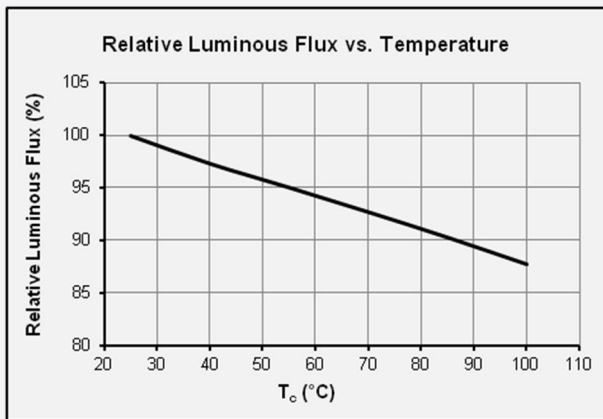

d) Color Shift Characteristics

$T_a = 25 \text{ °C}$

$I_F = 240 \text{ mA}$

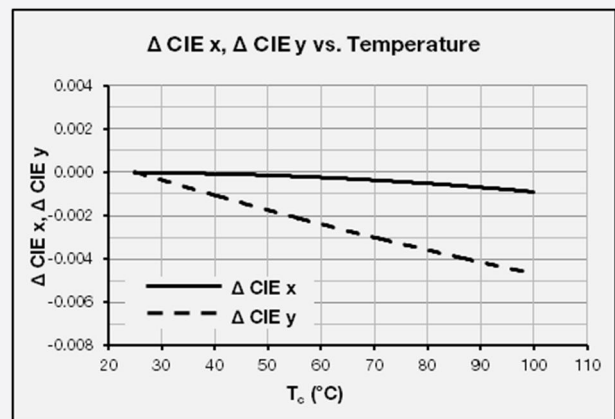
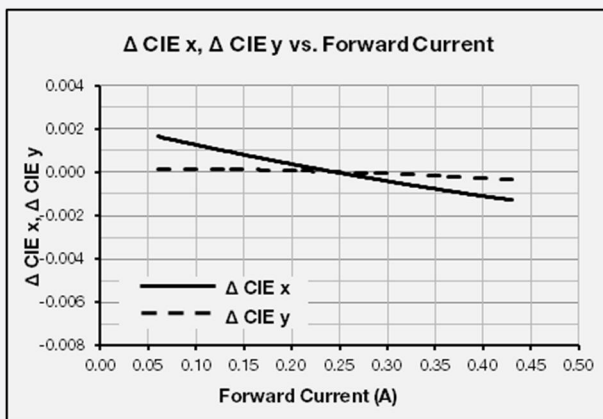

e) Derating Curve

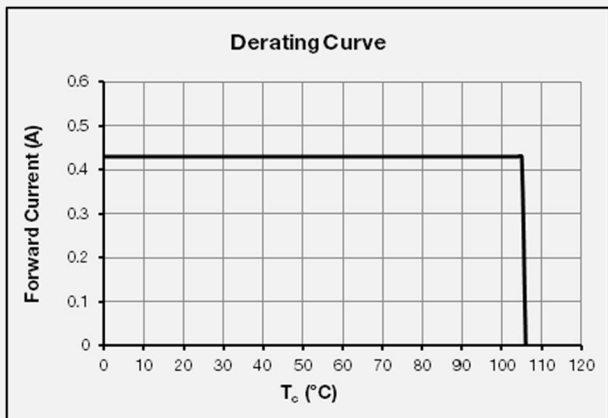

f) Beam Angle Characteristics (I_F = 240 mA, T_a = 25 °C)

80 CRI

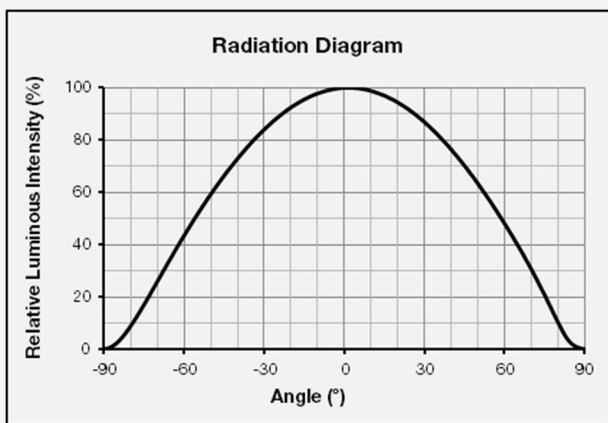

90 CRI

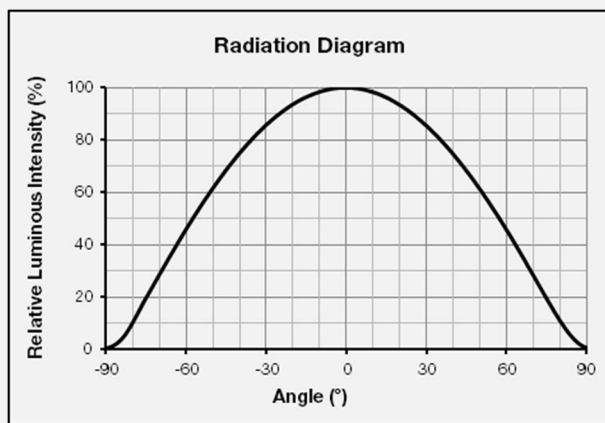

4. Outline Drawing & Dimension

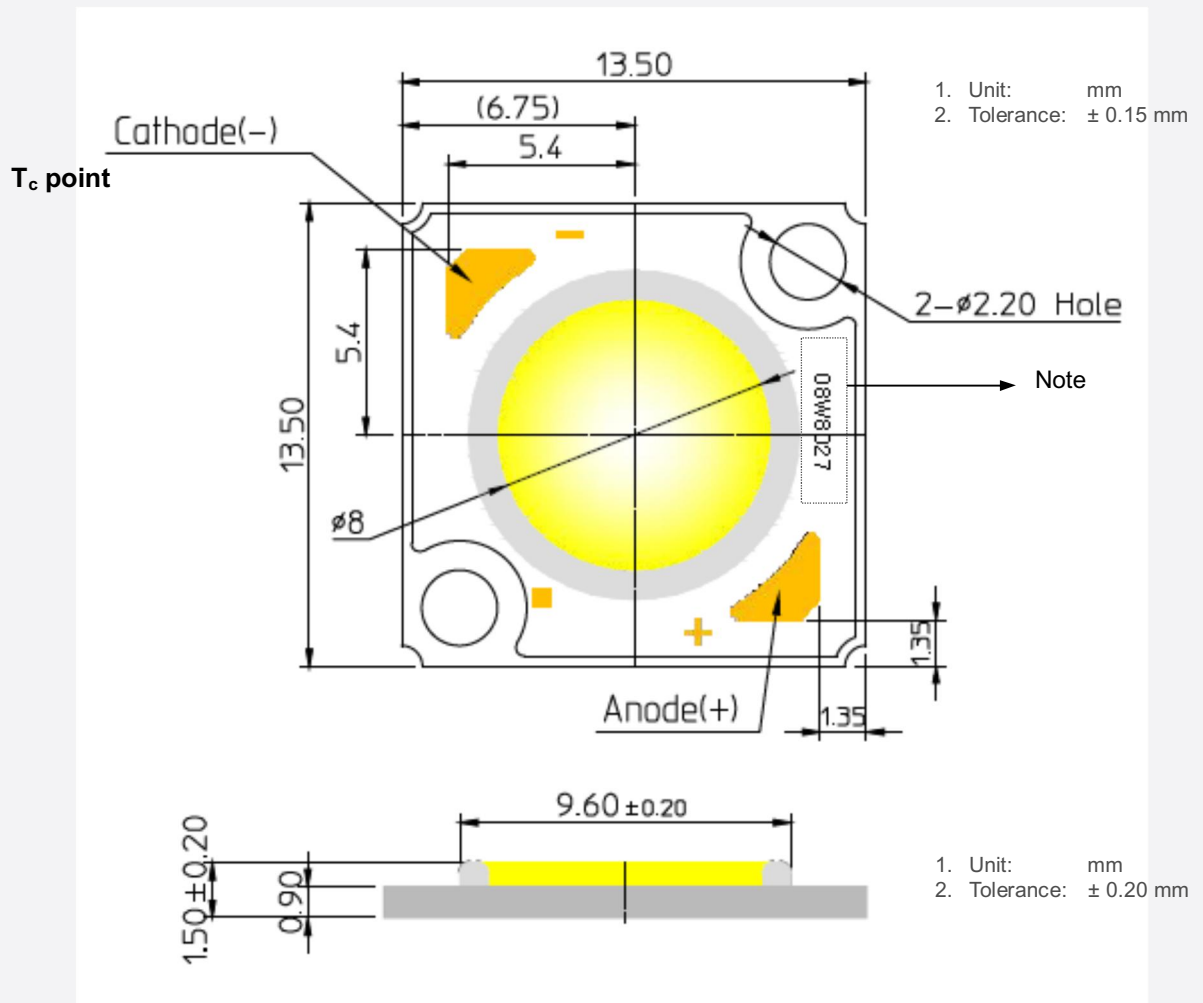

Item	Dimension	Tolerance	Unit
Length	13.50	±0.15	mm
Width	13.50	±0.15	mm
Height	1.50	±0.20	mm
Light Emitting Surface (LES) Diameter	8	±0.15	mm
Screw Hole Size	2.2	±0.15	mm

Note: Denoted product information above is only an example
(08W8027 : 8.6W, CRI80+, 2700K)

5. Reliability Test Items & Conditions

a) Test Items

Test Item	Test Condition	Test Hour / Cycle
Room Temperature Life Test	25 °C, I _F = max	1000 h
High Temperature Humidity Life Test	60 °C, 90 % RH, DC Derating, I _F = max	1000 h
High Temperature Life Test	105 °C, DC Derating, I _F = max	1000 h
Low Temperature Life Test	-40 °C, DC 430 mA	1000 h
High Temperature Storage	120 °C	1000 h
Low Temperature Storage	-40 °C	1000 h
Thermal Shock	-45 °C / 15 min ↔ 125 °C / 15 min temperature change in 5 min	200 cycles
Temperature Cycle On/Off Test	-40 °C / 85 °C each 20 min, 100 min transfer power on/off each 5 min, DC 240 mA	100 cycles
ESD (HBM)	R ₁ : 10 MΩ R ₂ : 1.5 kΩ C: 100 pF V: ±2 kV	5 times
ESD (MM)	R ₁ : 10 MΩ R ₂ : 0 kΩ C: 200 pF V: ±0.5 kV	5 times
Vibration Test	20 ~ 80 Hz (displacement: 0.06 inch, max. 20 g) 80 ~ 2 kHz (max. 20 g) min. frequency ↔ max. frequency 4 min transfer	4 times
Mechanical Shock Test	1500 g, 0.5 ms each of the 6 surfaces (3 axis x 2 sides)	5 times
Salt Spray Test	35 °C, 5 % salt water 8 h spray, 16 h dwell	2 cycles

b) Criteria for Judging the Damage

Item	Symbol	Test Condition (T _c = 25 °C)	Limit	
			Min.	Max.
Forward Voltage	V _F	I _F = 240 mA	L.S.L. * 0.9	U.S.L. * 1.1
Luminous Flux	Φ _v	I _F = 240 mA	L.S.L. * 0.7	U.S.L. * 1.3

6. Label Structure

a) Label Structure

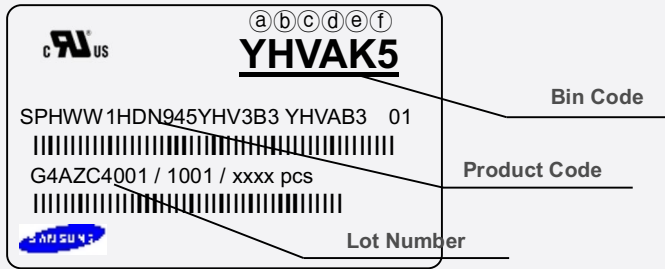

Note: Denoted bin code and product code above is only an example (see description on page 5)

Bin Code:

- ⒶⒷ: Forward Voltage bin (refer to page 11)
- ⒸⒹ: Chromaticity bin (refer to page 9-10)
- ⒺⒻ: Luminous Flux bin (refer to page 6)

b) Lot Number

The lot number is composed of the following characters:



① ③④⑤⑥⑦⑧⑨ / 1ⒶⒷⒸ / xxxx pcs

- ① : Production site (S: Giheung, Korea, G: Tianjin, China)
- ② : 4 (LED)
- ③ : Product state (A: Normal, B: Bulk, C: First Production, R: Reproduction, S: Sample)
- ④ : Year (Z: 2015, A: 2016, B: 2017...)
- ⑤ : Month (1~9, A, B, C)
- ⑥⑦⑧⑨ : Day (1~9, A, B~V)
- ⒶⒷⒸ : Product serial number (001 ~ 999)

7. Packing Structure

Packing material	Max. quantity in pcs of COB	Dimension (mm)			
		Length	Width	Height	Tolerance
Tray	50	260	190	11.5	1.0
Anti-static Bag	250 (6 trays)	387	350	-	10.0
Box	1,750 (7 anti-static bag)	-	-	-	-

a) Packing Structure

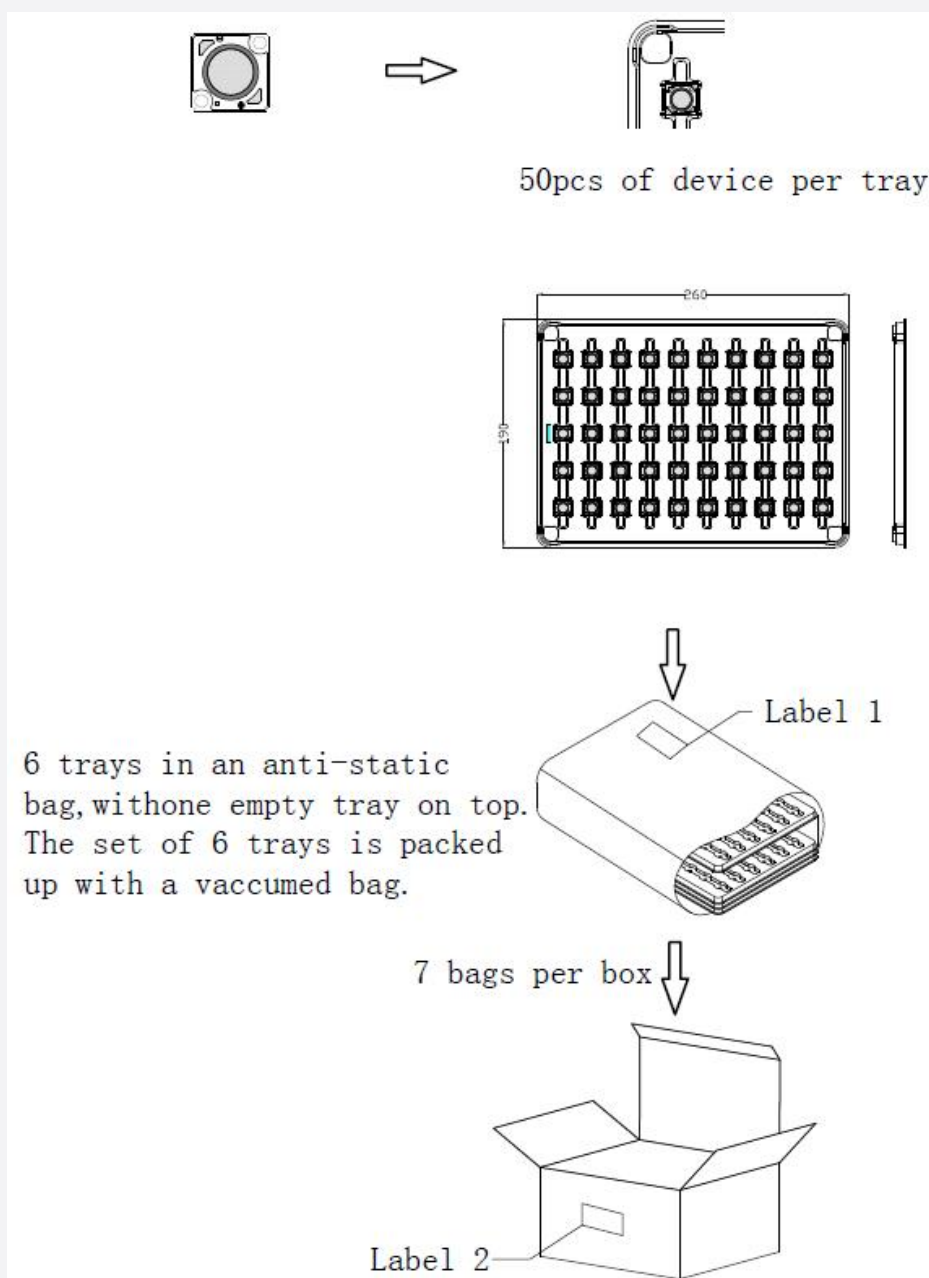

b) Tray

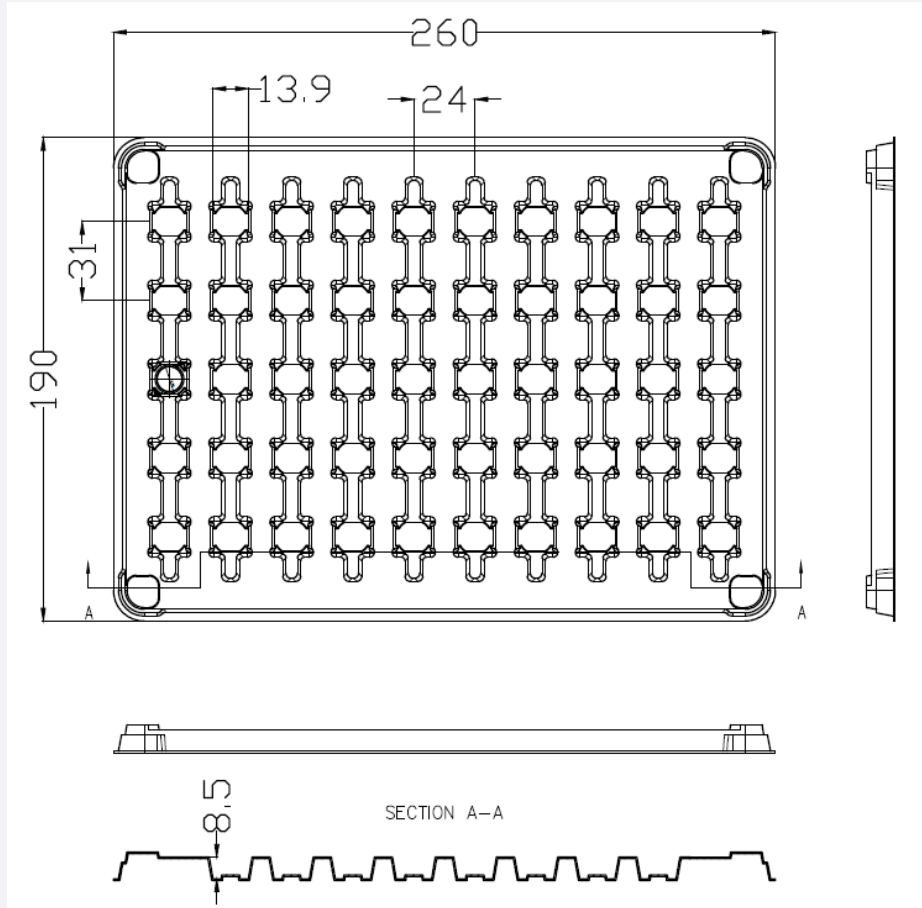

c) Anti-static Bag

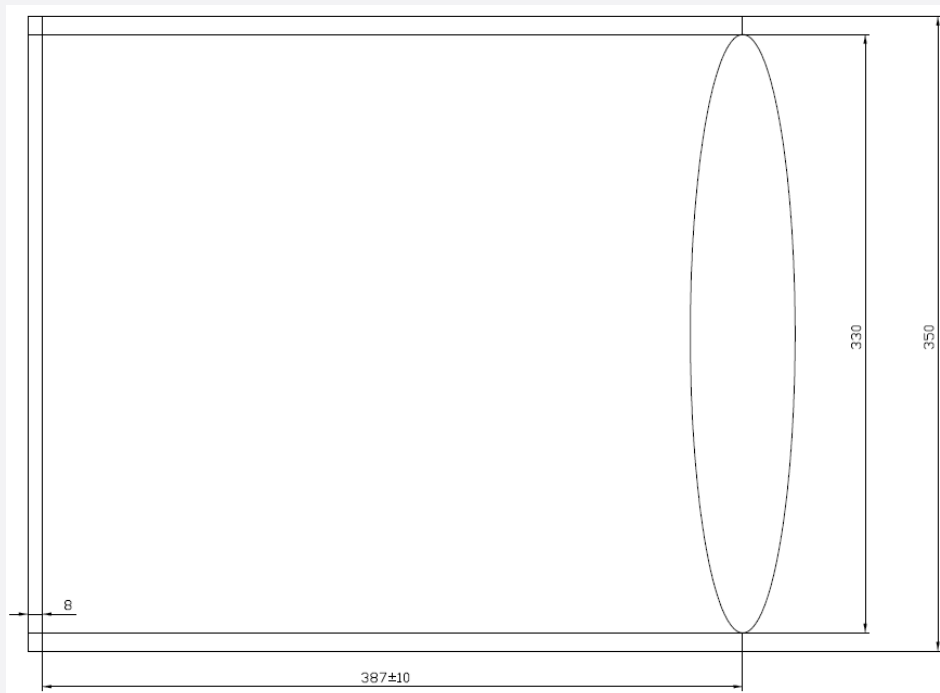

8. Precautions in Handling & Use

- 1) This device should not be used in any type of fluid such as water, oil, organic solvent, etc. When cleaning is required, IPA is recommended as the cleaning agent. Some solvent-based cleaning agent may damage the silicone resins used in the device.
- 2) LEDs must be stored in a clean environment. If the LEDs are to be stored for three months or more after being shipped from Samsung, they should be packed with a nitrogen-filled container (shelf life of sealed bags is 12 months at temperature 0~40 °C, 0~90 % RH).
- 3) After storage bag is opened, device subjected to soldering, solder reflow, or other high temperature processes must be:
 - a. Mounted within 672 hours (28 days) at an assembly line with a condition of no more than 30 °C / 60 % RH, or
 - b. Stored at <10 % RH
- 4) Repack unused products with anti-moisture packing, fold to close any opening and then store in a dry place.
- 5) Devices require baking before mounting, if humidity card reading is >60 % at 23 ± 5 °C.
- 6) Devices must be baked for 1 hour at 60 ± 5 °C, if baking is required.
- 7) The LEDs are sensitive to the static electricity and surge current. It is recommended to use a wrist band or anti-electrostatic glove when handling the LEDs. If voltage exceeding the absolute maximum rating is applied to LEDs, it may cause damage or even destruction to LED devices. Damaged LEDs may show some unusual characteristics such as increase in leakage current, lowered turn-on voltage, or abnormal lighting of LEDs at low current.
- 8) In case of driving the LC008B around the extremely low current level, chips might exhibit different brightness due to the variation in I-V characteristics of each one. This is normal and does not adversely affect the performance of product.
- 9) VOCs (Volatile Organic Compounds) can be generated from adhesives, flux, hardener or organic additives used in luminaires (fixtures). Transparent LED silicone encapsulant is permeable to those chemicals and they may lead to a discoloration of encapsulant when they exposed to heat or light. This phenomenon can cause a significant loss of light emitted (output) from the luminaires. In order to prevent these problems, we recommend users to know the physical properties of materials used in luminaires and they must be carefully selected.
- 10) The resin area is very sensitive, please do not handle, press, touch, rub, clean, or pick by with tweezers on it. Instead, please pick at the handling area as indicated below.

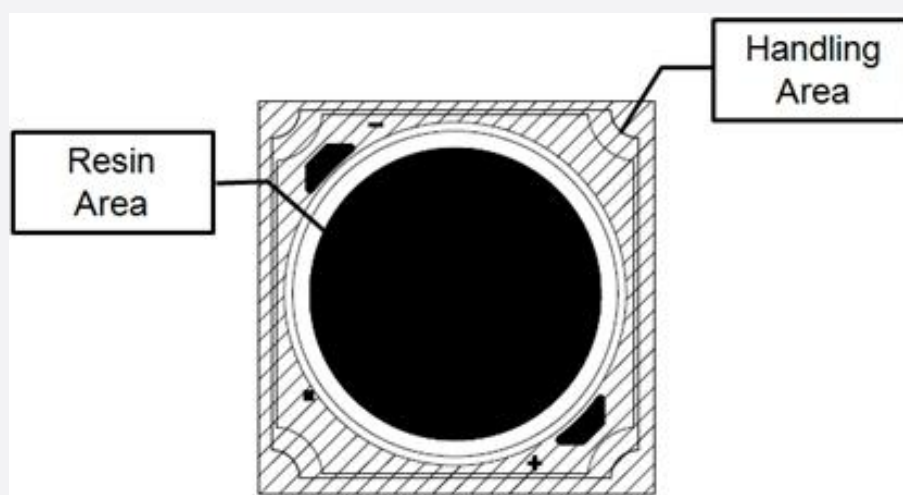

Legal and additional information.

[About Samsung Electronics Co., Ltd.](#)

Samsung Electronics Co., Ltd. inspires the world and shapes the future with transformative ideas and technologies, redefining the worlds of TVs, smartphones, wearable devices, tablets, cameras, digital appliances, printers, medical equipment, network systems and semiconductors.

We are also leading in the Internet of Things space through, among others, our Digital Health and Smart Home initiatives. We employ 307,000 people across 84 countries. To discover more, please visit our official website at www.samsung.com and our official blog at global.samsungtomorrow.com.

Copyright © 2015 Samsung Electronics Co., Ltd. All rights reserved.

Samsung is a registered trademark of Samsung Electronics Co., Ltd.

Specifications and designs are subject to change without notice. Non-metric weights and measurements are approximate. All data were deemed correct at time of creation. Samsung is not liable for errors or omissions. All brand, product, service names and logos are trademarks and/or registered trademarks of their respective owners and are hereby recognized and acknowledged.

Samsung Electronics Co., Ltd.

95, Samsung 2-ro

Giheung-gu

Yongin-si, Gyeonggi-do, 446-711



KOREA

www.samsungled.com









Looking for pricing, stock, or lifecycle information?

Click below to explore more details on WIN SOURCE:

-  [View SPHCW1HDN945YHQT B3 on WIN SOURCE](#)
-  [Samsung Information](#)

Optimize Your Supply Chain with WIN SOURCE Solutions

-  Global Sourcing Solution
-  Obsolete Management
-  Cost Control Management
-  Shortage Management
-  Alternative Solution
-  Excess Inventory Management