



**THE DATASHEET OF  
SPHCW1HDNA25YHRTB3**



High Power LED Series  
Chip on Board

# LC013B - Gen3



High efficacy COB LED package,  
well-suited for use in spotlight applications

## Features & Benefits

- Chip on Board (COB) solution makes it easy to design in
- Simple assembly reduces manufacturing cost
- Low thermal resistance
- InGaN/GaN MQW LED with long time reliability
- Completed 6,000 hours of LM-80 Testing

## Applications

- Spotlight / Downlight
- LED Retrofit Bulbs
- Outdoor Illumination



## Table of Contents

1.	Characteristics	-----	3
2.	Product Code Information	-----	5
3.	Typical Characteristics Graphs	-----	10
4.	Outline Drawing & Dimension	-----	15
5.	Reliability Test Items & Conditions	-----	16
6.	Label Structure	-----	17
7.	Packing Structure	-----	18
8.	Precautions in Handling & Use	-----	20

## 1. Characteristics

### a) Absolute Maximum Rating

Item	Symbol	Rating	Unit	Condition
Ambient / Operating Temperature	$T_a$	-40 ~ +105	°C	-
Storage Temperature	$T_{stg}$	-40 ~ +120	°C	-
LED Junction Temperature	$T_j$	150	°C	-
Case Temperature	$T_c$	105	°C	*Note
Forward Current	$I_F$	660	mA	-
Power Dissipation	$P_D$	24.4	W	-
ESD (HBM)	-	±2	kV	-
ESD (MM)	-	±0.5	kV	-

### b) Electro-optical Characteristics ( $I_F = 360 \text{ mA}$ , $T_a = 25 \text{ °C}$ )

Item	Unit	Rank	Min.	Typ.	Max.
Forward Voltage ( $V_F$ )	V	YH	32.5	35.5	38.5
Color Rendering Index ( $R_a$ )	-	5	80	-	-
		7	90	-	-
Thermal Resistance (junction to chip point)	°C/W		-	1.6	-
Beam Angle	°		-	115	-
Nominal Power	W			12.8	
Eye Protection		Risk 1	-		-

#### Notes:

- 1) The COB is tested in pulsed condition at rated test current (10 ms pulse width) and rated temperature ( $T_j = T_c = T_a = 25 \text{ °C}$ )
- 2) Samsung maintains measurement tolerance of: forward voltage = ±5 %, CRI = ±1
- 3) Refer to the derating curve, '3. Typical Characteristics Graph' designed within the range.

c) Luminous Flux Characteristics (I<sub>F</sub> = 360 mA)

CRI (R <sub>a</sub> )	Nominal CCT (K)	Flux Rank	Flux Bin	Sorting <sup>1)</sup> @ T <sub>c</sub> = 25 °C (lm)		Calculated Flux <sup>2)</sup> @ T <sub>c</sub> = 85 °C (lm)	
				Min.	Max.	Min.	Max.
80	2700	B3	18	1800	1900	1638	1729
			19	1900	2000	1729	1820
			20	2000	2138	1820	1946
	3000	B3	18	1850	1950	1684	1775
			19	1950	2050	1775	1866
			20	2050	2189	1866	1992
	3500	B3	19	1950	2060	1775	1875
			20	2060	2209	1875	2010
	4000	B3	19	1870	1980	1702	1802
			20	1980	2090	1802	1902
			21	2090	2240	1902	2038
	5000	B3	18	1800	1920	1638	1747
19			1920	2040	1747	1856	
20			2040	2199	1856	2001	
5700	B3	18	1800	1920	1638	1747	
		19	1920	2040	1747	1856	
		20	2040	2199	1856	2001	
90	2700	B3	14	1405	1520	1279	1383
			15	1520	1670	1383	1520
			16	1670	1822	1520	1658
	3000	B3	14	1440	1560	1310	1420
			15	1560	1710	1420	1556
			16	1710	1863	1556	1695
	3500	B3	14	1475	1595	1342	1451
			15	1595	1745	1451	1588
	4000	B3	16	1745	1904	1588	1733
			14	1520	1645	1383	1497
			15	1645	1795	1497	1633
				16	1795	1955	1633

**Notes:**

- 1) The COB is tested in pulsed condition at rated test current (10 ms pulse width) and rated temperature (T<sub>j</sub> = T<sub>c</sub> = T<sub>a</sub> = 25 °C)
- 2) Calculated flux values are for reference only
- 3) Samsung maintains measurement tolerance of: luminous flux = ±7 %, CRI = ±1



## 2. Product Code Information

1	2	3	4	5	6	7	8	9	10	11	12	13	14	15	16	17	18
S	P	H	C	W	1	H	D	N	A	2	5	Y	H	R	T	B	3

Digit	PKG Information	Code	Specification				
1 2 3	Samsung Package High Power	<b>SPH</b>					
4 5	Color	<b>WW</b> <b>CW</b>	Warm White (T/U/V/W Ranks) Cool White (Q/R Ranks)				
6	Product Version	<b>1</b>					
7 8	Form Factor	<b>HD</b>	COB				
9	Lens Type	<b>N</b>	No lens				
10	Internal Code	<b>A</b>	LC013				
11	Chip Type	<b>2</b>					
12	CRI & Sorting Temperature	<b>5</b> <b>7</b>	Min. 80 25 °C Min. 90				
13 14	Forward Voltage (V)	<b>YH</b>	32.5~38.5				
15	CCT (K)	<b>W</b> <b>V</b> <b>U</b> <b>T</b> <b>R</b> <b>Q</b>	2700 K 3000 K 3500 K 4000 K 5000 K 5700 K	WA, WB VA, VB UA, UB TA, TB RA	(MacAdam Ellipse) (MacAdam Ellipse) (MacAdam Ellipse) (MacAdam Ellipse) (MacAdam Ellipse)	VW, VX, VY, VZ (ANSI bin) TW, TX, TY, TZ (ANSI bin) RW, RX, RY, RZ (ANSI bin) QW, QX, QY, QZ (ANSI bin)	
16	MacAdam / ANSI	<b>2</b> <b>3</b> <b>T</b>	MacAdam 2-step MacAdam 3-step ANSI bin				
17 18	Luminous Flux	<b>B3</b>	Bin Code: 18, 19, 20 (80 CRI) 14, 15, 16 (90 CRI)				

a) Binning Structure (I<sub>F</sub> = 360 mA, T<sub>c</sub> = 25 °C)

CRI (R <sub>a</sub> ) Min.	Nominal CCT (K)	Product Code	V <sub>F</sub> Rank	Color Rank	Chrom. Bin	Flux Rank	Flux Bin	Flux Range (Φ <sub>v</sub> , lm)		
80	2700	SPHWW1HDNA25YHW2B3	YH	W2	WB	B3	18	1800 ~ 1900		
							19	1900 ~ 2000		
							20	2000 ~ 2138		
		SPHWW1HDNA25YHW3B3	YH	W3	WA, WB	B3	B3	18	1800 ~ 1900	
								19	1900 ~ 2000	
								20	2000 ~ 2138	
	3000	SPHWW1HDNA25YHV2B3	YH	V2	VB	B3	B3	18	1850 ~ 1950	
								19	1950 ~ 2050	
								20	2050 ~ 2189	
		SPHWW1HDNA25YHV3B3	YH	V3	VA, VB	B3	B3	B3	18	1850 ~ 1950
									19	1950 ~ 2050
									20	2050 ~ 2189
	3500	SPHWW1HDNA25YHU2B3	YH	U2	UB	B3	B3	19	1950 ~ 2060	
								20	2060 ~ 2209	
								20	2060 ~ 2209	
		SPHWW1HDNA25YHU3B3	YH	U3	UA, UB	B3	B3	B3	19	1950 ~ 2060
									20	2060 ~ 2209
									20	2060 ~ 2209
	4000	SPHWW1HDNA25YHT2B3	YH	T2	TB	B3	B3	18	1870 ~ 1980	
								19	1980 ~ 2090	
								20	2090 ~ 2240	
		SPHWW1HDNA25YHT3B3	YH	T3	TA, TB	B3	B3	B3	18	1870 ~ 1980
									19	1980 ~ 2090
									20	2090 ~ 2240
5000	SPHCW1HDNA25YHR3B3	YH	R3	RA	B3	B3	18	1800 ~ 1920		
							19	1920 ~ 2040		
							20	2040 ~ 2199		
	SPHCW1HDNA25YHRTB3	YH	RT	RW, RX, RY, RZ	B3	B3	B3	18	1800 ~ 1920	
								19	1920 ~ 2040	
								20	2040 ~ 2199	
5700	SPHCW1HDNA25YHQT3B3	YH	QT	QW, QX, QY, QZ	B3	B3	18	1800 ~ 1920		
							19	1920 ~ 2040		
							20	2040 ~ 2199		

a) Binning Structure ( $I_F = 360 \text{ mA}$ ,  $T_c = 25 \text{ }^\circ\text{C}$ )

CRI ( $R_a$ ) Min.	Nominal CCT (K)	Product Code	$V_F$ Rank	Color Rank	Chrom. Bin	Flux Rank	Flux Bin	Flux Range ( $\Phi_v$ , lm)
90	2700	SPHWW1HDNA27YHW3B3	YH	W2	WB	B3	14	1405 ~ 1520
							15	1520 ~ 1670
							16	1670 ~ 1822
		SPHWW1HDNA27YHW2B3	YH	W3	WA, WB	B3	14	1405 ~ 1520
							15	1520 ~ 1670
							16	1670 ~ 1822
	3000	SPHWW1HDNA27YHV2B3	YH	V2	VB	B3	14	1440 ~ 1560
							15	1560 ~ 1710
							16	1710 ~ 1863
		SPHWW1HDNA27YHV3B3	YH	V3	VA, VB	B3	14	1440 ~ 1560
							15	1560 ~ 1710
							16	1710 ~ 1863
	3500	SPHWW1HDNA27YHU2B3	YH	U2	UB	B3	14	1475 ~ 1595
							15	1595 ~ 1745
							16	1745 ~ 1904
		SPHWW1HDNA27YHU3B3	YH	U3	UA, UB	B3	14	1475 ~ 1595
							15	1595 ~ 1745
							16	1745 ~ 1904
	4000	SPHWW1HDNA27YHT2B3	YH	T2	TB	B3	14	1520 ~ 1645
							15	1645 ~ 1795
							16	1795 ~ 1955
		SPHWW1HDNA27YHT3B3	YH	T3	TA, TB	B3	14	1520 ~ 1645
							15	1645 ~ 1795
							16	1795 ~ 1955

b) Chromaticity Region & Coordinates ( $I_f = 360 \text{ mA}$ ,  $T_a = 25 \text{ }^\circ\text{C}$ )

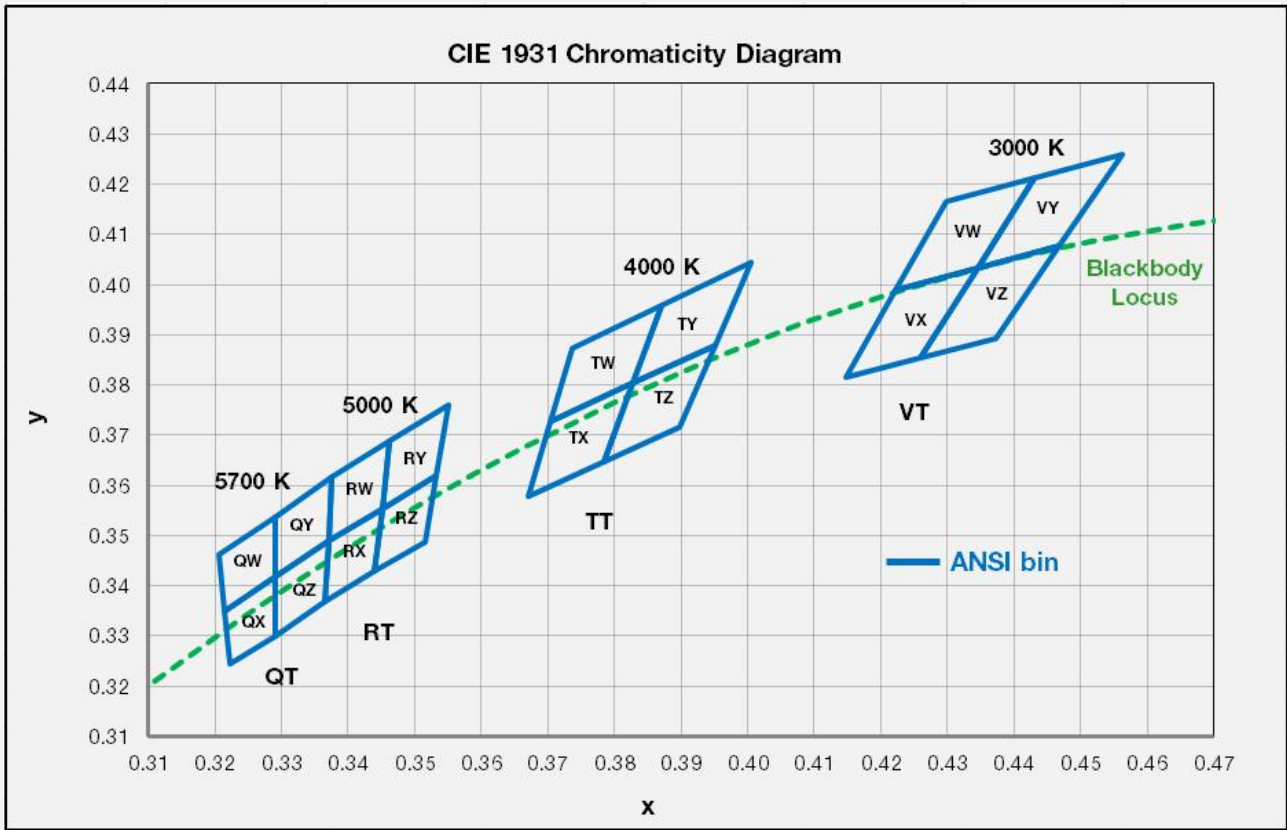

Region	CIE x	CIE y	Region	CIE x	CIE y
<b>V rank (3000 K)</b>					
VW	0.4223	0.399	VY	0.4345	0.4033
	0.4345	0.4033		0.4468	0.4077
	0.4431	0.4213		0.4562	0.4260
	0.4299	0.4165		0.4431	0.4213
VX	0.4223	0.399	VZ	0.4260	0.3854
	0.4147	0.3814		0.4373	0.3893
	0.4260	0.3854		0.4468	0.4077
	0.4345	0.4033		0.4345	0.4033
<b>R rank (5000 K)</b>					
RW	0.3376	0.3616	RY	0.3463	0.3687
	0.3463	0.3687		0.3551	0.3760
	0.3451	0.3554		0.3533	0.3620
	0.3371	0.3490		0.3451	0.3554
RX	0.3371	0.3490	RZ	0.3451	0.3554
	0.3451	0.3554		0.3533	0.3620
	0.3440	0.3428		0.3515	0.3487
	0.3366	0.3369		0.3440	0.3428

Region	CIE x	CIE y	Region	CIE x	CIE y
<b>T rank (4000 K)</b>					
TW	0.3736	0.3874	TY	0.3871	0.3959
	0.3871	0.3959		0.4006	0.4044
	0.3828	0.3803		0.3952	0.388
	0.3703	0.3726		0.3828	0.3803
TX	0.3703	0.3726	TZ	0.3828	0.3803
	0.3828	0.3803		0.3952	0.388
	0.3784	0.3647		0.3898	0.3716
	0.367	0.3578		0.3784	0.3647
<b>Q rank (5700 K)</b>					
QW	0.3207	0.3462	QY	0.3290	0.3538
	0.3290	0.3538		0.3376	0.3616
	0.3290	0.3417		0.3371	0.3490
	0.3215	0.3350		0.3290	0.3417
QX	0.3215	0.3350	QZ	0.3290	0.3417
	0.3290	0.3417		0.3371	0.3490
	0.3290	0.3300		0.3366	0.3369
	0.3222	0.3243		0.3290	0.3300

b) Chromaticity Region & Coordinates ( $I_F = 360 \text{ mA}$ ,  $T_c = 25 \text{ }^\circ\text{C}$ )

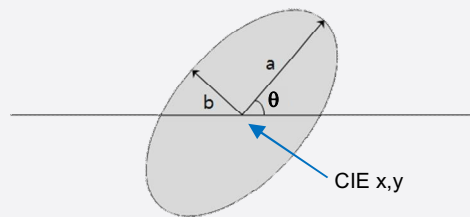
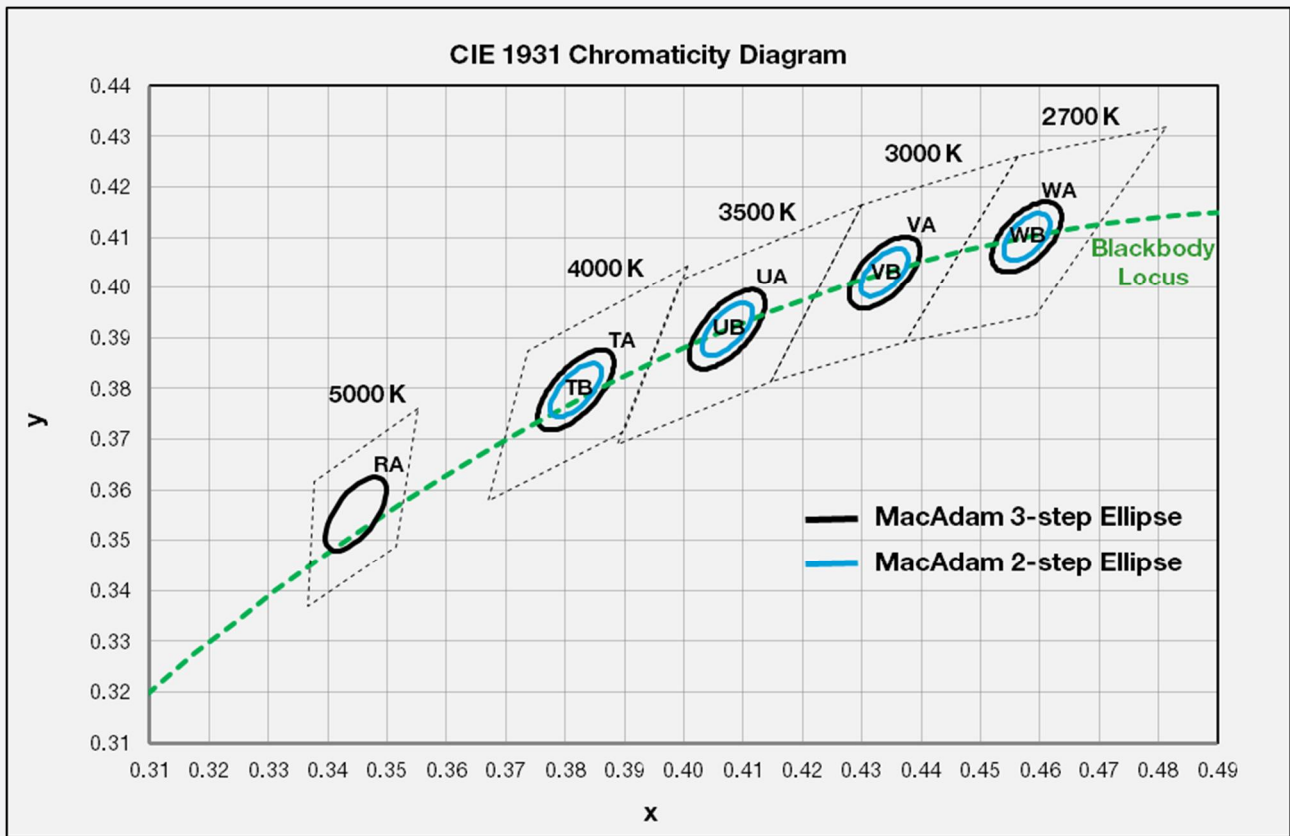

MacAdam Ellipse (WA, WB)					
Step	CIE x	CIE y	$\theta$	a	b
2-step	0.4578	0.4101	53.70	0.0054	0.0028
3-step	0.4578	0.4101	53.70	0.0081	0.0042

MacAdam Ellipse (VA, VB)					
Step	CIE x	CIE y	$\theta$	a	b
2-step	0.4338	0.403	53.22	0.0056	0.0027
3-step	0.4338	0.4030	53.22	0.0083	0.0041

MacAdam Ellipse (UA, UB)					
Step	CIE x	CIE y	$\theta$	a	b
2-step	0.4073	0.3917	54.00	0.0062	0.0028
3-step	0.4073	0.3917	54.00	0.0093	0.0041

MacAdam Ellipse (TA, TB)					
Step	CIE x	CIE y	$\theta$	a	b
2-step	0.3818	0.3797	53.72	0.0063	0.0027
3-step	0.3818	0.3797	53.72	0.0094	0.0040

MacAdam Ellipse (RA)					
Step	CIE x	CIE y	$\theta$	a	b
3-step	0.3447	0.3553	59.62	0.0082	0.0035

**Note:**

Samsung maintains measurement tolerance of:  $C_x, C_y = \pm 0.005$

### 3. Typical Characteristics Graphs

#### a) Spectrum Distribution ( $I_F = 360 \text{ mA}$ , $T_c = 25 \text{ }^\circ\text{C}$ )

CCT: 2700 K (80 CRI)

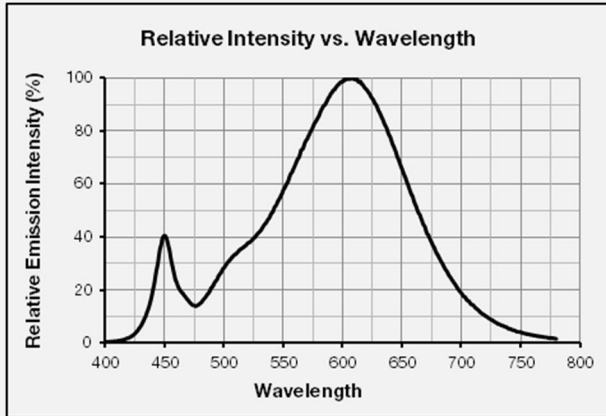

CCT: 3000 K (80 CRI)

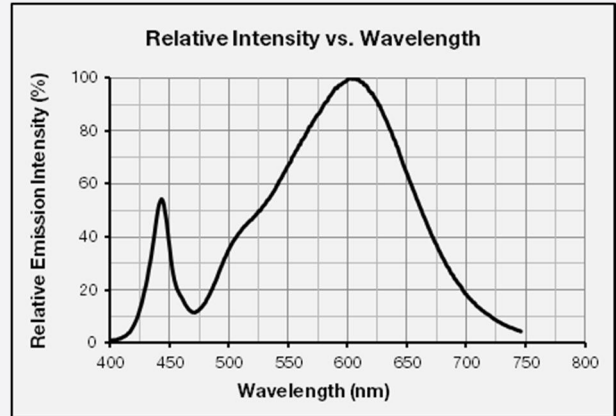

CCT: 3500 K (80 CRI)

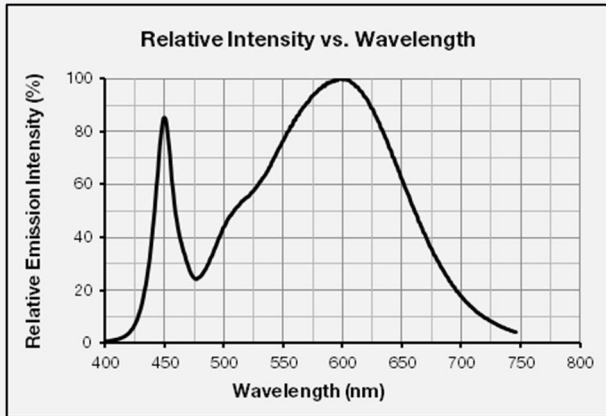

CCT: 4000 K (80 CRI)

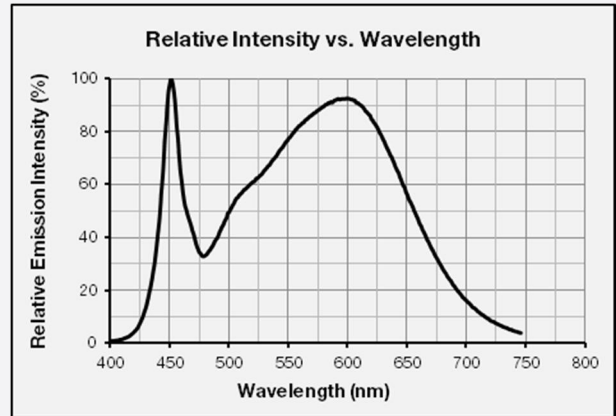

CCT: 5000 K (80 CRI)

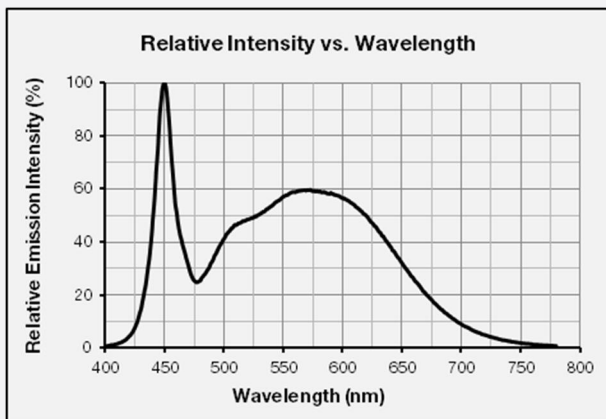

CCT: 5700 K (80 CRI)

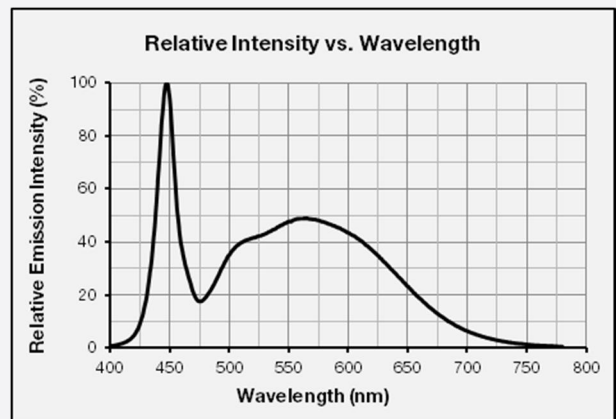

CCT: 2700 K (90 CRI)

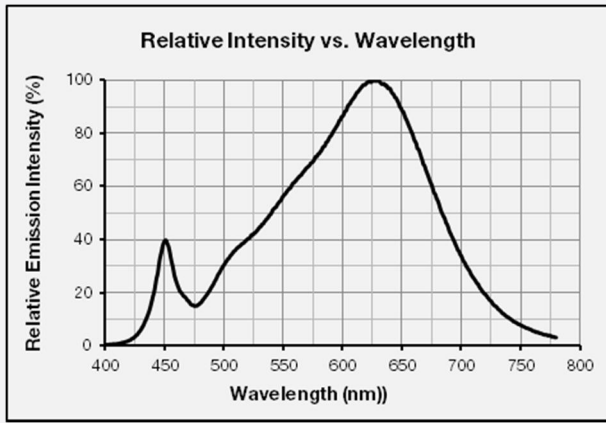

CCT: 3000 K (90 CRI)

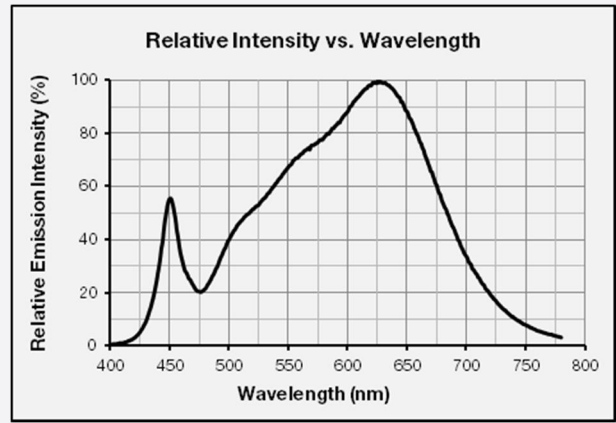

CCT: 3500 K (90 CRI)

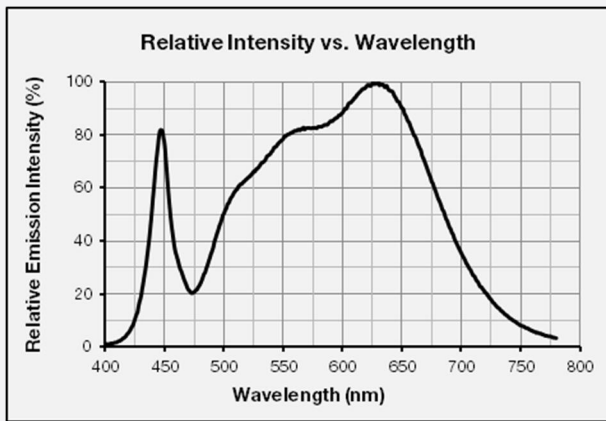

CCT: 4000 K (90 CRI)

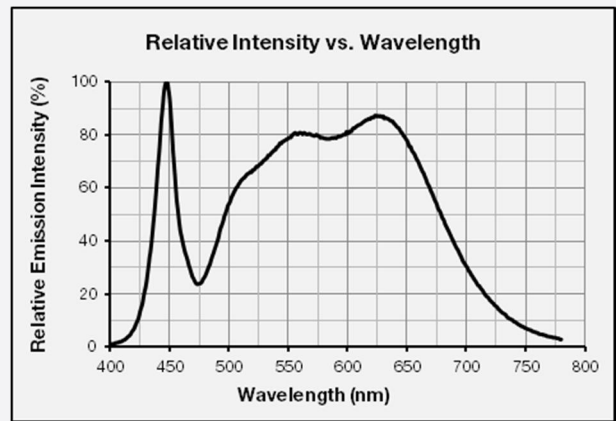

**b) Forward Current Characteristics (T<sub>a</sub> = 25 °C)**

80 CRI

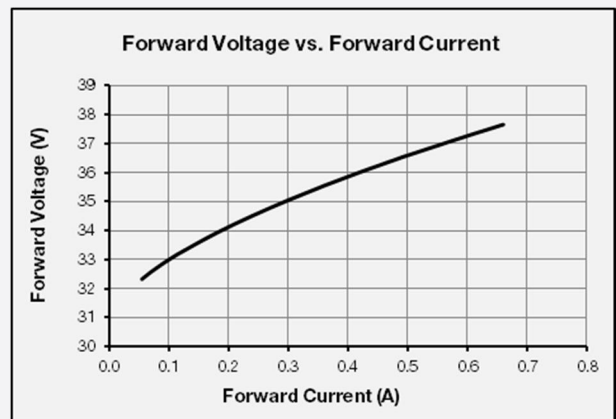
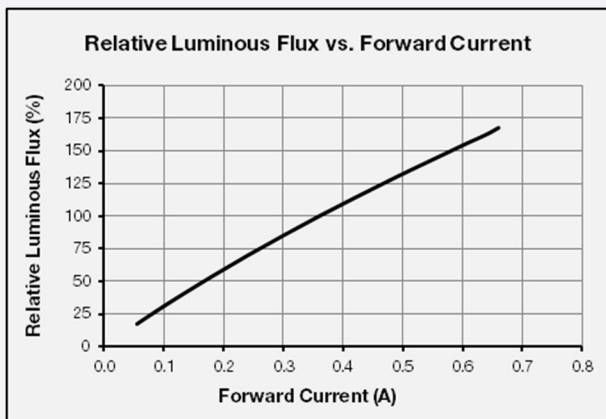

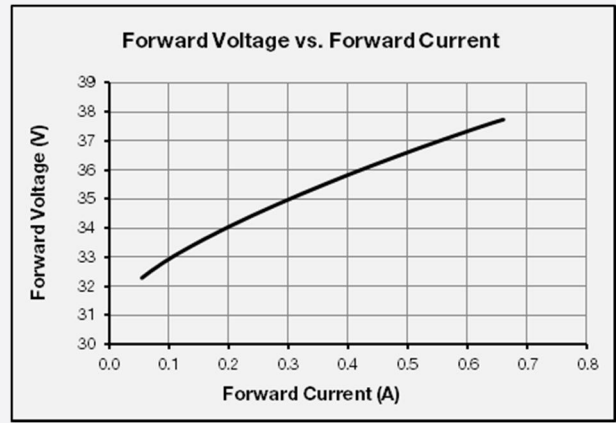
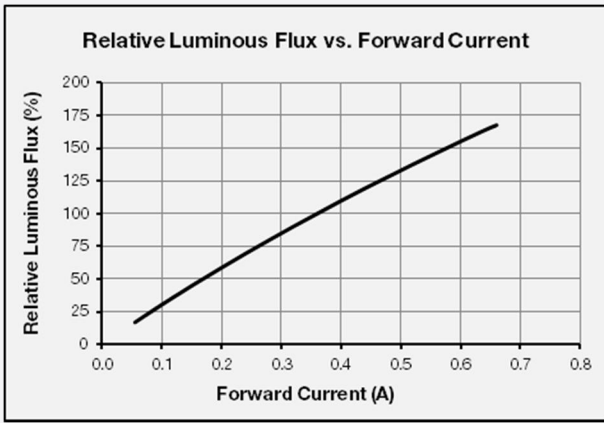

c) Temperature Characteristics ( $I_F = 360 \text{ mA}$ )

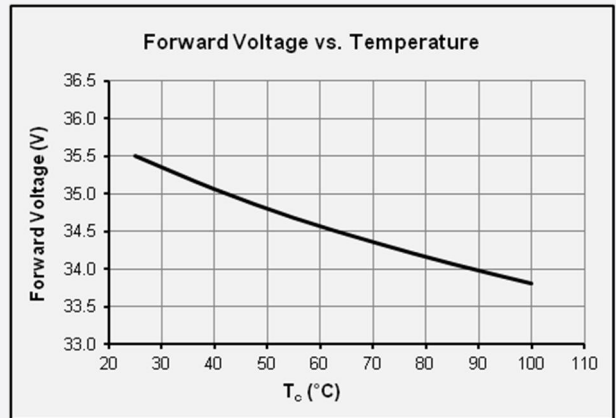
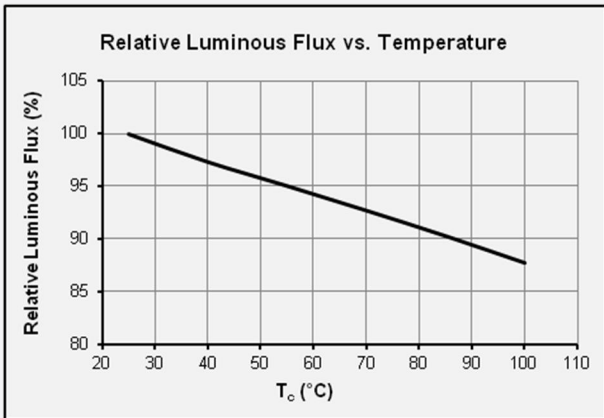
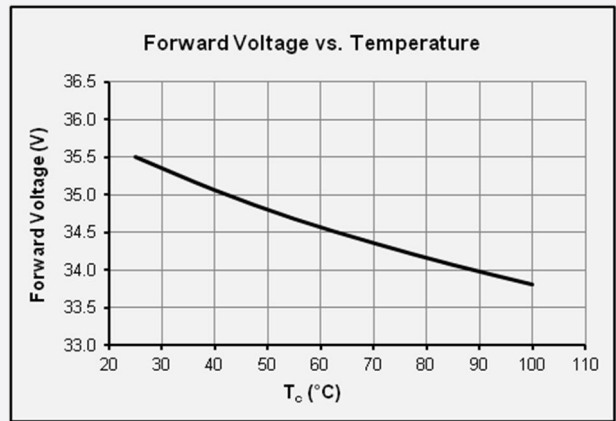
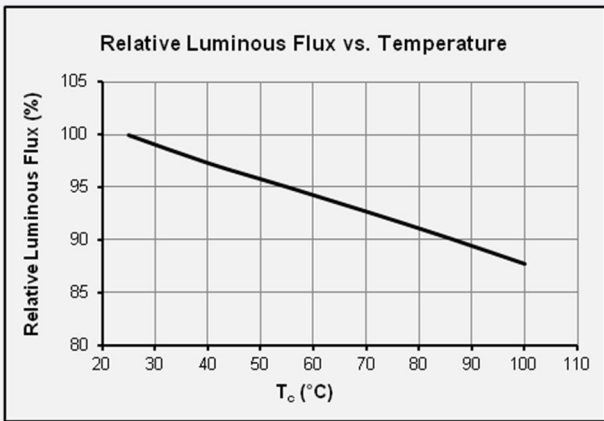

80 CRI

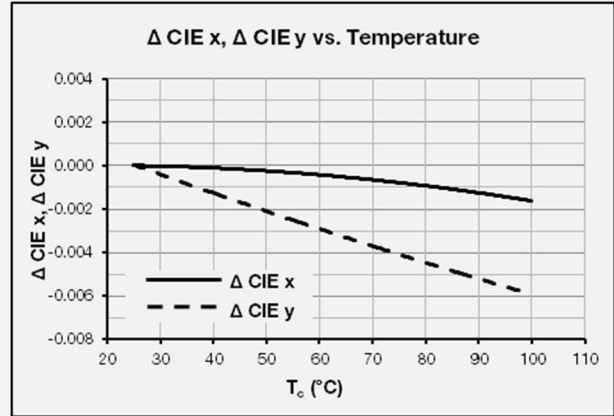
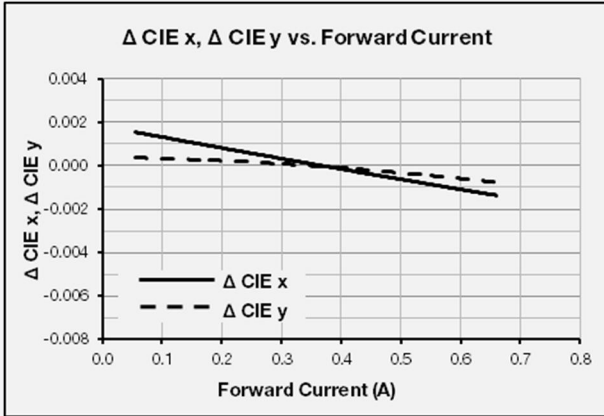

90 CRI

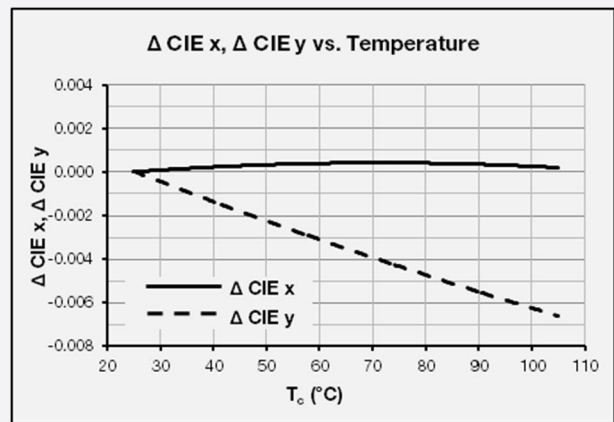
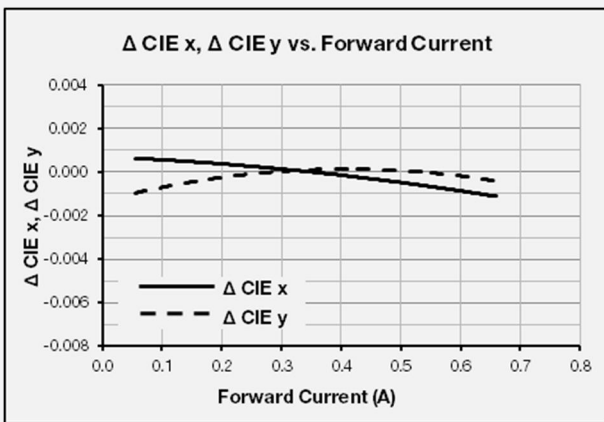

e) Derating Curve

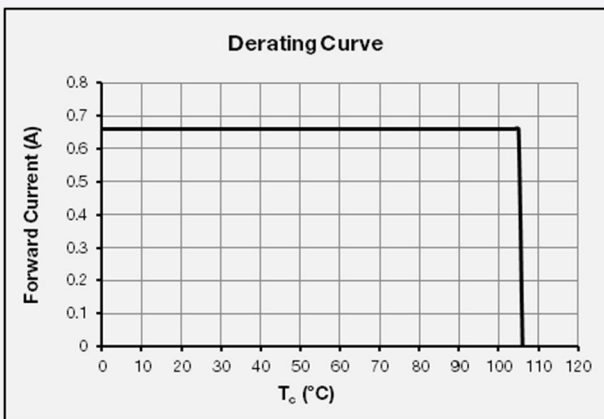

f) Beam Angle Characteristics ( $I_F = 360 \text{ mA}$ ,  $T_c = 25 \text{ }^\circ\text{C}$ )

80 CRI

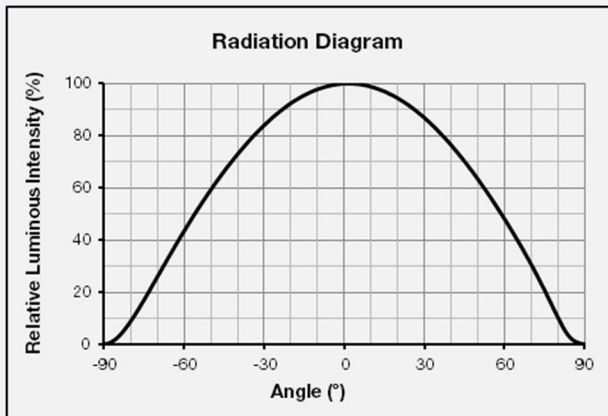

90 CRI

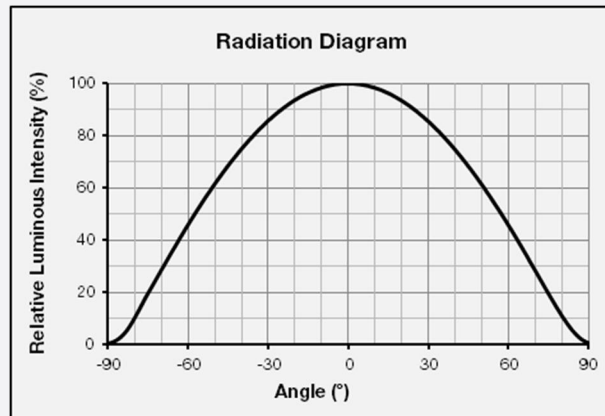

#### 4. Outline Drawing & Dimension

1. Unit: mm
2. Tolerance:  $\pm 0.15$  mm

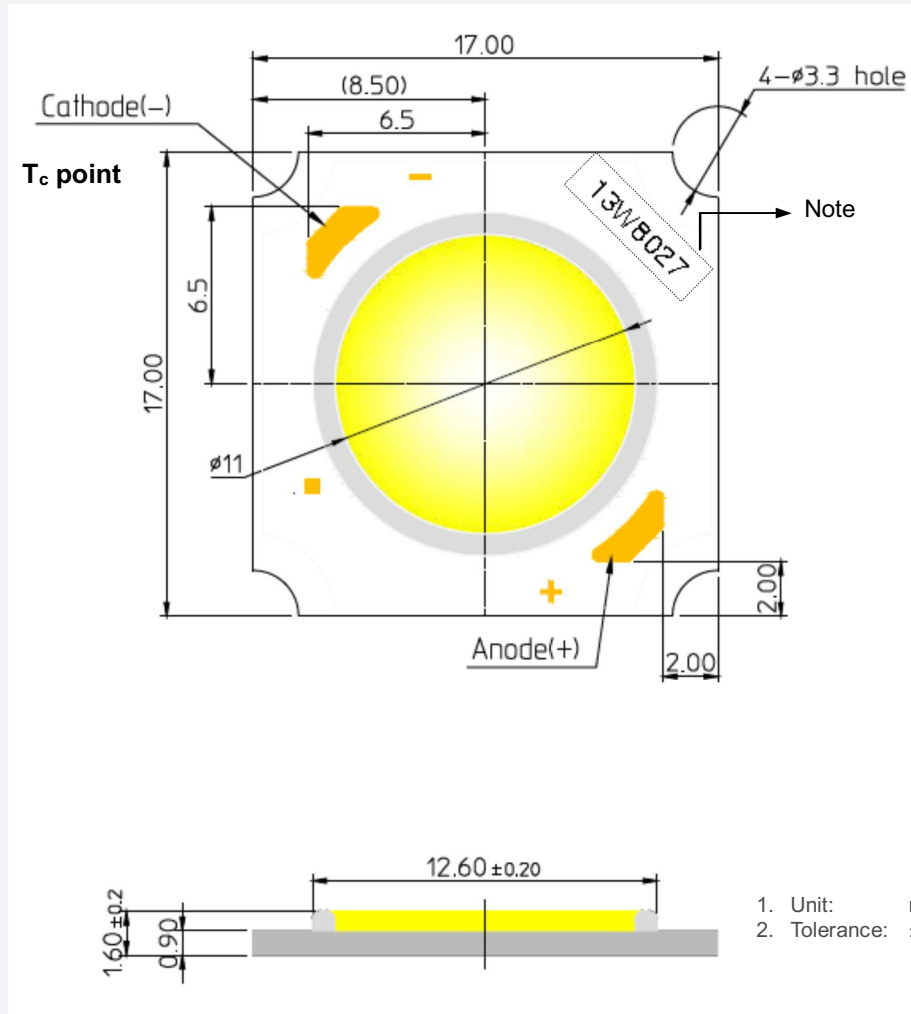

1. Unit: mm
2. Tolerance:  $\pm 0.2$  mm

Item	Dimension	Tolerance	Unit
Length	17.0	$\pm 0.15$	mm
Width	17.0	$\pm 0.15$	mm
Height	1.50	$\pm 0.20$	mm
Light Emitting Surface (LES) Diameter	11	$\pm 0.15$	mm

Note: Denoted product information above is only an example  
 ( 13W8027 : 13W, CRI80+, 2700K )

## 5. Reliability Test Items & Conditions

### a) Test Items

Test Item	Test Condition	Test Hour / Cycle
Room Temperature Life Test	25 °C, I <sub>F</sub> = max	1000 h
High Temperature Humidity Life Test	85 °C, 85 % RH, DC Derating, I <sub>F</sub> = max	1000 h
High Temperature Life Test	105 °C, DC Derating, I <sub>F</sub> = max	1000 h
Low Temperature Life Test	-40 °C, DC 660 mA	1000 h
High Temperature Storage	120 °C	1000 h
Low Temperature Storage	-40 °C	1000 h
Thermal Shock	-45 °C / 15 min ↔ 125 °C / 15 min temperature change in 5 min	200 cycles
Temperature Cycle On/Off Test	-40 °C / 85 °C each 20 min, 100 min transfer power on/off each 5 min, DC 360 mA	100 cycles
Temperature Humidity Storage Test	-10 °C ↔ 25 °C, 95 % RH ↔ 85 °C, 95 % RH (24 h / cycle)	100 cycles
ESD (HBM)	R <sub>1</sub> : 10 MΩ R <sub>2</sub> : 1.5 kΩ C: 100 pF V: ±2 kV	5 times
ESD (MM)	R <sub>1</sub> : 10 MΩ R <sub>2</sub> : 0 kΩ C: 200 pF V: ±0.5 kV	5 times
Vibration Test	20 ~ 80 Hz (displacement: 0.06 inch, max. 20 g) 80 ~ 2 kHz (max. 20 g) min. frequency ↔ max. frequency 4 min transfer	4 times
Mechanical Shock Test	1500 g, 0.5 ms each of the 6 surfaces (3 axis x 2 sides)	5 times
Salt Spray Test	35 °C, 5 % salt water 8 h spray, 16 h dwell	2 cycles

### b) Criteria for Judging the Damage

Item	Symbol	Test Condition (T <sub>c</sub> = 25 °C)	Limit	
			Min.	Max.
Forward Voltage	V <sub>F</sub>	I <sub>F</sub> = 360 mA	L.S.L. * 0.9	U.S.L. * 1.1
Luminous Flux	Φ <sub>v</sub>	I <sub>F</sub> = 360 mA	L.S.L. * 0.7	U.S.L. * 1.3

## 6. Label Structure

### a) Label Structure

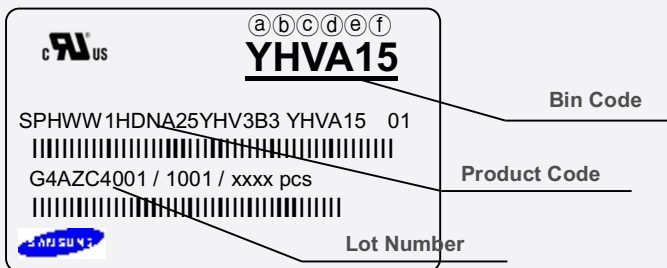

Note: Denoted bin code and product code above is only an example (see description on page 5)

Bin Code:

- ⒶⒷ: Forward Voltage bin (refer to page 11)
- ⒸⒹ: Chromaticity bin (refer to page 9-10)
- ⒺⒻ: Luminous Flux bin (refer to page 6)

### b) Lot Number

The lot number is composed of the following characters:

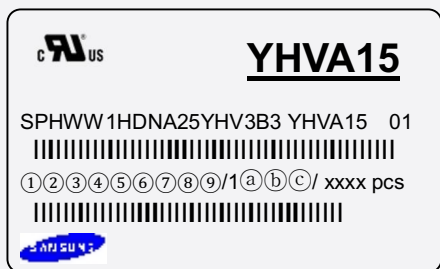

① ③④⑤⑥⑦⑧⑨ / 1ⒶⒷⒸ / xxxx pcs

- ① : Production site (S: Giheung, Korea, G: Tianjin, China)
- ② : 4 (LED)
- ③ : Product state (A: Normal, B: Bulk, C: First Production, R: Reproduction, S: Sample)
- ④ : Year (Z: 2015, A: 2016, B: 2017...)
- ⑤ : Month (1~9, A, B, C)
- ⑥⑦⑧⑨ : Day (1~9, A, B~V)
- ⒶⒷⒸ : Product serial number (001 ~ 999)

## 7. Packing Structure

Packing material	Max. quantity in pcs of COB	Dimension (mm)			Tolerance
		Length	Width	Height	
Tray	40	260	190	11.5	1.0
Anti-static Bag	200 (6 trays)	387	350	-	10.0
Box	1,400 (7 anti-static bag)	-	-	-	-

### a) Packing Structure

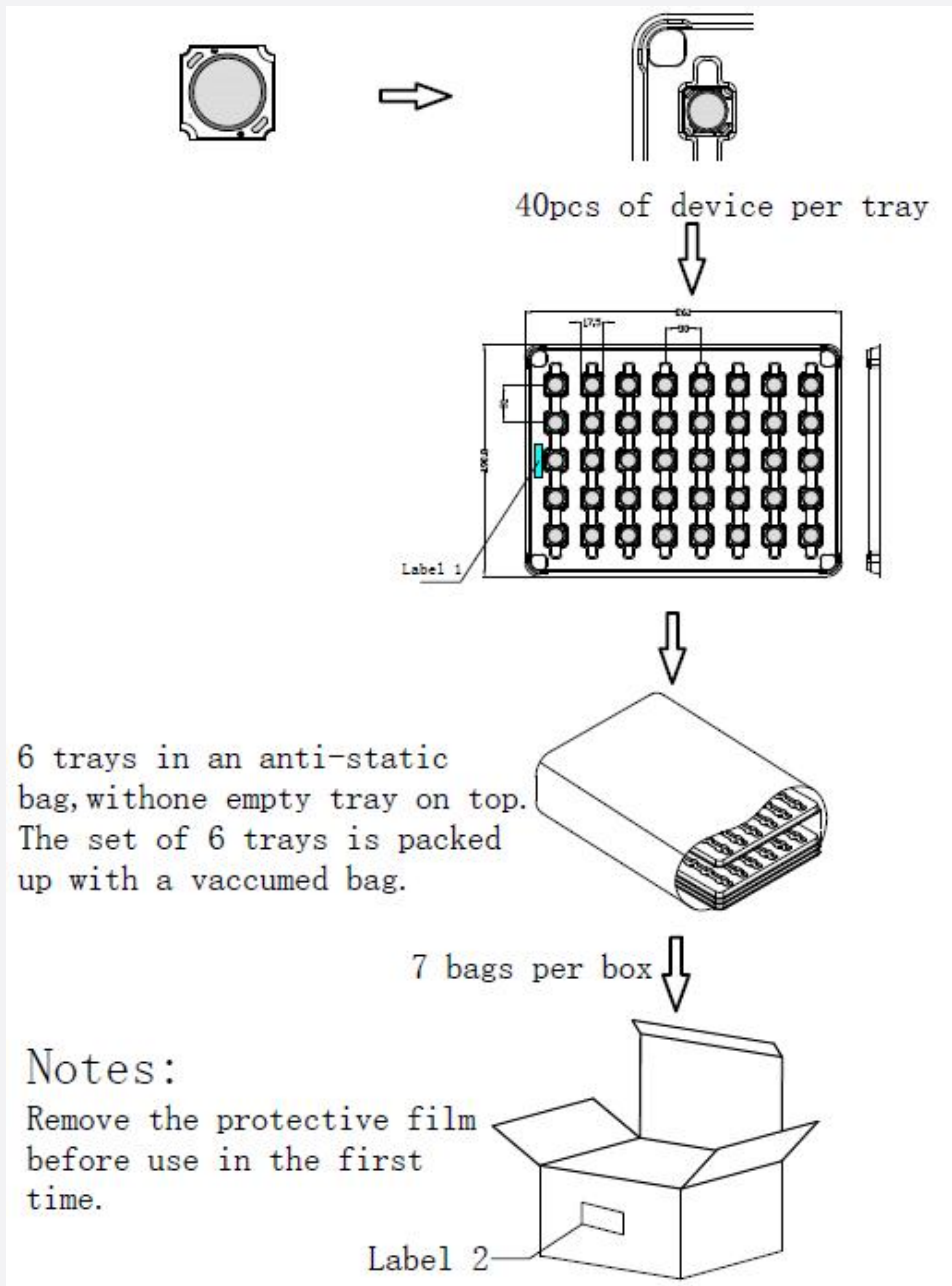

b) Tray

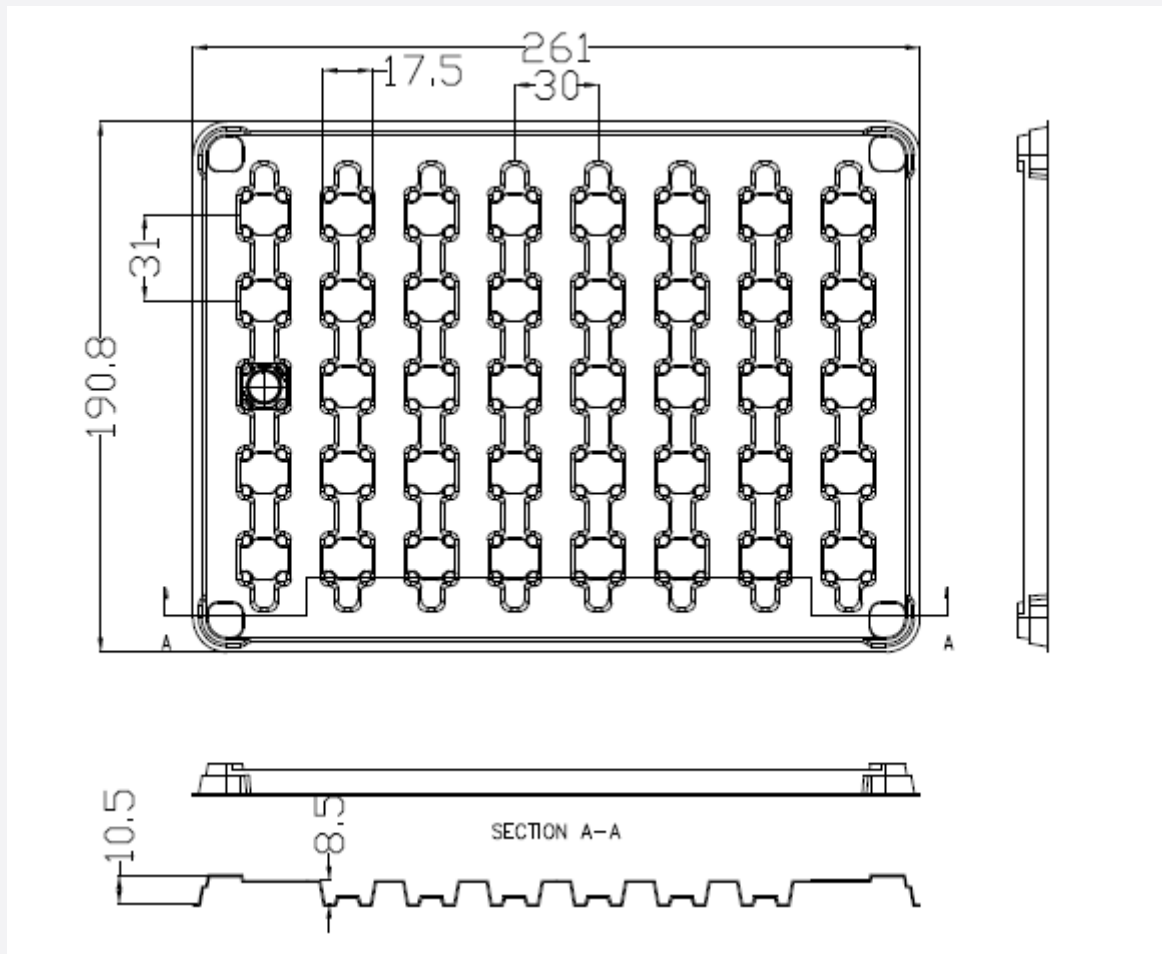

C) Anti-static Bag

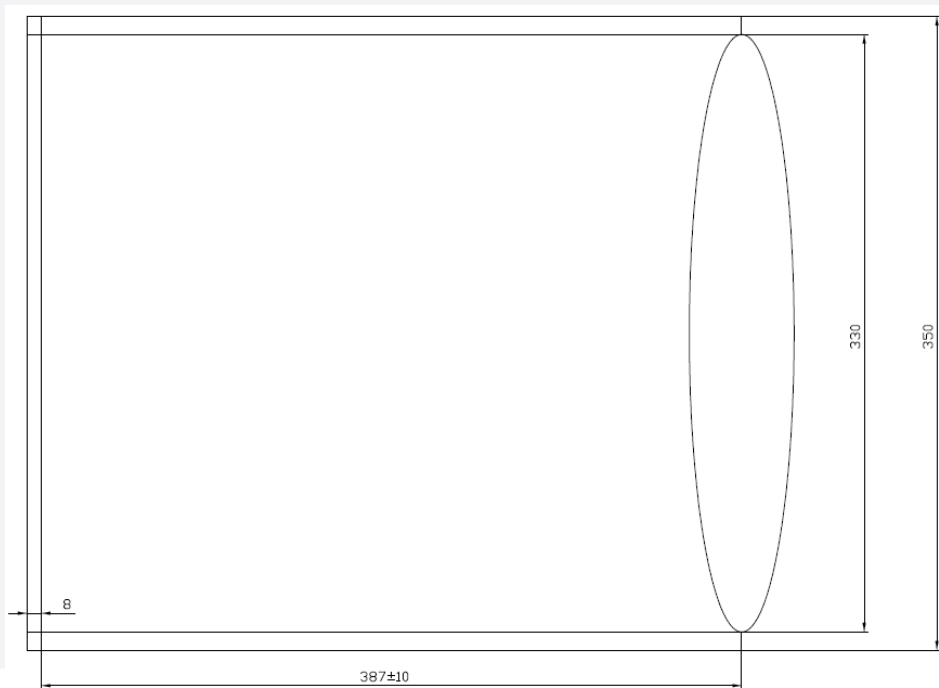

## 8. Precautions in Handling & Use

- 1) This device should not be used in any type of fluid such as water, oil, organic solvent, etc. When cleaning is required, IPA is recommended as the cleaning agent. Some solvent-based cleaning agent may damage the silicone resins used in the device.
- 2) LEDs must be stored in a clean environment. If the LEDs are to be stored for three months or more after being shipped from Samsung, they should be packed with a nitrogen-filled container (shelf life of sealed bags is 12 months at temperature 0~40 °C, 0~90 % RH).
- 3) After storage bag is opened, device subjected to soldering, solder reflow, or other high temperature processes must be:
  - a. Mounted within 672 hours (28 days) at an assembly line with a condition of no more than 30 °C / 60 % RH, or
  - b. Stored at <10 % RH
- 4) Repack unused products with anti-moisture packing, fold to close any opening and then store in a dry place.
- 5) Devices require baking before mounting, if humidity card reading is >60 % at 23 ± 5 °C.
- 6) Devices must be baked for 1 hour at 60 ± 5 °C, if baking is required.
- 7) The LEDs are sensitive to the static electricity and surge current. It is recommended to use a wrist band or anti-electrostatic glove when handling the LEDs. If voltage exceeding the absolute maximum rating is applied to LEDs, it may cause damage or even destruction to LED devices. Damaged LEDs may show some unusual characteristics such as increase in leakage current, lowered turn-on voltage, or abnormal lighting of LEDs at low current.
- 8) In case of driving the LC013B around the extremely low current level, chips might exhibit different brightness due to the variation in I-V characteristics of each one. This is normal and does not adversely affect the performance of product.
- 9) VOCs (Volatile Organic Compounds) can be generated from adhesives, flux, hardener or organic additives used in luminaires (fixtures). Transparent LED silicone encapsulant is permeable to those chemicals and they may lead to a discoloration of encapsulant when they exposed to heat or light. This phenomenon can cause a significant loss of light emitted (output) from the luminaires. In order to prevent these problems, we recommend users to know the physical properties of materials used in luminaires and they must be carefully selected.
- 10) The resin area is very sensitive, please do not handle, press, touch, rub, clean, or pick by with tweezers on it. Instead, please pick at the handling area as indicated below.

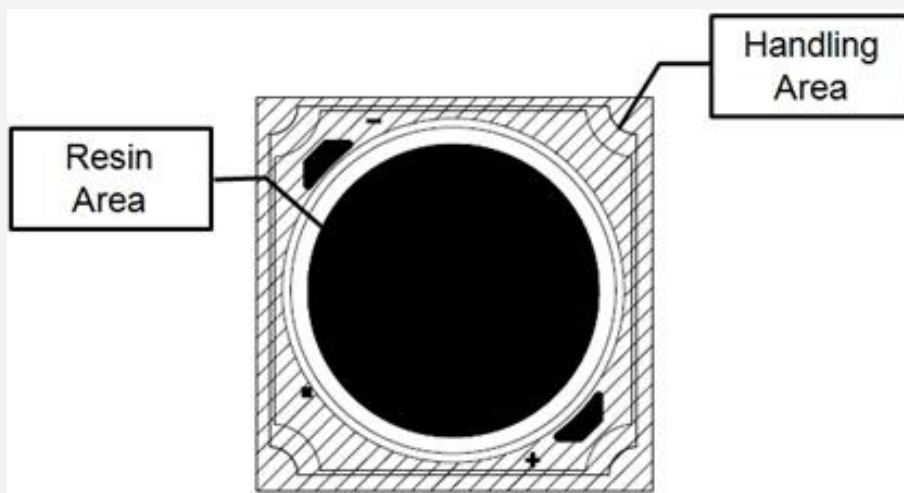

# Legal and additional information.

## [About Samsung Electronics Co., Ltd.](#)

Samsung Electronics Co., Ltd. inspires the world and shapes the future with transformative ideas and technologies, redefining the worlds of TVs, smartphones, wearable devices, tablets, cameras, digital appliances, printers, medical equipment, network systems and semiconductors.

We are also leading in the Internet of Things space through, among others, our Digital Health and Smart Home initiatives. We employ 307,000 people across 84 countries. To discover more, please visit our official website at [www.samsung.com](http://www.samsung.com) and our official blog at [global.samsungtomorrow.com](http://global.samsungtomorrow.com).

Copyright © 2015 Samsung Electronics Co., Ltd. All rights reserved.

Samsung is a registered trademark of Samsung Electronics Co., Ltd.

Specifications and designs are subject to change without notice. Non-metric weights and measurements are approximate. All data were deemed correct at time of creation. Samsung is not liable for errors or omissions. All brand, product, service names and logos are trademarks and/or registered trademarks of their respective owners and are hereby recognized and acknowledged.



Samsung Electronics Co., Ltd.  
95, Samsung 2-ro  
Giheung-gu  
Yongin-si, Gyeonggi-do, 446-711  
KOREA

[www.samsungled.com](http://www.samsungled.com)









## Looking for pricing, stock, or lifecycle information?

Click below to explore more details on WIN SOURCE:

-  [View SPHCW1HDNA25YHRTB3 on WIN SOURCE](#)
-  [Samsung Information](#)

## Optimize Your Supply Chain with WIN SOURCE Solutions

-  Global Sourcing Solution
-  Obsolete Management
-  Cost Control Management
-  Shortage Management
-  Alternative Solution
-  Excess Inventory Management