



**THE DATASHEET OF
SPHWAHDND27YZU3D1**



[About Samsung Electronics Co., Ltd.](#)

Samsung Electronics Co. Ltd inspires the world and shapes the future with transformative ideas and technologies. The company is redefining the worlds of TVs, smartphones, wearable devices, tablets, digital appliances, network systems, and semiconductor and LED solutions. For the latest news, please visit the Samsung Newsroom at <http://news.samsung.com>.

Copyright 2019 Samsung Electronics Co., Ltd. All rights reserved.
Samsung Electronics reserves the right to modify, at its sole discretion, the design, packaging, specifications, and features shown herein without notice at any time.

Samsung Electronics Co., Ltd.
Samsung-ro 1, Giheung-gu, Yongin-si,
Gyeonggi-do, 17113 Korea

www.samsungled.com



Samsung LED
Retail
Lighting Solutions

Increasing Demand for High Color Quality



Perfect Atmosphere Created by Light

Carefully tuned light intensity and color can influence customers' behavior. It can lead customers to stay longer in the store and eventually result in sales increase



Adam de Guerra_Design Director, Glowing Structure (Light. Space. Design Summit, March 2019 Australia)

Lightings Go Natural

Market demands for more accurate rendering of natural color increased significantly from 4% to 49%



Energy Efficient Light Source

Industry-leading Efficacy

Superior performance based on advanced LED technologies, Samsung COB series provide the industry-leading light efficacy



High Reliability

Metal substrate and small chip structure enable low thermal resistance and high reliability



High Color Quality

High Color Consistency

All COB LEDs are available in 2-step MacAdam ellipse and also 1-step



Superior Color Rendering

Ultra High CRI (Ra 95+): Typ. R9 ≈ 90



Advanced Spectrum Engineering

Samsung spectrum engineering creates the special color for retail lighting



One Stop Solution

A wide range of wattage and CRI options

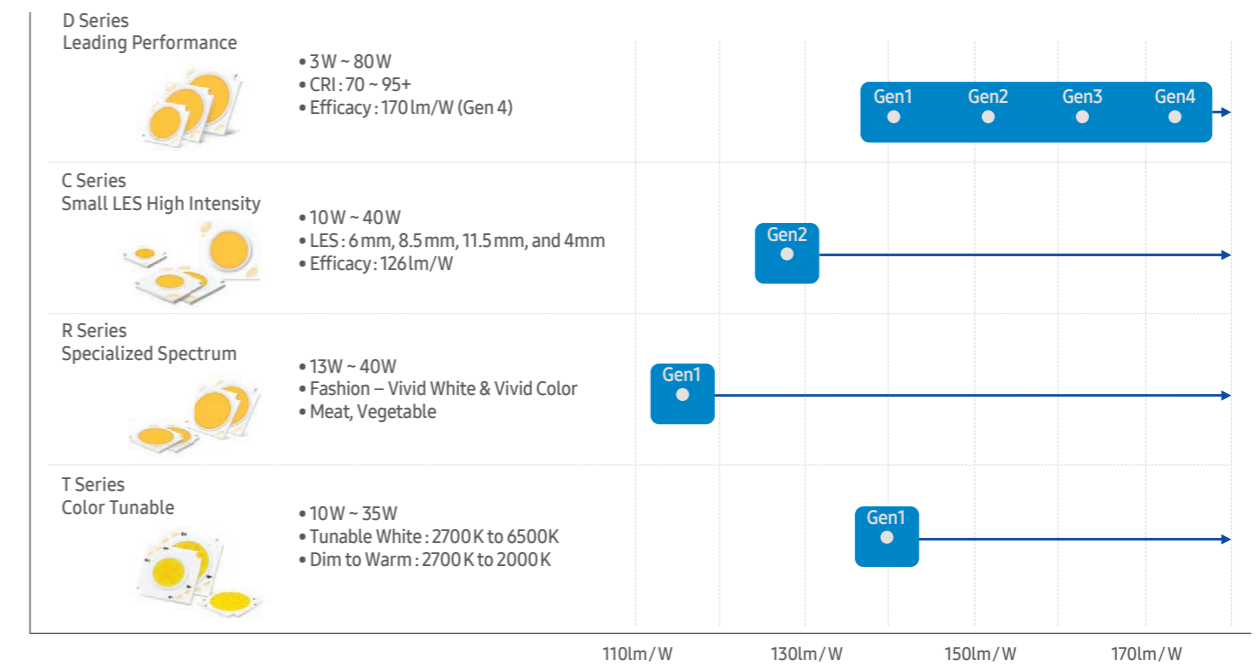

D-Series

Flawless Lighting, Anywhere

Selective quality standards certify superior lights for all applications

D-series with Leading Performance

Industry-leading performance in a wide range of wattage and CRI options

The industry-leading performance

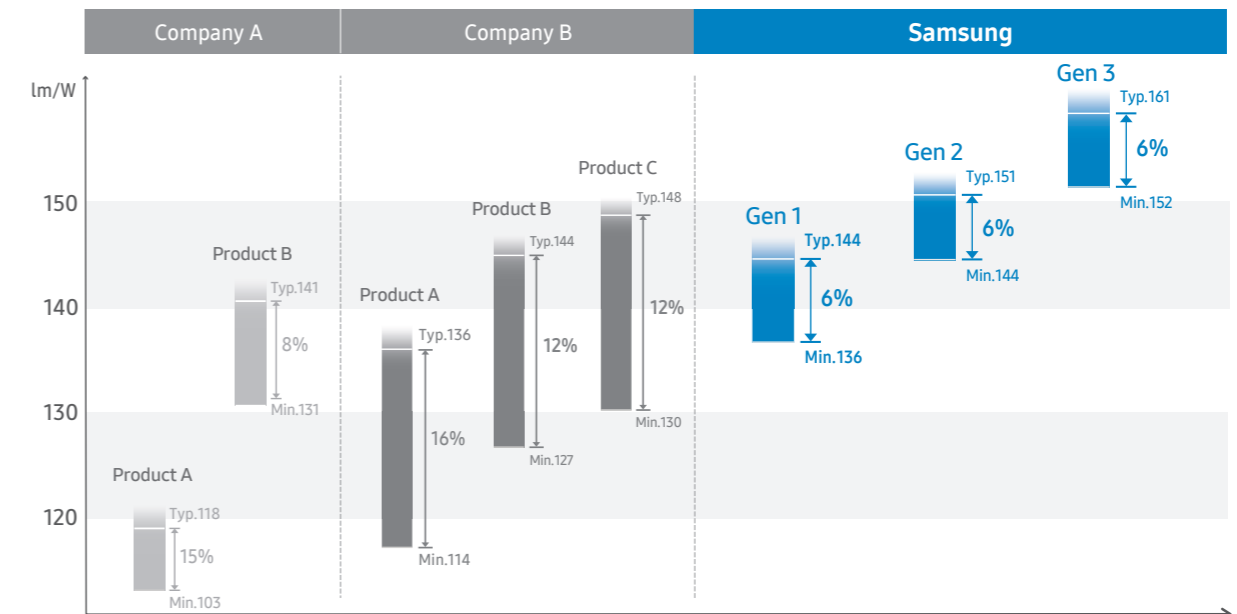

A wide range of wattage and CRI options

D-series	Model LES	Wattage										
		3W	6W	9W	13W	16W	19W	26W	33W	40W	60W	80W
Gen 1 D1 rank: 143lm/W D0 rank: 136lm/W	CRI 70+										●	●
	CRI 80+	●	●	●	●	●	●	●		●	●	●
	CRI 90+	●	●	●	●	●	●	●		●		
Gen 2 D2 rank: 151lm/W	CRI 70+			●	●	●	●	●	●	●	●	●
	CRI 80+	●	●	●	●	●	●	●	●	●	●	●
	CRI 90+	●	●	●	●	●	●	●	●	●	●	●
Gen 3 D3 rank: 161lm/W	CRI 70+			●	●	●	●	●	●	●	●	●
	CRI 80+	●	●	●	●	●	●	●	●	●	●	●
	CRI 90+	●	●	●	●	●	●	●	●	●	●	●



D-series Gen 3

T _j =85°C	LC003D Gen 3	LC006D Gen 3	LC009D Gen 3	LC013D Gen 3	LC016D Gen 3	LC019D Gen 3	LC026D Gen 3	LC033D Gen 3	LC040D Gen 3	LC060D Gen 3	LC080D Gen 3	
LES	9.8mm			14.5mm				22mm				
Typical	33.8V											50.7V
	3.0W (90mA)	6.1W (180mA)	9.1W (270mA)	12.2W (360mA)	15.2W (450mA)	18.3W (540mA)	24.3W (720mA)	30.4W (900mA)	36.5W (1080mA)	54.8W (1080mA)	82.1W (1620mA)	
Max.	8.7W (230mA)	17.4W (460mA)	26.1W (690mA)	34.8W (920mA)	43.5W (1150mA)	52.2W (1380mA)	69.6W (1840mA)	86.9W (2300mA)	104.3W (2760mA)	152.9W (2760mA)	229.3W (4140mA)	
Size	13.5mm x 13.5mm			19mm x 19mm				28mm x 28mm				

Color Variation

* CRI: Minimum

Product	CRI90+					CRI80+							CRI70+		
	2700K	3000K	3500K	4000K	5000K	2700K	3000K	3500K	4000K	5000K	5700K	6500K	3000K	4000K	5000K
LC003D Gen3	0	0	0	0	0	0	0	0	0	0	0	0			
LC006D Gen3	0	0	0	0	0	0	0	0	0	0	0	0			
LC009D Gen3	0	0	0	0	0	0	0	0	0	0	0	0	0	0	0
LC013D Gen3	0	0	0	0	0	0	0	0	0	0	0	0	0	0	0
LC016D Gen3	0	0	0	0	0	0	0	0	0	0	0	0	0	0	0
LC019D Gen3	0	0	0	0	0	0	0	0	0	0	0	0	0	0	0
LC026D Gen3	0	0	0	0	0	0	0	0	0	0	0	0	0	0	0
LC033D Gen3	0	0	0	0	0	0	0	0	0	0	0	0	0	0	0
LC040D Gen3	0	0	0	0	0	0	0	0	0	0	0	0	0	0	0
LC060D Gen3	0	0	0	0	0	0	0	0	0	0	0	0	0	0	0
LC080D Gen3	0	0	0	0	0	0	0	0	0	0	0	0	0	0	0
MacAdam 2-Step	0	0	0	0		0	0	0	0						
MacAdam 3-Step	0	0	0	0	0	0	0	0	0	0	0	0	0	0	0

Specifications

Product	CRI	CCT (K)	Color Rank	Part Number	T _j = 85°C		I _F (mA) V _F (V)		
					Luminous Flux Typ. (lm)	Luminous Efficacy Typ. (lm/W)			
 LC003D Gen 3	80+	2700	MacAdam 2step	SPHWAHDNA25YZW2D3	475	156	90mA 33.8V		
			MacAdam 3step	SPHWAHDNA25YZW3D3					
		3000	MacAdam 2step	SPHWAHDNA25YZV2D3	499	164			
			MacAdam 3step	SPHWAHDNA25YZV3D3					
		3500	MacAdam 2step	SPHWAHDNA25YZU2D3	514	169			
			MacAdam 3step	SPHWAHDNA25YZU3D3					
		4000	MacAdam 2step	SPHWAHDNA25YZT2D3	524	172			
			MacAdam 3step	SPHWAHDNA25YZT3D3					
		5000	MacAdam 3step	SPHWAHDNA25YZR3D3	529	174			
		5700	MacAdam 3step	SPHWAHDNA25YZQ3D3	529	174			
		6500	MacAdam 3step	SPHWAHDNA25YZP3D3	524	172			
		 LC006D Gen 3	90+	2700	MacAdam 2step	SPHWAHDNA27YZW2D3		407	134
					MacAdam 3step	SPHWAHDNA27YZW3D3			
				3000	MacAdam 2step	SPHWAHDNA27YZV2D3		428	141
MacAdam 3step	SPHWAHDNA27YZV3D3								
3500	MacAdam 2step			SPHWAHDNA27YZU2D3	441	145			
	MacAdam 3step			SPHWAHDNA27YZU3D3					
4000	MacAdam 2step			SPHWAHDNA27YZT2D3	450	148			
	MacAdam 3step			SPHWAHDNA27YZT3D3					
5000	MacAdam 3step			SPHWAHDNA27YZR3D3	453	149			
 LC006D Gen 3	80+			2700	MacAdam 2step	SPHWAHDNB25YZW2D3	946	155	180mA 33.8V
		MacAdam 3step	SPHWAHDNB25YZW3D3						
		3000	MacAdam 2step	SPHWAHDNB25YZV2D3	994	163			
			MacAdam 3step	SPHWAHDNB25YZV3D3					
		3500	MacAdam 2step	SPHWAHDNB25YZU2D3	1023	168			
			MacAdam 3step	SPHWAHDNB25YZU3D3					
		4000	MacAdam 2step	SPHWAHDNB25YZT2D3	1043	171			
			MacAdam 3step	SPHWAHDNB25YZT3D3					
		5000	MacAdam 3step	SPHWAHDNB25YZR3D3	1052	173			
		5700	MacAdam 3step	SPHWAHDNB25YZQ3D3	1052	173			
		6500	MacAdam 3step	SPHWAHDNB25YZP3D3	1043	171			
		 LC006D Gen 3	90+	2700	MacAdam 2step	SPHWAHDNB27YZW2D3	809	133	
					MacAdam 3step	SPHWAHDNB27YZW3D3			
				3000	MacAdam 2step	SPHWAHDNB27YZV2D3	851	140	
MacAdam 3step	SPHWAHDNB27YZV3D3								
3500	MacAdam 2step			SPHWAHDNB27YZU2D3	877	144			
	MacAdam 3step			SPHWAHDNB27YZU3D3					
4000	MacAdam 2step			SPHWAHDNB27YZT2D3	895	147			
	MacAdam 3step			SPHWAHDNB27YZT3D3					
5000	MacAdam 3step	SPHWAHDNB27YZR3D3	902	148					

Specifications

D-series

Product	CRI	CCT (K)	Color Rank	Part Number	T _j = 85°C		I _F (mA) V _F (V)
					Luminous Flux Typ. (lm)	Luminous Efficacy Typ. (lm/W)	
 LC009D Gen 3	70+	3000	MacAdam 3step	SPHWAHDNC23YZV3D3	1594	174	270mA 33.8V
		4000	MacAdam 3step	SPHWAHDNC23YT3D3	1624	177	
		5000	MacAdam 3step	SPHWAHDNC23YZR3D3	1653	180	
	80+	2700	MacAdam 2step	SPHWAHDNC25YZW2D3	1405	154	
			MacAdam 3step	SPHWAHDNC25YZW3D3			
		3000	MacAdam 2step	SPHWAHDNC25YZV2D3	1476	162	
			MacAdam 3step	SPHWAHDNC25YZV3D3			
		3500	MacAdam 2step	SPHWAHDNC25YZU2D3	1519	166	
			MacAdam 3step	SPHWAHDNC25YZU3D3			
		4000	MacAdam 2step	SPHWAHDNC25YT2D3	1550	170	
			MacAdam 3step	SPHWAHDNC25YT3D3			
		5000	MacAdam 3step	SPHWAHDNC25YZR3D3	1563	171	
			5700	MacAdam 3step	SPHWAHDNC25YZQ3D3	1563	
		6500	MacAdam 3step	SPHWAHDNC25YZP3D3	1550	170	
		90+	2700	MacAdam 2step	SPHWAHDNC27YZW2D3	1202	
	MacAdam 3step			SPHWAHDNC27YZW3D3			
	3000		MacAdam 2step	SPHWAHDNC27YZV2D3	1264	139	
			MacAdam 3step	SPHWAHDNC27YZV3D3			
	3500		MacAdam 2step	SPHWAHDNC27YZU2D3	1302	143	
			MacAdam 3step	SPHWAHDNC27YZU3D3			
	4000		MacAdam 2step	SPHWAHDNC27YT2D3	1329	146	
			MacAdam 3step	SPHWAHDNC27YT3D3			
	5000		MacAdam 3step	SPHWAHDNC27YZR3D3	1340	147	
	70+		3000	MacAdam 3step	SPHWAHDND23YZV3D3	2094	
4000				MacAdam 3step	SPHWAHDND23YT3D3	2133	174
5000				MacAdam 3step	SPHWAHDND23YZR3D3	2171	177
80+		2700	MacAdam 2step	SPHWAHDND25YZW2D3	1845	152	
			MacAdam 3step	SPHWAHDND25YZW3D3			
		3000	MacAdam 2step	SPHWAHDND25YZV2D3	1939	159	
			MacAdam 3step	SPHWAHDND25YZV3D3			
		3500	MacAdam 2step	SPHWAHDND25YZU2D3	1996	164	
			MacAdam 3step	SPHWAHDND25YZU3D3			
4000		MacAdam 2step	SPHWAHDND25YT2D3	2036	167		
		MacAdam 3step	SPHWAHDND25YT3D3				
5000		MacAdam 3step	SPHWAHDND25YZR3D3	2053	169		
5700	MacAdam 3step	SPHWAHDND25YZQ3D3	2053	169			
6500	MacAdam 3step	SPHWAHDND25YZP3D3	2036	167			
90+	2700	MacAdam 2step	SPHWAHDND27YZW2D3	1579	130		
		MacAdam 3step	SPHWAHDND27YZW3D3				
	3000	MacAdam 2step	SPHWAHDND27YZV2D3	1661	137		
		MacAdam 3step	SPHWAHDND27YZV3D3				
	3500	MacAdam 2step	SPHWAHDND27YZU2D3	1710	141		
		MacAdam 3step	SPHWAHDND27YZU3D3				
	4000	MacAdam 2step	SPHWAHDND27YT2D3	1745	143		
		MacAdam 3step	SPHWAHDND27YT3D3				
	5000	MacAdam 3step	SPHWAHDND27YZR3D3	1760	145		



LC013D Gen 3

Product	CRI	CCT (K)	Color Rank	Part Number	T _j = 85°C		I _F (mA) V _F (V)
					Luminous Flux Typ. (lm)	Luminous Efficacy Typ. (lm/W)	
 LC016D Gen 3	70+	3000	MacAdam 3step	SPHWAHDNE23YZV3D3	2697	176	450mA 33.8V
		4000	MacAdam 3step	SPHWAHDNE23YT3D3	2747	180	
		5000	MacAdam 3step	SPHWAHDNE23YZR3D3	2797	183	
	80+	2700	MacAdam 2step	SPHWAHDNE25YZW2D3	2376	156	
			MacAdam 3step	SPHWAHDNE25YZW3D3			
		3000	MacAdam 2step	SPHWAHDNE25YZV2D3	2497	164	
			MacAdam 3step	SPHWAHDNE25YZV3D3			
		3500	MacAdam 2step	SPHWAHDNE25YZU2D3	2570	169	
			MacAdam 3step	SPHWAHDNE25YZU3D3			
		4000	MacAdam 2step	SPHWAHDNE25YT2D3	2622	172	
			MacAdam 3step	SPHWAHDNE25YT3D3			
		5000	MacAdam 3step	SPHWAHDNE25YZR3D3	2644	174	
		5700	MacAdam 3step	SPHWAHDNE25YZQ3D3	2644	174	
		6500	MacAdam 3step	SPHWAHDNE25YZP3D3	2622	172	
		90+	2700	MacAdam 2step	SPHWAHDNE27YZW2D3	2033	
	MacAdam 3step			SPHWAHDNE27YZW3D3			
	3000		MacAdam 2step	SPHWAHDNE27YZV2D3	2139	141	
			MacAdam 3step	SPHWAHDNE27YZV3D3			
	3500		MacAdam 2step	SPHWAHDNE27YZU2D3	2203	145	
			MacAdam 3step	SPHWAHDNE27YZU3D3			
	4000		MacAdam 2step	SPHWAHDNE27YT2D3	2248	148	
			MacAdam 3step	SPHWAHDNE27YT3D3			
	5000		MacAdam 3step	SPHWAHDNE27YZR3D3	2267	149	
	70+		3000	MacAdam 3step	SPHWAHDNF23YZV3D3	3220	
4000				MacAdam 3step	SPHWAHDNF23YT3D3	3280	179
5000				MacAdam 3step	SPHWAHDNF23YZR3D3	3339	182
80+		2700	MacAdam 2step	SPHWAHDNF25YZW2D3	2837	155	
			MacAdam 3step	SPHWAHDNF25YZW3D3			
		3000	MacAdam 2step	SPHWAHDNF25YZV2D3	2982	163	
			MacAdam 3step	SPHWAHDNF25YZV3D3			
		3500	MacAdam 2step	SPHWAHDNF25YZU2D3	3069	168	
			MacAdam 3step	SPHWAHDNF25YZU3D3			
4000		MacAdam 2step	SPHWAHDNF25YT2D3	3130	171		
		MacAdam 3step	SPHWAHDNF25YT3D3				
5000		MacAdam 3step	SPHWAHDNF25YZR3D3	3157	173		
5700	MacAdam 3step	SPHWAHDNF25YZQ3D3	3157	173			
6500	MacAdam 3step	SPHWAHDNF25YZP3D3	3130	171			
90+	2700	MacAdam 2step	SPHWAHDNF27YZW2D3	2428	133		
		MacAdam 3step	SPHWAHDNF27YZW3D3				
	3000	MacAdam 2step	SPHWAHDNF27YZV2D3	2554	140		
		MacAdam 3step	SPHWAHDNF27YZV3D3				
	3500	MacAdam 2step	SPHWAHDNF27YZU2D3	2630	144		
		MacAdam 3step	SPHWAHDNF27YZU3D3				
	4000	MacAdam 2step	SPHWAHDNF27YT2D3	2684	147		
		MacAdam 3step	SPHWAHDNF27YT3D3				
	5000	MacAdam 3step	SPHWAHDNF27YZR3D3	2707	148		







LC019D Gen 3

D-series

Specifications

D-series

Product	CRI	CCT (K)	Color Rank	Part Number	T _j = 85°C		I _F (mA) V _F (V)
					Luminous Flux Typ. (lm)	Luminous Efficacy Typ. (lm/W)	
 LC026D Gen 3	70+	3000	MacAdam 3step	SPHWAHDNG23YZV3D3	4230	174	720mA 33.8V
		4000	MacAdam 3step	SPHWAHDNG23YZT3D3	4308	177	
		5000	MacAdam 3step	SPHWAHDNG23YZR3D3	4387	180	
	80+	2700	MacAdam 2step	SPHWAHDNG25YZW2D3	3727	153	
			MacAdam 3step	SPHWAHDNG25YZW3D3			
		3000	MacAdam 2step	SPHWAHDNG25YZV2D3	3917	161	
			MacAdam 3step	SPHWAHDNG25YZV3D3			
		3500	MacAdam 2step	SPHWAHDNG25YZU2D3	4032	166	
			MacAdam 3step	SPHWAHDNG25YZU3D3			
	4000	MacAdam 2step	SPHWAHDNG25YZT2D3	4112	169		
		MacAdam 3step	SPHWAHDNG25YZT3D3				
	90+	5000	MacAdam 3step	SPHWAHDNG25YZR3D3	4147	170	
			MacAdam 3step	SPHWAHDNG25YZQ3D3			
			MacAdam 3step	SPHWAHDNG25YZP3D3			
		2700	MacAdam 2step	SPHWAHDNG27YZW2D3	3190	131	
			MacAdam 3step	SPHWAHDNG27YZW3D3			
		3000	MacAdam 2step	SPHWAHDNG27YZV2D3	3355	138	
	MacAdam 3step		SPHWAHDNG27YZV3D3				
	3500	MacAdam 2step	SPHWAHDNG27YZU2D3	3455	142		
		MacAdam 3step	SPHWAHDNG27YZU3D3				
4000	MacAdam 2step	SPHWAHDNG27YZT2D3	3526	145			
	MacAdam 3step	SPHWAHDNG27YZT3D3					
5000	MacAdam 3step	SPHWAHDNG27YZR3D3	3556	146			
	MacAdam 3step	SPHWAHDNG27YZQ3D3					
 LC033D Gen 3	70+	3000	MacAdam 3step	SPHWAHDNH23YZV3D3	5235	172	900mA 33.8V
		4000	MacAdam 3step	SPHWAHDNH23YZT3D3	5332	175	
		5000	MacAdam 3step	SPHWAHDNH23YZR3D3	5429	178	
	80+	2700	MacAdam 2step	SPHWAHDNH25YZW2D3	4612	152	
			MacAdam 3step	SPHWAHDNH25YZW3D3			
		3000	MacAdam 2step	SPHWAHDNH25YZV2D3	4847	159	
			MacAdam 3step	SPHWAHDNH25YZV3D3			
		3500	MacAdam 2step	SPHWAHDNH25YZU2D3	4989	164	
			MacAdam 3step	SPHWAHDNH25YZU3D3			
	4000	MacAdam 2step	SPHWAHDNH25YZT2D3	5089	167		
		MacAdam 3step	SPHWAHDNH25YZT3D3				
	5000	MacAdam 3step	SPHWAHDNH25YZR3D3	5132	169		
		MacAdam 3step	SPHWAHDNH25YZQ3D3				
		MacAdam 3step	SPHWAHDNH25YZP3D3				

Product	CRI	CCT (K)	Color Rank	Part Number	T _j = 85°C		I _F (mA) V _F (V)
					Luminous Flux Typ. (lm)	Luminous Efficacy Typ. (lm/W)	
 LC033D Gen 3	90+	2700	MacAdam 2step	SPHWAHDNH27YZW2D3	3947	130	900mA 33.8V
			MacAdam 3step	SPHWAHDNH27YZW3D3			
		3000	MacAdam 2step	SPHWAHDNH27YZV2D3	4152	136	
			MacAdam 3step	SPHWAHDNH27YZV3D3			
		3500	MacAdam 2step	SPHWAHDNH27YZU2D3	4276	141	
			MacAdam 3step	SPHWAHDNH27YZU3D3			
	4000	MacAdam 2step	SPHWAHDNH27YZT2D3	4364	143		
		MacAdam 3step	SPHWAHDNH27YZT3D3				
	70+	3000	MacAdam 3step	SPHWAHDNK23YZV3D3	6440	176	
			MacAdam 3step	SPHWAHDNK23YZT3D3			
			MacAdam 3step	SPHWAHDNK23YZR3D3			
		2700	MacAdam 2step	SPHWAHDNK25YZW2D3	5675	155	
MacAdam 3step			SPHWAHDNK25YZW3D3				
MacAdam 3step			SPHWAHDNK25YZQ3D3				
80+	3000	MacAdam 2step	SPHWAHDNK25YZV2D3	5963	163		
		MacAdam 3step	SPHWAHDNK25YZV3D3				
	3500	MacAdam 2step	SPHWAHDNK25YZU2D3	6138	168		
		MacAdam 3step	SPHWAHDNK25YZU3D3				
	4000	MacAdam 2step	SPHWAHDNK25YZT2D3	6261	172		
		MacAdam 3step	SPHWAHDNK25YZT3D3				
5000	MacAdam 3step	SPHWAHDNK25YZR3D3	6313	173			
 LC040D Gen 3	90+	2700	MacAdam 2step	SPHWAHDNK27YZW2D3	4856	133	1080mA 33.8V
			MacAdam 3step	SPHWAHDNK27YZW3D3			
		3000	MacAdam 2step	SPHWAHDNK27YZV2D3	5108	140	
			MacAdam 3step	SPHWAHDNK27YZV3D3			
		3500	MacAdam 2step	SPHWAHDNK27YZU2D3	5260	144	
			MacAdam 3step	SPHWAHDNK27YZU3D3			
	4000	MacAdam 2step	SPHWAHDNK27YZT2D3	5369	147		
		MacAdam 3step	SPHWAHDNK27YZT3D3				
	5000	MacAdam 3step	SPHWAHDNK27YZR3D3	5415	148		
		MacAdam 3step	SPHWAHDNK27YZQ3D3				

D-series

Specifications

D-series

Product	CRI	CCT (K)	Color Rank	Part Number	T _j = 85°C		I _f (mA) V _F (V)
					Luminous Flux Typ. (lm)	Luminous Efficacy Typ. (lm/W)	
 LC060D Gen 3	70+	3000	MacAdam 3step	SPHWAHDNL231ZV3D3	9518	174	1080mA 50.7V
		4000	MacAdam 3step	SPHWAHDNL231ZT3D3	9694	177	
		5000	MacAdam 3step	SPHWAHDNL231ZR3D3	9870	180	
	80+	2700	MacAdam 2step	SPHWAHDNL251ZW2D3	8386	153	
			MacAdam 3step	SPHWAHDNL251ZW3D3			
		3000	MacAdam 2step	SPHWAHDNL251ZV2D3	8813	161	
			MacAdam 3step	SPHWAHDNL251ZV3D3			
		3500	MacAdam 2step	SPHWAHDNL251ZU2D3	9071	166	
			MacAdam 3step	SPHWAHDNL251ZU3D3			
		4000	MacAdam 2step	SPHWAHDNL251ZT2D3	9253	169	
			MacAdam 3step	SPHWAHDNL251ZT3D3			
		5000	MacAdam 3step	SPHWAHDNL251ZR3D3	9330	170	
		5700	MacAdam 3step	SPHWAHDNL251ZQ3D3	9330	170	
		6500	MacAdam 3step	SPHWAHDNL251ZP3D3	9253	169	
		90+	2700	MacAdam 2step	SPHWAHDNL271ZW2D3	7177	
	MacAdam 3step			SPHWAHDNL271ZW3D3			
	3000		MacAdam 2step	SPHWAHDNL271ZV2D3	7549	138	
			MacAdam 3step	SPHWAHDNL271ZV3D3			
	3500		MacAdam 2step	SPHWAHDNL271ZU2D3	7774	142	
			MacAdam 3step	SPHWAHDNL271ZU3D3			
	4000		MacAdam 2step	SPHWAHDNL271ZT2D3	7934	145	
			MacAdam 3step	SPHWAHDNL271ZT3D3			
	5000		MacAdam 3step	SPHWAHDNL271ZR3D3	8002	146	

Product	CRI	CCT (K)	Color Rank	Part Number	T _j = 85°C		I _f (mA) V _F (V)
					Luminous Flux Typ. (lm)	Luminous Efficacy Typ. (lm/W)	
 LC080D Gen 3	70+	3000	MacAdam 3step	SPHWAHDNM231ZV3D3	14115	172	1620mA 50.7V
		4000	MacAdam 3step	SPHWAHDNM231ZT3D3	14376	175	
		5000	MacAdam 3step	SPHWAHDNM231ZR3D3	14637	178	
	80+	2700	MacAdam 2step	SPHWAHDNM251ZW2D3	12437	151	
			MacAdam 3step	SPHWAHDNM251ZW3D3			
		3000	MacAdam 2step	SPHWAHDNM251ZV2D3	13069	159	
			MacAdam 3step	SPHWAHDNM251ZV3D3			
		3500	MacAdam 2step	SPHWAHDNM251ZU2D3	13452	164	
			MacAdam 3step	SPHWAHDNM251ZU3D3			
		4000	MacAdam 2step	SPHWAHDNM251ZT2D3	13721	167	
			MacAdam 3step	SPHWAHDNM251ZT3D3			
		5000	MacAdam 3step	SPHWAHDNM251ZR3D3	13836	168	
		5700	MacAdam 3step	SPHWAHDNM251ZQ3D3	13836	168	
		6500	MacAdam 3step	SPHWAHDNM251ZP3D3	13721	167	
		90+	2700	MacAdam 2step	SPHWAHDNM271ZW2D3	10643	
	MacAdam 3step			SPHWAHDNM271ZW3D3			
	3000		MacAdam 2step	SPHWAHDNM271ZV2D3	11195	136	
			MacAdam 3step	SPHWAHDNM271ZV3D3			
	3500		MacAdam 2step	SPHWAHDNM271ZU2D3	11529	140	
			MacAdam 3step	SPHWAHDNM271ZU3D3			
	4000		MacAdam 2step	SPHWAHDNM271ZT2D3	11766	143	
			MacAdam 3step	SPHWAHDNM271ZT3D3			
	5000		MacAdam 3step	SPHWAHDNM271ZR3D3	11867	144	

D-series

D-series Gen 2



T _j =85°C	LC003D Gen 2	LC006D Gen 2	LC009D Gen 2	LC013D Gen 2	LC016D Gen 2	LC019D Gen 2	LC026D Gen 2	LC033D Gen 2	LC040D Gen 2	LC060D Gen 2	LC080D Gen 2	
LES	9.8mm			14.5mm				22 mm				
Typical	34.6 V										52 V	
	3.1 W (90 mA)	6.2 W (180 mA)	9.4 W (270 mA)	12.5 W (360 mA)	15.6 W (450 mA)	18.7 W (540 mA)	24.9 W (720 mA)	31.1 W (900 mA)	37.4 W (1080 mA)	56.1 W (1080 mA)	84.2 W (1620 mA)	
Max.	8.6 W (230 mA)	17.2 W (460 mA)	25.9 W (690 mA)	34.5 W (920 mA)	43.1 W (1150 mA)	51.8 W (1380 mA)	69 W (1840 mA)	86.2 W (2300 mA)	103.5 W (2760 mA)	143.4 W (2760 mA)	215 W (4140 mA)	
Size	13.5mm x 13.5mm			19mm x 19mm				28mm x 28mm				

Color Variation

* CRI: Minimum

Product	CRI95+					CRI90+					CRI80+						CRI70+			
	2700K	3000K	3500K	4000K	5000K	2700K	3000K	3500K	4000K	5000K	2700K	3000K	3500K	4000K	5000K	5700K	6500K	3000K	4000K	5000K
LC003D Gen2						0	0	0	0	0	0	0	0	0	0	0	0			
LC006D Gen2						0	0	0	0	0	0	0	0	0	0	0	0			
LC009D Gen2						0	0	0	0	0	0	0	0	0	0	0	0	0	0	0
LC013D Gen2	0	0	0	0	0	0	0	0	0	0	0	0	0	0	0	0	0	0	0	0
LC016D Gen2	0	0	0	0	0	0	0	0	0	0	0	0	0	0	0	0	0	0	0	0
LC019D Gen2	0	0	0	0	0	0	0	0	0	0	0	0	0	0	0	0	0	0	0	0
LC026D Gen2	0	0	0	0	0	0	0	0	0	0	0	0	0	0	0	0	0	0	0	0
LC033D Gen2	0	0	0	0	0	0	0	0	0	0	0	0	0	0	0	0	0	0	0	0
LC040D Gen2	0	0	0	0	0	0	0	0	0	0	0	0	0	0	0	0	0	0	0	0
LC060D Gen2						0	0	0	0	0	0	0	0	0	0	0	0	0	0	0
LC080D Gen2						0	0	0	0	0	0	0	0	0	0	0	0	0	0	0
MacAdam 2-Step	0	0	0	0		0	0	0	0		0	0	0	0						
MacAdam 3-Step	0	0	0	0	0	0	0	0	0	0	0	0	0	0	0	0	0	0	0	0

Specifications

Product	CRI	CCT (K)	Color Rank	Part Number	T _j = 85°C		I _F (mA) V _F (V)		
					Luminous Flux Typ. (lm)	Luminous Efficacy Typ. (lm/W)			
 LC003D Gen 2	80+	2700	MacAdam 2step	SPHWAHDNA25YZW2D2	459	147	90mA 34.6V		
			MacAdam 3step	SPHWAHDNA25YZW3D2					
		3000	MacAdam 2step	SPHWAHDNA25YZV2D2	483	155			
			MacAdam 3step	SPHWAHDNA25YZV3D2					
		3500	MacAdam 2step	SPHWAHDNA25YZU2D2	501	161			
			MacAdam 3step	SPHWAHDNA25YZU3D2					
		4000	MacAdam 2step	SPHWAHDNA25YZT2D2	507	163			
			MacAdam 3step	SPHWAHDNA25YZT3D2					
		5000	MacAdam 3step	SPHWAHDNA25YZR3D2	513	165			
		5700	MacAdam 3step	SPHWAHDNA25YZQ3D2	513	165			
		6500	MacAdam 3step	SPHWAHDNA25YZP3D2	507	163			
		 LC006D Gen 2	90+	2700	MacAdam 2step	SPHWAHDNA27YZW2D2		388	125
					MacAdam 3step	SPHWAHDNA27YZW3D2			
				3000	MacAdam 2step	SPHWAHDNA27YZV2D2		406	130
MacAdam 3step	SPHWAHDNA27YZV3D2								
3500	MacAdam 2step			SPHWAHDNA27YZU2D2	419	135			
	MacAdam 3step			SPHWAHDNA27YZU3D2					
4000	MacAdam 2step			SPHWAHDNA27YZT2D2	427	137			
	MacAdam 3step			SPHWAHDNA27YZT3D2					
5000	MacAdam 3step			SPHWAHDNA27YZR3D2	430	138			
 LC006D Gen 2	80+			2700	MacAdam 2step	SPHWAHDNB25YZW2D2	924	148	180mA 34.6V
		MacAdam 3step	SPHWAHDNB25YZW3D2						
		3000	MacAdam 2step	SPHWAHDNB25YZV2D2	971	156			
			MacAdam 3step	SPHWAHDNB25YZV3D2					
		3500	MacAdam 2step	SPHWAHDNB25YZU2D2	1001	161			
			MacAdam 3step	SPHWAHDNB25YZU3D2					
		4000	MacAdam 2step	SPHWAHDNB25YZT2D2	1024	164			
			MacAdam 3step	SPHWAHDNB25YZT3D2					
		5000	MacAdam 3step	SPHWAHDNB25YZR3D2	1030	165			
		5700	MacAdam 3step	SPHWAHDNB25YZQ3D2	1030	165			
		6500	MacAdam 3step	SPHWAHDNB25YZP3D2	1018	163			
		 LC006D Gen 2	90+	2700	MacAdam 2step	SPHWAHDNB27YZW2D2	786	126	
					MacAdam 3step	SPHWAHDNB27YZW3D2			
				3000	MacAdam 2step	SPHWAHDNB27YZV2D2	824	132	
MacAdam 3step	SPHWAHDNB27YZV3D2								
3500	MacAdam 2step			SPHWAHDNB27YZU2D2	853	137			
	MacAdam 3step			SPHWAHDNB27YZU3D2					
4000	MacAdam 2step			SPHWAHDNB27YZT2D2	870	140			
	MacAdam 3step			SPHWAHDNB27YZT3D2					
5000	MacAdam 3step	SPHWAHDNB27YZR3D2	874	140					

Specifications

D-series

Product	CRI	CCT (K)	Color Rank	Part Number	T _j = 85°C		I _f (mA) V _F (V)
					Luminous Flux Typ. (lm)	Luminous Efficacy Typ. (lm/W)	
 LC009D Gen 2	70+	3000	MacAdam 3step	SPHWAHDNC23YZV3D2	1578	161	270mA 34.6V
		4000	MacAdam 3step	SPHWAHDNC23YZT3D2	1654	169	
		5000	MacAdam 3step	SPHWAHDNC23YZR3D2	1707	174	
	80+	2700	MacAdam 2step	SPHWAHDNC25YZW2D2	1342	144	
			MacAdam 3step	SPHWAHDNC25YZW3D2			
		3000	MacAdam 2step	SPHWAHDNC25YZV2D2	1418	152	
			MacAdam 3step	SPHWAHDNC25YZV3D2			
		3500	MacAdam 2step	SPHWAHDNC25YZU2D2	1459	156	
			MacAdam 3step	SPHWAHDNC25YZU3D2			
		4000	MacAdam 2step	SPHWAHDNC25YZT2D2	1494	160	
			MacAdam 3step	SPHWAHDNC25YZT3D2			
		5000	MacAdam 3step	SPHWAHDNC25YZR3D2	1506	161	
	5700	MacAdam 3step	SPHWAHDNC25YZQ3D2	1506	161		
	6500	MacAdam 3step	SPHWAHDNC25YZP3D2	1488	159		
	90+	2700	MacAdam 2step	SPHWAHDNC27YZW2D2	1152	123	
			MacAdam 3step	SPHWAHDNC27YZW3D2			
		3000	MacAdam 2step	SPHWAHDNC27YZV2D2	1206	129	
			MacAdam 3step	SPHWAHDNC27YZV3D2			
3500		MacAdam 2step	SPHWAHDNC27YZU2D2	1245	133		
		MacAdam 3step	SPHWAHDNC27YZU3D2				
4000		MacAdam 2step	SPHWAHDNC27YZT2D2	1273	136		
		MacAdam 3step	SPHWAHDNC27YZT3D2				
5000		MacAdam 3step	SPHWAHDNC27YZR3D2	1278	137		
70+	3000	MacAdam 3step	SPHWAHDND23YZV3D2	2106	161	360mA 34.6V	
		MacAdam 3step	SPHWAHDND23YZT3D2	2173	166		
		MacAdam 3step	SPHWAHDND23YZR3D2	2207	169		
	80+	2700	MacAdam 2step	SPHWAHDND25YZW2D2	1764		142
			MacAdam 3step	SPHWAHDND25YZW3D2			
		3000	MacAdam 2step	SPHWAHDND25YZV2D2	1857		149
			MacAdam 3step	SPHWAHDND25YZV3D2			
		3500	MacAdam 2step	SPHWAHDND25YZU2D2	1915		154
			MacAdam 3step	SPHWAHDND25YZU3D2			
		4000	MacAdam 2step	SPHWAHDND25YZT2D2	1950		157
			MacAdam 3step	SPHWAHDND25YZT3D2			
		5000	MacAdam 3step	SPHWAHDND25YZR3D2	1967		158
	5700	MacAdam 3step	SPHWAHDND25YZQ3D2	1967	158		
	6500	MacAdam 3step	SPHWAHDND25YZP3D2	1938	156		
	90+	2700	MacAdam 2step	SPHWAHDND27YZW2D2	1509		121
			MacAdam 3step	SPHWAHDND27YZW3D2			
		3000	MacAdam 2step	SPHWAHDND27YZV2D2	1580		127
			MacAdam 3step	SPHWAHDND27YZV3D2			
3500		MacAdam 2step	SPHWAHDND27YZU2D2	1635	131		
		MacAdam 3step	SPHWAHDND27YZU3D2				
4000		MacAdam 2step	SPHWAHDND27YZT2D2	1670	134		
		MacAdam 3step	SPHWAHDND27YZT3D2				
5000		MacAdam 3step	SPHWAHDND27YZR3D2	1674	134		

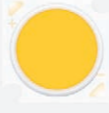
Product	CRI	CCT (K)	Color Rank	Part Number	T _j = 85°C		I _f (mA) V _F (V)
					Luminous Flux Typ. (lm)	Luminous Efficacy Typ. (lm/W)	
 LC013D Gen 2	95+	2700	MacAdam 2step	SPHWAHDND28YZW2D2	1223	98	360mA 34.6V
			MacAdam 3step	SPHWAHDND28YZW3D2			
		3000	MacAdam 2step	SPHWAHDND28YZV2D2	1285	103	
			MacAdam 3step	SPHWAHDND28YZV3D2			
		3500	MacAdam 2step	SPHWAHDND28YZU2D2	1337	107	
			MacAdam 3step	SPHWAHDND28YZU3D2			
	4000	MacAdam 2step	SPHWAHDND28YZT2D2	1379	111		
		MacAdam 3step	SPHWAHDND28YZT3D2				
	70+	3000	MacAdam 3step	SPHWAHDNE23YZV3D2	2617	168	
			MacAdam 3step	SPHWAHDNE23YZT3D2	2701	173	
			MacAdam 3step	SPHWAHDNE23YZR3D2	2742	176	
		2700	MacAdam 2step	SPHWAHDNE25YZW2D2	2293	147	
MacAdam 3step			SPHWAHDNE25YZW3D2				
MacAdam 2step			SPHWAHDNE25YZV2D2	2423	156		
80+	3000	MacAdam 3step	SPHWAHDNE25YZV3D2				
		MacAdam 2step	SPHWAHDNE25YZU2D2	2513	161		
	3500	MacAdam 3step	SPHWAHDNE25YZU3D2				
		MacAdam 2step	SPHWAHDNE25YZT2D2	2558	164		
	4000	MacAdam 3step	SPHWAHDNE25YZT3D2				
		MacAdam 2step	SPHWAHDNE25YZR3D2	2581	166		
	5000	MacAdam 3step	SPHWAHDNE25YZQ3D2	2581	166		
		MacAdam 3step	SPHWAHDNE25YZP3D2	2558	164		
	90+	90+	2700	MacAdam 2step	SPHWAHDNE27YZW2D2	1967	126
MacAdam 3step				SPHWAHDNE27YZW3D2			
3000			MacAdam 2step	SPHWAHDNE27YZV2D2	2084	134	
			MacAdam 3step	SPHWAHDNE27YZV3D2			
3500			MacAdam 2step	SPHWAHDNE27YZU2D2	2146	138	
			MacAdam 3step	SPHWAHDNE27YZU3D2			
4000		MacAdam 2step	SPHWAHDNE27YZT2D2	2189	141		
		MacAdam 3step	SPHWAHDNE27YZT3D2				
95+		5000	MacAdam 3step	SPHWAHDNE27YZR3D2	2209	142	
			MacAdam 2step	SPHWAHDNE28YZW2D2	1575	101	
			MacAdam 3step	SPHWAHDNE28YZW3D2			
		3000	MacAdam 2step	SPHWAHDNE28YZV2D2	1655	106	
	MacAdam 3step		SPHWAHDNE28YZV3D2				
	3500	MacAdam 2step	SPHWAHDNE28YZU2D2	1722	111		
MacAdam 3step		SPHWAHDNE28YZU3D2					
4000	MacAdam 2step	SPHWAHDNE28YZT2D2	1776	114			
	MacAdam 3step	SPHWAHDNE28YZT3D2					
5000	MacAdam 3step	SPHWAHDNE28YZR3D2	1791	115			

D-series

Specifications

D-series

Product	CRI	CCT (K)	Color Rank	Part Number	T _j = 85°C		I _F (mA) V _F (V)
					Luminous Flux Typ. (lm)	Luminous Efficacy Typ. (lm/W)	
 LC019D Gen 2	70+	3000	MacAdam 3step	SPHWAHDNF23YZV3D2	3107	166	540mA 34.6V
		4000	MacAdam 3step	SPHWAHDNF23YZT3D2	3207	172	
		5000	MacAdam 3step	SPHWAHDNF23YZR3D2	3256	174	
	80+	2700	MacAdam 2step	SPHWAHDNF25YZW2D2	2728	146	
			MacAdam 3step	SPHWAHDNF25YZW3D2			
		3000	MacAdam 2step	SPHWAHDNF25YZV2D2	2877	154	
			MacAdam 3step	SPHWAHDNF25YZV3D2			
		3500	MacAdam 2step	SPHWAHDNF25YZU2D2	2965	159	
			MacAdam 3step	SPHWAHDNF25YZU3D2			
		4000	MacAdam 2step	SPHWAHDNF25YZT2D2	3026	162	
			MacAdam 3step	SPHWAHDNF25YZT3D2			
		5000	MacAdam 2step	SPHWAHDNF25YZR3D2	3059	164	
			MacAdam 3step	SPHWAHDNF25YZR3D2			
	5700	MacAdam 2step	SPHWAHDNF25YZQ3D2	3059	164		
		MacAdam 3step	SPHWAHDNF25YZQ3D2				
	6500	MacAdam 2step	SPHWAHDNF25YZP3D2	3026	162		
		MacAdam 3step	SPHWAHDNF25YZP3D2				
	90+	2700	MacAdam 2step	SPHWAHDNF27YZW2D2	2336	125	
			MacAdam 3step	SPHWAHDNF27YZW3D2			
		3000	MacAdam 2step	SPHWAHDNF27YZV2D2	2449	131	
			MacAdam 3step	SPHWAHDNF27YZV3D2			
		3500	MacAdam 2step	SPHWAHDNF27YZU2D2	2539	136	
			MacAdam 3step	SPHWAHDNF27YZU3D2			
		4000	MacAdam 2step	SPHWAHDNF27YZT2D2	2594	139	
			MacAdam 3step	SPHWAHDNF27YZT3D2			
		5000	MacAdam 2step	SPHWAHDNF27YZR3D2	2596	139	
			MacAdam 3step	SPHWAHDNF27YZR3D2			
95+	2700	MacAdam 2step	SPHWAHDNF28YZW2D2	1880	101		
		MacAdam 3step	SPHWAHDNF28YZW3D2				
	3000	MacAdam 2step	SPHWAHDNF28YZV2D2	1976	106		
		MacAdam 3step	SPHWAHDNF28YZV3D2				
	3500	MacAdam 2step	SPHWAHDNF28YZU2D2	2056	110		
		MacAdam 3step	SPHWAHDNF28YZU3D2				
	4000	MacAdam 2step	SPHWAHDNF28YZT2D2	2121	114		
		MacAdam 3step	SPHWAHDNF28YZT3D2				
	5000	MacAdam 2step	SPHWAHDNF28YZR3D2	2138	114		
		MacAdam 3step	SPHWAHDNF28YZR3D2				
70+	3000	MacAdam 3step	SPHWAHDNG23YZV3D2	4063	163		
		MacAdam 3step	SPHWAHDNG23YZT3D2				
		MacAdam 3step	SPHWAHDNG23YZR3D2				
	2700	MacAdam 2step	SPHWAHDNG25YZW2D2	3580	144		
		MacAdam 3step	SPHWAHDNG25YZW3D2				
	3000	MacAdam 2step	SPHWAHDNG25YZV2D2	3762	151		
		MacAdam 3step	SPHWAHDNG25YZV3D2				
	3500	MacAdam 2step	SPHWAHDNG25YZU2D2	3872	155		
		MacAdam 3step	SPHWAHDNG25YZU3D2				
	4000	MacAdam 2step	SPHWAHDNG25YZT2D2	3950	159		
MacAdam 3step		SPHWAHDNG25YZT3D2					
5000	MacAdam 2step	SPHWAHDNG25YZR3D2	3983	160			
	MacAdam 3step	SPHWAHDNG25YZR3D2					
5700	MacAdam 2step	SPHWAHDNG25YZQ3D2	3983	160			
	MacAdam 3step	SPHWAHDNG25YZQ3D2					
6500	MacAdam 2step	SPHWAHDNG25YZP3D2	3950	159			
	MacAdam 3step	SPHWAHDNG25YZP3D2					



LC026D Gen 2

Product	CRI	CCT (K)	Color Rank	Part Number	T _j = 85°C		I _F (mA) V _F (V)
					Luminous Flux Typ. (lm)	Luminous Efficacy Typ. (lm/W)	
 LC026D Gen 2	90+	2700	MacAdam 2step	SPHWAHDNG27YZW2D2	3064	123	720mA 34.6V
			MacAdam 3step	SPHWAHDNG27YZW3D2			
		3000	MacAdam 2step	SPHWAHDNG27YZV2D2	3223	129	
			MacAdam 3step	SPHWAHDNG27YZV3D2			
		3500	MacAdam 2step	SPHWAHDNG27YZU2D2	3319	133	
			MacAdam 3step	SPHWAHDNG27YZU3D2			
		4000	MacAdam 2step	SPHWAHDNG27YZT2D2	3387	136	
			MacAdam 3step	SPHWAHDNG27YZT3D2			
		5000	MacAdam 2step	SPHWAHDNG27YZR3D2	3416	137	
			MacAdam 3step	SPHWAHDNG27YZR3D2			
	95+	2700	MacAdam 2step	SPHWAHDNG28YZW2D2	2470	99	
			MacAdam 3step	SPHWAHDNG28YZW3D2			
		3000	MacAdam 2step	SPHWAHDNG28YZV2D2	2596	104	
			MacAdam 3step	SPHWAHDNG28YZV3D2			
		3500	MacAdam 2step	SPHWAHDNG28YZU2D2	2701	108	
			MacAdam 3step	SPHWAHDNG28YZU3D2			
		4000	MacAdam 2step	SPHWAHDNG28YZT2D2	2786	112	
			MacAdam 3step	SPHWAHDNG28YZT3D2			
		5000	MacAdam 2step	SPHWAHDNG28YZR3D2	2809	113	
			MacAdam 3step	SPHWAHDNG28YZR3D2			
	70+	3000	MacAdam 3step	SPHWAHDNH23YZV3D2	5014	161	
			MacAdam 3step	SPHWAHDNH23YZT3D2			
			MacAdam 3step	SPHWAHDNH23YZR3D2			
		2700	MacAdam 2step	SPHWAHDNH25YZW2D2	4418	142	
			MacAdam 3step	SPHWAHDNH25YZW3D2			
		3000	MacAdam 2step	SPHWAHDNH25YZV2D2	4643	149	
			MacAdam 3step	SPHWAHDNH25YZV3D2			
3500		MacAdam 2step	SPHWAHDNH25YZU2D2	4779	153		
		MacAdam 3step	SPHWAHDNH25YZU3D2				
4000		MacAdam 2step	SPHWAHDNH25YZT2D2	4875	157		
	MacAdam 3step	SPHWAHDNH25YZT3D2					
5000	MacAdam 2step	SPHWAHDNH25YZR3D2	4916	158			
	MacAdam 3step	SPHWAHDNH25YZR3D2					
5700	MacAdam 2step	SPHWAHDNH25YZQ3D2	4916	158			
	MacAdam 3step	SPHWAHDNH25YZQ3D2					
6500	MacAdam 2step	SPHWAHDNH25YZP3D2	4875	157			
	MacAdam 3step	SPHWAHDNH25YZP3D2					
90+	2700	MacAdam 2step	SPHWAHDNH27YZW2D2	3781	121		
		MacAdam 3step	SPHWAHDNH27YZW3D2				
	3000	MacAdam 2step	SPHWAHDNH27YZV2D2	3977	128		
		MacAdam 3step	SPHWAHDNH27YZV3D2				
	3500	MacAdam 2step	SPHWAHDNH27YZU2D2	4096	132		
		MacAdam 3step	SPHWAHDNH27YZU3D2				
	4000	MacAdam 2step	SPHWAHDNH27YZT2D2	4180	134		
		MacAdam 3step	SPHWAHDNH27YZT3D2				
	5000	MacAdam 2step	SPHWAHDNH27YZR3D2	4216	135		
		MacAdam 3step	SPHWAHDNH27YZR3D2				
95+	2700	MacAdam 2step	SPHWAHDNH28YZW2D2	3057	98		
		MacAdam 3step	SPHWAHDNH28YZW3D2				
	3000	MacAdam 2step	SPHWAHDNH28YZV2D2	3212	103		
		MacAdam 3step	SPHWAHDNH28YZV3D2				
	3500	MacAdam 2step	SPHWAHDNH28YZU2D2	3343	107		
		MacAdam 3step	SPHWAHDNH28YZU3D2				
	4000	MacAdam 2step	SPHWAHDNH28YZT2D2	3447	111		
		MacAdam 3step	SPHWAHDNH28YZT3D2				
	5000	MacAdam 2step	SPHWAHDNH28YZR3D2	3476	112		
		MacAdam 3step	SPHWAHDNH28YZR3D2				



LC033D Gen 2

D-series

Specifications

D-series

Product	CRI	CCT (K)	Color Rank	Part Number	T _j = 85°C		I _F (mA) V _F (V)
					Luminous Flux Typ. (lm)	Luminous Efficacy Typ. (lm/W)	
 LC040D Gen 2	70+	3000	MacAdam 3step	SPHWAHDNK23YZV3D2	6304	169	1080mA 34.6V
		4000	MacAdam 3step	SPHWAHDNK23YZT3D2	6506	174	
		5000	MacAdam 3step	SPHWAHDNK23YZR3D2	6607	177	
	80+	2700	MacAdam 2step	SPHWAHDNK25YZW2D2	5547	148	
			MacAdam 3step	SPHWAHDNK25YZW3D2			
		3000	MacAdam 2step	SPHWAHDNK25YZV2D2	5837	156	
			MacAdam 3step	SPHWAHDNK25YZV3D2			
		3500	MacAdam 2step	SPHWAHDNK25YZU2D2	6016	161	
			MacAdam 3step	SPHWAHDNK25YZU3D2			
		4000	MacAdam 2step	SPHWAHDNK25YZT2D2	6146	164	
			MacAdam 3step	SPHWAHDNK25YZT3D2			
		5000	MacAdam 3step	SPHWAHDNK25YZR3D2	6175	165	
			MacAdam 3step	SPHWAHDNK25YZQ3D2	6205	166	
		6500	MacAdam 3step	SPHWAHDNK25YZP3D2	6138	164	
	90+	2700	MacAdam 2step	SPHWAHDNK27YZW2D2	4755	127	
			MacAdam 3step	SPHWAHDNK27YZW3D2			
		3000	MacAdam 2step	SPHWAHDNK27YZV2D2	5024	134	
			MacAdam 3step	SPHWAHDNK27YZV3D2			
		3500	MacAdam 2step	SPHWAHDNK27YZU2D2	5152	138	
			MacAdam 3step	SPHWAHDNK27YZU3D2			
		4000	MacAdam 2step	SPHWAHDNK27YZT2D2	5266	141	
			MacAdam 3step	SPHWAHDNK27YZT3D2			
		5000	MacAdam 3step	SPHWAHDNK27YZR3D2	5325	143	
95+		2700	MacAdam 2step	SPHWAHDNK28YZW2D2	3760	101	
			MacAdam 3step	SPHWAHDNK28YZW3D2			
	3000	MacAdam 2step	SPHWAHDNK28YZV2D2	3952	106		
		MacAdam 3step	SPHWAHDNK28YZV3D2				
	3500	MacAdam 2step	SPHWAHDNK28YZU2D2	4113	110		
		MacAdam 3step	SPHWAHDNK28YZU3D2				
	4000	MacAdam 2step	SPHWAHDNK28YZT2D2	4241	113		
		MacAdam 3step	SPHWAHDNK28YZT3D2				
	5000	MacAdam 3step	SPHWAHDNK28YZR3D2	4277	114		
	70+	3000	MacAdam 3step	SPHWAHDNL231ZV3D2	9225	164	1080mA 52V
			MacAdam 3step	SPHWAHDNL231ZT3D2	9521	170	
MacAdam 3step			SPHWAHDNL231ZR3D2	9668	172		
2700		MacAdam 2step	SPHWAHDNL251ZW2D2	8107	144		
		MacAdam 3step	SPHWAHDNL251ZW3D2				
3000		MacAdam 2step	SPHWAHDNL251ZV2D2	8542	152		
		MacAdam 3step	SPHWAHDNL251ZV3D2				
3500		MacAdam 2step	SPHWAHDNL251ZU2D2	8812	157		
		MacAdam 3step	SPHWAHDNL251ZU3D2				
4000		MacAdam 2step	SPHWAHDNL251ZT2D2	8995	160		
		MacAdam 3step	SPHWAHDNL251ZT3D2				
5000		MacAdam 3step	SPHWAHDNL251ZR3D2	9039	161		
		MacAdam 3step	SPHWAHDNL251ZQ3D2	9084	162		
6500		MacAdam 3step	SPHWAHDNL251ZP3D2	8990	160		

Product	CRI	CCT (K)	Color Rank	Part Number	T _j = 85°C		I _F (mA) V _F (V)	
					Luminous Flux Typ. (lm)	Luminous Efficacy Typ. (lm/W)		
 LC060D Gen 2	90+	2700	MacAdam 2step	SPHWAHDNL271ZW2D2	6959	124	1080mA 52V	
			MacAdam 3step	SPHWAHDNL271ZW3D2				
		3000	MacAdam 2step	SPHWAHDNL271ZV2D2	7352	131		
			MacAdam 3step	SPHWAHDNL271ZV3D2				
		3500	MacAdam 2step	SPHWAHDNL271ZU2D2	7539	134		
			MacAdam 3step	SPHWAHDNL271ZU3D2				
	4000	MacAdam 2step	SPHWAHDNL271ZT2D2	7706	137			
		MacAdam 3step	SPHWAHDNL271ZT3D2					
	70+	3000	MacAdam 3step	SPHWAHDNM231ZV3D2	13465	160		1620mA 52V
			MacAdam 3step	SPHWAHDNM231ZT3D2	13896	165		
			MacAdam 3step	SPHWAHDNM231ZR3D2	14112	168		
		2700	MacAdam 2step	SPHWAHDNM251ZW2D2	11815	140		
MacAdam 3step			SPHWAHDNM251ZW3D2					
3000		MacAdam 2step	SPHWAHDNM251ZV2D2	12468	148			
	MacAdam 3step	SPHWAHDNM251ZV3D2						
80+	3500	MacAdam 2step	SPHWAHDNM251ZU2D2	12852	153			
		MacAdam 3step	SPHWAHDNM251ZU3D2					
	4000	MacAdam 2step	SPHWAHDNM251ZT2D2	13123	156			
		MacAdam 3step	SPHWAHDNM251ZT3D2					
	5000	MacAdam 3step	SPHWAHDNM251ZR3D2	13196	157			
		MacAdam 3step	SPHWAHDNM251ZQ3D2	13258	157			
6500	MacAdam 3step	SPHWAHDNM251ZP3D2	13121	156				
90+	2700	MacAdam 2step	SPHWAHDNM271ZW2D2	10157	121	1080mA 52V		
		MacAdam 3step	SPHWAHDNM271ZW3D2					
		3000	MacAdam 2step	SPHWAHDNM271ZV2D2	10731		127	
			MacAdam 3step	SPHWAHDNM271ZV3D2				
	3500	MacAdam 2step	SPHWAHDNM271ZU2D2	11004	131			
		MacAdam 3step	SPHWAHDNM271ZU3D2					
	4000	MacAdam 2step	SPHWAHDNM271ZT2D2	11247	134			
		MacAdam 3step	SPHWAHDNM271ZT3D2					
	5000	MacAdam 3step	SPHWAHDNM271ZR3D2	11375	135			

D-series



D-series Gen 1

T _j =85°C	LC003D Gen1	LC006D Gen1	LC009D Gen1	LC013D Gen1	LC016D Gen1	LC019D Gen1	LC026D Gen1	LC040D Gen1	LC060D Gen1	LC080D Gen1
LES	9.8mm			14.5mm			22mm			
Typical	34.6 V								52 V	
	3.1 W (90 mA)	6.2 W (180 mA)	9.4 W (270 mA)	12.5 W (360 mA)	15.6 W (450 mA)	18.7 W (540 mA)	24.9 W (720 mA)	37.4 W (1080 mA)	56.1 W (1080 mA)	84.2 W (1620 mA)
Max.	8.6 W (230 mA)	17.2 W (460 mA)	25.9 W (690 mA)	34.5 W (920 mA)	43.1 W (1150 mA)	51.8 W (1380 mA)	69 W (1840 mA)	103.5 W (2760 mA)	143.4 W (2760 mA)	215 W (2760 mA)
Size	13.5 x 13.5mm			19 x 19mm			28 x 28mm			

Color Variation

* CRI: Minimum

Product	CRI90+					CRI80+							CRI70+		
	2700K	3000K	3500K	4000K	5000K	2700K	3000K	3500K	4000K	5000K	5700K	6500K	3000K	4000K	5000K
LC003D Gen1	o	o	o	o	o	o	o	o	o	o	o	o			
LC006D Gen1	o	o	o	o	o	o	o	o	o	o	o	o			
LC009D Gen1	o	o	o	o	o	o	o	o	o	o	o	o			
LC013D Gen1	o	o	o	o	o	o	o	o	o	o	o	o			
LC016D Gen1	o	o	o	o	o	o	o	o	o	o	o	o			
LC019D Gen1	o	o	o	o	o	o	o	o	o	o	o	o			
LC026D Gen1	o	o	o	o	o	o	o	o	o	o	o	o			
LC040D Gen1	o	o	o	o	o	o	o	o	o	o	o	o			
LC060D Gen1						o	o	o	o	o	o	o	o	o	o
LC080D Gen1						o	o	o	o	o	o	o	o	o	o
MacAdam 2-Step	o	o	o	o	o	o	o	o	o						
MacAdam 3-Step	o	o	o	o	o	o	o	o	o	o	o	o	o	o	o

Specifications

Product	CRI	CCT (K)	Color Rank	Part Number	T _j = 85°C		I _F (mA) V _F (V)	
					Luminous Flux Typ. (lm)	Luminous Efficacy Typ. (lm/W)		
LC003D Gen1	80+	2700	MacAdam 2step	SPHWAHDNA25YZW2A9	413	133	90mA 34.6V	
			MacAdam 3step	SPHWAHDNA25YZW3A9				
			MacAdam 2step	SPHWAHDNA25YZW2D1	434	139		
			MacAdam 3step	SPHWAHDNA25YZW3D1				
			3000	MacAdam 2step	SPHWAHDNA25YZV2B1	435		140
				MacAdam 3step	SPHWAHDNA25YZV3B1			
		MacAdam 2step		SPHWAHDNA25YZV2D1	457	147		
		MacAdam 3step		SPHWAHDNA25YZV3D1				
		3500	MacAdam 2step	SPHWAHDNA25YZU2B2	451	145		
			MacAdam 3step	SPHWAHDNA25YZU3B2				
			MacAdam 2step	SPHWAHDNA25YZU2D1	474	152		
		MacAdam 3step	SPHWAHDNA25YZU3D1					
		4000	MacAdam 2step	SPHWAHDNA25YZT2B3	457	147		
			MacAdam 3step	SPHWAHDNA25YZT3B3				
			MacAdam 2step	SPHWAHDNA25YZT2D1	480	154		
		MacAdam 3step	SPHWAHDNA25YZT3D1					
		5000	MacAdam 3step	SPHWAHDNA25YZR3B3	462	148		
				SPHWAHDNA25YZR3D1	485	156		
		5700	MacAdam 3step	SPHWAHDNA25YZQ3B3	462	148		
				SPHWAHDNA25YZQ3D1	485	156		
		6500	MacAdam 3step	SPHWAHDNA25YZP3B3	457	147		
				SPHWAHDNA25YZP3D1	480	154		
		90+	2700	MacAdam 2step	SPHWAHDNA27YZW2A3	349		112
				MacAdam 3step	SPHWAHDNA27YZW3A3			
MacAdam 2step	SPHWAHDNA27YZW2D1			367	118			
MacAdam 3step	SPHWAHDNA27YZW3D1							
3000	MacAdam 2step			SPHWAHDNA27YZV2A4	365	117		
	MacAdam 3step			SPHWAHDNA27YZV3A4				
	MacAdam 2step		SPHWAHDNA27YZV2D1	384	123			
MacAdam 3step	SPHWAHDNA27YZV3D1							
3500	MacAdam 2step		SPHWAHDNA27YZU2A5	377	121			
	MacAdam 3step		SPHWAHDNA27YZU3A5					
	MacAdam 2step		SPHWAHDNA27YZU2D1	396	127			
	MacAdam 3step		SPHWAHDNA27YZU3D1					
4000	MacAdam 2step		SPHWAHDNA27YZT2A6	385	124			
	MacAdam 3step		SPHWAHDNA27YZT3A6					
	MacAdam 2step		SPHWAHDNA27YZT2D1	404	130			
MacAdam 3step	SPHWAHDNA27YZT3D1							
5000	MacAdam 3step		SPHWAHDNA27YZR3A6	387	124			
			SPHWAHDNA27YZR3D1	407	131			

Specifications

D-series

Product	CRI	CCT (K)	Color Rank	Part Number	T _j = 85°C		I _F (mA) V _F (V)	
					Luminous Flux Typ. (lm)	Luminous Efficacy Typ. (lm/W)		
 LC006D Gen 1	80+	2700	MacAdam 2step	SPHWAHDNB25YZW2E9	832	134	180mA 34.6V	
			MacAdam 3step	SPHWAHDNB25YZW3E9				
			MacAdam 2step	SPHWAHDNB25YZW2D1				
			MacAdam 3step	SPHWAHDNB25YZW3D1				
		3000	MacAdam 2step	SPHWAHDNB25YZV2F3	875	140		
			MacAdam 3step	SPHWAHDNB25YZV3F3				
			MacAdam 2step	SPHWAHDNB25YZV2D1				
			MacAdam 3step	SPHWAHDNB25YZV3D1				
		3500	MacAdam 2step	SPHWAHDNB25YZU2F5	902	145		
			MacAdam 3step	SPHWAHDNB25YZU3F5				
			MacAdam 2step	SPHWAHDNB25YZU2D1				
			MacAdam 3step	SPHWAHDNB25YZU3D1				
		4000	MacAdam 2step	SPHWAHDNB25YZT2F8	923	148		
			MacAdam 3step	SPHWAHDNB25YZT3F8				
			MacAdam 2step	SPHWAHDNB25YZT2D1				
			MacAdam 3step	SPHWAHDNB25YZT3D1				
		5000	MacAdam 3step	SPHWAHDNB25YZR3F8	928	149		
				SPHWAHDNB25YZR3D1	975	157		
		5700	MacAdam 3step	SPHWAHDNB25YZQ3F8	928	149		
				SPHWAHDNB25YZQ3D1	975	157		
		6500	MacAdam 3step	SPHWAHDNB25YZP3F7	918	147		
				SPHWAHDNB25YZP3D1	964	155		
		90+	2700	MacAdam 2step	SPHWAHDNB27YZW2D7	709		114
				MacAdam 3step	SPHWAHDNB27YZW3D7			
				MacAdam 2step	SPHWAHDNB27YZW2D1			
				MacAdam 3step	SPHWAHDNB27YZW3D1			
			3000	MacAdam 2step	SPHWAHDNB27YZV2E9	743		119
				MacAdam 3step	SPHWAHDNB27YZV3E9			
				MacAdam 2step	SPHWAHDNB27YZV2D1			
			3000	MacAdam 3step	SPHWAHDNB27YZV3D1	780		125
				MacAdam 2step	SPHWAHDNB27YZU2E0			
				MacAdam 3step	SPHWAHDNB27YZU3E0			
3500	MacAdam 2step		SPHWAHDNB27YZU2D1	807	130			
	MacAdam 3step		SPHWAHDNB27YZU3D1					
	MacAdam 2step		SPHWAHDNB27YZT2E4					
	MacAdam 3step		SPHWAHDNB27YZT3E4					
4000	MacAdam 2step		SPHWAHDNB27YZT2D1	824	132			
	MacAdam 3step		SPHWAHDNB27YZT3D1					
	MacAdam 2step	SPHWAHDNB27YZR3E4						
	MacAdam 3step	SPHWAHDNB27YZR3D1						
5000	MacAdam 3step	SPHWAHDNB27YZR3E4	787	126				
		SPHWAHDNB27YZR3D1	827	133				

Product	CRI	CCT (K)	Color Rank	Part Number	T _j = 85°C		I _F (mA) V _F (V)	
					Luminous Flux Typ. (lm)	Luminous Efficacy Typ. (lm/W)		
 LC009D Gen 1	80+	2700	MacAdam 2step	SPHWAHDNC25YZW2H1	1209	129	270mA 34.6V	
			MacAdam 3step	SPHWAHDNC25YZW3H1				
			MacAdam 2step	SPHWAHDNC25YZW2D1				
			MacAdam 3step	SPHWAHDNC25YZW3D1				
		3000	MacAdam 2step	SPHWAHDNC25YZV2H2	1278	137		
			MacAdam 3step	SPHWAHDNC25YZV3H2				
			MacAdam 2step	SPHWAHDNC25YZV2D1				
			MacAdam 3step	SPHWAHDNC25YZV3D1				
		3500	MacAdam 2step	SPHWAHDNC25YZU2H2	1315	141		
			MacAdam 3step	SPHWAHDNC25YZU3H2				
			MacAdam 2step	SPHWAHDNC25YZU2D1				
			MacAdam 3step	SPHWAHDNC25YZU3D1				
		4000	MacAdam 2step	SPHWAHDNC25YZT2H2	1347	144		
			MacAdam 3step	SPHWAHDNC25YZT3H2				
			MacAdam 2step	SPHWAHDNC25YZT2D1				
			MacAdam 3step	SPHWAHDNC25YZT3D1				
		5000	MacAdam 3step	SPHWAHDNC25YZR3H2	1357	145		
				SPHWAHDNC25YZR3D1	1425	153		
		5700	MacAdam 3step	SPHWAHDNC25YZQ3H2	1357	145		
				SPHWAHDNC25YZQ3D1	1425	153		
		6500	MacAdam 3step	SPHWAHDNC25YZP3H2	1341	144		
				SPHWAHDNC25YZP3D1	1408	151		
		90+	2700	MacAdam 2step	SPHWAHDNC27YZW2G8	1038		111
				MacAdam 3step	SPHWAHDNC27YZW3G8			
				MacAdam 2step	SPHWAHDNC27YZW2D1			
				MacAdam 3step	SPHWAHDNC27YZW3D1			
			3000	MacAdam 2step	SPHWAHDNC27YZV2H0	1087		116
				MacAdam 3step	SPHWAHDNC27YZV3H0			
				MacAdam 2step	SPHWAHDNC27YZV2D1			
			3000	MacAdam 3step	SPHWAHDNC27YZV3D1	1141		122
				MacAdam 2step	SPHWAHDNC27YZU2H0			
				MacAdam 3step	SPHWAHDNC27YZU3H0			
3500	MacAdam 2step		SPHWAHDNC27YZU2D1	1178	126			
	MacAdam 3step		SPHWAHDNC27YZU3D1					
	MacAdam 2step		SPHWAHDNC27YZT2H0					
	MacAdam 3step		SPHWAHDNC27YZT3H0					
4000	MacAdam 2step		SPHWAHDNC27YZT2D1	1204	129			
	MacAdam 3step		SPHWAHDNC27YZT3D1					
	MacAdam 2step	SPHWAHDNC27YZR3H1						
	MacAdam 3step	SPHWAHDNC27YZR3D1						
5000	MacAdam 3step	SPHWAHDNC27YZR3H1	1152	123				
		SPHWAHDNC27YZR3D1	1210	130				

D-series

Specifications

D-series

Product	CRI	CCT (K)	Color Rank	Part Number	T _j = 85°C		I _F (mA) V _F (V)	
					Luminous Flux Typ. (lm)	Luminous Efficacy Typ. (lm/W)		
 LC013D Gen 1	80+	2700	MacAdam 2step	SPHWAHDND25YZW2H5	1589	128	360mA 34.6V	
			MacAdam 3step	SPHWAHDND25YZW3H5				
			MacAdam 2step	SPHWAHDND25YZW2D1				
			MacAdam 3step	SPHWAHDND25YZW3D1				
		3000	MacAdam 2step	SPHWAHDND25YZV2H5	1673	134		
			MacAdam 3step	SPHWAHDND25YZV3H5				
			MacAdam 2step	SPHWAHDND25YZV2D1				
			MacAdam 3step	SPHWAHDND25YZV3D1				
		3500	MacAdam 2step	SPHWAHDND25YZU2H6	1725	138		
			MacAdam 3step	SPHWAHDND25YZU3H6				
			MacAdam 2step	SPHWAHDND25YZU2D1				
			MacAdam 3step	SPHWAHDND25YZU3D1				
		4000	MacAdam 2step	SPHWAHDND25YZT2H6	1757	141		
			MacAdam 3step	SPHWAHDND25YZT3H6				
			MacAdam 2step	SPHWAHDND25YZT2D1				
			MacAdam 3step	SPHWAHDND25YZT3D1				
		5000	MacAdam 3step	SPHWAHDND25YZR3H6	1772	142		
				SPHWAHDND25YZR3D1	1861	149		
		5700	MacAdam 3step	SPHWAHDND25YZQ3H6	1772	142		
				SPHWAHDND25YZQ3D1	1861	149		
		6500	MacAdam 3step	SPHWAHDND25YZP3H6	1746	140		
				SPHWAHDND25YZP3D1	1834	147		
		90+	2700	MacAdam 2step	SPHWAHDND27YZW2H2	1359		109
				MacAdam 3step	SPHWAHDND27YZW3H2			
	MacAdam 2step			SPHWAHDND27YZW2D1				
	MacAdam 3step			SPHWAHDND27YZW3D2				
	3000		MacAdam 2step	SPHWAHDND27YZV2H3	1423	114		
			MacAdam 3step	SPHWAHDND27YZV3H3				
			MacAdam 2step	SPHWAHDND27YZV2D1				
	3500		MacAdam 3step	SPHWAHDND27YZV3D1	1494	120		
			MacAdam 2step	SPHWAHDND27YZU2H4				
			MacAdam 3step	SPHWAHDND27YZU3H4				
4000	MacAdam 2step		SPHWAHDND27YZU2D1	1547	124			
	MacAdam 3step		SPHWAHDND27YZU3D1					
	MacAdam 2step		SPHWAHDND27YZT2H4					
	MacAdam 3step		SPHWAHDND27YZT3H4					
5000	MacAdam 2step		SPHWAHDND27YZT2D1	1580	127			
	MacAdam 3step		SPHWAHDND27YZT3D1					
	MacAdam 2step	SPHWAHDND27YZR3H4						
	MacAdam 3step	SPHWAHDND27YZR3D1						

Product	CRI	CCT (K)	Color Rank	Part Number	T _j = 85°C		I _F (mA) V _F (V)	
					Luminous Flux Typ. (lm)	Luminous Efficacy Typ. (lm/W)		
 LC016D Gen 1	80+	2700	MacAdam 2step	SPHWAHDNE25YZW2H9	2065	133	450mA 34.6V	
			MacAdam 3step	SPHWAHDNE25YZW3H9				
			MacAdam 2step	SPHWAHDNE25YZW2D1				
			MacAdam 3step	SPHWAHDNE25YZW3D1				
		3000	MacAdam 2step	SPHWAHDNE25YZV2J0	2182	140		
			MacAdam 3step	SPHWAHDNE25YZV3J0				
			MacAdam 2step	SPHWAHDNE25YZV2D1				
			MacAdam 3step	SPHWAHDNE25YZV3D1				
		3500	MacAdam 2step	SPHWAHDNE25YZU2J1	2263	145		
			MacAdam 3step	SPHWAHDNE25YZU3J1				
			MacAdam 2step	SPHWAHDNE25YZU2D1				
			MacAdam 3step	SPHWAHDNE25YZU3D1				
		4000	MacAdam 2step	SPHWAHDNE25YZT2J1	2304	148		
			MacAdam 3step	SPHWAHDNE25YZT3J1				
			MacAdam 2step	SPHWAHDNE25YZT2D1				
			MacAdam 3step	SPHWAHDNE25YZT3D1				
		5000	MacAdam 3step	SPHWAHDNE25YZR3J2	2324	149		
				SPHWAHDNE25YZR3D1	2440	157		
		5700	MacAdam 3step	SPHWAHDNE25YZQ3J2	2324	149		
				SPHWAHDNE25YZQ3D1	2440	157		
		6500	MacAdam 3step	SPHWAHDNE25YZP3J1	2304	148		
				SPHWAHDNE25YZP3D1	2419	155		
		90+	2700	MacAdam 2step	SPHWAHDNE27YZW2H6	1771		114
				MacAdam 3step	SPHWAHDNE27YZW3H6			
	MacAdam 2step			SPHWAHDNE27YZW2D1				
	MacAdam 3step			SPHWAHDNE27YZW3D1				
	3000		MacAdam 2step	SPHWAHDNE27YZV2H7	1877	121		
			MacAdam 3step	SPHWAHDNE27YZV3H7				
			MacAdam 2step	SPHWAHDNE27YZV2D1				
	3500		MacAdam 3step	SPHWAHDNE27YZV3D1	1970	127		
			MacAdam 2step	SPHWAHDNE27YZU2H8				
			MacAdam 3step	SPHWAHDNE27YZU3H8				
4000	MacAdam 2step		SPHWAHDNE27YZU2D1	2029	130			
	MacAdam 3step		SPHWAHDNE27YZU3D1					
	MacAdam 2step		SPHWAHDNE27YZT2H8					
	MacAdam 3step		SPHWAHDNE27YZT3H8					
5000	MacAdam 2step		SPHWAHDNE27YZT2D1	2069	133			
	MacAdam 3step		SPHWAHDNE27YZT3D1					
	MacAdam 2step	SPHWAHDNE27YZR3H8						
	MacAdam 3step	SPHWAHDNE27YZR3D1						

D-series

Specifications

D-series

Product	CRI	CCT (K)	Color Rank	Part Number	T _j = 85°C		I _F (mA) V _F (V)	
					Luminous Flux Typ. (lm)	Luminous Efficacy Typ. (lm/W)		
 LC019D Gen 1	80+	2700	MacAdam 2step	SPHWAHDNF25YZW2J3	2458	132	540mA 34.6V	
			MacAdam 3step	SPHWAHDNF25YZW3J3				
			MacAdam 2step	SPHWAHDNF25YZW2D1	2581	138		
			MacAdam 3step	SPHWAHDNF25YZW3D1				
		3000	MacAdam 2step	SPHWAHDNF25YZV24	2592	139		
			MacAdam 3step	SPHWAHDNF25YZV3J4				
			MacAdam 2step	SPHWAHDNF25YZV2D1	2722	146		
			MacAdam 3step	SPHWAHDNF25YZV3D1				
		3500	MacAdam 2step	SPHWAHDNF25YZU25	2672	143		
			MacAdam 3step	SPHWAHDNF25YZU3J5				
			MacAdam 2step	SPHWAHDNF25YZU2D1	2805	150		
			MacAdam 3step	SPHWAHDNF25YZU3D1				
		4000	MacAdam 2step	SPHWAHDNF25YZT25	2726	146		
			MacAdam 3step	SPHWAHDNF25YZT3J5				
			MacAdam 2step	SPHWAHDNF25YZT2D1	2863	153		
			MacAdam 3step	SPHWAHDNF25YZT3D1				
		5000	MacAdam 3step	SPHWAHDNF25YZR3J6	2756	148		
				SPHWAHDNF25YZR3D1	2894	155		
		5700	MacAdam 3step	SPHWAHDNF25YZQ3J6	2756	148		
				SPHWAHDNF25YZQ3D1	2894	155		
		6500	MacAdam 3step	SPHWAHDNF25YZP3J5	2726	146		
				SPHWAHDNF25YZP3D1	2863	153		
		90+	2700	MacAdam 2step	SPHWAHDNF27YZW2H9	2104		113
				MacAdam 3step	SPHWAHDNF27YZW3H9			
				MacAdam 2step	SPHWAHDNF27YZW2D1	2210		118
				MacAdam 3step	SPHWAHDNF27YZW3D1			
			3000	MacAdam 2step	SPHWAHDNF27YZV2J0	2207		118
				MacAdam 3step	SPHWAHDNF27YZV3J0			
MacAdam 2step	SPHWAHDNF27YZV2D1			2317	124			
MacAdam 3step	SPHWAHDNF27YZV3D1							
3500	MacAdam 2step		SPHWAHDNF27YZU2J1	2287	122			
	MacAdam 3step		SPHWAHDNF27YZU3J1					
	MacAdam 2step		SPHWAHDNF27YZU2D1	2402	129			
	MacAdam 3step		SPHWAHDNF27YZU3D1					
4000	MacAdam 2step		SPHWAHDNF27YZT2J2	2337	125			
	MacAdam 3step		SPHWAHDNF27YZT3J2					
	MacAdam 2step		SPHWAHDNF27YZT2D1	2454	131			
	MacAdam 3step		SPHWAHDNF27YZT3D1					
5000	MacAdam 3step	SPHWAHDNG27YZR3J8	2339	125				
		SPHWAHDNG27YZR3D1	2456	131				

Product	CRI	CCT (K)	Color Rank	Part Number	T _j = 85°C		I _F (mA) V _F (V)	
					Luminous Flux Typ. (lm)	Luminous Efficacy Typ. (lm/W)		
 LC026D Gen 1	80+	2700	MacAdam 2step	SPHWAHDNK25YZW2M7	3225	129	720mA 34.6V	
			MacAdam 3step	SPHWAHDNK25YZW3M7				
			MacAdam 2step	SPHWAHDNK25YZW2D1	3386	136		
			MacAdam 3step	SPHWAHDNK25YZW3D1				
		3000	MacAdam 2step	SPHWAHDNK25YZV2M9	3389	136		
			MacAdam 3step	SPHWAHDNK25YZV3M9				
			MacAdam 2step	SPHWAHDNK25YZV2D1	3558	143		
			MacAdam 3step	SPHWAHDNK25YZV3D1				
		3500	MacAdam 2step	SPHWAHDNK25YZU2N1	3488	140		
			MacAdam 3step	SPHWAHDNK25YZU3N1				
			MacAdam 2step	SPHWAHDNK25YZU2D1	3663	147		
			MacAdam 3step	SPHWAHDNK25YZU3D1				
		4000	MacAdam 2step	SPHWAHDNK25YZT2N2	3558	143		
			MacAdam 3step	SPHWAHDNK25YZT3N2				
			MacAdam 2step	SPHWAHDNK25YZT2D1	3736	150		
			MacAdam 3step	SPHWAHDNK25YZT3D1				
		5000	MacAdam 3step	SPHWAHDNK25YZR3N2	3588	144		
				SPHWAHDNK25YZR3D1	3767	151		
		5700	MacAdam 3step	SPHWAHDNK25YZQ3N3	3588	144		
				SPHWAHDNK25YZQ3D1	3767	151		
		6500	MacAdam 3step	SPHWAHDNK25YZP3N2	3558	143		
				SPHWAHDNK25YZP3D1	3736	150		
		90+	2700	MacAdam 2step	SPHWAHDNK27YZW2M0	2760		111
				MacAdam 3step	SPHWAHDNK27YZW3M0			
				MacAdam 2step	SPHWAHDNK27YZW2D1	2898		116
				MacAdam 3step	SPHWAHDNK27YZW3D1			
			3000	MacAdam 2step	SPHWAHDNK27YZV2M2	2903		117
				MacAdam 3step	SPHWAHDNK27YZV3M2			
MacAdam 2step	SPHWAHDNK27YZV2D1			3048	122			
MacAdam 3step	SPHWAHDNK27YZV3D1							
3500	MacAdam 2step		SPHWAHDNK27YZU2M4	2990	120			
	MacAdam 3step		SPHWAHDNK27YZU3M4					
	MacAdam 2step		SPHWAHDNK27YZU2D1	3139	126			
	MacAdam 3step		SPHWAHDNK27YZU3D1					
4000	MacAdam 2step		SPHWAHDNK27YZT2M5	3051	122			
	MacAdam 3step		SPHWAHDNK27YZT3M5					
	MacAdam 2step		SPHWAHDNK27YZT2D1	3204	129			
	MacAdam 3step		SPHWAHDNK27YZT3D1					
5000	MacAdam 3step	SPHWAHDNK27YZR3M5	3077	124				
		SPHWAHDNK27YZR3D1	3231	130				

D-series

Specifications

D-series

Product	CRI	CCT (K)	Color Rank	Part Number	T _j = 85°C		I _F (mA) V _F (V)
					Luminous Flux Typ. (lm)	Luminous Efficacy Typ. (lm/W)	
 LC040D Gen 1	80+	2700	MacAdam 2step	SPHWAHDNG25YZW2K0	4996	134	1080mA 34.6V
			MacAdam 3step	SPHWAHDNG25YZW3K0			
			MacAdam 2step	SPHWAHDNG25YZW2D1			
			MacAdam 3step	SPHWAHDNG25YZW3D1			
		3000	MacAdam 2step	SPHWAHDNG25YZV2K2	5257	141	
			MacAdam 3step	SPHWAHDNG25YZV3K2			
			MacAdam 2step	SPHWAHDNG25YZV2D1			
			MacAdam 3step	SPHWAHDNG25YZV3D1			
		3500	MacAdam 2step	SPHWAHDNG25YZU2K3	5418	145	
			MacAdam 3step	SPHWAHDNG25YZU3K3			
			MacAdam 2step	SPHWAHDNG25YZU2D1			
			MacAdam 3step	SPHWAHDNG25YZU3D1			
	4000	MacAdam 2step	SPHWAHDNG25YZT2K3	5535	148		
		MacAdam 3step	SPHWAHDNG25YZT3K3				
		MacAdam 2step	SPHWAHDNG25YZT2D1				
		MacAdam 3step	SPHWAHDNG25YZT3D1				
	5000	MacAdam 3step	SPHWAHDNG25YZR3K4	5561	149		
			SPHWAHDNG25YZR3D1	5839	156		
	5700	MacAdam 3step	SPHWAHDNG25YZQ3K4	5588	150		
			SPHWAHDNG25YZQ3D1	5868	157		
	6500	MacAdam 3step	SPHWAHDNG25YZP3K3	5528	148		
			SPHWAHDNG25YZP3D1	5804	155		
	90+	2700	MacAdam 2step	SPHWAHDNG27YZW2J6	4283	115	
			MacAdam 3step	SPHWAHDNG27YZW3J6			
			MacAdam 2step	SPHWAHDNG27YZW2D1			
			MacAdam 3step	SPHWAHDNG27YZW3D1			
			MacAdam 2step	SPHWAHDNG27YZV2J7			
			MacAdam 3step	SPHWAHDNG27YZV3J7			
		3000	MacAdam 2step	SPHWAHDNG27YZV2D1	4751	127	
			MacAdam 3step	SPHWAHDNG27YZV3D1			
MacAdam 2step			SPHWAHDNG27YZU2J8				
3500		MacAdam 3step	SPHWAHDNG27YZU3J8	4640	124		
		MacAdam 2step	SPHWAHDNG27YZU2D1				
		MacAdam 3step	SPHWAHDNG27YZU3D1				
4000		MacAdam 2step	SPHWAHDNG27YZT2J8	4742	127		
		MacAdam 3step	SPHWAHDNG27YZT3J8				
		MacAdam 2step	SPHWAHDNG27YZT2D1				
		MacAdam 3step	SPHWAHDNG27YZT3D1				
5000		MacAdam 3step	SPHWAHDNG27YZR3J8	4796	128		
			SPHWAHDNG27YZR3D1	5036	135		

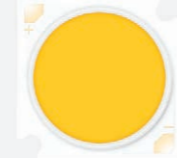
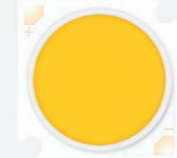
Product	CRI	CCT (K)	Color Rank	Part Number	T _j = 85°C		I _F (mA) V _F (V)
					Luminous Flux Typ. (lm)	Luminous Efficacy Typ. (lm/W)	
 LC060D Gen 1	70+	3000	MacAdam 3step	SPHWAHDNL231ZV3Q8	8284	148	1080mA 52V
		4000	MacAdam 3step	SPHWAHDNL231ZT3R1	8550	152	
		5000	MacAdam 3step	SPHWAHDNL231ZR3R2	8683	155	
	80+	2700	MacAdam 2step	SPHWAHDNL251ZW2P9	7277	130	
			MacAdam 3step	SPHWAHDNL251ZW3P9			
		3000	MacAdam 2step	SPHWAHDNL251ZV2Q3	7667	137	
			MacAdam 3step	SPHWAHDNL251ZV3Q3			
		3500	MacAdam 2step	SPHWAHDNL251ZU2Q5	7904	141	
			MacAdam 3step	SPHWAHDNL251ZU3Q5			
	4000	MacAdam 2step	SPHWAHDNL251ZT2Q6	8075	144		
		MacAdam 3step	SPHWAHDNL251ZT3Q6				
		5000	MacAdam 3step			SPHWAHDNL251ZR3Q7	
5700		MacAdam 3step	SPHWAHDNL251ZQ3Q7				
6500	MacAdam 3step	SPHWAHDNL271ZP3Q6	8066	144			
		SPHWAHDNL271ZP3Q6	8066	144			
 LC080D Gen 1	70+	3000	MacAdam 3step	SPHWAHDNM231ZV3U5	12084	143	1620mA 52V
		4000	MacAdam 3step	SPHWAHDNM231ZT3U9	12483	148	
		5000	MacAdam 3step	SPHWAHDNM231ZR3V0	12673	150	
	80+	2700	MacAdam 2step	SPHWAHDNM251ZW2T1	10612	126	
			MacAdam 3step	SPHWAHDNM251ZW3T1			
		3000	MacAdam 2step	SPHWAHDNM251ZV2T6	11201	133	
			MacAdam 3step	SPHWAHDNM251ZV3T6			
		3500	MacAdam 2step	SPHWAHDNM251ZU2T9	11533	137	
			MacAdam 3step	SPHWAHDNM251ZU3T9			
		4000	MacAdam 2step	SPHWAHDNM251ZT2U2	11780	140	
			MacAdam 3step	SPHWAHDNM251ZT3U2			
		5000	MacAdam 3step	SPHWAHDNM251ZR3U2	11847	141	
		5700	MacAdam 3step	SPHWAHDNM251ZQ3V0	11904	141	
		6500	MacAdam 3step	SPHWAHDNM251ZP3V5	11723	139	

D-series

C-Series

Make Your Business Shine

High-intensity small LES for powerfully effective retail lighting

C-series with High Intensity

Smaller LES, high intensity, higher CBCP

High lumen density COB

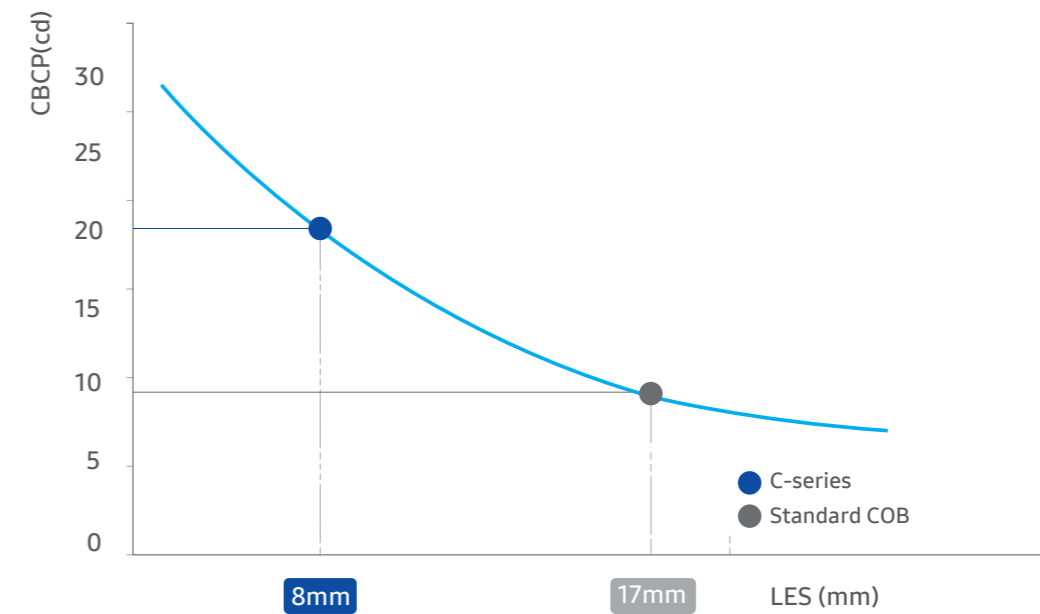

Standard COB



C-Series

C-series Gen 2 [Small LES COB]

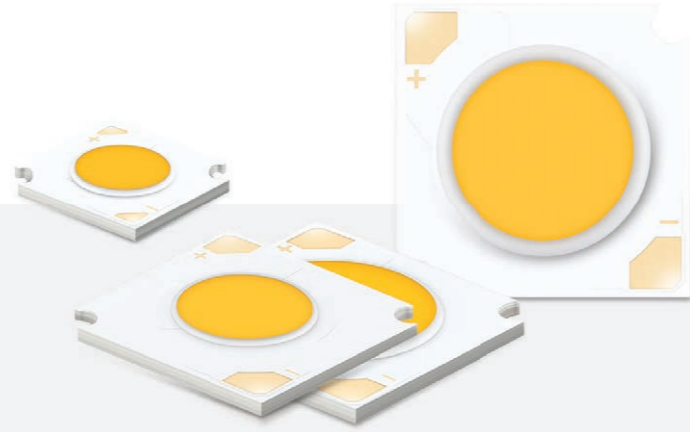

T _j =85°C	LC010C Gen 2	LC020C Gen 2	LC030C Gen 2	LC040C Gen 2
LES	6.0mm	8.5mm	11.5mm	
Typical	35.0V			
	10.5W (300mA)	21.0W (600mA)	31.5W (900mA)	36.8W (1050mA)
Max.	13.8W (380mA)	34.0W (920mA)	51.1W (1380mA)	59.5W (1610mA)
Size	13.5mm x 13.5mm	19mm x 19mm	19mm x 19mm	



Color Variation

Product	CRI90+					CRI80+				
	2700K	3000K	3500K	4000K	5000K	2700K	3000K	3500K	4000K	5000K
LC010C Gen 2	o	o	o	o	o	o	o	o	o	o
LC020C Gen 2	o	o	o	o	o	o	o	o	o	o
LC030C Gen 2	o	o	o	o	o	o	o	o	o	o
LC040C Gen 2	o	o	o	o	o	o	o	o	o	o
MacAdam 3-Step	o	o	o	o	o	o	o	o	o	o

Specifications

Product	CRI	CCT (K)	Color Rank	Part Number	T _j = 85°C		I _F (mA) V _F (V)
					Luminous Flux Typ. (lm)	Luminous Efficacy Typ. (lm/W)	
 LC010C Gen 2	80+	2700	MacAdam 3step	SPHWAHDNC25YZW3C2	1212	115	300mA 35.0V
		3000	MacAdam 3step	SPHWAHDNC25YZV3C2	1274	121	
		3500	MacAdam 3step	SPHWAHDNC25YZU3C2	1311	125	
		4000	MacAdam 3step	SPHWAHDNC25YZT3C2	1337	127	
		5000	MacAdam 3step	SPHWAHDNC25YZR3C2	1348	128	
	90+	2700	MacAdam 3step	SPHWAHDNC27YZW3C2	1037	99	
		3000	MacAdam 3step	SPHWAHDNC27YZV3C2	1091	104	
		3500	MacAdam 3step	SPHWAHDNC27YZU3C2	1123	107	
		4000	MacAdam 3step	SPHWAHDNC27YZT3C2	1147	109	
		5000	MacAdam 3step	SPHWAHDNC27YZR3C2	1156	110	

Specifications

Product	CRI	CCT (K)	Color Rank	Part Number	T _j = 85°C		I _F (mA) V _F (V)
					Luminous Flux Typ. (lm)	Luminous Efficacy Typ. (lm/W)	
 LC020C Gen 2	80+	2700	MacAdam 3step	SPHWAHDNF25YZW3C2	2485	118	600mA 35.0V
		3000	MacAdam 3step	SPHWAHDNF25YZV3C2	2625	125	
		3500	MacAdam 3step	SPHWAHDNF25YZU3C2	2688	128	
		4000	MacAdam 3step	SPHWAHDNF25YZT3C2	2742	131	
		5000	MacAdam 3step	SPHWAHDNF25YZR3C2	2765	132	
	90+	2700	MacAdam 3step	SPHWAHDNF27YZW3C2	2127	101	
		3000	MacAdam 3step	SPHWAHDNF27YZV3C2	2237	107	
		3500	MacAdam 3step	SPHWAHDNF27YZU3C2	2304	110	
		4000	MacAdam 3step	SPHWAHDNF27YZT3C2	2351	112	
		5000	MacAdam 3step	SPHWAHDNF27YZR3C2	2372	113	
 LC030C Gen 2	80+	2700	MacAdam 3step	SPHWAHDNH25YZW3C2	3765	120	900mA 35.0V
		3000	MacAdam 3step	SPHWAHDNH25YZV3C2	3956	126	
		3500	MacAdam 3step	SPHWAHDNH25YZU3C2	4072	129	
		4000	MacAdam 3step	SPHWAHDNH25YZT3C2	4154	132	
		5000	MacAdam 3step	SPHWAHDNH25YZR3C2	4188	133	
	90+	2700	MacAdam 3step	SPHWAHDNH27YZW3C2	3222	102	
		3000	MacAdam 3step	SPHWAHDNH27YZV3C2	3389	108	
		3500	MacAdam 3step	SPHWAHDNH27YZU3C2	3490	111	
		4000	MacAdam 3step	SPHWAHDNH27YZT3C2	3562	113	
		5000	MacAdam 3step	SPHWAHDNH27YZR3C2	3592	114	
 LC040C Gen 2	80+	2700	MacAdam 3step	SPHWAHDNK25YZW3C2	4305	117	1050mA 35.0V
		3000	MacAdam 3step	SPHWAHDNK25YZV3C2	4524	123	
		3500	MacAdam 3step	SPHWAHDNK25YZU3C2	4657	127	
		4000	MacAdam 3step	SPHWAHDNK25YZT3C2	4750	129	
		5000	MacAdam 3step	SPHWAHDNK25YZR3C2	4790	130	
	90+	2700	MacAdam 3step	SPHWAHDNK27YZW3C2	3684	100	
		3000	MacAdam 3step	SPHWAHDNK27YZV3C2	3875	105	
		3500	MacAdam 3step	SPHWAHDNK27YZU3C2	3991	109	
		4000	MacAdam 3step	SPHWAHDNK27YZT3C2	4073	111	
		5000	MacAdam 3step	SPHWAHDNK27YZR3C2	4108	112	

R-Series

Enriched Colors for Displaying

Vividly enhanced premium colors, contrast and exceptional white light



R-series with Specialized Spectrum

Enhanced color appearance based on color gamut and preference survey

Fashion Vivid Color



— Fashion Vivid Color LED - - - Color Standard by TM 30

Enhanced whiteness and vividness by diminishing of yellowish

Fashion Vivid White



— Fashion Vivid White LED - - - Color Standard by TM 30

Emphasizing whiteness by adjusting color point below blackbody locus

Meat



— Meat LED - - - Color Standard by TM 30

Enhanced whiteness and reddish color by using longer 650nm red phosphors

Vegetable



— Vegetable LED - - - Color Standard by TM 30

Fresh greenish color based on preference survey of 300 persons

R-series Fashion



T _j =85°C	LC013R Fashion	LC016R Fashion	LC019R Fashion	LC026R Fashion	LC033R Fashion	LC040R Fashion
LES	9.8mm		14.5mm			22mm
Typical	34.6V					
	12.5W	15.6W	18.7W	24.9W	31.1W	37.4W
	360mA	450mA	540mA	720mA	900mA	1080mA
Max.	34.5W	43.1W	51.8W	69.0W	86.2W	103.5W
	920mA	1150mA	1380mA	1840mA	2300mA	2760mA
Size	13.5mm x 13.5mm		19mm x 19mm			28mm x 28mm

Specifications

Product	CRI	CCT (K)	Color Rank	Part Number	T _j = 85°C		I _F (mA) V _F (V)
					Luminous Flux Typ. (lm)	Luminous Efficacy Typ. (lm/W)	
LC013R Fashion Vivid White	90+	3000 (Below BBL)	MacAdam 3step	SPHWAHDND2VYZVND2	1435	115	360mA 34.6V
		3500 (Below BBL)	MacAdam 3step	SPHWAHDND2VYZUND2	1494	120	
		4000 (Below BBL)	MacAdam 3step	SPHWAHDND2VYZTND2	1541	124	
LC016R Fashion Vivid White	90+	3000 (Below BBL)	MacAdam 3step	SPHWAHDNE2VYZVND2	1837	118	450mA 34.6V
		3500 (Below BBL)	MacAdam 3step	SPHWAHDNE2VYZUND2	1912	123	
		4000 (Below BBL)	MacAdam 3step	SPHWAHDNE2VYZTND2	1972	127	
LC019R Fashion Vivid White	90+	3000 (Below BBL)	MacAdam 3step	SPHWAHDNF2VYZVND2	2195	117	540mA 34.6V
		3500 (Below BBL)	MacAdam 3step	SPHWAHDNF2VYZUND2	2284	122	
		4000 (Below BBL)	MacAdam 3step	SPHWAHDNF2VYZTND2	2355	126	
LC026R Fashion Vivid White	90+	3000 (Below BBL)	MacAdam 3step	SPHWAHDNG2VYZVND2	2917	117	720mA 34.6V
		3500 (Below BBL)	MacAdam 3step	SPHWAHDNG2VYZUND2	3036	122	
		4000 (Below BBL)	MacAdam 3step	SPHWAHDNG2VYZTND2	3131	126	

Specifications

Product	CCT (K)	Color Rank	Part Number	T _j = 85°C		I _F (mA) V _F (V)
				Luminous Flux Typ. (lm)	Luminous Efficacy Typ. (lm/W)	
LC013R Fashion Vivid Color	3000 (Below BBL)	MacAdam 2step	SPHWAHDND2VYZV2D2	1334	107	360mA 34.6V
		MacAdam 3step	SPHWAHDND2VYZVVD2			
	3300 (Below BBL)	MacAdam 2step	SPHWAHDND2VYZA2D2	1394	112	
		MacAdam 3step	SPHWAHDND2VYZAVD2			
	3500 (Below BBL)	MacAdam 2step	SPHWAHDND2VYZU2D2	1433	115	
		MacAdam 3step	SPHWAHDND2VYZUVD2			
4000 (Below BBL)	MacAdam 2step	SPHWAHDND2VYZT2D2	1533	123		
	MacAdam 3step	SPHWAHDND2VYZTVD2				
LC016R Fashion Vivid Color	3000 (Below BBL)	MacAdam 2step	SPHWAHDNE2VYZV2D2	1745	112	450mA 34.6V
		MacAdam 3step	SPHWAHDNE2VYZVVD2			
	3300 (Below BBL)	MacAdam 2step	SPHWAHDNE2VYZA2D2	1823	117	
		MacAdam 3step	SPHWAHDNE2VYZAVD2			
	3500 (Below BBL)	MacAdam 2step	SPHWAHDNE2VYZU2D2	1875	120	
		MacAdam 3step	SPHWAHDNE2VYZUVD2			
4000 (Below BBL)	MacAdam 2step	SPHWAHDNE2VYZT2D2	2005	129		
	MacAdam 3step	SPHWAHDNE2VYZTVD2				
LC019R Fashion Vivid Color	3000 (Below BBL)	MacAdam 2step	SPHWAHDNF2VYZV2D2	2068	111	540mA 34.6V
		MacAdam 3step	SPHWAHDNF2VYZVVD2			
	3300 (Below BBL)	MacAdam 2step	SPHWAHDNF2VYZA2D2	2160	116	
		MacAdam 3step	SPHWAHDNF2VYZAVD2			
	3500 (Below BBL)	MacAdam 2step	SPHWAHDNF2VYZU2D2	2222	119	
		MacAdam 3step	SPHWAHDNF2VYZUVD2			
4000 (Below BBL)	MacAdam 2step	SPHWAHDNF2VYZT2D2	2376	127		
	MacAdam 3step	SPHWAHDNF2VYZTVD2				
LC026R Fashion Vivid Color	3000 (Below BBL)	MacAdam 2step	SPHWAHDNG2VYZV2D2	2706	109	720mA 34.6V
		MacAdam 3step	SPHWAHDNG2VYZVVD2			
	3300 (Below BBL)	MacAdam 2step	SPHWAHDNG2VYZA2D2	2827	113	
		MacAdam 3step	SPHWAHDNG2VYZAVD2			
	3500 (Below BBL)	MacAdam 2step	SPHWAHDNG2VYZU2D2	2907	117	
		MacAdam 3step	SPHWAHDNG2VYZUVD2			
4000 (Below BBL)	MacAdam 2step	SPHWAHDNG2VYZT2D2	3108	125		
	MacAdam 3step	SPHWAHDNG2VYZTVD2				
LC033R Fashion Vivid Color	3000 (Below BBL)	MacAdam 2step	SPHWAHDNH2VYZV2D2	3339	107	900mA 34.6V
		MacAdam 3step	SPHWAHDNH2VYZVVD2			
	3300 (Below BBL)	MacAdam 2step	SPHWAHDNH2VYZA2D2	3488	112	
		MacAdam 3step	SPHWAHDNH2VYZAVD2			
	3500 (Below BBL)	MacAdam 2step	SPHWAHDNH2VYZU2D2	3588	115	
		MacAdam 3step	SPHWAHDNH2VYZUVD2			
4000 (Below BBL)	MacAdam 2step	SPHWAHDNH2VYZT2D2	3836	123		
	MacAdam 3step	SPHWAHDNH2VYZTVD2				
LC040R Fashion Vivid Color	3000 (Below BBL)	MacAdam 2step	SPHWAHDNK2VYZV2D2	4150	111	1080mA 34.6V
		MacAdam 3step	SPHWAHDNK2VYZVVD2			
	3300 (Below BBL)	MacAdam 2step	SPHWAHDNK2VYZA2D2	4335	116	
		MacAdam 3step	SPHWAHDNK2VYZAVD2			
	3500 (Below BBL)	MacAdam 2step	SPHWAHDNK2VYZU2D2	4459	119	
		MacAdam 3step	SPHWAHDNK2VYZUVD2			
4000 (Below BBL)	MacAdam 2step	SPHWAHDNK2VYZT2D2	4768	128		
	MacAdam 3step	SPHWAHDNK2VYZTVD2				

R-series Meat



T _j =85°C	LC013R Meat	LC016R Meat	LC019R Meat	LC026R Meat	LC033R Meat
LES	9.8mm	14.5mm			
Typical	34.6V				
	12.5W	15.6W	18.7W	24.9W	31.1W
	360mA	450mA	540mA	720mA	900mA
Max.	34.5W	43.1W	51.8W	69.0W	86.2W
	920mA	1150mA	1380mA	1840mA	2300mA
Size	13.5mm x 13.5mm	19mm x 19mm			

R-series Vegetable



T _j =85°C	LC013R Vegetable	LC016R Vegetable	LC019R Vegetable	LC026R Vegetable	LC033R Vegetable
LES	9.8mm	14.5mm			
Typical	34.6V				
	12.5W	15.6W	18.7W	24.9W	31.1W
	360mA	450mA	540mA	720mA	900mA
Max.	34.5W	43.1W	51.8W	69.0W	86.2W
	920mA	1150mA	1380mA	1840mA	2300mA
Size	13.5mm x 13.5mm	19mm x 19mm			

Specifications

Product	Color Rank	Part Number	T _j = 85°C		I _f (mA) V _f (V)
			Luminous Flux Typ. (lm)	Luminous Efficacy Typ. (lm/W)	
 LC013R Meat	MacAdam 2step	SPHWHAHND2VYZTSD2	914	73	360mA 34.6V
 LC016R Meat	MacAdam 2step	SPHWHAHNE2VYZTSD2	1188	76	450mA 34.6V
 LC019R Meat	MacAdam 2step	SPHWHAHNF2VYZTSD2	1412	76	540mA 34.6V
 LC026R Meat	MacAdam 2step	SPHWHAHNG2VYZTSD2	1845	74	720mA 34.6V
 LC033R Meat	MacAdam 2step	SPHWHAHNH2VYZTSD2	2284	73	900mA 34.6V

Specifications

Product	Color Rank	Part Number	T _j = 85°C		I _f (mA) V _f (V)
			Luminous Flux Typ. (lm)	Luminous Efficacy Typ. (lm/W)	
 LC013R Vegetable	MacAdam 2step	SPHWHAHND2VYZRSD2	1188	95	360mA 34.6V
 LC016R Vegetable	MacAdam 2step	SPHWHAHNE2VYZRSD2	1544	99	450mA 34.6V
 LC019R Vegetable	MacAdam 2step	SPHWHAHNF2VYZRSD2	1835	98	540mA 34.6V
 LC026R Vegetable	MacAdam 2step	SPHWHAHNG2VYZRSD2	2399	96	720mA 34.6V
 LC033R Vegetable	MacAdam 2step	SPHWHAHNH2VYZRSD2	2969	95	900mA 34.6V



T-Series

Perfect Ambience Created by Light

Tunable lighting enriches your life more than ever through superb optimizations

T-series with White Color Tunability

Provides a wide CCT tunable range

High Color Quality

Excellent color mixing with optimized chip arrangements

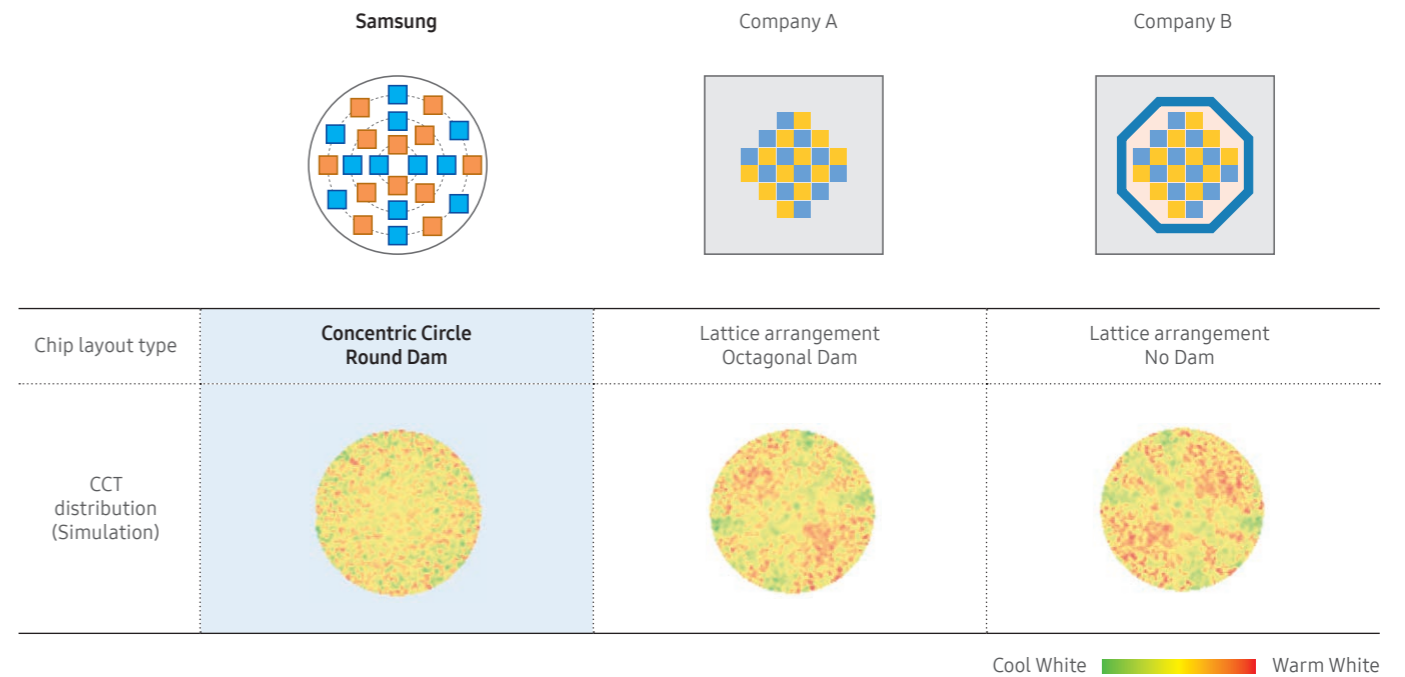

Wide Range of Color Temperature

From 2700K thru 6500K white color tunable

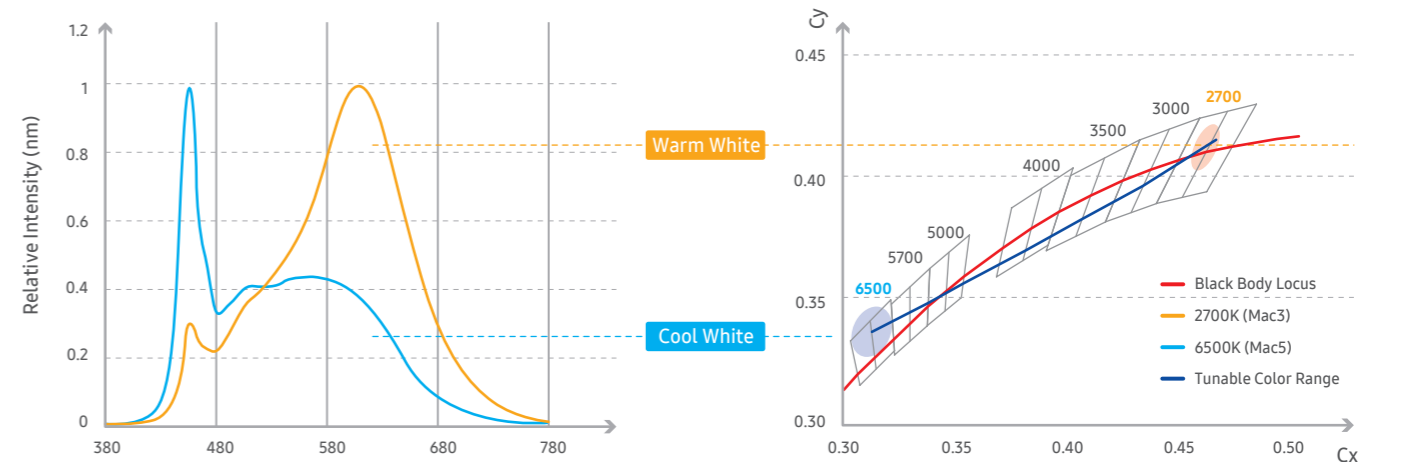

T-series



T _j =85°C	LC010T	LC020T	LC035T
LES	9.8mm	13mm	22mm
Typical	9.8W	19.6W	34.3W
	280mA	560mA	980mA
Max.	15W	30W	45W
	400mA	800mA	1250mA
Size	19mm x 19mm		28mm x 28mm

Product Details

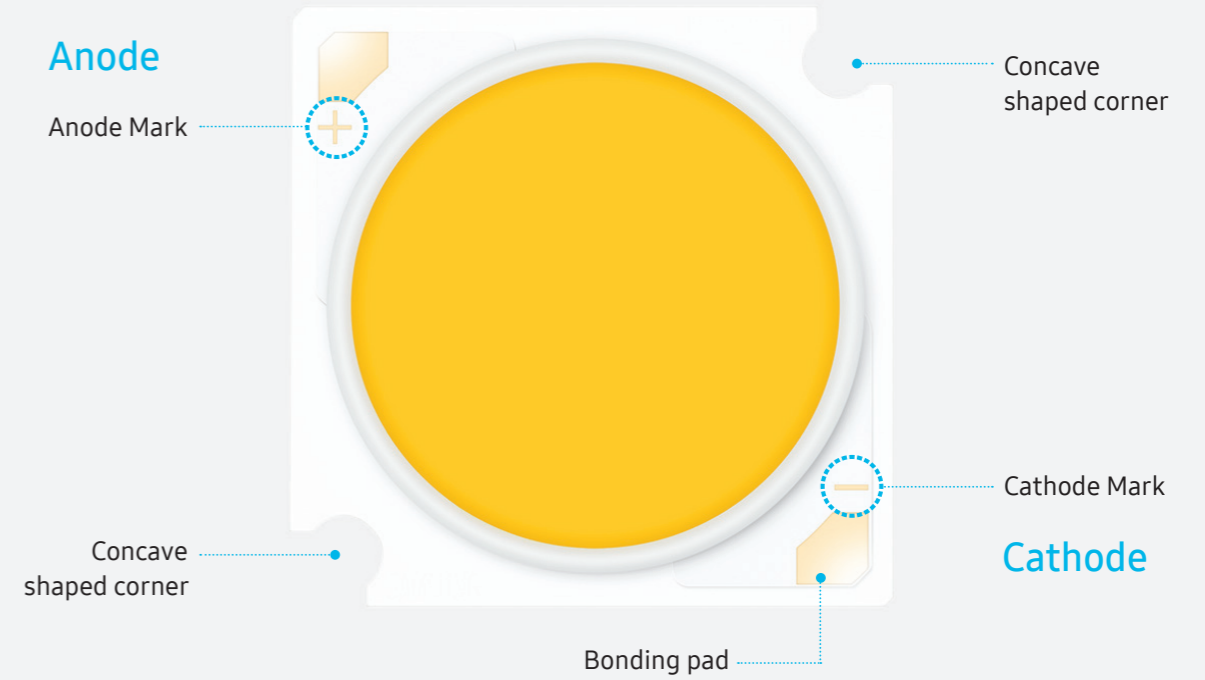

Specifications

Product	CRI	CCT (K)	Color Rank	Part Number	T _j = 85°C		I _F (mA) V _F (V)
					Luminous Flux Typ. (lm)	Luminous Efficacy Typ. (lm/W)	
 LC010T	80+	2700	MacAdam 3step	SPHWAHDNC25YZWPT1	1011	103	280mA 35V
		6500	MacAdam 5step		1313	134	
 LC020T	80+	2700	MacAdam 3step	SPHWAHDNF25YZWPT1	2022	103	560mA 35V
		6500	MacAdam 5step		2626	134	
 LC035T	80+	2700	MacAdam 3step	SPHWAHDNH25YZWPT1	3698	108	980mA 35V
		6500	MacAdam 5step		4802	140	

Product Dimensions

D-series

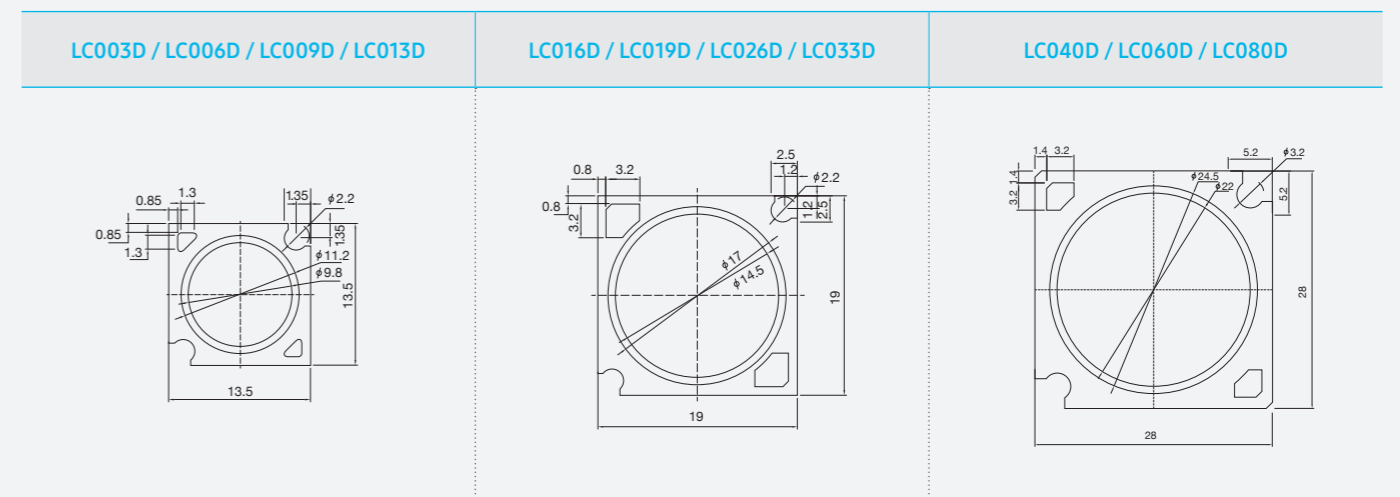

Product Dimensions

C-series

LC010C Gen 2	LC020C Gen 2	LC030C Gen 2 / LC040C Gen 2

R-series

LC003R / LC006R / LC009R / LC013R	LC016R / LC019R / LC026R / LC033R	LC040R / LC060R / LC080R

T-series

LC010T	LC020T	LC035T

One Stop Solution

Samsung maintains a close partnership with major component makers across the industry with expertise in power, optic, holder and thermal management technology. This wide network enables the “One Stop Solution” for our customers, realizing superior compatibility and convenient set-ups.



Looking for pricing, stock, or lifecycle information?

Click below to explore more details on WIN SOURCE:

 [View SPHWHAMDND27YZU3D1 on WIN SOURCE](#)

 [Samsung Information](#)

Optimize Your Supply Chain with WIN SOURCE Solutions

-  Global Sourcing Solution
-  Obsolete Management
-  Cost Control Management
-  Shortage Management
-  Alternative Solution
-  Excess Inventory Management