



**THE DATASHEET OF  
SPHWW1HDNB25YHU3B3**



## High Power LED Series Chip on Board

# LC019B - Gen3

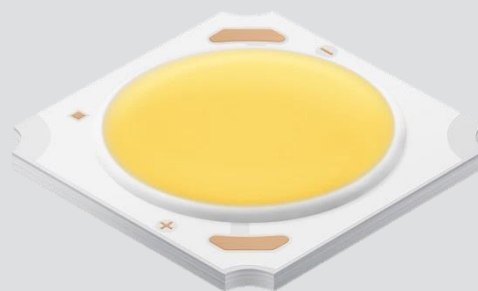

High efficacy COB LED package,  
well-suited for use in spotlight applications

### Features & Benefits

- Chip on Board (COB) solution makes it easy to design in
- Simple assembly reduces manufacturing cost
- Low thermal resistance
- InGaN/GaN MQW LED with long time reliability
- Completed 6,000 hours of LM-80 Testing

### Applications

- Spotlight / Downlight
- LED Retrofit Bulbs
- Outdoor Illumination



## Table of Contents

|    |                                     |       |    |
|----|-------------------------------------|-------|----|
| 1. | Characteristics                     | ----- | 3  |
| 2. | Product Code Information            | ----- | 5  |
| 3. | Typical Characteristics Graphs      | ----- | 10 |
| 4. | Outline Drawing & Dimension         | ----- | 14 |
| 5. | Reliability Test Items & Conditions | ----- | 15 |
| 6. | Label Structure                     | ----- | 16 |
| 7. | Packing Structure                   | ----- | 17 |
| 8. | Precautions in Handling & Use       | ----- | 19 |

## 1. Characteristics

### a) Absolute Maximum Rating

| Item                            | Symbol    | Rating     | Unit | Condition |
|---------------------------------|-----------|------------|------|-----------|
| Ambient / Operating Temperature | $T_a$     | -40 ~ +105 | °C   | -         |
| Storage Temperature             | $T_{stg}$ | -40 ~ +120 | °C   | -         |
| LED Junction Temperature        | $T_j$     | 150        | °C   | -         |
| Case Temperature                | $T_c$     | 105        | °C   | *Note     |
| Forward Current                 | $I_F$     | 980        | mA   | -         |
| Power Dissipation               | $P_D$     | 36.3       | W    | -         |
| ESD (HBM)                       | -         | ±2         | kV   | -         |
| ESD (MM)                        | -         | ±0.5       | kV   | -         |

### b) Electro-optical Characteristics ( $I_F = 540 \text{ mA}$ , $T_c = 25 \text{ °C}$ )

| Item  | Unit | Rank   | Min. | Typ. | Max. |
|---|------|--------|------|------|------|
| Forward Voltage ( $V_F$ )                   | V    | YH     | 32.5 | 35.5 | 38.5 |
| Color Rendering Index ( $R_a$ )             | -    | 5      | 80   | -    | -    |
|   |      | 7      | 90   | -    | -    |
| Thermal Resistance (junction to chip point) | °C/W |        | -    | 1.5  | -    |
| Beam Angle                                  | °    |        | -    | 115  | -    |
| Nominal Power                               | W    |        |      | 19.2 |      |
| Eye Protection                              |      | Risk 1 | -    |      | -    |

#### Notes:

- 1) The COB is tested in pulsed condition at rated test current (10 ms pulse width) and rated temperature ( $T_j = T_c = T_a = 25 \text{ °C}$ )
- 2) Samsung maintains measurement tolerance of: forward voltage =  $\pm 5 \%$ , CRI =  $\pm 1$
- 3) Refer to the derating curve, '3. Typical Characteristics Graph' designed within the range

### c) Luminous Flux Characteristics ( $I_F = 540 \text{ mA}$ )

| CRI ( $R_a$ ) | Nominal<br>CCT (K) | Flux<br>Rank | Flux<br>Bin | Sorting <sup>1)</sup> @ $T_c = 25 \text{ }^\circ\text{C}$ (lm) |      | Calculated Flux <sup>2)</sup> @ $T_c = 85 \text{ }^\circ\text{C}$ (lm) |      |      |
|---------------|--------------------|--------------|-------------|--|------|--|------|------|
|               |                    |              |             | Min.   | Max. | Min.   | Max. |      |
| 80            | 2700               | B3           | 25          | 2650   | 2813 | 2412   | 2560 |      |
|               |                    |              | 26          | 2813   | 3034 | 2560   | 2761 |      |
|               | 3000               | B3           | 25          | 2819   | 2992 | 2565   | 2723 |      |
|               |                    |              | 26          | 2992   | 3227 | 2723   | 2937 |      |
|               | 3500               | B3           | 24          | 2725   | 2904 | 2480   | 2643 |      |
|               |                    |              | 25          | 2904   | 3082 | 2643   | 2805 |      |
|               |                    |              | 26          | 3082   | 3319 | 2805   | 3020 |      |
|               | 4000               | B3           | 24          | 2805   | 2988 | 2553   | 2719 |      |
|               |                    |              | 25          | 2988   | 3172 | 2719   | 2887 |      |
|               |                    |              | 26          | 3172   | 3420 | 2887   | 3112 |      |
|               | 5000               | B3           | 24          | 2831   | 3016 | 2576   | 2745 |      |
|               |                    |              | 25          | 3016   | 3202 | 2745   | 2914 |      |
|               |                    |              | 26          | 3202   | 3451 | 2914   | 3140 |      |
|               | 5700               | B3           | 24          | 2831   | 3016 | 2576   | 2745 |      |
|               |                    |              | 25          | 3016   | 3202 | 2745   | 2914 |      |
|               |                    |              | 26          | 3202   | 3451 | 2914   | 3140 |      |
|               | 90                 | 2700         | B3          | 23   | 2084 | 2251   | 1896 | 2048 |
|               |                    |              |             | 24   | 2251 | 2481   | 2048 | 2258 |
| 25            |                    |              |             | 2481   | 2698 | 2258   | 2455 |      |
| 3000          |                    | B3           | 23          | 2127   | 2297 | 1936   | 2090 |      |
|               |                    |              | 24          | 2297   | 2527 | 2090   | 2300 |      |
|               |                    |              | 25          | 2527   | 2759 | 2300   | 2511 |      |
| 3500          |                    | B3           | 23          | 2191   | 2366 | 1994   | 2153 |      |
|               |                    |              | 24          | 2366   | 2596 | 2153   | 2362 |      |
|               |                    |              | 25          | 2596   | 2830 | 2362   | 2575 |      |
| 4000          |                    | B3           | 23          | 2254   | 2435 | 2051   | 2216 |      |
|               |                    |              | 24          | 2435   | 2665 | 2216   | 2425 |      |
|               |                    |              | 25          | 2665   | 2901 | 2425   | 2640 |      |

#### Notes:

- 1) The COB is tested in pulsed condition at rated test current (10 ms pulse width) and rated temperature ( $T_j = T_c = T_a = 25 \text{ }^\circ\text{C}$ )
- 2) Calculated flux values are for reference only
- 3) Samsung maintains measurement tolerance of: luminous flux =  $\pm 7 \%$ , CRI =  $\pm 1$

## 2. Product Code Information

|   |   |   |   |   |   |   |   |   |    |    |    |    |    |    |    |    |    |
|---|---|---|---|---|---|---|---|---|----|----|----|----|----|----|----|----|----|
| 1 | 2 | 3 | 4 | 5 | 6 | 7 | 8 | 9 | 10 | 11 | 12 | 13 | 14 | 15 | 16 | 17 | 18 |
| S | P | H | C | W | 1 | H | D | N | B  | 2  | 5  | Y  | H  | R  | T  | B  | 3  |

| Digit | PKG Information            | Code   | Specification   |
|-------|----------------------------|--|---|
| 1 2 3 | Samsung Package High Power | <b>SPH</b>   |   |
| 4 5   | Color                      | <b>WW</b><br><b>CW</b>   | Warm White (T/U/V/W Ranks)<br>Cool White (Q/R Ranks)  |
| 6     | Product Version            | <b>1</b>   |   |
| 7 8   | Form Factor                | <b>HD</b>  | COB   |
| 9     | Lens Type                  | <b>N</b>   | No lens   |
| 10    | Internal Code              | <b>B</b>   | LC019   |
| 11    | Chip Type                  | <b>2</b>   |   |
| 12    | CRI & Sorting Temperature  | <b>5</b><br><b>7</b>   | Min. 80<br>25 °C<br>Min. 90   |
| 13 14 | Forward Voltage (V)        | <b>YH</b>  | 32.5~38.5   |
| 15    | CCT (K)                    | <b>W</b><br><b>V</b><br><b>U</b><br><b>T</b><br><b>R</b><br><b>Q</b> | 2700 K WA, WB (MacAdam Ellipse)<br>3000 K VA, VB (MacAdam Ellipse) VW, VX, VY, VZ (ANSI bin)<br>3500 K UA, UB (MacAdam Ellipse)<br>4000 K TA, TB (MacAdam Ellipse) TW, TX, TY, TZ (ANSI bin)<br>5000 K RA (MacAdam Ellipse) RW, RX, RY, RZ (ANSI bin)<br>5700 K QW, QX, QY, QZ (ANSI bin) |
| 16    | MacAdam / ANSI             | <b>2</b><br><b>3</b><br><b>T</b>                                     | MacAdam 2-step<br>MacAdam 3-step<br>ANSI bin  |
| 17 18 | Luminous Flux              | <b>B3</b>  | Bin Code: 24, 25, 26 (80 CRI)<br>23, 24, 25 (90 CRI);   |

a) Binning Structure ( $I_F = 540 \text{ mA}$ ,  $T_c = 25 \text{ }^\circ\text{C}$ )

| CRI (R <sub>a</sub> ) | Nominal | Product Code        | V <sub>F</sub> | Color | Chrom.            | Flux | Flux | Flux Range            |             |
|-----------------------|---------|---------------------|----------------|-------|-------------------|------|------|-----------------------|-------------|
| Min.                  | CCT (K) |                     | Rank           | Rank  | Bin               | Rank | Bin  | (Φ <sub>v</sub> , lm) |             |
| 80                    | 2700    | SPHWW1HDNB25YHW2B3  | YH             | W2    | WB                | B3   | 25   | 2650 ~ 2813           |             |
|                       |         |                     |                |       |                   |      | 26   | 2813 ~ 3034           |             |
|                       |         | SPHWW1HDNB25YHW3B3  | YH             | W3    | WA, WB            | B3   | 25   | 2650 ~ 2813           |             |
|                       |         |                     |                |       |                   |      | 26   | 2813 ~ 3034           |             |
|                       | 3000    | SPHWW1HDNB25YHV2B3  | YH             | V2    | VB                | B3   | 25   | 2819 ~ 2992           |             |
|                       |         |                     |                |       |                   |      | 26   | 2992 ~ 3227           |             |
|                       |         | SPHWW1HDNB25YHV3B3  | YH             | V3    | VA, VB            | B3   | 25   | 2819 ~ 2992           |             |
|                       |         |                     |                |       |                   |      | 26   | 2992 ~ 3227           |             |
|                       | 3500    | SPHWW1HDNB25YHU2B3  | YH             | U2    | UB                | B3   | 24   | 2725 ~ 2904           |             |
|                       |         |                     |                |       |                   |      | 25   | 2904 ~ 3082           |             |
|                       |         | SPHWW1HDNB25YHU3B3  | YH             | U3    | UA, UB            | B3   | 26   | 3082 ~ 3319           |             |
|                       |         |                     |                |       |                   |      | 24   | 2725 ~ 2904           |             |
|                       | 4000    | SPHWW1HDNB25YHT2B3  | YH             | T2    | TB                | B3   | 25   | 2988 ~ 3172           |             |
|                       |         |                     |                |       |                   |      | 26   | 3172 ~ 3420           |             |
|                       |         | SPHWW1HDNB25YHT3B3  | YH             | T3    | TA, TB            | B3   | 24   | 2805 ~ 2988           |             |
|                       |         |                     |                |       |                   |      | 25   | 2988 ~ 3172           |             |
|                       | 5000    | SPHCW1HDNB25YHR3B3  | YH             | R3    | RA                | B3   | 26   | 3172 ~ 3420           |             |
|                       |         |                     |                |       |                   |      | 24   | 2831 ~ 3016           |             |
|                       |         | SPHCW1HDNB25YHRTB3  | YH             | RT    | RW, RX,<br>RY, RZ | B3   | 25   | 3016 ~ 3202           |             |
|                       |         |                     |                |       |                   |      | 26   | 3202 ~ 3451           |             |
|                       | 5700    | SPHCW1HDNB25YHQT B3 | YH             | QT    | QW, QX,<br>QY, QZ | B3   | 24   | 2831 ~ 3016           |             |
|                       |         |                     |                |       |                   |      | 25   | 3016 ~ 3202           |             |
|                       |         |                     |                |       |                   |      |      | 26                    | 3202 ~ 3451 |
|                       |         |                     |                |       |                   |      |      |                       |             |

a) Binning Structure ( $I_F = 540 \text{ mA}$ ,  $T_c = 25 \text{ }^\circ\text{C}$ )

| CRI ( $R_a$ )<br>Min. | Nominal<br>CCT (K) | Product Code       | $V_F$<br>Rank | Color<br>Rank | Chrom.<br>Bin | Flux<br>Rank | Flux<br>Bin | Flux Range<br>( $\Phi_v$ , lm) |
|-----------------------|--------------------|--------------------|---------------|---------------|---------------|--------------|-------------|--------------------------------|
| 90                    | 2700               | SPHWW1HDNB27YHW2B3 | YH            | W2            | WB            | B3           | 23          | 2084 ~ 2251                    |
|                       |                    |                    |               |               |               |              | 24          | 2251 ~ 2481                    |
|                       |                    |                    |               |               |               |              | 25          | 2481 ~ 2698                    |
|                       |                    | SPHWW1HDNB27YHW3B3 | YH            | W3            | WA, WB        | B3           | 23          | 2084 ~ 2251                    |
|                       |                    |                    |               |               |               |              | 24          | 2251 ~ 2481                    |
|                       |                    |                    |               |               |               |              | 25          | 2481 ~ 2698                    |
|                       | 3000               | SPHWW1HDNB27YHV2B3 | YH            | V2            | VB            | B3           | 23          | 2127 ~ 2297                    |
|                       |                    |                    |               |               |               |              | 24          | 2297 ~ 2527                    |
|                       |                    |                    |               |               |               |              | 25          | 2527 ~ 2759                    |
|                       |                    | SPHWW1HDNB27YHV3B3 | YH            | V3            | VA, VB        | B3           | 23          | 2127 ~ 2297                    |
|                       |                    |                    |               |               |               |              | 24          | 2297 ~ 2527                    |
|                       |                    |                    |               |               |               |              | 25          | 2527 ~ 2759                    |
|                       | 3500               | SPHWW1HDNB27YHU2B3 | YH            | U2            | UB            | B3           | 23          | 2191 ~ 2366                    |
|                       |                    |                    |               |               |               |              | 24          | 2366 ~ 2596                    |
|                       |                    |                    |               |               |               |              | 25          | 2596 ~ 2830                    |
|                       |                    | SPHWW1HDNB27YHU3B3 | YH            | U3            | UA, UB        | B3           | 23          | 2191 ~ 2366                    |
|                       |                    |                    |               |               |               |              | 24          | 2366 ~ 2596                    |
|                       |                    |                    |               |               |               |              | 25          | 2596 ~ 2830                    |
|                       | 4000               | SPHWW1HDNB27YHT2B3 | YH            | T2            | TB            | B3           | 23          | 2254 ~ 2435                    |
|                       |                    |                    |               |               |               |              | 24          | 2435 ~ 2665                    |
|                       |                    |                    |               |               |               |              | 25          | 2665 ~ 2901                    |
|                       |                    | SPHWW1HDNB27YHT3B3 | YH            | T3            | TA, TB        | B3           | 23          | 2254 ~ 2435                    |
|                       |                    |                    |               |               |               |              | 24          | 2435 ~ 2665                    |
|                       |                    |                    |               |               |               |              | 25          | 2665 ~ 2901                    |

b) Chromaticity Region & Coordinates ( $I_F = 540 \text{ mA}$ ,  $T_c = 25 \text{ }^\circ\text{C}$ )

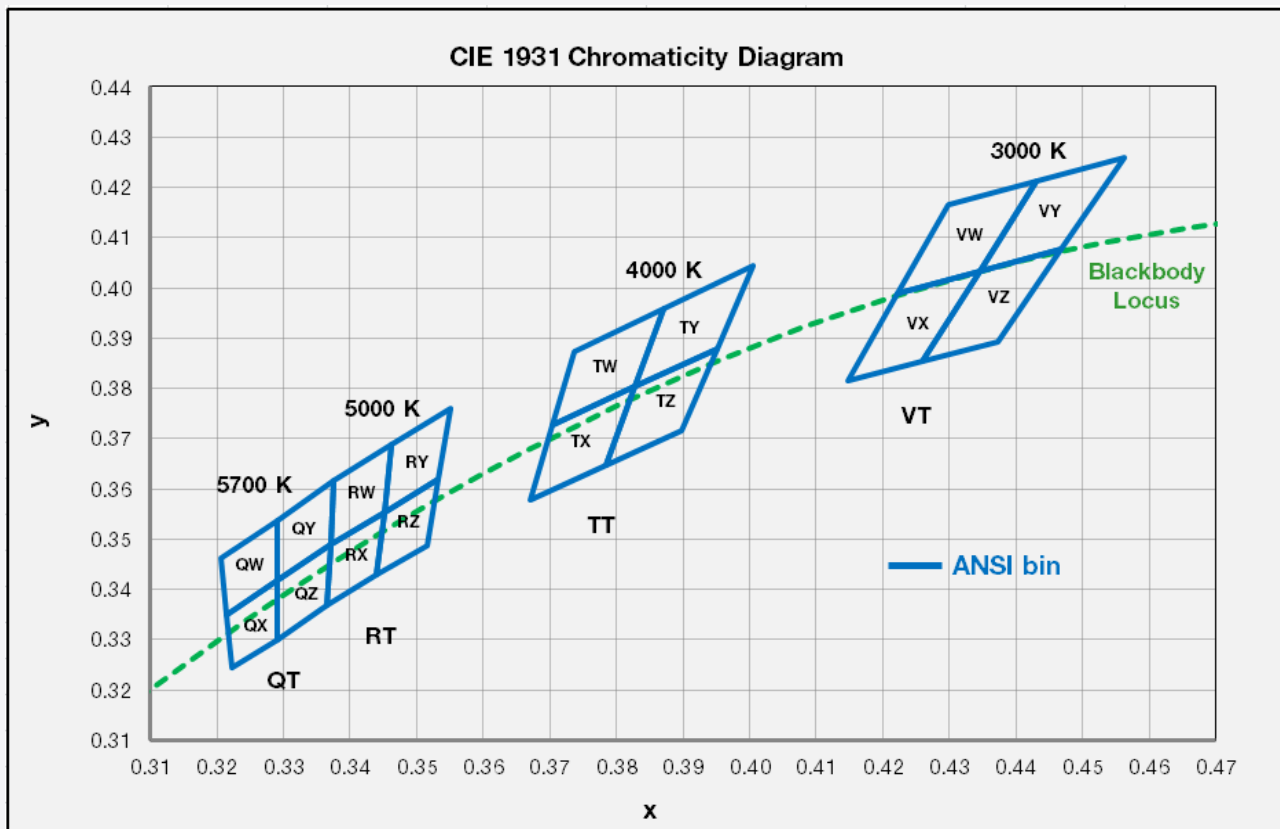

| Region                 | CIE x  | CIE y  | Region | CIE x  | CIE y  |
|------------------------|--------|--------|--------|--------|--------|
| <b>V rank (3000 K)</b> |        |        |        |        |        |
| VW                     | 0.4223 | 0.399  | VY     | 0.4345 | 0.4033 |
|                        | 0.4345 | 0.4033 |        | 0.4468 | 0.4077 |
|                        | 0.4431 | 0.4213 |        | 0.4562 | 0.4260 |
|                        | 0.4299 | 0.4165 |        | 0.4431 | 0.4213 |
| VX                     | 0.4223 | 0.399  | VZ     | 0.4260 | 0.3854 |
|                        | 0.4147 | 0.3814 |        | 0.4373 | 0.3893 |
|                        | 0.4260 | 0.3854 |        | 0.4468 | 0.4077 |
|                        | 0.4345 | 0.4033 |        | 0.4345 | 0.4033 |
| <b>R rank (5000 K)</b> |        |        |        |        |        |
| RW                     | 0.3376 | 0.3616 | RY     | 0.3463 | 0.3687 |
|                        | 0.3463 | 0.3687 |        | 0.3551 | 0.3760 |
|                        | 0.3451 | 0.3554 |        | 0.3533 | 0.3620 |
|                        | 0.3371 | 0.3490 |        | 0.3451 | 0.3554 |
| RX                     | 0.3371 | 0.3490 | RZ     | 0.3451 | 0.3554 |
|                        | 0.3451 | 0.3554 |        | 0.3533 | 0.3620 |
|                        | 0.3440 | 0.3428 |        | 0.3515 | 0.3487 |
|                        | 0.3366 | 0.3369 |        | 0.3440 | 0.3428 |

| Region                 | CIE x  | CIE y  | Region | CIE x  | CIE y  |
|------------------------|--------|--------|--------|--------|--------|
| <b>T rank (4000 K)</b> |        |        |        |        |        |
| TW                     | 0.3736 | 0.3874 | TY     | 0.3871 | 0.3959 |
|                        | 0.3871 | 0.3959 |        | 0.4006 | 0.4044 |
|                        | 0.3828 | 0.3803 |        | 0.3952 | 0.388  |
|                        | 0.3703 | 0.3726 |        | 0.3828 | 0.3803 |
| TX                     | 0.3703 | 0.3726 | TZ     | 0.3828 | 0.3803 |
|                        | 0.3828 | 0.3803 |        | 0.3952 | 0.388  |
|                        | 0.3784 | 0.3647 |        | 0.3898 | 0.3716 |
|                        | 0.367  | 0.3578 |        | 0.3784 | 0.3647 |
| <b>Q rank (5700 K)</b> |        |        |        |        |        |
| QW                     | 0.3207 | 0.3462 | QY     | 0.3290 | 0.3538 |
|                        | 0.3290 | 0.3538 |        | 0.3376 | 0.3616 |
|                        | 0.3290 | 0.3417 |        | 0.3371 | 0.3490 |
|                        | 0.3215 | 0.3350 |        | 0.3290 | 0.3417 |
| QX                     | 0.3215 | 0.3350 | QZ     | 0.3290 | 0.3417 |
|                        | 0.3290 | 0.3417 |        | 0.3371 | 0.3490 |
|                        | 0.3290 | 0.3300 |        | 0.3366 | 0.3369 |
|                        | 0.3222 | 0.3243 |        | 0.3290 | 0.3300 |

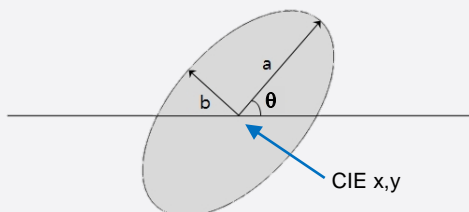
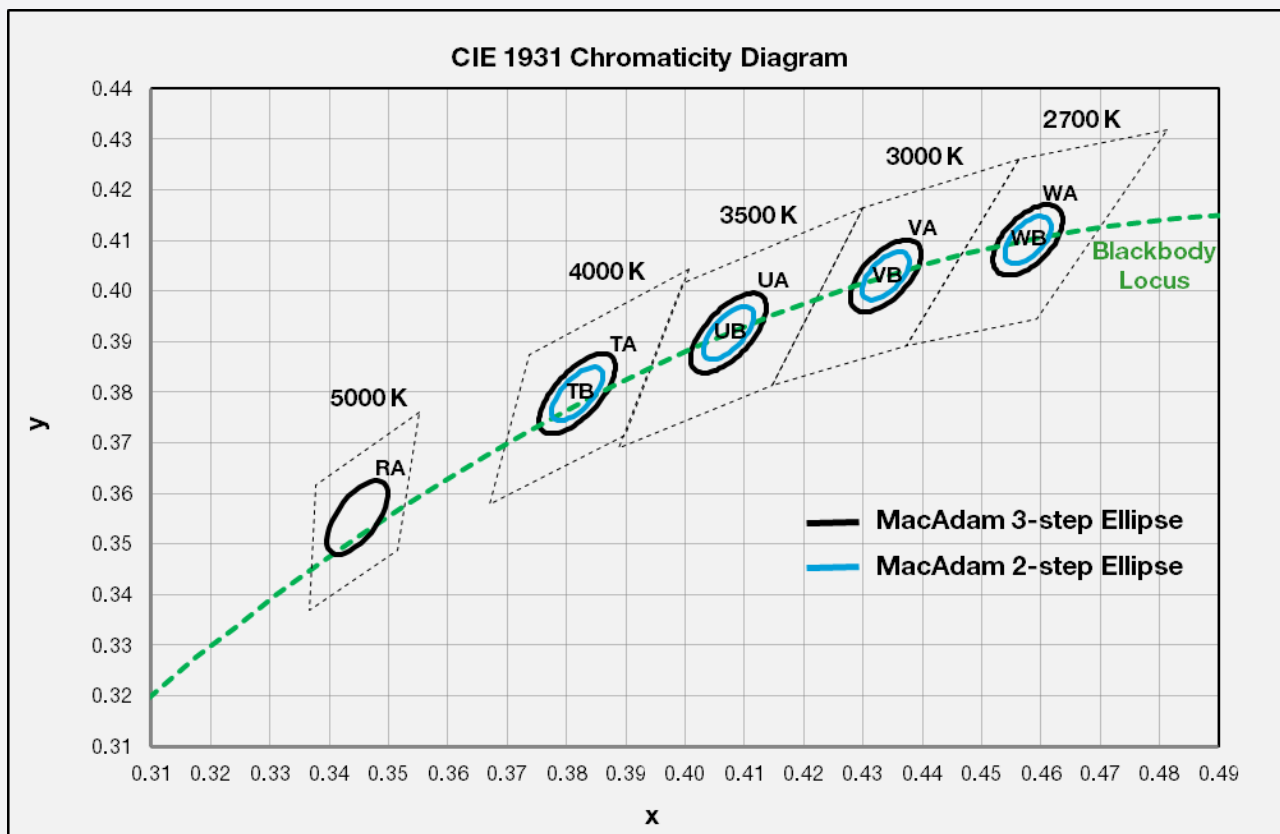
**b) Chromaticity Region & Coordinates ( $I_F = 540 \text{ mA}$ ,  $T_c = 25 \text{ }^\circ\text{C}$ )**

| MacAdam Ellipse (WA, WB) |        |        |          |        |        |
|--------------------------|--------|--------|----------|--------|--------|
| Step                     | CIE x  | CIE y  | $\theta$ | a      | b      |
| 2-step                   | 0.4578 | 0.4101 | 53.70    | 0.0054 | 0.0028 |
| 3-step                   | 0.4578 | 0.4101 | 53.70    | 0.0081 | 0.0042 |

| MacAdam Ellipse (VA, VB) |        |        |          |        |        |
|--------------------------|--------|--------|----------|--------|--------|
| Step                     | CIE x  | CIE y  | $\theta$ | a      | b      |
| 2-step                   | 0.4338 | 0.403  | 53.22    | 0.0056 | 0.0027 |
| 3-step                   | 0.4338 | 0.4030 | 53.22    | 0.0083 | 0.0041 |

| MacAdam Ellipse (UA, UB) |        |        |          |        |        |
|--------------------------|--------|--------|----------|--------|--------|
| Step                     | CIE x  | CIE y  | $\theta$ | a      | b      |
| 2-step                   | 0.4073 | 0.3917 | 54.00    | 0.0062 | 0.0028 |
| 3-step                   | 0.4073 | 0.3917 | 54.00    | 0.0093 | 0.0041 |

| MacAdam Ellipse (TA, TB) |        |        |          |        |        |
|--------------------------|--------|--------|----------|--------|--------|
| Step                     | CIE x  | CIE y  | $\theta$ | a      | b      |
| 2-step                   | 0.3818 | 0.3797 | 53.72    | 0.0063 | 0.0027 |
| 3-step                   | 0.3818 | 0.3797 | 53.72    | 0.0094 | 0.0040 |

| MacAdam Ellipse (RA) |        |        |          |        |        |
|----------------------|--------|--------|----------|--------|--------|
| Step                 | CIE x  | CIE y  | $\theta$ | a      | b      |
| 3-step               | 0.3447 | 0.3553 | 59.62    | 0.0082 | 0.0035 |

**Note:**

Samsung maintains measurement tolerance of:  $C_x, C_y = \pm 0.005$

### 3. Typical Characteristics Graphs

#### a) Spectrum Distribution ( $I_f = 540 \text{ mA}$ , $T_c = 25 \text{ }^\circ\text{C}$ )

CCT: 2700 K (80 CRI)

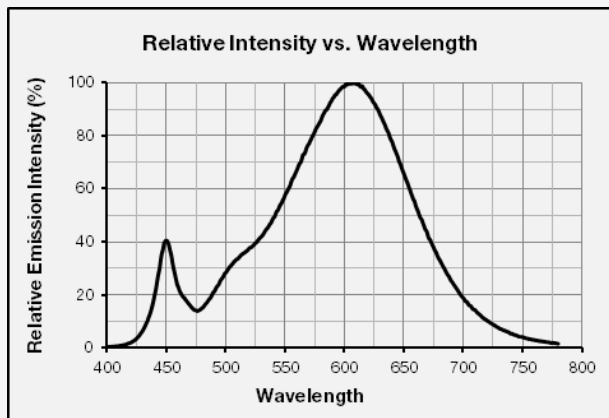

CCT: 3000 K (80 CRI)

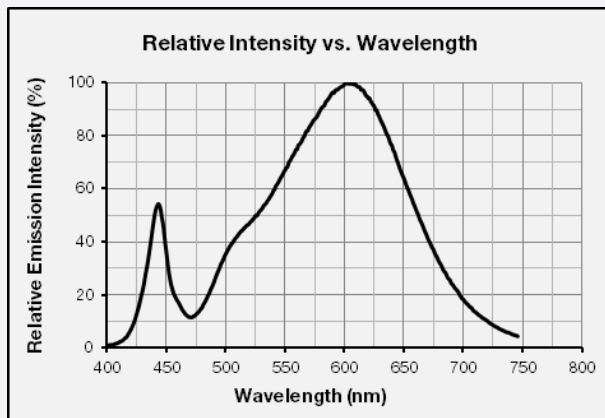

CCT: 3500 K (80 CRI)

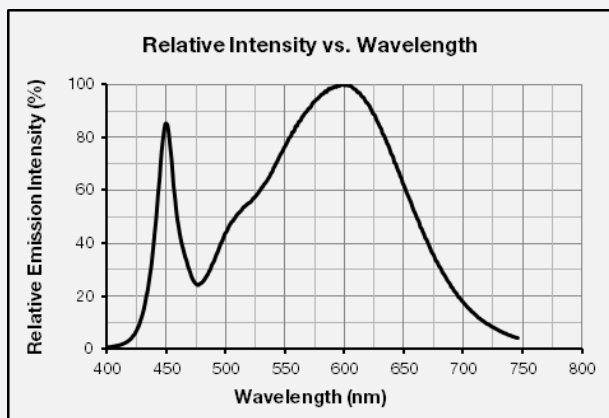

CCT: 4000 K (80 CRI)

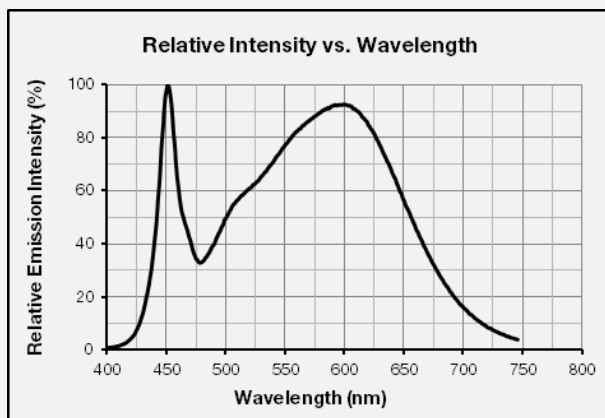

CCT: 5000 K (80 CRI)

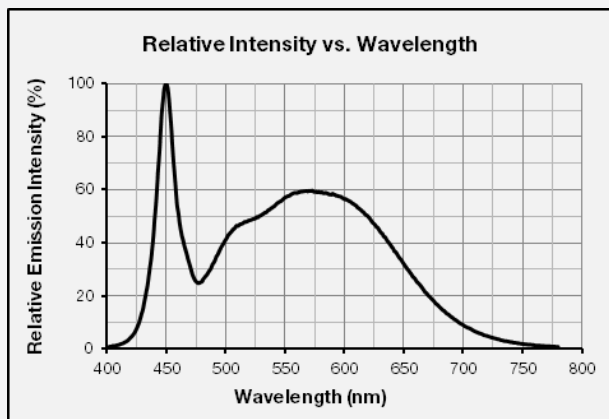

CCT: 5700 K (80 CRI)

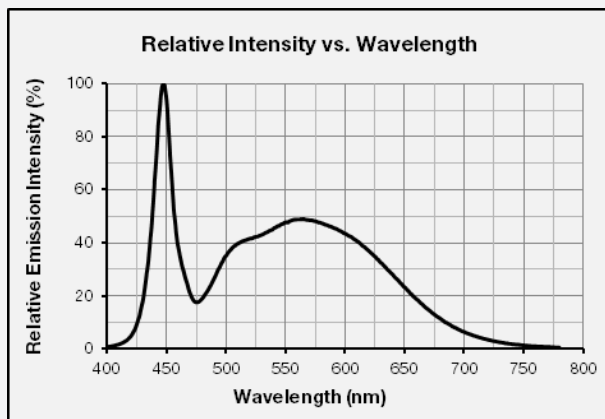

CCT: 2700 K (90 CRI)

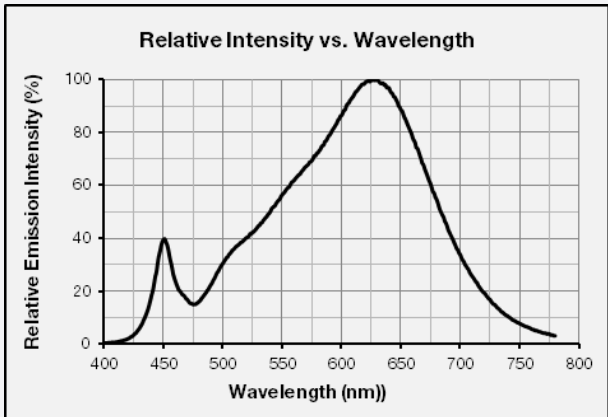

CCT: 3000 K (90 CRI)

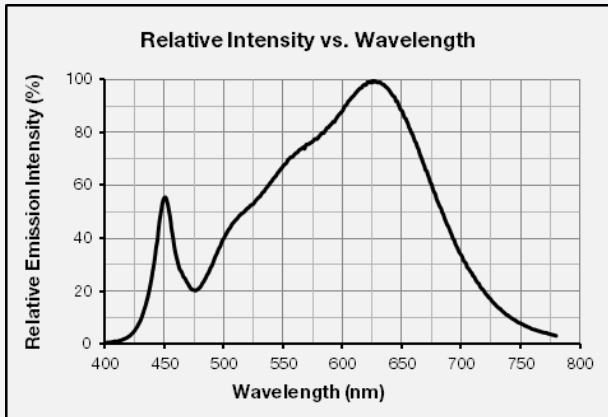

CCT: 3500 K (90 CRI)

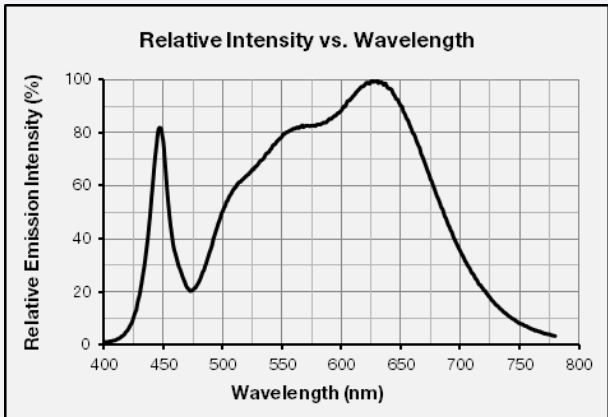

CCT: 4000 K (90 CRI)

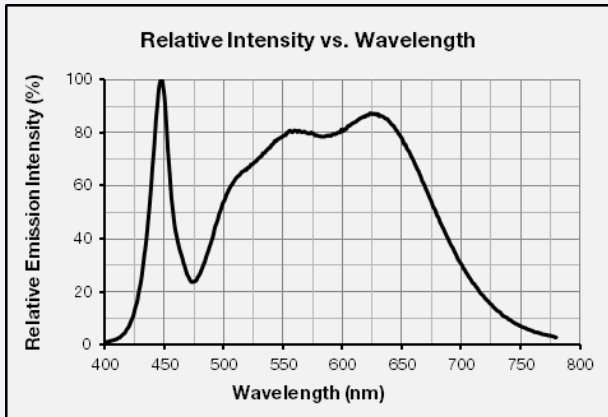

**b) Forward Current Characteristics (T<sub>c</sub> = 25 °C)**

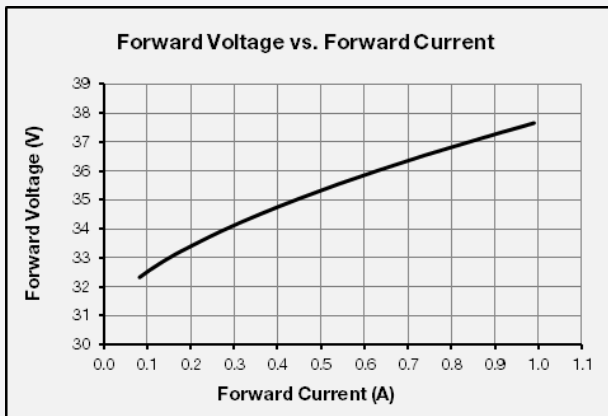
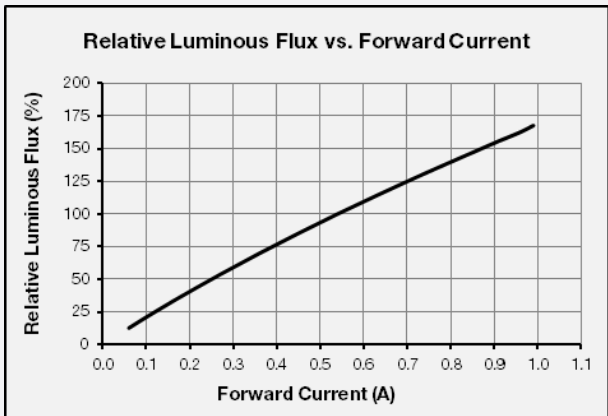

c) Temperature Characteristics ( $I_F = 540 \text{ mA}$ )

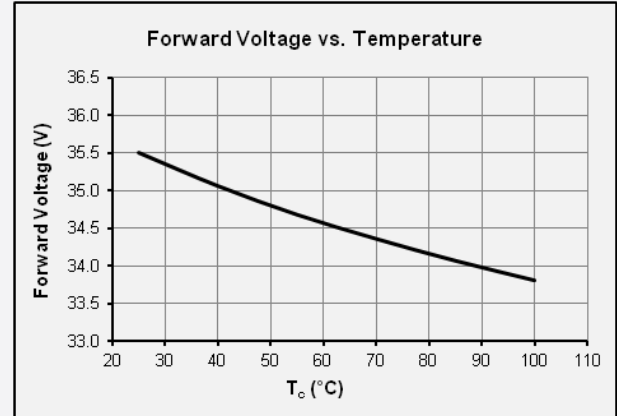
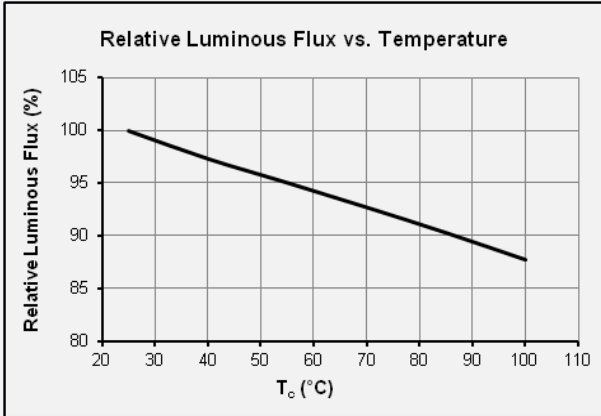

d) Color Shift Characteristics

$T_c = 25^\circ\text{C}$

$I_F = 540 \text{ mA}$

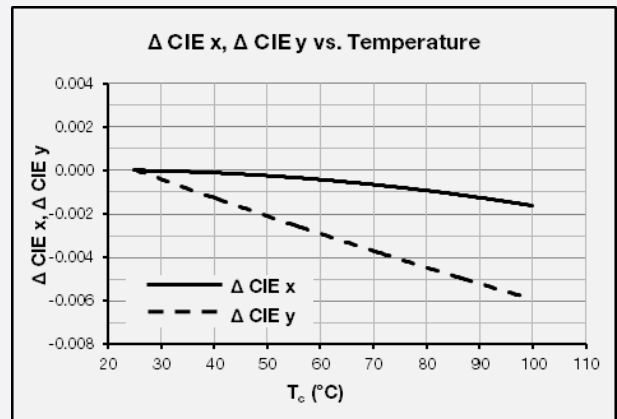
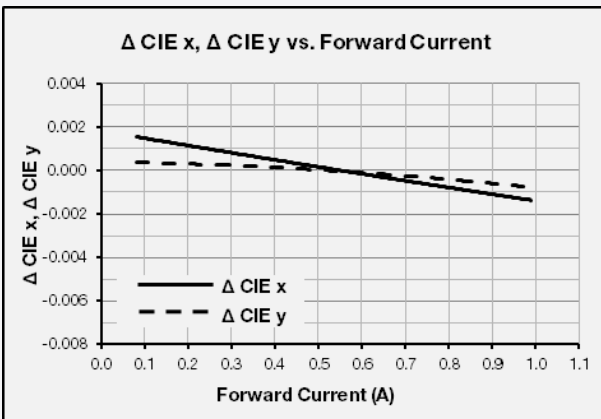

## e) Derating Curve

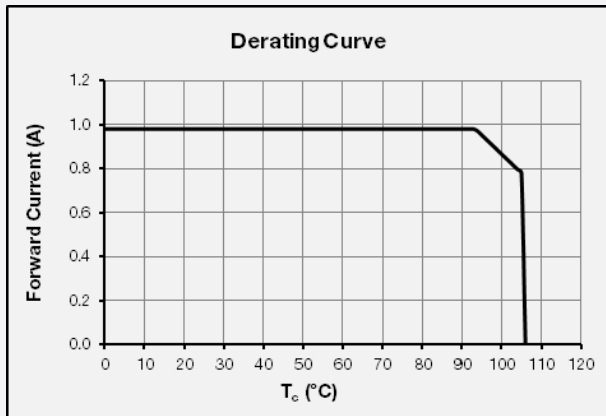
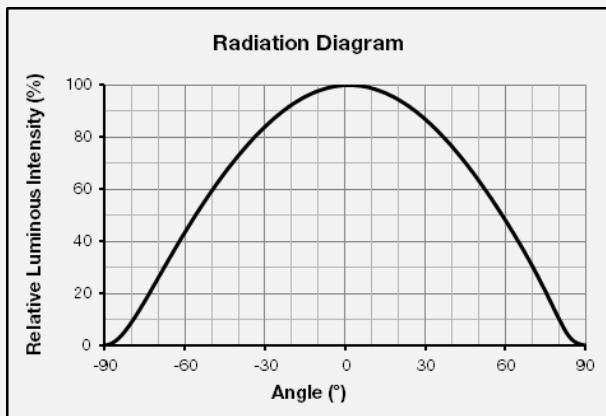
f) Beam Angle Characteristics ( $I_F = 540$  mA,  $T_c = 25$  °C)

### 4. Outline Drawing & Dimension

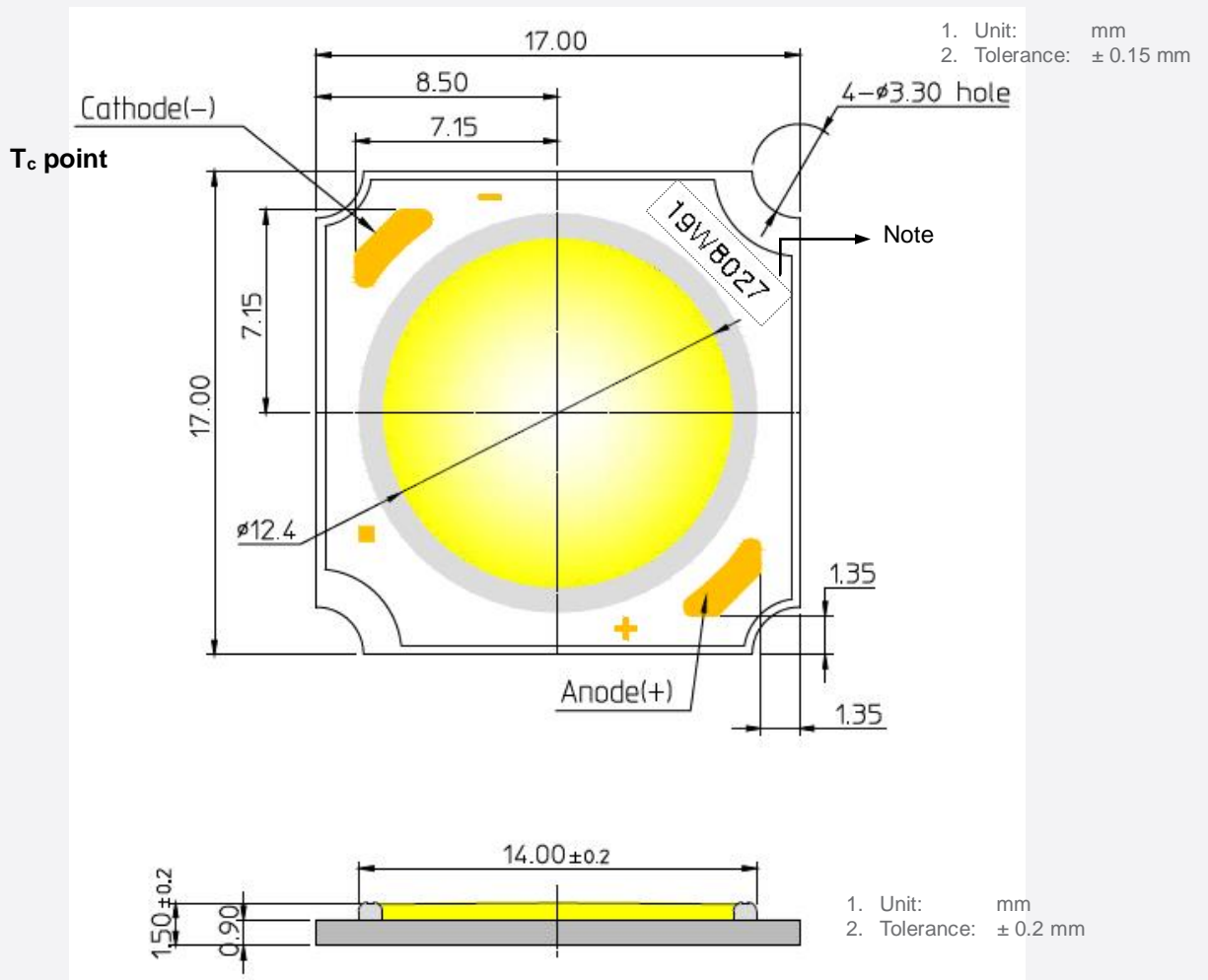

| Item                                  | Dimension | Tolerance  | Unit |
|---------------------------------------|-----------|------------|------|
| Length                                | 17.0      | $\pm 0.15$ | mm   |
| Width                                 | 17.0      | $\pm 0.15$ | mm   |
| Height                                | 1.50      | $\pm 0.20$ | mm   |
| Light Emitting Surface (LES) Diameter | 12.4      | $\pm 0.15$ | mm   |

Note: Denoted product information above is only an example  
( 19W8027 : 19W, CRI80+, 2700K )

## 5. Reliability Test Items & Conditions

### a) Test Items

| Test Item                           | Test Condition  | Test Hour / Cycle |
|-------------------------------------|---|-------------------|
| Room Temperature Life Test          | 25 °C, I <sub>F</sub> = max   | 1000 h            |
| High Temperature Humidity Life Test | 85 °C, 85 % RH, DC Derating, I <sub>F</sub> = max   | 1000 h            |
| High Temperature Life Test          | 105 °C, DC Derating, I <sub>F</sub> = max   | 1000 h            |
| Low Temperature Life Test           | -40 °C, DC 980 mA   | 1000 h            |
| High Temperature Storage            | 120 °C  | 1000 h            |
| Low Temperature Storage             | -40 °C  | 1000 h            |
| Thermal Shock                       | -45 °C / 15 min ↔ 125 °C / 15 min<br>temperature change in 5 min  | 200 cycles        |
| Temperature Cycle On/Off Test       | -40 °C / 85 °C each 20 min, 100 min transfer<br>power on/off each 5 min, DC 540 mA  | 100 cycles        |
| Temperature Humidity Storage Test   | -10 °C ↔ 25 °C, 95 % RH ↔ 85 °C, 95 % RH<br>(24 h / cycle)  | 100 cycles        |
| ESD (HBM)                           | R <sub>1</sub> : 10 MΩ<br>R <sub>2</sub> : 1.5 kΩ<br>C: 100 pF<br>V: ±2 kV  | 5 times           |
| ESD (MM)                            | R <sub>1</sub> : 10 MΩ<br>R <sub>2</sub> : 0 kΩ<br>C: 200 pF<br>V: ±0.5 kV  | 5 times           |
| Vibration Test                      | 20 ~ 80 Hz (displacement: 0.06 inch, max. 20 g)<br>80 ~ 2 kHz (max. 20 g)<br>min. frequency ↔ max. frequency 4 min transfer | 4 times           |
| Mechanical Shock Test               | 1500 g, 0.5 ms<br>each of the 6 surfaces (3 axis x 2 sides)   | 5 times           |
| Salt Spray Test                     | 35 °C, 5 % salt water<br>8 h spray, 16 h dwell  | 2 cycles          |

### b) Criteria for Judging the Damage

| Item            | Symbol         | Test Condition<br>(T <sub>c</sub> = 25 °C) | Limit        |              |
|-----------------|----------------|--|--------------|--------------|
|                 |                |  | Min.         | Max.         |
| Forward Voltage | V <sub>F</sub> | I <sub>F</sub> = 540 mA                    | L.S.L. * 0.9 | U.S.L. * 1.1 |
| Luminous Flux   | Φ <sub>v</sub> | I <sub>F</sub> = 540 mA                    | L.S.L. * 0.7 | U.S.L. * 1.3 |

## 6. Label Structure

### a) Label Structure

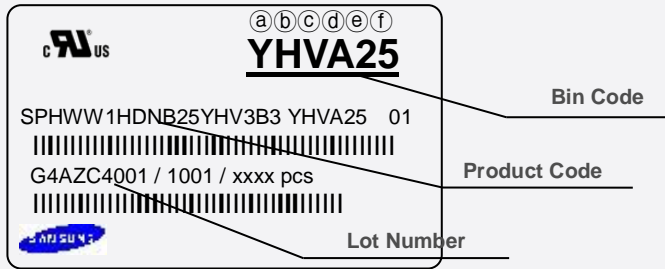

Note: Denoted bin code and product code above is only an example (see description on page 5)

Bin Code:

- ⒶⒷ: Forward Voltage bin (refer to page 11)
- ⒸⒹ: Chromaticity bin (refer to page 9-10)
- ⒺⒻ: Luminous Flux bin (refer to page 6)

### b) Lot Number

The lot number is composed of the following characters:

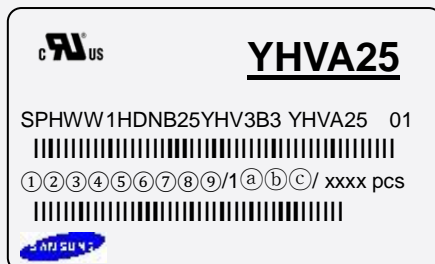

① ③④⑤⑥⑦⑧⑨ / 1ⒶⒷⒸ / xxxx pcs

- ① : Production site (S: Giheung, Korea, G: Tianjin, China)
- ② : 4 (LED)
- ③ : Product state (A: Normal, B: Bulk, C: First Production, R: Reproduction, S: Sample)
- ④ : Year (Z: 2015, A: 2016, B: 2017...)
- ⑤ : Month (1~9, A, B, C)
- ⑥⑦⑧⑨ : Day (1~9, A, B~V)
- ⒶⒷⒸ : Product serial number (001 ~ 999)

## 7. Packing Structure

| Packing material | Max. quantity in pcs of COB | Dimension (mm) |       |        |           |
|------------------|-----------------------------|----------------|-------|--------|-----------|
|                  |                             | Length         | Width | Height | Tolerance |
| Tray             | 40                          | 260            | 190   | 11.5   | 1.0       |
| Anti-static Bag  | 200 (6 trays)               | 387            | 350   | -      | 10.0      |
| Box              | 1,400 (7 anti-static bag)   | -              | -     | -      | -         |

### a) Packing Structure

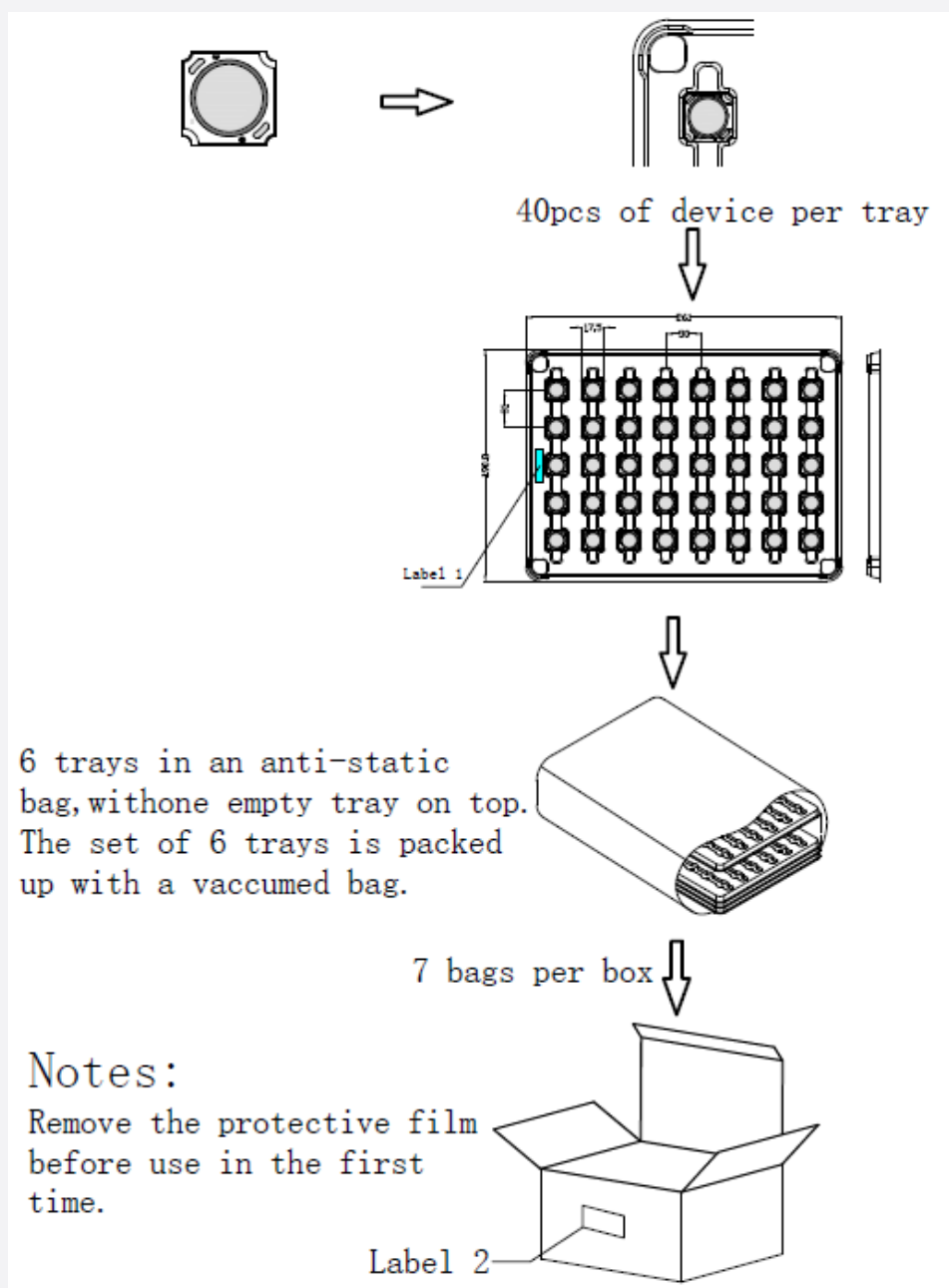

## b) Tray

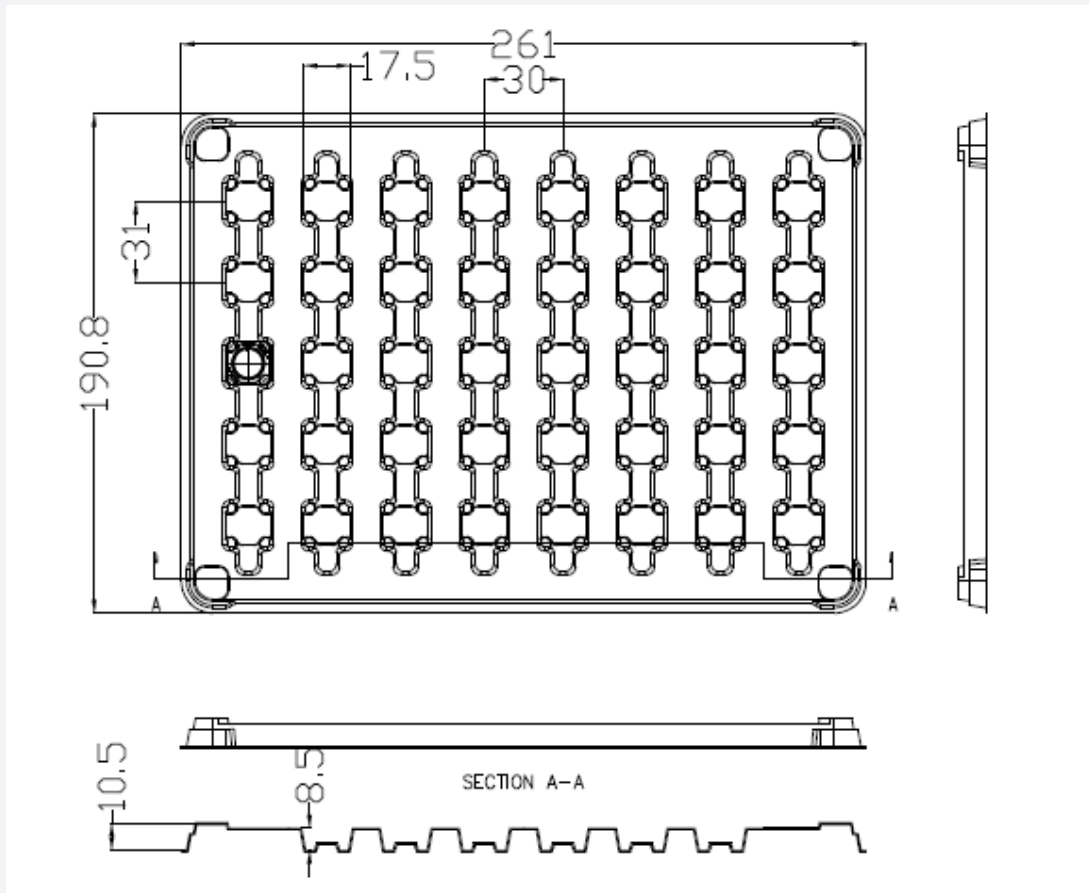

## c) Anti-static Bag

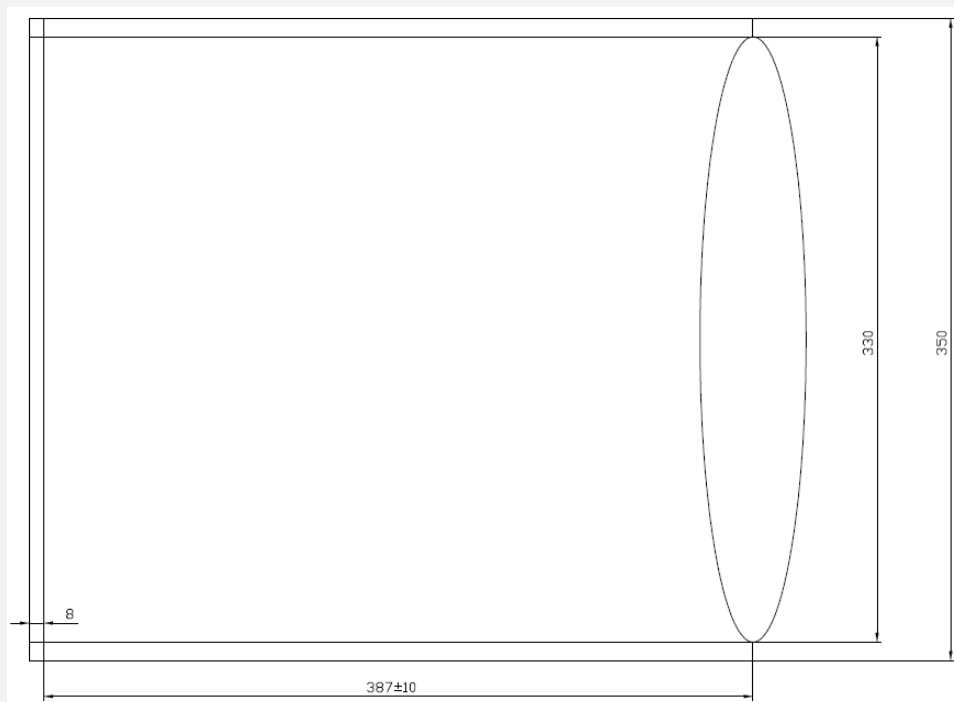

## 8. Precautions in Handling & Use

- 1) This device should not be used in any type of fluid such as water, oil, organic solvent, etc. When cleaning is required, IPA is recommended as the cleaning agent. Some solvent-based cleaning agent may damage the silicone resins used in the device.
- 2) LEDs must be stored in a clean environment. If the LEDs are to be stored for three months or more after being shipped from Samsung, they should be packed with a nitrogen-filled container (shelf life of sealed bags is 12 months at temperature 0~40 °C, 0~90 % RH).
- 3) After storage bag is opened, device subjected to soldering, solder reflow, or other high temperature processes must be:
  - a. Mounted within 672 hours (28 days) at an assembly line with a condition of no more than 30 °C / 60 % RH, or
  - b. Stored at <10 % RH
- 4) Repack unused products with anti-moisture packing, fold to close any opening and then store in a dry place.
- 5) Devices require baking before mounting, if humidity card reading is >60 % at 23 ± 5 °C.
- 6) Devices must be baked for 1 hour at 60 ± 5 °C, if baking is required.
- 7) The LEDs are sensitive to the static electricity and surge current. It is recommended to use a wrist band or anti-electrostatic glove when handling the LEDs. If voltage exceeding the absolute maximum rating is applied to LEDs, it may cause damage or even destruction to LED devices. Damaged LEDs may show some unusual characteristics such as increase in leakage current, lowered turn-on voltage, or abnormal lighting of LEDs at low current.
- 8) In case of driving the LC019B around the extremely low current level, chips might exhibit different brightness due to the variation in I-V characteristics of each one. This is normal and does not adversely affect the performance of product.
- 9) VOCs (Volatile Organic Compounds) can be generated from adhesives, flux, hardener or organic additives used in luminaires (fixtures). Transparent LED silicone encapsulant is permeable to those chemicals and they may lead to a discoloration of encapsulant when they exposed to heat or light. This phenomenon can cause a significant loss of light emitted (output) from the luminaires. In order to prevent these problems, we recommend users to know the physical properties of materials used in luminaires and they must be carefully selected.
- 10) The resin area is very sensitive, please do not handle, press, touch, rub, clean, or pick by with tweezers on it. Instead, please pick at the handling area as indicated below.

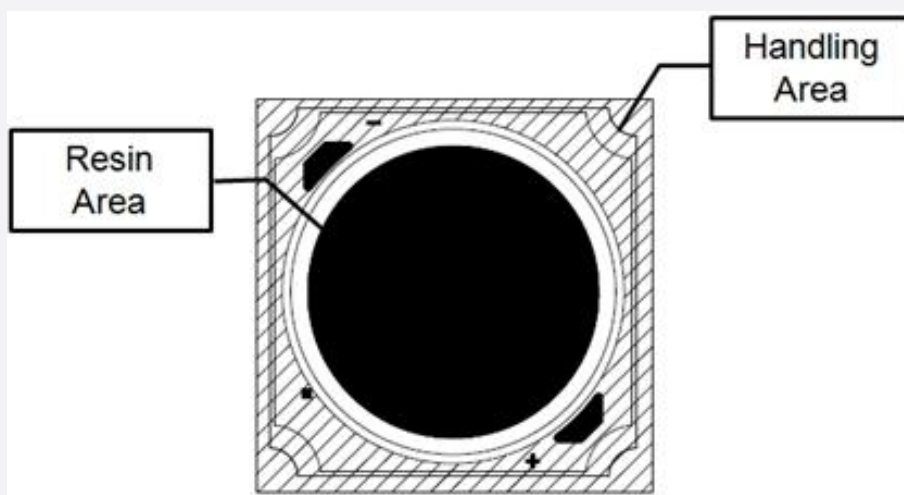

# Legal and additional information.

## [About Samsung Electronics Co., Ltd.](#)

Samsung Electronics Co., Ltd. inspires the world and shapes the future with transformative ideas and technologies, redefining the worlds of TVs, smartphones, wearable devices, tablets, cameras, digital appliances, printers, medical equipment, network systems and semiconductors.

We are also leading in the Internet of Things space through, among others, our Digital Health and Smart Home initiatives. We employ 307,000 people across 84 countries. To discover more, please visit our official website at [www.samsung.com](http://www.samsung.com) and our official blog at [global.samsungtomorrow.com](http://global.samsungtomorrow.com).

Copyright © 2015 Samsung Electronics Co., Ltd. All rights reserved.

Samsung is a registered trademark of Samsung Electronics Co., Ltd.

Specifications and designs are subject to change without notice. Non-metric weights and measurements are approximate. All data were deemed correct at time of creation. Samsung is not liable for errors or omissions. All brand, product, service names and logos are trademarks and/or registered trademarks of their respective owners and are hereby recognized and acknowledged.

Samsung Electronics Co., Ltd.  
95, Samsung 2-ro  
Giheung-gu  
Yongin-si, Gyeonggi-do, 446-711  
KOREA

[www.samsungled.com](http://www.samsungled.com)



## Looking for pricing, stock, or lifecycle information?

Click below to explore more details on WIN SOURCE:

- ⊖ [View SPHWW1HDNB25YHU3B3 on WIN SOURCE](#)
- ⊖ [Samsung Information](#)

## Optimize Your Supply Chain with WIN SOURCE Solutions

- ✓ Global Sourcing Solution
- ✓ Obsolete Management
- ✓ Cost Control Management
- ✓ Shortage Management
- ✓ Alternative Solution
- ✓ Excess Inventory Management