

High Voltage LED Series Chip on Board

LCo19B Gen.2



High efficacy COB LED package,
well-suited for use in spotlight applications

Features & Benefits

- Chip on Board (COB) solution makes it easy to design in
- Simple assembly reduces manufacturing cost
- Low thermal resistance
- InGaN/GaN MQW LED with long time reliability
- Completed 6,000 hours of LM-80 Testing
- ENEC certified: Integral LED Module

Applications

- Spotlight / Downlight
- LED Retrofit Bulbs
- Outdoor Illumination



Table of Contents

1.	Characteristics	-----	3
2.	Product Code Information	-----	6
3.	Typical Characteristics Graphs	-----	12
4.	Outline Drawing & Dimension	-----	15
5.	Reliability Test Items & Conditions	-----	16
6.	Label Structure	-----	17
7.	Packing Structure	-----	19
8.	Precautions in Handling & Use	-----	22

1. Characteristics

a) Absolute Maximum Rating

Item	Symbol	Rating	Unit	Condition
Ambient / Operating Temperature	T_a	-40 ~ +105	°C	-
Storage Temperature	T_{stg}	-40 ~ +120	°C	-
LED Junction Temperature	T_j	150	°C	-
Case Temperature	T_c	105	°C	*Note
Forward Current	I_F	980	mA	-
Power Dissipation	P_D	36.3	W	-
ESD (HBM)	-	±2	kV	-
ESD (MM)	-	±0.5	kV	-

b) Electro-optical Characteristics ($I_F = 540 \text{ mA}$, $T_c = 25 \text{ °C}$)

Item	Unit	Rank	Min.	Typ.	Max.
Forward Voltage (V_F)	V	YH	32.5	35.5	38.5
		3	70	-	-
		5	80	-	-
Color Rendering Index (R_a)	-	7	90	-	-
		8	95	-	-
Thermal Resistance (junction to chip point)	°C/W		-	1.5	-
Beam Angle	°		-	115	-
Nominal Power	W			19.2	
Eye Protection		Risk 1	-		-

Notes:

- 1) The COB is tested in pulsed condition at rated test current (10 ms pulse width) and rated temperature ($T_j = T_c = T_a = 25 \text{ °C}$)
- 2) Samsung maintains measurement tolerance of: forward voltage = $\pm 5 \%$, CRI = ± 1
- 3) Max $T_c = 105 \text{ °C}$ is for ENEC condition. Refer to the derating curve, '3. Typical Characteristics Graph' designed within the range.

c) Luminous Flux Characteristics ($I_F = 540 \text{ mA}$)

CRI (R _s) Min.	Nominal CCT (K)	Flux Rank	Flux Bin	Sorting ¹⁾ @ T _c = 25 °C (lm)		Calculated Flux ²⁾ @ T _c = 85 °C (lm)		
				Min.	Max.	Min.	Max.	
70	3000	2F	21	2388	2714	2149	2443	
			22	2714	3040	2443	2736	
	4000	2F	21	2508	2850	2257	2565	
			22	2850	3192	2565	2872	
	5000	2F	21	2532	2877	2278	2589	
			22	2877	3222	2589	2900	
80	2700	1G	24	2487	2650	2263	2411	
			25	2650	2813	2411	2560	
		1H	25	2650	2813	2411	2560	
	3000	1G	24	2646	2819	2408	2565	
			25	2819	2992	2565	2723	
		1H	25	2819	2992	2565	2723	
	3500	1G	23	2547	2725	2318	2480	
			24	2725	2904	2480	2642	
		1H	24	2725	2904	2480	2642	
			25	2904	3082	2642	2805	
	4000	1G	23	2621	2805	2385	2552	
			24	2805	2988	2552	2719	
		1H	24	2805	2988	2552	2719	
			25	2988	3172	2719	2886	
		5000	1G	23	2646	2831	2408	2576
				24	2831	3016	2576	2745
	1H		24	2831	3016	2576	2745	
	5700	1H	25	3016	3202	2745	2914	
			1G	23	2646	2831	2408	2576
				24	2831	3016	2576	2745
		1H	24	2831	3016	2576	2745	
			1H	24	2831	3016	2576	2745
				25	3016	3202	2745	2914

c) Luminous Flux Characteristics (I_F = 540 mA)

CRI (R _a) Min.	Nominal CCT (K)	Flux Rank	Flux Bin	Sorting ¹⁾ @ T _c = 25 °C (lm)		Calculated Flux ²⁾ @ T _c = 85 °C (lm)		
				Min.	Max.	Min.	Max.	
90	2700	2K	23	2084	2251	1897	2048	
			24	2251	2481	2048	2258	
	3000	2K	23	2127	2297	1935	2090	
			24	2297	2527	2090	2299	
	3500	2K	23	2191	2366	1993	2153	
			24	2366	2596	2153	2362	
	4000	2K	23	2254	2435	2051	2216	
			24	2435	2665	2216	2425	
	95	2700	1F	11	1714	1905	1560	1733
				12	1905	2095	1733	1907
3000		1F	11	1767	1964	1608	1787	
			12	1964	2160	1787	1966	
3500		1F	11	1820	2023	1657	1841	
			12	2023	2225	1841	2025	

Notes:

- 1) The COB is tested in pulsed condition at rated test current (10 ms pulse width) and rated temperature (T_j = T_c = T_a = 25 °C)
- 2) Calculated flux values are for reference only
- 3) Samsung maintains measurement tolerance of: luminous flux = ±7 %, CRI = ±1

2. Product Code Information

1	2	3	4	5	6	7	8	9	10	11	12	13	14	15	16	17	18
S	P	H	C	W	1	H	D	N	B	2	5	Y	H	R	T	2	J

Digit	PKG Information	Code	Specification	
1 2 3	Samsung Package High Power	SPH		
4 5	Color	WW CW	Warm White (T/U/V/W Ranks) Cool White (Q/R Ranks)	
6	Product Version	1		
7 8	Form Factor	HD	COB	
9	Lens Type	N	No lens	
10	Internal Code	B	LC019	
11	Chip Type	2		
12	CRI & Sorting Temperature	3 5 7 8	Min. 70 Min. 80 Min. 90 Min 95	25 °C
13 14	Forward Voltage (V)	YH	32.5~38.5	
15	CCT (K)	W V U T R Q	2700 K 3000 K 3500 K 4000 K 5000 K 5700 K	WA, WB (MacAdam Ellipse) VA, VB (MacAdam Ellipse) UA, UB (MacAdam Ellipse) TA, TB (MacAdam Ellipse) RA (MacAdam Ellipse) Bin Code: TW, TX, TY, TZ (ANSI bin) RW, RX, RY, RZ (ANSI bin) QW, QX, QY, QZ (ANSI bin) VW, VX, VY, VZ (ANSI bin)
16	MacAdam / ANSI	2 3 T	MacAdam 2-step MacAdam 3-step ANSI bin	
17 18	Luminous Flux	1F 1G 1H 2F 2K	11, 12 (95 CRI) 23, 24, 25 (80 CRI) Bin Code: 24, 25 (80 CRI) 21, 22 (70 CRI) 23, 24 (90 CRI)	

a) Binning Structure ($I_F = 540 \text{ mA}$, $T_c = 25 \text{ }^\circ\text{C}$)

CRI (R_a) Min.	Nominal CCT (K)	Product Code	V_F Rank	Color Rank	Chrom. Bin	Flux Rank	Flux Bin	Flux Range (Φ_v , lm)	
70	3000	SPHWW1HDNB23YHVT2F	YH	VT	VW, VX VY, VZ	2F	21	2388 ~ 2714	
							22	2714 ~ 3040	
		4000	SPHWW1HDNB23YHTT2F	YH	TT	TW, TX TY, TZ	2F	21	2508 ~ 2850
	5000	SPHCW1HDNB23YHRT2F	YH	RT	RW, RX RY, RZ	2F	21	2532 ~ 2877	
							22	2877 ~ 3222	
	80	2700	SPHWW1HDNB25YHW21G	YH	W2	WB	1G	24	2487 ~ 2650
								25	2650 ~ 2813
			SPHWW1HDNB25YHW31G	YH	W3	WA, WB	1G	24	2487 ~ 2650
								25	2650 ~ 2813
SPHWW1HDNB25YHW21H			YH	W2	WB	1H	25	2650 ~ 2813	
SPHWW1HDNB25YHW31H			YH	W3	WA, WB	1H	25	2650 ~ 2813	
3000		SPHWW1HDNB25YHV21G	YH	V2	VB	1G	24	2646 ~ 2819	
							25	2819 ~ 2992	
		SPHWW1HDNB25YHV31G	YH	V3	VA, VB	1G	24	2646 ~ 2819	
							25	2819 ~ 2992	
		SPHWW1HDNB25YHV21H	YH	W2	WB	1H	25	2819 ~ 2992	
		SPHWW1HDNB25YHV31H	YH	W3	WA, WB	1H	25	2819 ~ 2992	
3500		SPHWW1HDNB25YHU21G	YH	U2	UB	1G	23	2547 ~ 2725	
							24	2725 ~ 2904	
		SPHWW1HDNB25YHU31G	YH	U3	UA, UB	1G	23	2547 ~ 2725	
							24	2725 ~ 2904	
		SPHWW1HDNB25YHU21H	YH	U2	UB	1H	24	2725 ~ 2904	
							25	2904 ~ 3082	
4000	SPHWW1HDNB25YHU31H	YH	U3	UA, UB	1H	24	2725 ~ 2904		
						25	2904 ~ 3082		
	SPHWW1HDNB25YHT21G	YH	T2	TB	1G	23	2621 ~ 2805		
						24	2805 ~ 2988		
	SPHWW1HDNB25YHT31G	YH	T3	TA, TB	1G	23	2621 ~ 2805		
						24	2805 ~ 2988		
5000	SPHWW1HDNB25YHT21H	YH	T2	TB	1H	24	2805 ~ 2988		
						25	2988 ~ 3172		
	SPHWW1HDNB25YHT31H	YH	T3	TA, TB	1H	24	2805 ~ 2988		
						25	2988 ~ 3172		
	SPHCW1HDNB25YHR31G	YH	R3	RA	1G	23	2646 ~ 2831		
						24	2831 ~ 3016		
5700	SPHCW1HDNB25YHRT1G	YH	RT	RW, RX, RY, RZ	1G	23	2646 ~ 2831		
						24	2831 ~ 3016		
	SPHCW1HDNB25YHR31H	YH	R3	RA	1H	24	2831 ~ 3016		
						25	3016 ~ 3202		
5700	SPHCW1HDNB25YHRT1H	YH	RT	RW, RX, RY, RZ	1H	24	2831 ~ 3016		
						25	3016 ~ 3202		
	SPHCW1HDNB25YHQT1G	YH	QT	QW, QX QY, QZ	1G	23	2646 ~ 2831		
					24	2831 ~ 3016			
	SPHCW1HDNB25YHQT1H	YH	QT	QW, QX QY, QZ	1H	24	2831 ~ 3016		
					25	3016 ~ 3202			

a) Binning Structure ($I_F = 540 \text{ mA}$, $T_c = 25 \text{ }^\circ\text{C}$)

CRI (R _a) Min.	Nominal CCT (K)	Product Code	V _F Rank	Color Rank	Chrom. Bin	Flux Rank	Flux Bin	Flux Range (Φ _v , lm)
90	2700	SPHWW1HDNB27YHW22K	YH	W2	WB	2K	23	2084 ~ 2251
							24	2251 ~ 2481
		SPHWW1HDNB27YHW32K	YH	W3	WA, WB	2K	23	2084 ~ 2251
							24	2251 ~ 2481
	3000	SPHWW1HDNB27YHV22K	YH	V2	VB	2K	23	2127 ~ 2297
							24	2297 ~ 2527
		SPHWW1HDNB27YHV32K	YH	V3	VA, VB	2K	23	2127 ~ 2297
							24	2297 ~ 2527
	3500	SPHWW1HDNB27YHU22K	YH	U2	UB	2K	23	2191 ~ 2366
							24	2366 ~ 2596
		SPHWW1HDNB27YHU32K	YH	U3	UA, UB	2K	23	2191 ~ 2366
							24	2366 ~ 2596
	4000	SPHWW1HDNB27YHT22K	YH	T2	TB	2K	23	2254 ~ 2435
							24	2435 ~ 2665
		SPHWW1HDNB27YHT32K	YH	T3	TA, TB	2K	23	2254 ~ 2435
							24	2435 ~ 2665
95	2700	SPHWW1HDNB28YHW21F	YH	W2	WB	1F	11	1714 ~ 1905
							12	1905 ~ 2095
		SPHWW1HDNB28YHW31F	YH	W3	WA, WB	1F	11	1714 ~ 1905
							12	1905 ~ 2095
	3000	SPHWW1HDNB28YHV21F	YH	V2	VB	1F	11	1767 ~ 1964
							12	1964 ~ 2160
		SPHWW1HDNB28YHV31F	YH	V3	VA, VB	1F	11	1767 ~ 1964
							12	1964 ~ 2160
	3500	SPHWW1HDNB28YHU21F	YH	U2	UB	1F	11	1820 ~ 2023
							12	2023 ~ 2225
	SPHWW1HDNB28YHU31F	YH	U3	UA, UB	1F	11	1820 ~ 2023	
						12	2023 ~ 2225	

b) Chromaticity Region & Coordinates ($I_F = 540 \text{ mA}$, $T_a = 25 \text{ }^\circ\text{C}$)

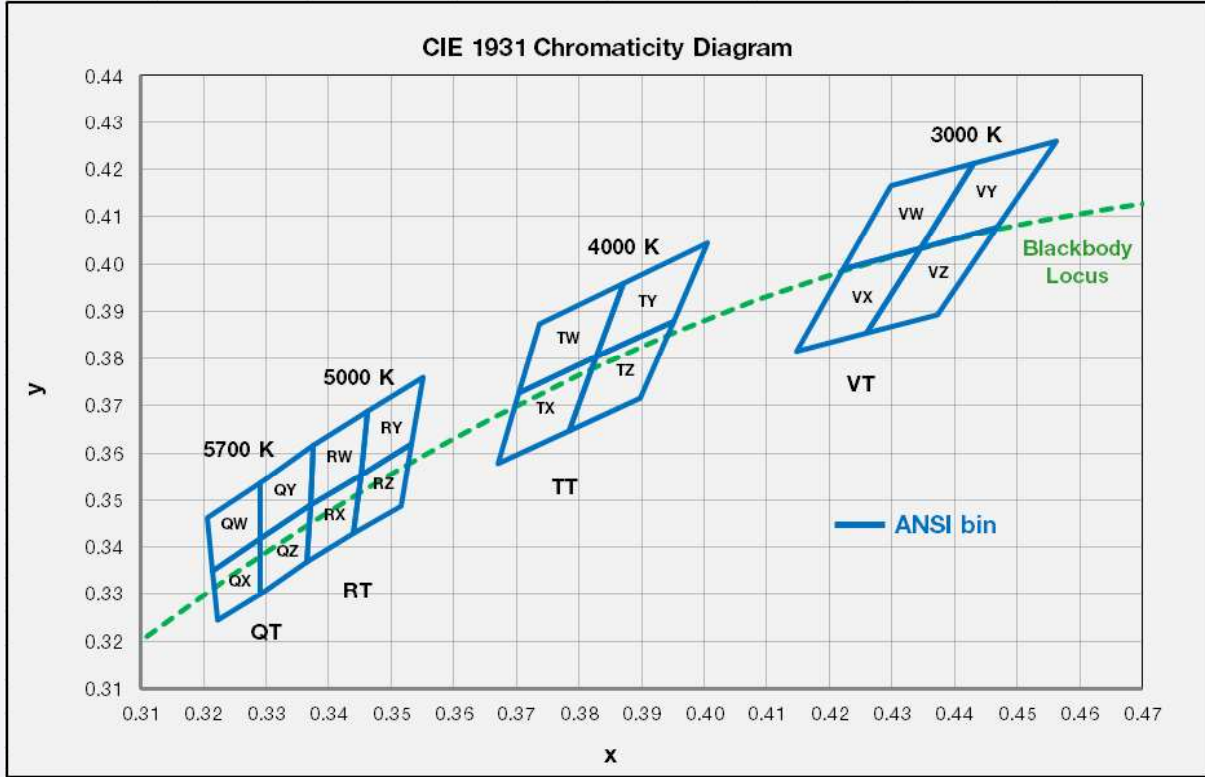

Region	CIE x	CIE y	Region	CIE x	CIE y
V rank (3000 K)					
VW	0.4223	0.399	VY	0.4345	0.4033
	0.4345	0.4033		0.4468	0.4077
	0.4431	0.4213		0.4562	0.4260
VX	0.4299	0.4165	VZ	0.4431	0.4213
	0.4223	0.399		0.4260	0.3854
	0.4147	0.3814		0.4373	0.3893
	0.4260	0.3854		0.4468	0.4077
	0.4345	0.4033		0.4345	0.4033
R rank (5000 K)					
RW	0.3376	0.3616	RY	0.3463	0.3687
	0.3463	0.3687		0.3551	0.3760
	0.3451	0.3554		0.3533	0.3620
	0.3371	0.3490		0.3451	0.3554
RX	0.3371	0.3490	RZ	0.3451	0.3554
	0.3451	0.3554		0.3533	0.3620
	0.3440	0.3428		0.3515	0.3487
	0.3366	0.3369		0.3440	0.3428

Region	CIE x	CIE y	Region	CIE x	CIE y
T rank (4000 K)					
TW	0.3736	0.3874	TY	0.3871	0.3959
	0.3871	0.3959		0.4006	0.4044
	0.3828	0.3803		0.3952	0.388
	0.3703	0.3726		0.3828	0.3803
TX	0.3703	0.3726	TZ	0.3828	0.3803
	0.3828	0.3803		0.3952	0.388
	0.3784	0.3647		0.3898	0.3716
	0.367	0.3578		0.3784	0.3647
Q rank (5700 K)					
QW	0.3207	0.3462	QY	0.3290	0.3538
	0.3290	0.3538		0.3376	0.3616
	0.3290	0.3417		0.3371	0.3490
	0.3215	0.3350		0.3290	0.3417
QX	0.3215	0.3350	QZ	0.3290	0.3417
	0.3290	0.3417		0.3371	0.3490
	0.3290	0.3300		0.3366	0.3369
	0.3222	0.3243		0.3290	0.3300



b) Chromaticity Region & Coordinates ($I_F = 540 \text{ mA}$, $T_a = 25 \text{ }^\circ\text{C}$)



MacAdam Ellipse (WA, WB)					
Step	CIE x	CIE y	θ	a	b
2-step	0.4578	0.4101	53.70	0.0054	0.0028
3-step	0.4578	0.4101	53.70	0.0081	0.0042

MacAdam Ellipse (VA, VB)					
Step	CIE x	CIE y	θ	a	b
2-step	0.4338	0.403	53.22	0.0056	0.0027
3-step	0.4338	0.4030	53.22	0.0083	0.0041

MacAdam Ellipse (UA, UB)					
Step	CIE x	CIE y	θ	a	b
2-step	0.4073	0.3917	54.00	0.0062	0.0028
3-step	0.4073	0.3917	54.00	0.0093	0.0041

MacAdam Ellipse (TA, TB)					
Step	CIE x	CIE y	θ	a	b
2-step	0.3818	0.3797	53.72	0.0063	0.0027
3-step	0.3818	0.3797	53.72	0.0094	0.0040

MacAdam Ellipse (RA)					
Step	CIE x	CIE y	θ	a	b
3-step	0.3447	0.3553	59.62	0.0082	0.0035

Note:

Samsung maintains measurement tolerance of: $C_x, C_y = \pm 0.005$



3. Typical Characteristics Graphs

a) Spectrum Distribution ($I_F = 540 \text{ mA}$, $T_c = 25^\circ \text{C}$)

CCT: 2700 K



CCT: 3000 K

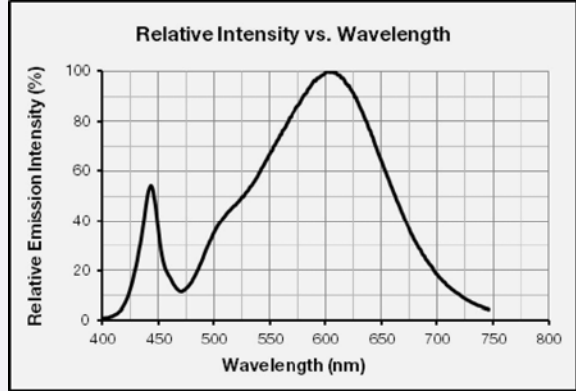

CCT: 3500 K



CCT: 4000 K

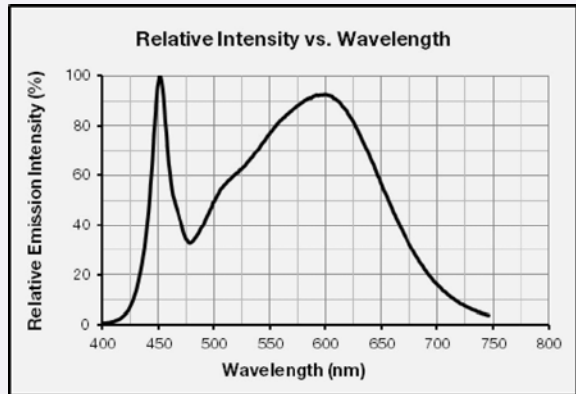

CCT: 5000 K



CCT: 5700 K

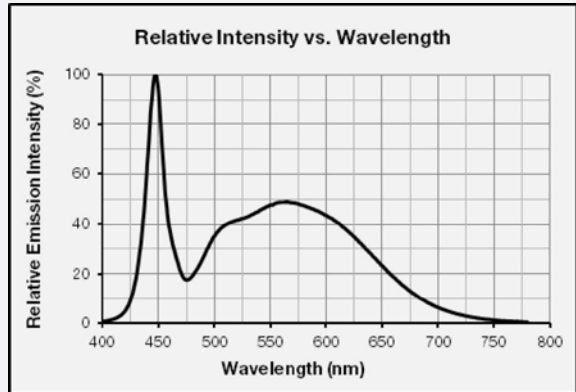

b) Forward Current Characteristics ($T_c = 25^\circ\text{C}$)

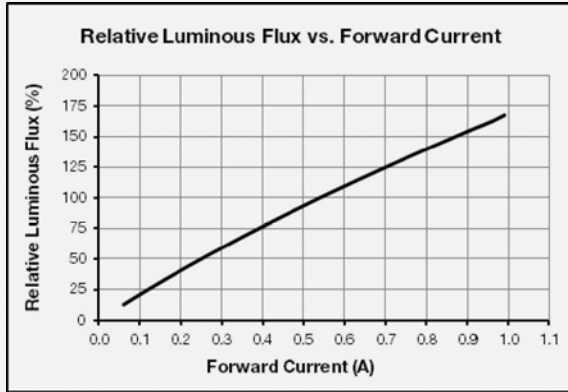

c) Temperature Characteristics ($I_f = 540\text{ mA}$)

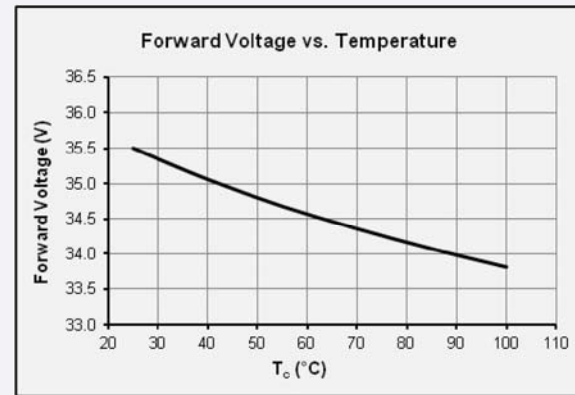
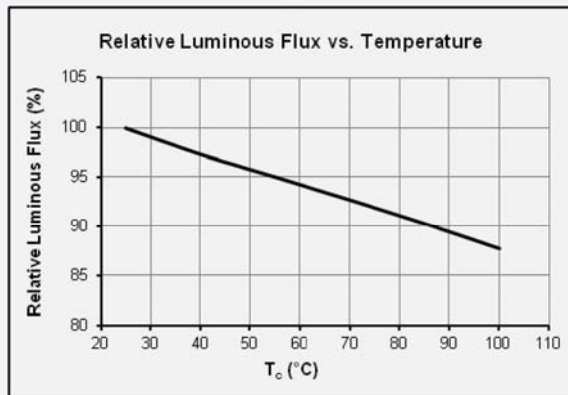

d) Color Shift Characteristics

$T_c = 25^\circ\text{C}$

$I_f = 540\text{ mA}$

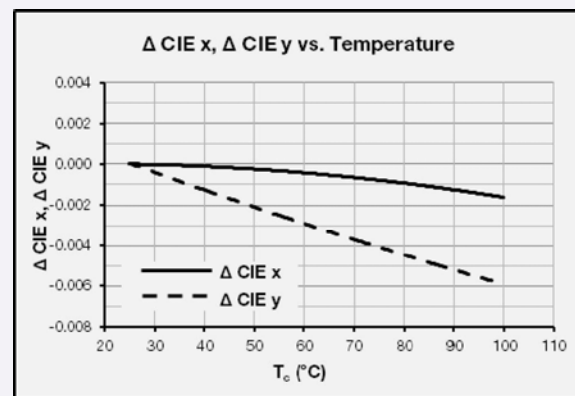
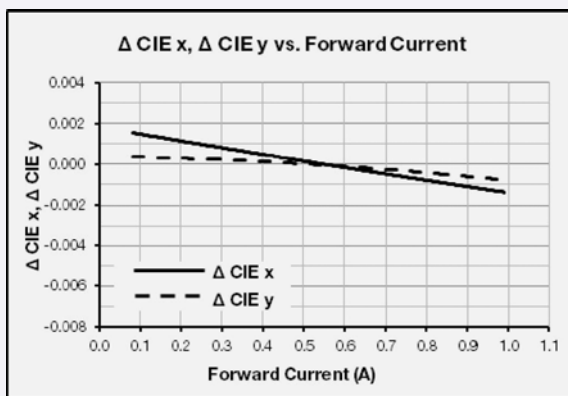

e) Derating Curve

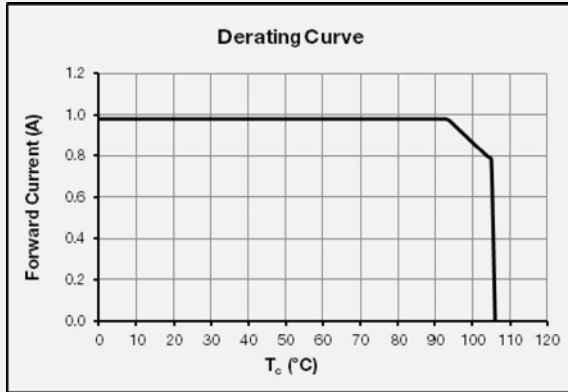
f) Beam Angle Characteristics ($I_F = 540$ mA, $T_c = 25$ °C)

4. Outline Drawing & Dimension

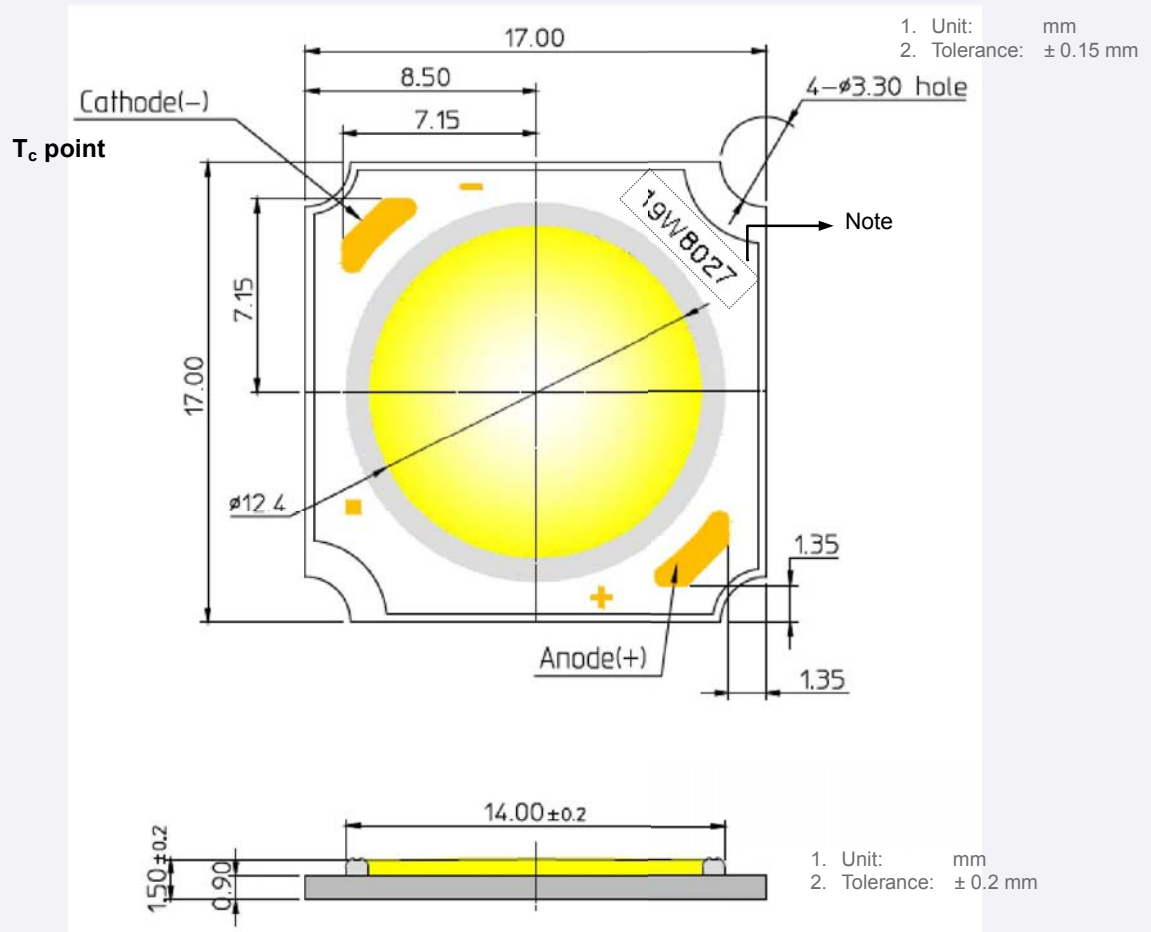

Item	Dimension	Tolerance	Unit
Length	17.0	± 0.15	mm
Width	17.0	± 0.15	mm
Height	1.50	± 0.20	mm
Light Emitting Surface (LES) Diameter	12.4	± 0.15	mm

Note: Denoted product information above is only an example
(19W8027 : 19W, CRI80+, 2700K)

5. Reliability Test Items & Conditions

a) Test Items

Test Item	Test Condition	Test Hour / Cycle
Room Temperature Life Test	25 °C, $I_F = \text{max}$	1000 h
High Temperature Humidity Life Test	85 °C, 85 % RH, DC Derating, $I_F = \text{max}$	1000 h
High Temperature Life Test	105 °C, DC Derating, $I_F = \text{max}$	1000 h
Low Temperature Life Test	-40 °C, DC 980 mA	1000 h
High Temperature Storage	120 °C	1000 h
Low Temperature Storage	-40 °C	1000 h
Thermal Shock	-45 °C / 15 min ↔ 125 °C / 15 min temperature change in 5 min	200 cycles
Temperature Cycle On/Off Test	-40 °C / 85 °C each 20 min, 100 min transfer power on/off each 5 min, DC 540 mA	100 cycles
Temperature Humidity Storage Test	-10 °C ↔ 25 °C, 95 % RH ↔ 85 °C, 95 % RH (24 h / cycle)	100 cycles
ESD (HBM)	R_1 : 10 MΩ R_2 : 1.5 kΩ C: 100 pF V: ±2 kV	5 times
ESD (MM)	R_1 : 10 MΩ R_2 : 0 kΩ C: 200 pF V: ±0.5 kV	5 times
Vibration Test	20 ~ 80 Hz (displacement: 0.06 inch, max. 20 g) 80 ~ 2 kHz (max. 20 g) min. frequency ↔ max. frequency 4 min transfer	4 times
Mechanical Shock Test	1500 g, 0.5 ms each of the 6 surfaces (3 axis x 2 sides)	5 times
Salt Spray Test	35 °C, 5 % salt water 8 h spray, 16 h dwell	2 cycles

b) Criteria for Judging the Damage

Item	Symbol	Test Condition ($T_C = 25\text{ °C}$)	Limit	
			Min.	Max.
Forward Voltage	V_F	$I_F = 540\text{ mA}$	L.S.L. * 0.9	U.S.L. * 1.1
Luminous Flux	Φ_v	$I_F = 540\text{ mA}$	L.S.L. * 0.7	U.S.L. * 1.3

6. Label Structure

a) Label Structure

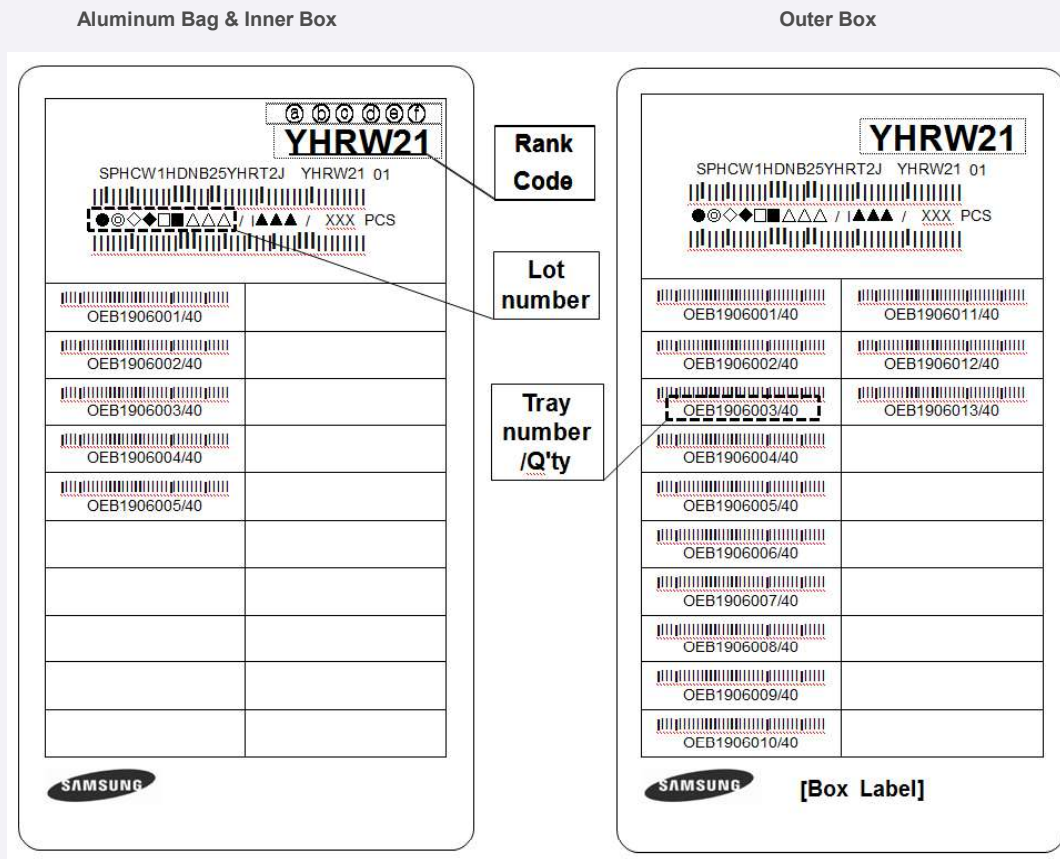

Note: Denoted rank code and product code above is only an example (see description on page 5)

Rank Code:

ⒶⒷ: Forward Voltage rank (refer to page 6-7)

ⒸⒹ: Chromaticity bin (refer to page 8-9)

ⒺⒻ: Luminous Flux bin (refer to page 6-7)

b) Lot Number

The lot number is composed of the following characters:

●◎◇◆□■△△△ / 1▲▲▲ / xxx PCS

- : Production site (S: Giheung, Korea, G: Tianjin, China)
- ◎ : L (LED)
- ◇ : Product state (A: Normal, B: Bulk, C: First Production, R: Reproduction, S: Sample)
- ◆ : Year (Y: 2014, Z: 2015, A: 2016, ...)
- : Month (1~9, A, B, C)
- : Day (1~9, A, B~V)
- △△△ : Product serial number (001 ~ 009)
- ▲▲▲ : Tray number (001 ~ 999)

7. Packing Structure

Packing material	Max. quantity in pcs of COB	Dimension (mm)			
		Length	Width	Height	Tolerance
Tray	60	322.6	135.9	10.8	1.0
Aluminum Bag	480 (8 trays)	450	230	-	10
PE Foam Pad	-	280	130	10	2
Inner Box	480 (1 aluminum bag)	338	148	55	2
Outer Box	1,920 (4 inner boxes)	351	308	120	5
Pallet	107,520 (56 outer boxes)	1000	1000	130	10

a) Packing Structure

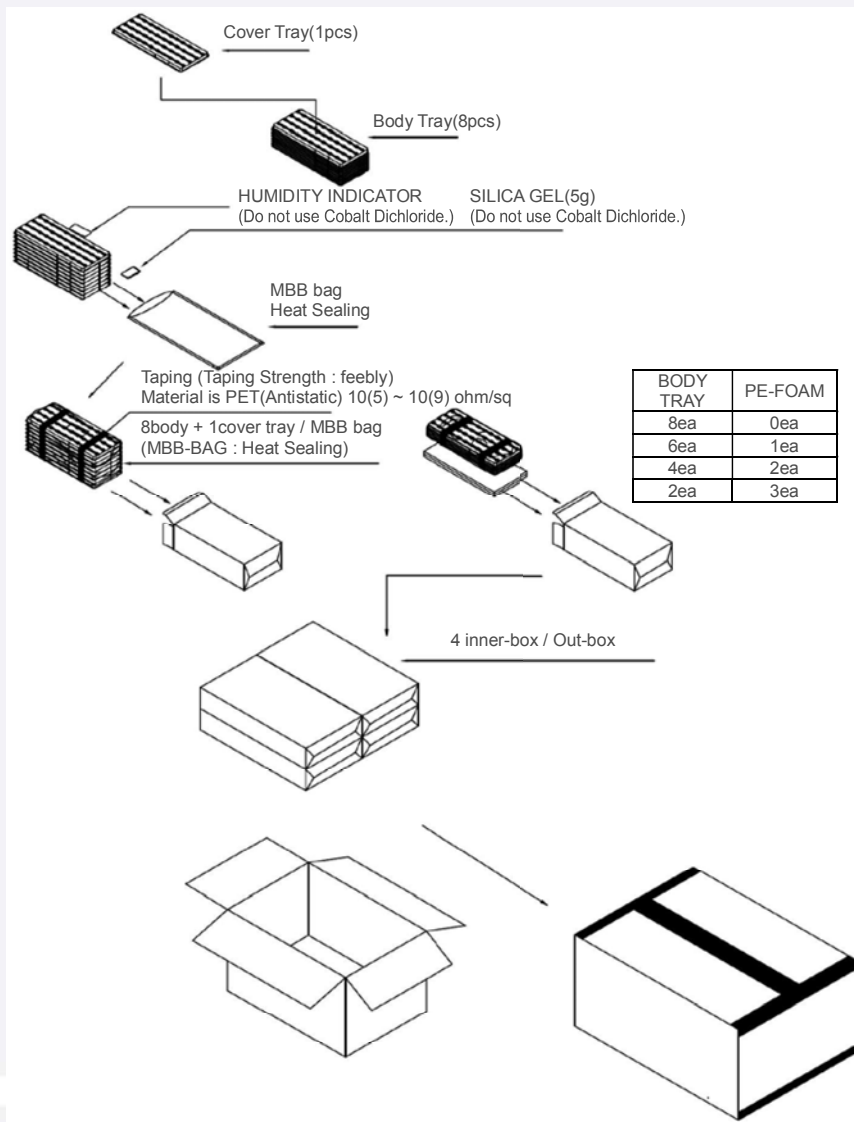

b) Tray

① COVER

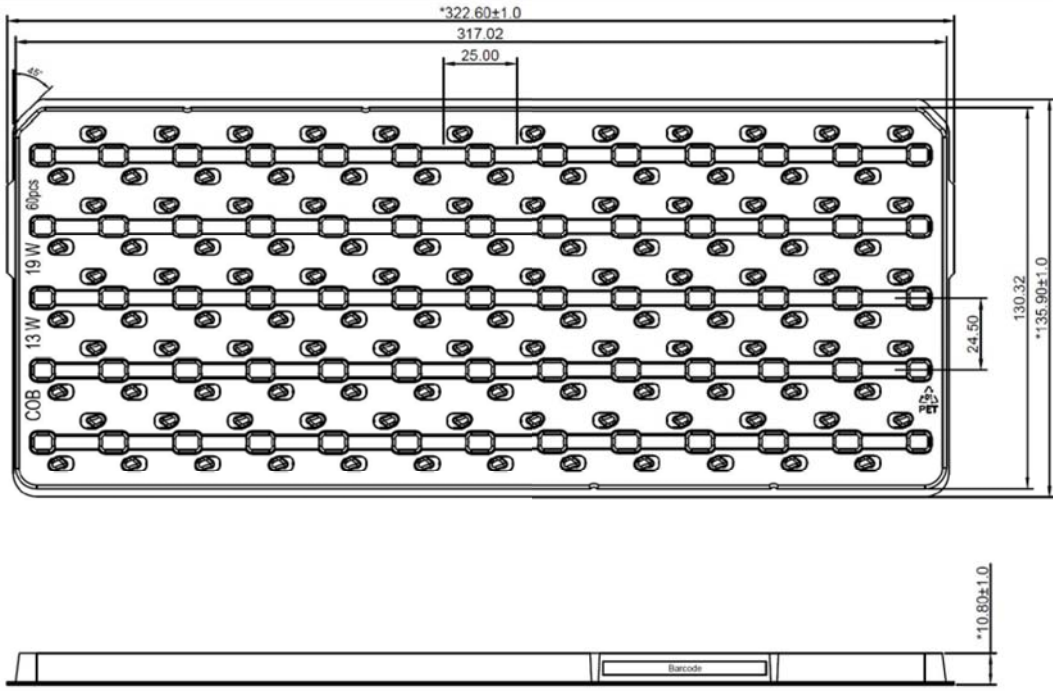

② BODY

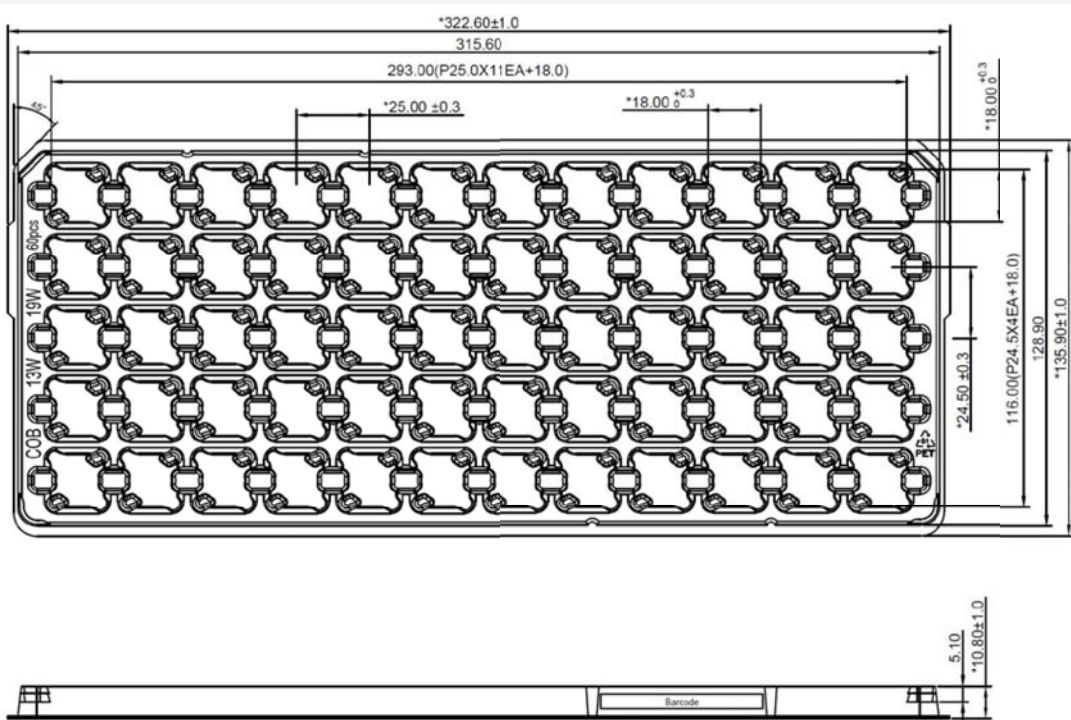

c) Aluminum Vinyl Packing Bag



d) Silica Gel & Humidity Indicator Card inside Aluminum Vinyl Packing Bag



8. Precautions in Handling & Use

- 1) This device should not be used in any type of fluid such as water, oil, organic solvent, etc. When cleaning is required, IPA is recommended as the cleaning agent. Some solvent-based cleaning agent may damage the silicone resins used in the device.
- 2) LEDs must be stored in a clean environment. If the LEDs are to be stored for three months or more after being shipped from Samsung, they should be packed with a nitrogen-filled container (shelf life of sealed bags is 12 months at temperature 0~40 °C, 0~90 % RH).
- 3) After storage bag is opened, device subjected to soldering, solder reflow, or other high temperature processes must be:
 - a. Mounted within 672 hours (28 days) at an assembly line with a condition of no more than 30 °C / 60 % RH, or
 - b. Stored at <10 % RH
- 4) Repack unused products with anti-moisture packing, fold to close any opening and then store in a dry place.
- 5) Devices require baking before mounting, if humidity card reading is >60 % at 23 ± 5 °C.
- 6) Devices must be baked for 1 hour at 60 ± 5 °C, if baking is required.
- 7) The LEDs are sensitive to the static electricity and surge current. It is recommended to use a wrist band or anti-electrostatic glove when handling the LEDs. If voltage exceeding the absolute maximum rating is applied to LEDs, it may cause damage or even destruction to LED devices. Damaged LEDs may show some unusual characteristics such as increase in leakage current, lowered turn-on voltage, or abnormal lighting of LEDs at low current.
- 8) VOCs (Volatile Organic Compounds) can be generated from adhesives, flux, hardener or organic additives used in luminaires (fixtures). Transparent LED silicone encapsulant is permeable to those chemicals and they may lead to a discoloration of encapsulant when they exposed to heat or light. This phenomenon can cause a significant loss of light emitted (output) from the luminaires. In order to prevent these problems, we recommend users to know the physical properties of materials used in luminaires and they must be carefully selected.
- 9) The resin area is very sensitive, please do not handle, press, touch, rub, clean, or pick by with tweezers on it. Instead, please pick at the handling area as indicated below.



Looking for pricing, stock, or lifecycle information?

Click below to explore more details on WIN SOURCE:

 [View SPHCW1HDNB25YHQT1G on WIN SOURCE](#)

 [Samsung Information](#)

Optimize Your Supply Chain with WIN SOURCE Solutions

-  Global Sourcing Solution
-  Obsolete Management
-  Cost Control Management
-  Shortage Management
-  Alternative Solution
-  Excess Inventory Management