



THE DATASHEET OF SPHCW1HDNC25YHQT2H



High Voltage LED Series Chip on Board

LC026B Gen.2



High efficacy COB LED package
well-suited for use in spotlight applications

Features & Benefits

- Chip on Board (COB) solution makes it easy to design in
- Simple assembly reduces manufacturing cost
- Low thermal resistance
- InGaN/GaN MQW LED with long time reliability
- Completed 6,000 hours of LM-80 Testing
- ENEC certified: Integral LED Module

Applications

- Spotlight / Downlight
- LED Retrofit Bulbs
- Outdoor Illumination



Table of Contents

1.	Characteristics	-----	3
2.	Product Code Information	-----	6
3.	Typical Characteristics Graphs	-----	13
4.	Outline Drawing & Dimension	-----	18
5.	Reliability Test Items & Conditions	-----	19
6.	Label Structure	-----	20
7.	Packing Structure	-----	22
8.	Precautions in Handling & Use	-----	25

1. Characteristics

a) Absolute Maximum Rating

Item	Symbol	Rating	Unit	Condition
Ambient / Operating Temperature	T_a	-40 ~ +105	°C	-
Storage Temperature	T_{stg}	-40 ~ +120	°C	-
LED Junction Temperature	T_j	150	°C	-
Case Temperature	T_c	105	°C	*Note
Forward Current	I_F	1300	mA	-
Power Dissipation	P_D	48.1	W	-
ESD (HBM)	-	±2	kV	-
ESD (MM)	-	±0.5	kV	-

b) Electro-optical Characteristics ($I_F = 720 \text{ mA}$, $T_a = 25 \text{ °C}$)

Item	Unit	Rank	Min.	Typ.	Max.
Forward Voltage (V_F)	V	YH	32.5	35.5	38.5
Color Rendering Index (R_a)	-	3	70	-	-
		5	80	-	-
		7	90	-	-
		8	95	-	-
		Thermal Resistance (junction to chip point)	°C/W	-	-
Beam Angle	°	-	-	115	-
Nominal Power	W	-	-	25.6	-
Eye Protection	-	Risk 1	-	-	-

Notes:

- 1) The COB is tested in pulsed condition at rated test current (10 ms pulse width) and rated temperature ($T_j = T_c = T_a = 25 \text{ °C}$)
- 2) Samsung maintains measurement tolerance of: forward voltage = ±5 %, CRI = ±1
- 3) Max $T_c=105$ °C is for ENEC condition. Refer to the derating curve, '3. Typical Characteristics Graph' designed within the range.

c) Luminous Flux Characteristics ($I_F = 720 \text{ mA}$)

CRI (R _a) Min.	Nominal CCT (K)	Flux Rank	Flux Bin	Sorting ¹⁾ @ T _c = 25 °C (lm)		Calculated Flux ²⁾ @ T _c = 85 °C (lm)	
				Min.	Max.	Min.	Max.
70	3000	3F	31	3266	3711	2939	3340
			32	3711	4157	3340	3741
	4000	3F	31	3429	3897	3086	3507
			32	3897	4365	3507	3928
	5000	3F	31	3462	3934	3116	3541
			32	3934	4406	3541	3965
80	2700	2G	32	3550	3760	3231	3422
			33	3760	3970	3422	3613
		2H	33	3760	3970	3422	3613
	3000	2G	31	3550	3770	3231	3431
			32	3770	3990	3431	3631
		2H	32	3770	3990	3431	3631
	3500	2G	31	3660	3880	3331	3531
			32	3880	4100	3531	3731
		2H	32	3880	4100	3531	3731
	4000	2G	31	3770	4000	3431	3640
			32	4000	4230	3640	3849
		2H	32	4000	4230	3640	3849
	5000	2G	35	3820	4050	3476	3686
			36	4050	4280	3686	3895
		2H	36	4050	4280	3686	3895
	5700	2G	35	3820	4050	3476	3686
			36	4050	4280	3686	3895
		2H	36	4050	4280	3686	3895

c) Luminous Flux Characteristics (I_F = 720 mA)

CRI (R _a) Min.	Nominal CCT (K)	Flux Rank	Flux Bin	Sorting ¹⁾ @ T _c = 25 °C (lm)		Calculated Flux ²⁾ @ T _c = 85 °C (lm)	
				Min.	Max.	Min.	Max.
90	2700	2G	24	2815	3050	2562	2776
			25	3050	3380	2776	3076
	3000	2G	24	2870	3110	2612	2830
			25	3110	3440	2830	3130
	3500	2G	24	2955	3200	2689	2912
			25	3200	3530	2912	3212
4000	2G	24	3035	3285	2762	2989	
		25	3285	3615	2989	3290	
95	2700	2F	21	2321	2578	2112	2346
			22	2578	2836	2346	2581
	3000	2F	21	2392	2658	2177	2419
			22	2658	2924	2419	2661
	3500	2F	21	2440	2711	2221	2467
			22	2711	2983	2467	2714

Notes:

- 1) The COB is tested in pulsed condition at rated test current (10 ms pulse width) and rated temperature (T_j = T_c = T_a = 25 °C)
- 2) Calculated flux values are for reference only
- 3) Samsung maintains measurement tolerance of: luminous flux = ±7 %, CRI = ±1

2. Product Code Information

1	2	3	4	5	6	7	8	9	10	11	12	13	14	15	16	17	18
S	P	H	C	W	1	H	D	N	C	2	5	Y	H	R	T	3	F

Digit	PKG Information	Code	Specification
1 2 3	Samsung Package High Power	SPH	
4 5	Color	WW CW	Warm White (T/U/V/W Ranks) Cool White (Q/R Ranks)
6	Product Version	1	
7 8	Form Factor	HD	COB
9	Lens Type	N	No lens
10	Internal Code	C	LC026
11	Chip Type	2	
12	CRI & Sorting Temperature	3 5 7 8	Min. 70 Min. 80 25 °C Min. 90 Min 95
13 14	Forward Voltage (V)	YH	32.5~38.5
15	CCT (K)	W V U T R Q	2700 K WA, WB (MacAdam Ellipse) 3000 K VA, VB (MacAdam Ellipse) VW, VX, VY, VZ (ANSI bin) 3500 K UA, UB (MacAdam Ellipse) 4000 K TA, TB (MacAdam Ellipse) TW, TX, TY, TZ (ANSI bin) 5000 K RA (MacAdam Ellipse) RW, RX, RY, RZ (ANSI bin) 5700 K QW, QX, QY, QZ (ANSI bin)
16	MacAdam / ANSI	2 3 T	MacAdam 2-step MacAdam 3-step ANSI bin
17 18	Luminous Flux	2F 2G 2H 3F	21, 22 (95 CRI) Bin Code: 31, 32, 33, 35, 36 (80 CRI); 24, 25 (90 CRI) 32, 33, 36 (80 CRI) 31, 32 (70 CRI)

a) Binning Structure ($I_F = 720 \text{ mA}$, $T_c = 25 \text{ }^\circ\text{C}$)

CRI (R_a) Min.	Nominal CCT (K)	Product Code	V_F Rank	Color Rank	Chrom. Bin	Flux Rank	Flux Bin	Flux Range (Φ_v , lm)
70	3000	SPHWW1HDNC23YHVT3F	YH	VT	VW, VX VY, VZ	3F	31	3266 ~ 3711
							32	3711 ~ 4157
	4000	SPHWW1HDNC23YHTT3F	YH	TT	TW, TX TY, TZ	3F	31	3429 ~ 3897
							32	3897 ~ 4365
	5000	SPHCW1HDNC23YHRT3F	YH	RT	RW, RX RY, RZ	3F	31	3462 ~ 3934
							32	3934 ~ 4406
80	2700	SPHWW1HDNC25YHW22G	YH	W2	WB	2G	32	3550 ~ 3760
							33	3760 ~ 3970
		SPHWW1HDNC25YHW32G	YH	W3	WA, WB	2G	32	3550 ~ 3760
							33	3760 ~ 3970
	SPHWW1HDNC25YHW22H	YH	W2	WB	2H	33	3760 ~ 3970	
						33	3760 ~ 3970	
	SPHWW1HDNC25YHW32H	YH	W3	WA, WB	2H	33	3760 ~ 3970	
						33	3760 ~ 3970	
	3000	SPHWW1HDNC25YHV22G	YH	V2	VB	2G	31	3550 ~ 3770
							32	3770 ~ 3990
		SPHWW1HDNC25YHV32G	YH	V3	VA, VB	2G	31	3550 ~ 3770
							32	3770 ~ 3990
		SPHWW1HDNC25YHV22H	YH	V2	VB	2H	32	3770 ~ 3990
							32	3770 ~ 3990
	SPHWW1HDNC25YHV32H	YH	V3	VA, VB	2H	32	3770 ~ 3990	
						32	3770 ~ 3990	
	3500	SPHWW1HDNC25YHU22G	YH	U2	UB	2G	31	3660 ~ 3880
							32	3880 ~ 4100
		SPHWW1HDNC25YHU32G	YH	U3	UA, UB	2G	31	3660 ~ 3880
							32	3880 ~ 4100
		SPHWW1HDNC25YHU22H	YH	U2	UB	2H	32	3880 ~ 4100
							32	3880 ~ 4100
	SPHWW1HDNC25YHU32H	YH	U3	UA, UB	2H	32	3880 ~ 4100	
						32	3880 ~ 4100	
4000	SPHWW1HDNC25YHT22G	YH	T2	TB	2G	31	3770 ~ 4000	
						32	4000 ~ 4230	
	SPHWW1HDNC25YHT32G	YH	T3	TA, TB	2G	31	3770 ~ 4000	
						32	4000 ~ 4230	
	SPHWW1HDNC25YHT22H	YH	T2	TB	2H	32	4000 ~ 4230	
						32	4000 ~ 4230	
SPHWW1HDNC25YHT32H	YH	T3	TA, TB	2H	32	4000 ~ 4230		
					32	4000 ~ 4230		
5000	SPHCW1HDNC25YHR32G	YH	R3	RA	2G	35	3820 ~ 4050	
						36	4050 ~ 4280	
	SPHCW1HDNC25YHRT2G	YH	RT	RW, RX, RY, RZ	2G	35	3820 ~ 4050	
						36	4050 ~ 4280	
	SPHCW1HDNC25YHR32H	YH	R3	RA	2H	36	4050 ~ 4280	
						36	4050 ~ 4280	
SPHCW1HDNC25YHRT2H	YH	RT	RW, RX, RY, RZ	2H	36	4050 ~ 4280		
					36	4050 ~ 4280		
5700	SPHCW1HDNC25YHQT2G	YH	QT	QW, QX QY, QZ	2G	35	3820 ~ 4050	
						36	4050 ~ 4280	
SPHCW1HDNC25YHQT2H	YH	QT	QW, QX QY, QZ	2H	36	4050 ~ 4280		

a) Binning Structure ($I_F = 720 \text{ mA}$, $T_c = 25 \text{ }^\circ\text{C}$)

CRI (R _a) Min.	Nominal CCT (K)	Product Code	V _F Rank	Color Rank	Chrom. Bin	Flux Rank	Flux Bin	Flux Range (Φ _v , lm)
90	2700	SPHWW1HDNC27YHW22G	YH	W2	WB	2G	24	2815 ~ 3050
							25	3050 ~ 3380
		SPHWW1HDNC27YHW32G	YH	W3	WA, WB	2G	24	2815 ~ 3050
							25	3050 ~ 3380
	3000	SPHWW1HDNC27YHV22G	YH	V2	VB	2G	24	2870 ~ 3110
							25	3110 ~ 3440
		SPHWW1HDNC27YHV32G	YH	V3	VA, VB	2G	24	2870 ~ 3110
							25	3110 ~ 3440
	3500	SPHWW1HDNC27YHU22G	YH	U2	UB	2G	24	2955 ~ 3200
							25	3200 ~ 3530
		SPHWW1HDNC27YHU32G	YH	U3	UA, UB	2G	24	2955 ~ 3200
							25	3200 ~ 3530
	4000	SPHWW1HDNC27YHT22G	YH	T2	TB	2G	24	3035 ~ 3285
							25	3285 ~ 3615
		SPHWW1HDNC27YHT32G	YH	T3	TA, TB	2G	24	3035 ~ 3285
							25	3285 ~ 3615
95	2700	SPHWW1HDNC28YHW22F	YH	W2	WB	2F	21	2321 ~ 2578
							22	2578 ~ 2836
		SPHWW1HDNC28YHW32F	YH	W3	WA, WB	2F	21	2321 ~ 2578
							22	2578 ~ 2836
	3000	SPHWW1HDNC28YHV22F	YH	V2	VB	2F	21	2392 ~ 2658
							22	2658 ~ 2924
		SPHWW1HDNC28YHV32F	YH	V3	VA, VB	2F	21	2392 ~ 2658
							22	2658 ~ 2924
	3500	SPHWW1HDNC28YHU22F	YH	U2	UB	2F	21	2440 ~ 2711
							22	2711 ~ 2983
		SPHWW1HDNC28YHU32F	YH	U3	UA, UB	2F	21	2440 ~ 2711
							22	2711 ~ 2983

b) Chromaticity Region & Coordinates ($I_f = 720 \text{ mA}$, $T_a = 25 \text{ }^\circ\text{C}$)

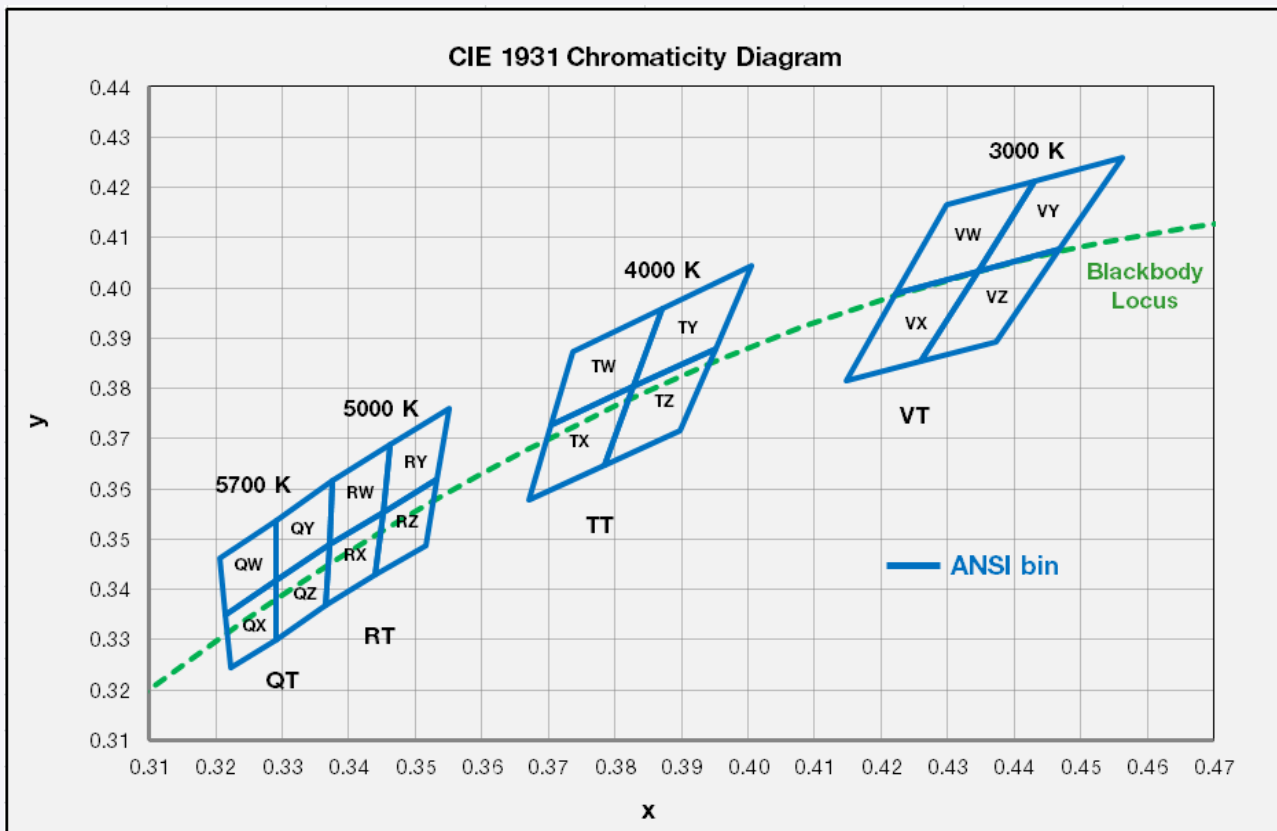

Region	CIE x	CIE y	Region	CIE x	CIE y
V rank (3000 K)					
VW	0.4223	0.399	VY	0.4345	0.4033
	0.4345	0.4033		0.4468	0.4077
	0.4431	0.4213		0.4562	0.4260
	0.4299	0.4165		0.4431	0.4213
VX	0.4223	0.399	VZ	0.4260	0.3854
	0.4147	0.3814		0.4373	0.3893
	0.4260	0.3854		0.4468	0.4077
	0.4345	0.4033		0.4345	0.4033
R rank (5000 K)					
RW	0.3376	0.3616	RY	0.3463	0.3687
	0.3463	0.3687		0.3551	0.3760
	0.3451	0.3554		0.3533	0.3620
	0.3371	0.3490		0.3451	0.3554
RX	0.3371	0.3490	RZ	0.3451	0.3554
	0.3451	0.3554		0.3533	0.3620
	0.3440	0.3428		0.3515	0.3487
	0.3366	0.3369		0.3440	0.3428

Region	CIE x	CIE y	Region	CIE x	CIE y
T rank (4000 K)					
TW	0.3736	0.3874	TY	0.3871	0.3959
	0.3871	0.3959		0.4006	0.4044
	0.3828	0.3803		0.3952	0.388
	0.3703	0.3726		0.3828	0.3803
TX	0.3703	0.3726	TZ	0.3828	0.3803
	0.3828	0.3803		0.3952	0.388
	0.3784	0.3647		0.3898	0.3716
	0.367	0.3578		0.3784	0.3647
Q rank (5700 K)					
QW	0.3207	0.3462	QY	0.3290	0.3538
	0.3290	0.3538		0.3376	0.3616
	0.3290	0.3417		0.3371	0.3490
	0.3215	0.3350		0.3290	0.3417
QX	0.3215	0.3350	QZ	0.3290	0.3417
	0.3290	0.3417		0.3371	0.3490
	0.3290	0.3300		0.3366	0.3369
	0.3222	0.3243		0.3290	0.3300

b) Chromaticity Region & Coordinates ($I_F = 720 \text{ mA}$, $T_a = 25 \text{ }^\circ\text{C}$)



MacAdam Ellipse (WA, WB)					
Step	CIE x	CIE y	θ	a	b
2-step	0.4578	0.4101	53.70	0.0054	0.0028
3-step	0.4578	0.4101	53.70	0.0081	0.0042

MacAdam Ellipse (VA, VB)					
Step	CIE x	CIE y	θ	a	b
2-step	0.4338	0.403	53.22	0.0056	0.0027
3-step	0.4338	0.4030	53.22	0.0083	0.0041

MacAdam Ellipse (UA, UB)					
Step	CIE x	CIE y	θ	a	b
2-step	0.4073	0.3917	54.00	0.0062	0.0028
3-step	0.4073	0.3917	54.00	0.0093	0.0041

MacAdam Ellipse (TA, TB)					
Step	CIE x	CIE y	θ	a	b
2-step	0.3818	0.3797	53.72	0.0063	0.0027
3-step	0.3818	0.3797	53.72	0.0094	0.0040

MacAdam Ellipse (RA)					
Step	CIE x	CIE y	θ	a	b
3-step	0.3447	0.3553	59.62	0.0082	0.0035

Note:

Samsung maintains measurement tolerance of: $C_x, C_y = \pm 0.005$



3. Typical Characteristics Graphs

a) Spectrum Distribution ($I_F = 720 \text{ mA}$, $T_a = 25 \text{ }^\circ\text{C}$)

CCT: 2700 K (80 CRI)

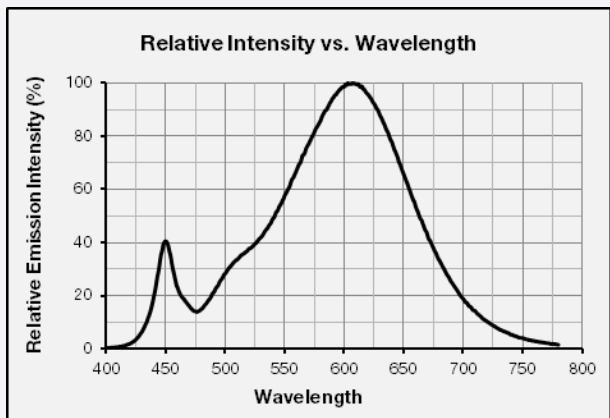

CCT: 3000 K (80 CRI)

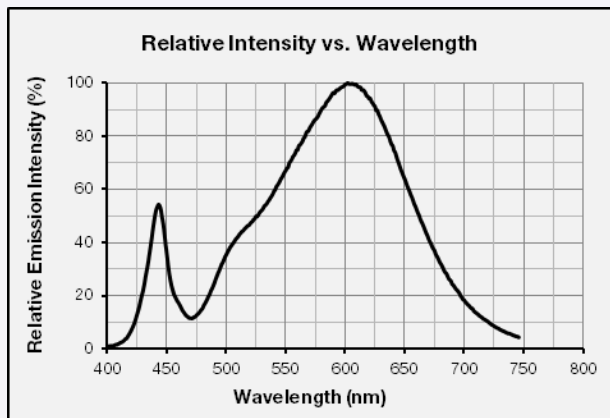

CCT: 3500 K (80 CRI)

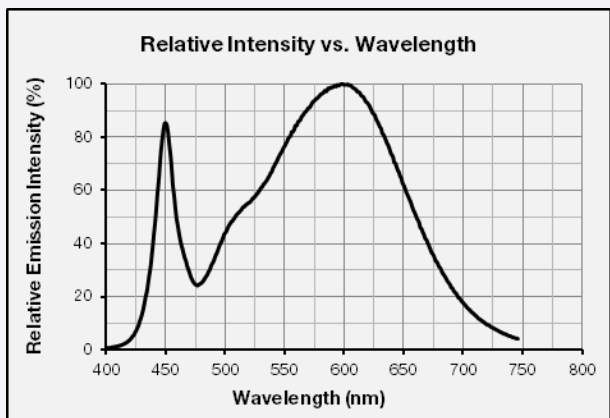

CCT: 4000 K (80 CRI)

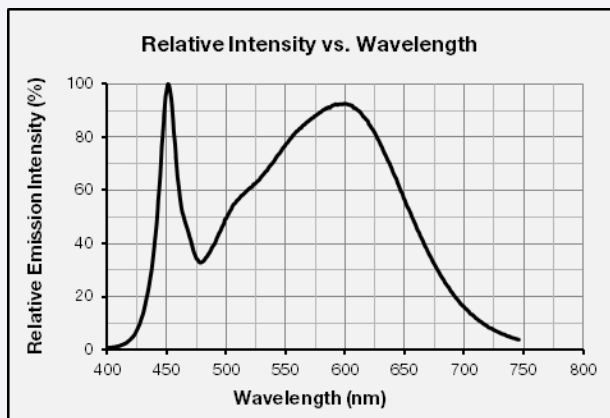

CCT: 5000 K (80 CRI)

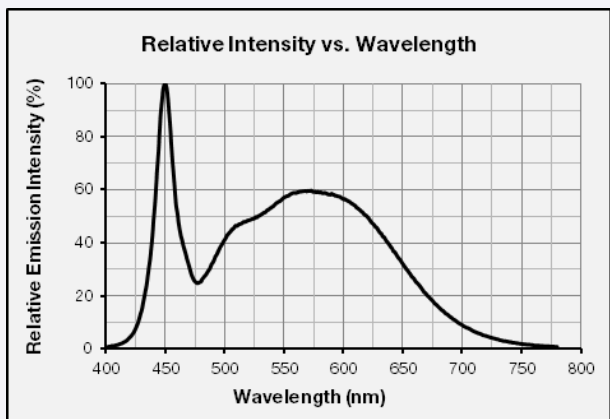

CCT: 5700 K (80 CRI)

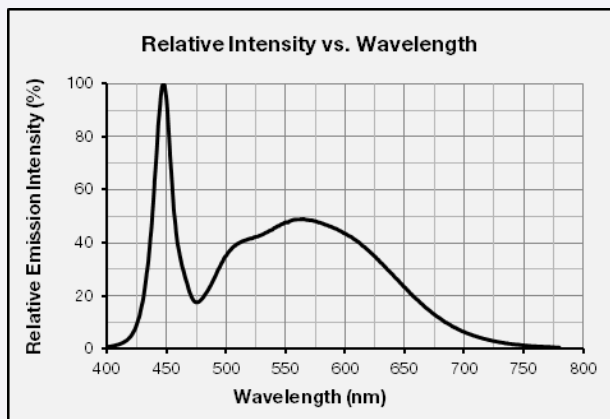

CCT: 2700 K (90 CRI)

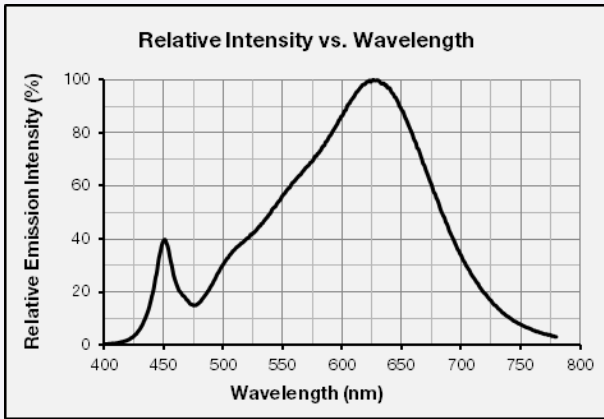

CCT: 3000 K (90 CRI)

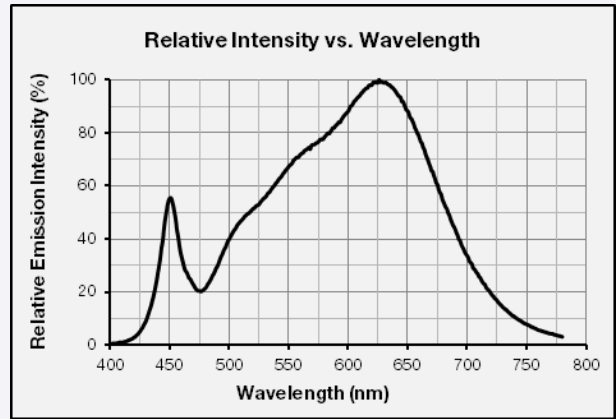

CCT: 3500 K (90 CRI)

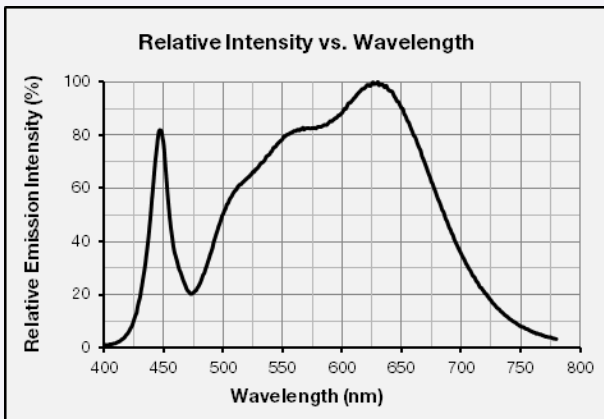

CCT: 4000 K (90 CRI)

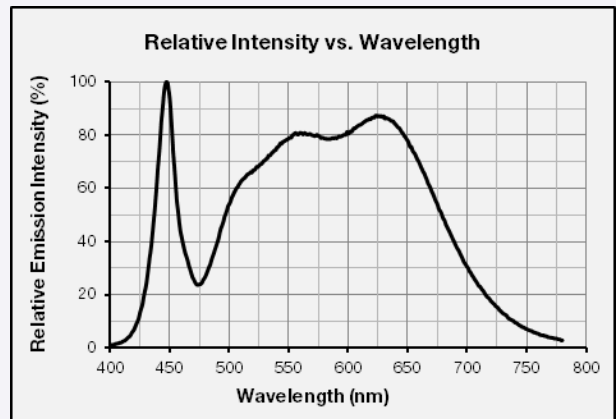

b) Forward Current Characteristics (T_a = 25 °C)

80 CRI

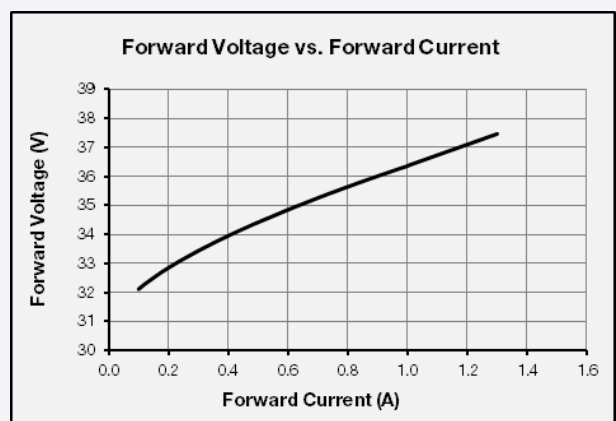
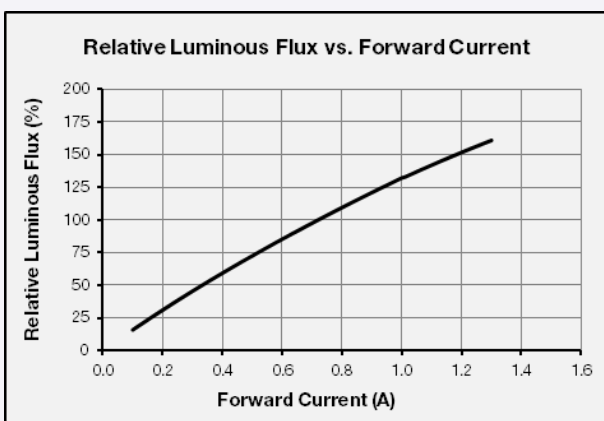

90 CRI

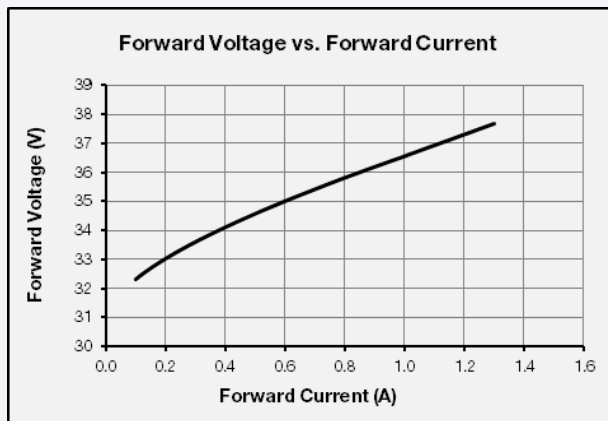
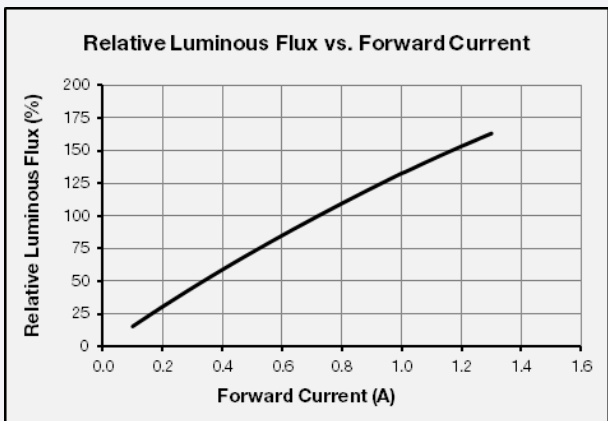

c) Temperature Characteristics (I_F = 720 mA)

80 CRI

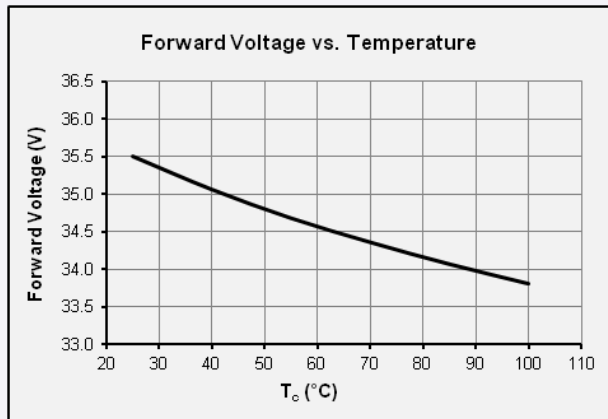

90 CRI

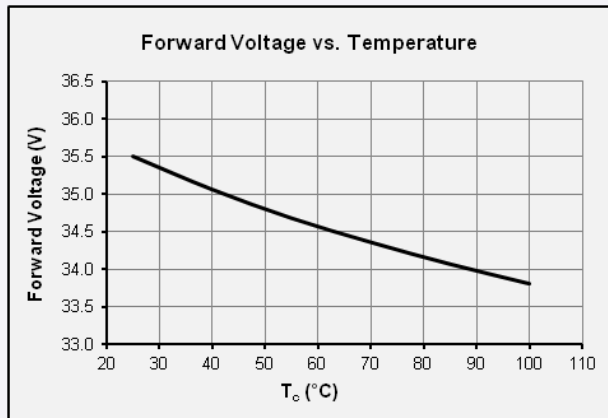
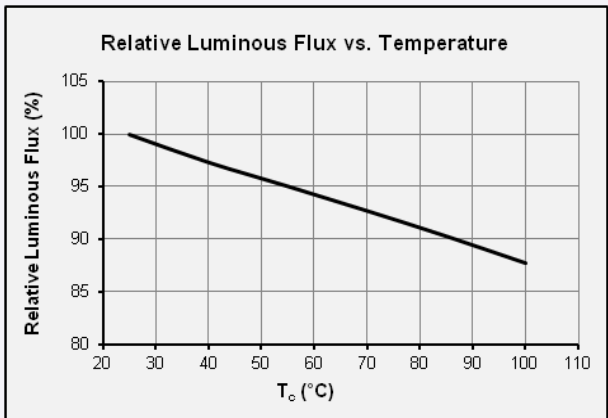

d) Color Shift Characteristics

$T_a = 25\text{ }^\circ\text{C}$

$I_f = 720\text{ mA}$

80 CRI

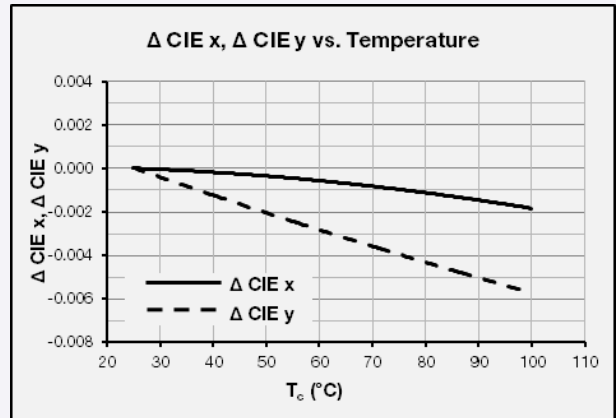

90 CRI

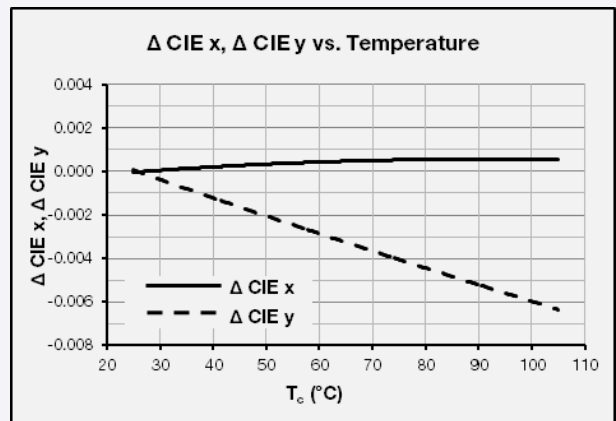

e) Derating Curve



f) Beam Angle Characteristics ($I_F = 720 \text{ mA}$, $T_a = 25 \text{ }^\circ\text{C}$)

80 CRI

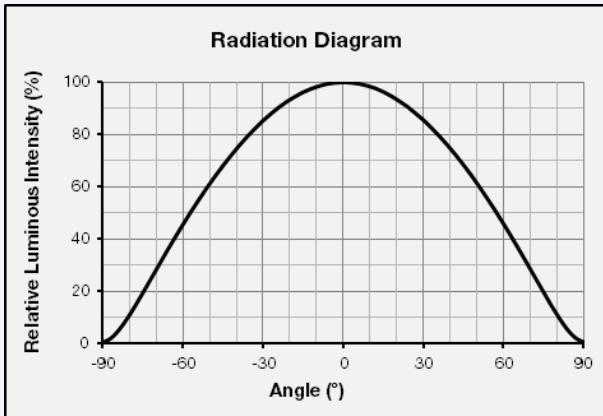

90 CRI

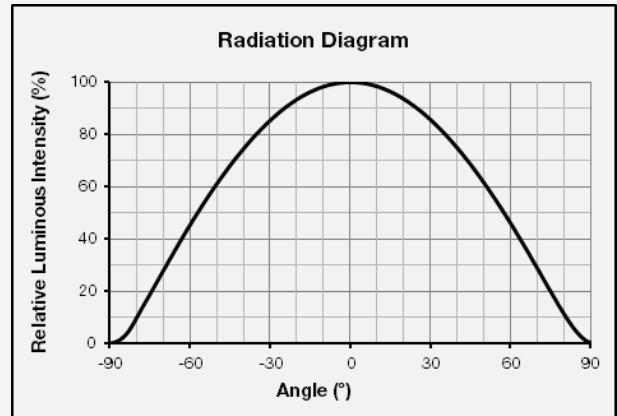

4. Outline Drawing & Dimension

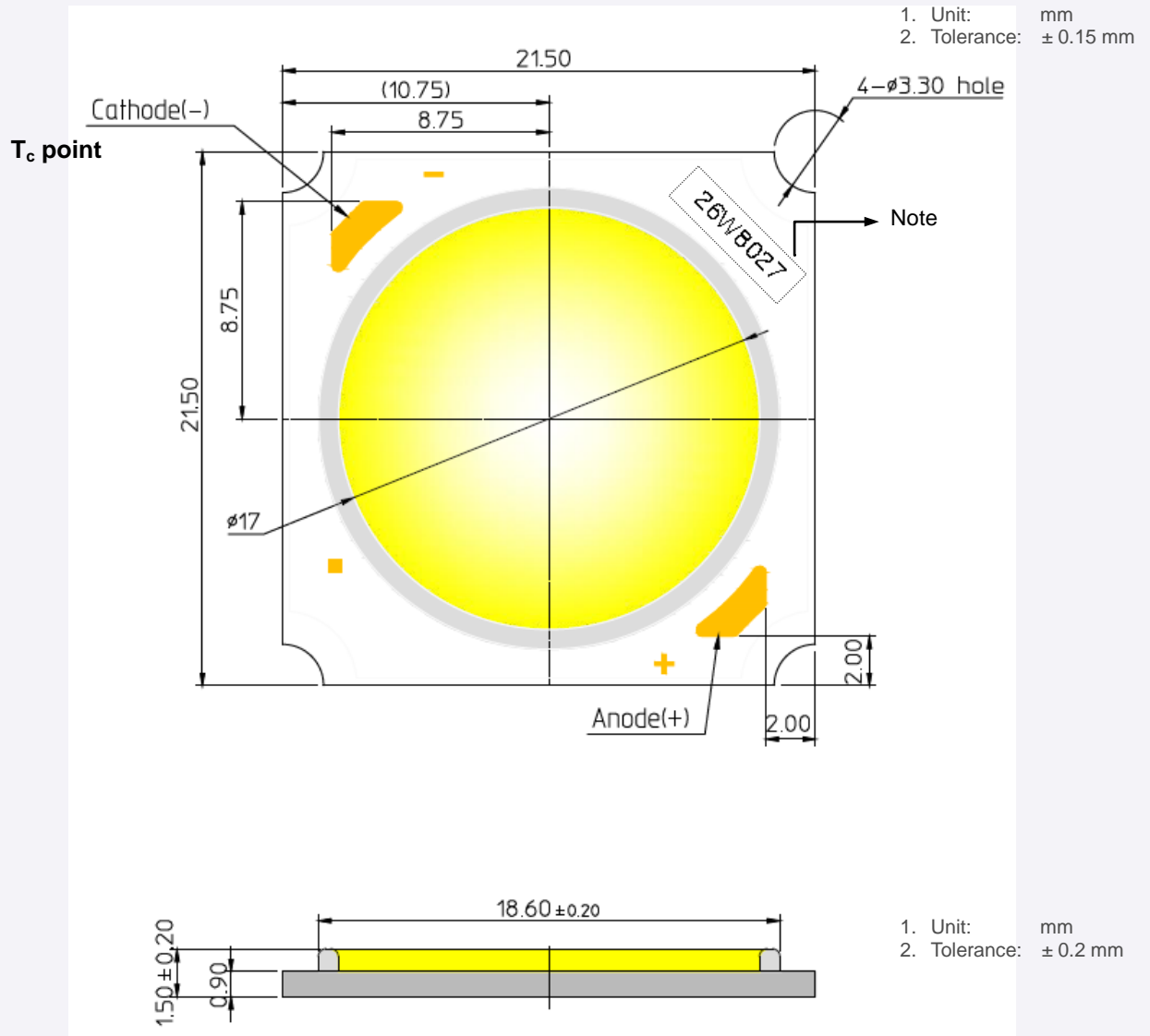

Item	Dimension	Tolerance	Unit
Length	21.50	±0.15	mm
Width	21.50	±0.15	mm
Height	1.50	±0.20	mm
Light Emitting Surface (LES) Diameter	17	±0.15	mm

Note: Denoted product information above is only an example
(26W8027 : 26W, CRI80+, 2700K)

5. Reliability Test Items & Conditions

a) Test Items

Test Item	Test Condition	Test Hour / Cycle
Room Temperature Life Test	25 °C, $I_F = \max$	1000 h
High Temperature Humidity Life Test	85 °C, 85 % RH, DC Derating, $I_F = \max$	1000 h
High Temperature Life Test	105 °C, DC Derating, $I_F = \max$	1000 h
Low Temperature Life Test	-40 °C, DC 1300 mA	1000 h
High Temperature Storage	120 °C	1000 h
Low Temperature Storage	-40 °C	1000 h
Thermal Shock	-45 °C / 15 min ↔ 125 °C / 15 min temperature change in 5 min	200 cycles
Temperature Cycle On/Off Test	-40 °C / 85 °C each 20 min, 100 min transfer power on/off each 5 min, DC 720 mA	100 cycles
Temperature Humidity Storage Test	-10 °C ↔ 25 °C, 95 % RH ↔ 85 °C, 95 % RH (24 h / cycle)	100 cycles
ESD (HBM)	R ₁ : 10 MΩ R ₂ : 1.5 kΩ C: 100 pF V: ±2 kV	5 times
ESD (MM)	R ₁ : 10 MΩ R ₂ : 0 kΩ C: 200 pF V: ±0.5 kV	5 times
Vibration Test	20 ~ 80 Hz (displacement: 0.06 inch, max. 20 g) 80 ~ 2 kHz (max. 20 g) min. frequency ↔ max. frequency 4 min transfer	4 times
Mechanical Shock Test	1500 g, 0.5 ms each of the 6 surfaces (3 axis x 2 sides)	5 times
Salt Spray Test	35 °C, 5 % salt water 8 h spray, 16 h dwell	2 cycles

b) Criteria for Judging the Damage

Item	Symbol	Test Condition ($T_c = 25\text{ °C}$)	Limit	
			Min.	Max.
Forward Voltage	V_F	$I_F = 720\text{ mA}$	L.S.L. * 0.9	U.S.L. * 1.1
Luminous Flux	Φ_v	$I_F = 720\text{ mA}$	L.S.L * 0.7	U.S.L * 1.3

6. Label Structure

a) Label Structure

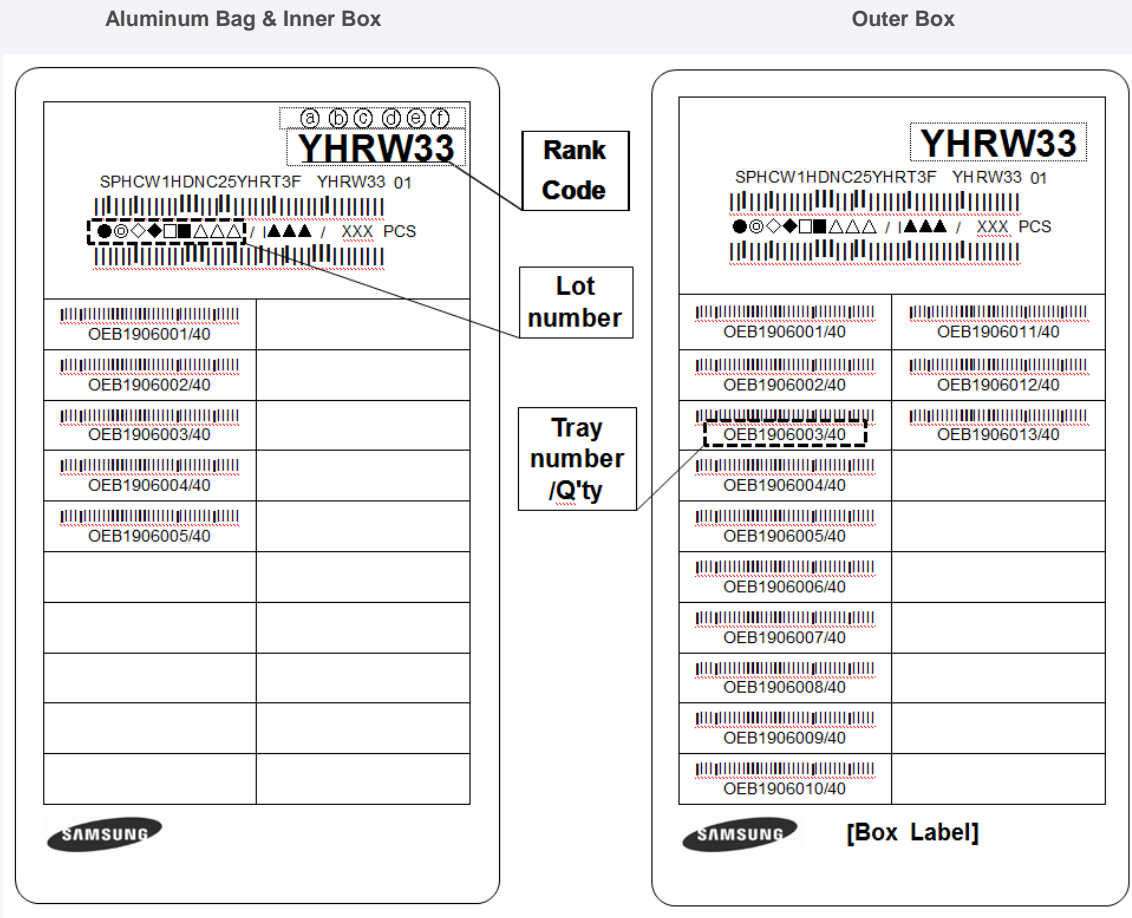

Note: Denoted rank code and product code above is only an example (see description on page 6)

Rank Code:

- ⒶⒷ: Forward Voltage rank (refer to page 7-10)
- ⒸⒹ: Chromaticity bin (refer to page 12-12)
- ⒺⒻ: Luminous Flux bin (refer to page 7-10)

b) Lot Number

The lot number is composed of the following characters:

●◎◇◆□■△△△ / 1▲▲▲ / xxx PCS

- : Production site (S: Giheung, Korea, G: Tianjin, China)
- ◎ : L (LED)
- ◇ : Product state (A: Normal, B: Bulk, C: First Production, R: Reproduction, S: Sample)
- ◆ : Year (Y: 2014, Z: 2015, A: 2016, ...)
- : Month (1~9, A, B, C)
- : Day (1~9, A, B~V)
- △△△ : Product serial number (001 ~ 009)
- ▲▲▲ : Tray number (001 ~ 999)

7. Packing Structure

Packing material	Max. quantity in pcs of COB	Dimension (mm)			
		Length	Width	Height	Tolerance
Tray	40	322.6	135.9	10.8	1.0
Aluminum Bag	320 (8 trays)	450	230	-	10
PE Foam Pad	-	280	130	10	2
Inner Box	320 (1 aluminum bag)	338	148	55	2
Outer Box	1,280 (4 inner boxes)	351	308	120	5
Pallet	71,680 (56 outer boxes)	1000	1000	130	10

a) Packing Structure



b) Tray

① COVER

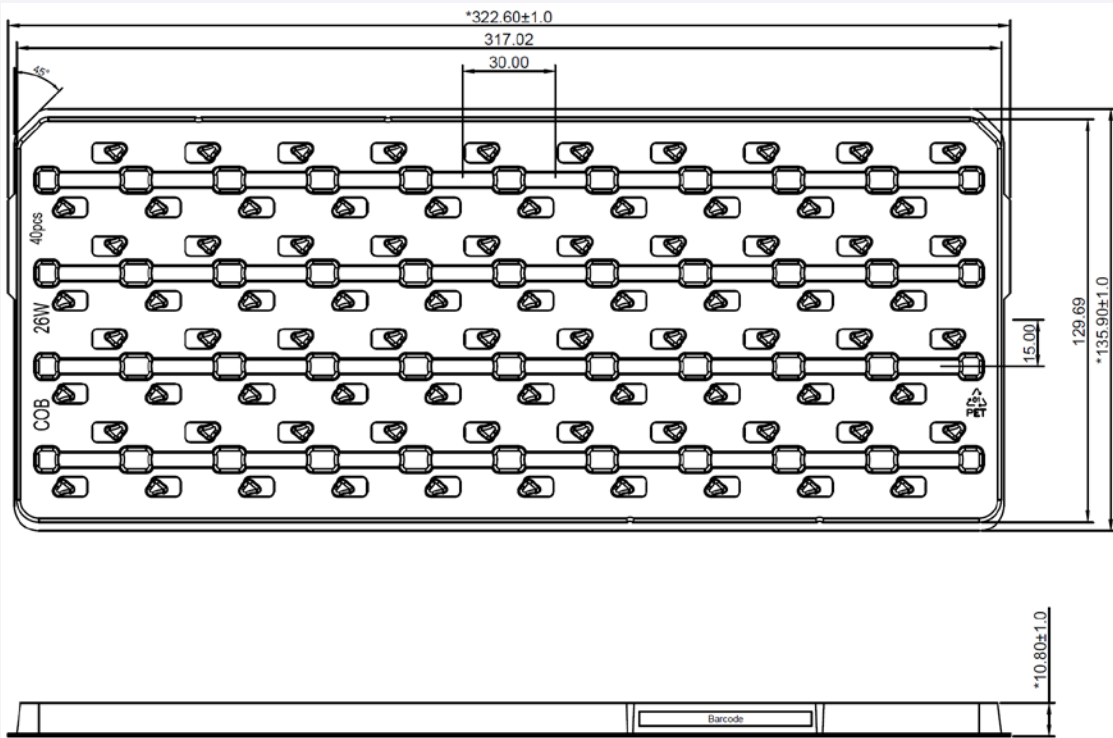

② BODY

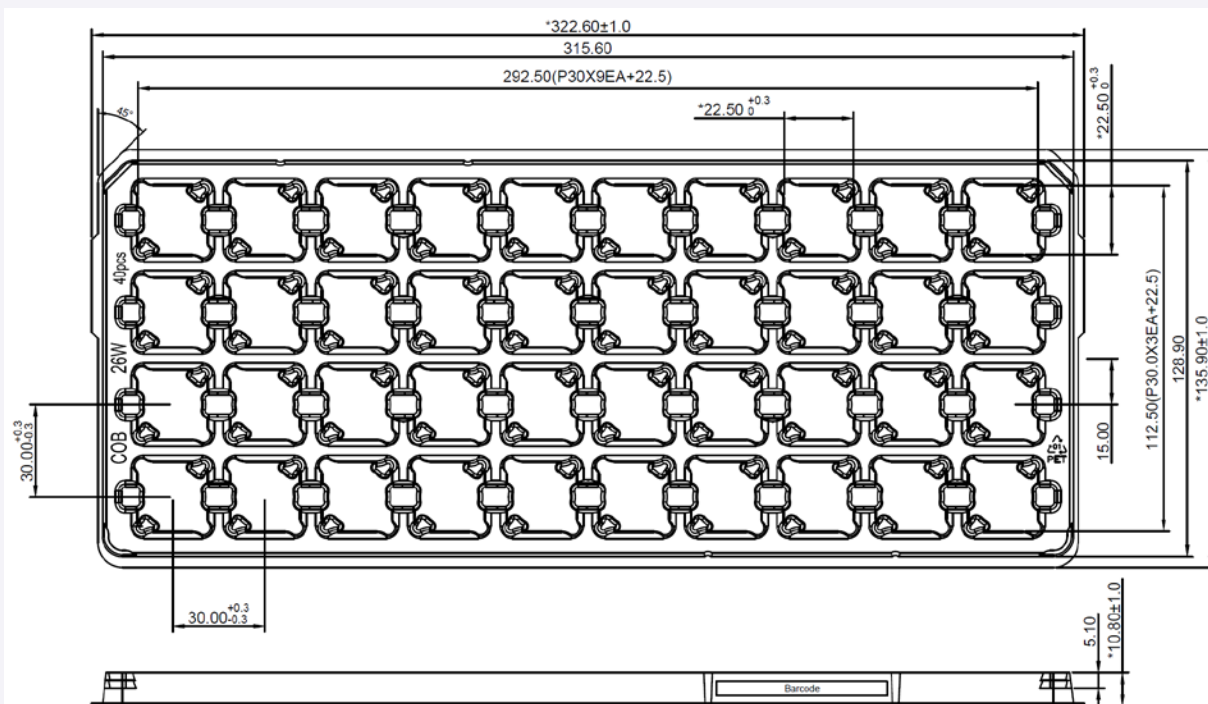

c) Aluminum Vinyl Packing Bag



d) Silica Gel & Humidity Indicator Card inside Aluminum Vinyl Packing Bag

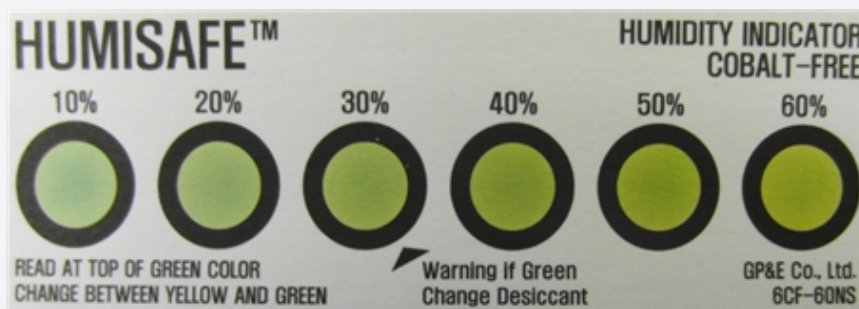

8. Precautions in Handling & Use

- 1) This device should not be used in any type of fluid such as water, oil, organic solvent, etc. When cleaning is required, IPA is recommended as the cleaning agent. Some solvent-based cleaning agent may damage the silicone resins used in the device.
- 2) LEDs must be stored in a clean environment. If the LEDs are to be stored for three months or more after being shipped from Samsung, they should be packed with a nitrogen-filled container (shelf life of sealed bags is 12 months at temperature 0~40 °C, 0~90 % RH).
- 3) After storage bag is opened, device subjected to soldering, solder reflow, or other high temperature processes must be:
 - a. Mounted within 672 hours (28 days) at an assembly line with a condition of no more than 30 °C / 60 % RH, or
 - b. Stored at <10 % RH
- 4) Repack unused products with anti-moisture packing, fold to close any opening and then store in a dry place.
- 5) Devices require baking before mounting, if humidity card reading is >60 % at 23 ± 5 °C.
- 6) Devices must be baked for 1 hour at 60 ± 5 °C, if baking is required.
- 7) The LEDs are sensitive to the static electricity and surge current. It is recommended to use a wrist band or anti-electrostatic glove when handling the LEDs. If voltage exceeding the absolute maximum rating is applied to LEDs, it may cause damage or even destruction to LED devices. Damaged LEDs may show some unusual characteristics such as increase in leakage current, lowered turn-on voltage, or abnormal lighting of LEDs at low current.
- 8) VOCs (Volatile Organic Compounds) can be generated from adhesives, flux, hardener or organic additives used in luminaires (fixtures). Transparent LED silicone encapsulant is permeable to those chemicals and they may lead to a discoloration of encapsulant when they exposed to heat or light. This phenomenon can cause a significant loss of light emitted (output) from the luminaires. In order to prevent these problems, we recommend users to know the physical properties of materials used in luminaires and they must be carefully selected.
- 9) The resin area is very sensitive, please do not handle, press, touch, rub, clean, or pick by with tweezers on it. Instead, please pick at the handling area as indicated below.



Legal and additional information.

[About Samsung Electronics Co., Ltd.](#)

Samsung Electronics Co., Ltd. inspires the world and shapes the future with transformative ideas and technologies, redefining the worlds of TVs, smartphones, wearable devices, tablets, cameras, digital appliances, printers, medical equipment, network systems and semiconductors.

We are also leading in the Internet of Things space through, among others, our Digital Health and Smart Home initiatives. We employ 307,000 people across 84 countries. To discover more, please visit our official website at www.samsung.com and our official blog at global.samsungtomorrow.com.

Copyright © 2015 Samsung Electronics Co., Ltd. All rights reserved.

Samsung is a registered trademark of Samsung Electronics Co., Ltd.

Specifications and designs are subject to change without notice. Non-metric weights and measurements are approximate. All data were deemed correct at time of creation. Samsung is not liable for errors or omissions. All brand, product, service names and logos are trademarks and/or registered trademarks of their respective owners and are hereby recognized and acknowledged.



Samsung Electronics Co., Ltd.
95, Samsung 2-ro
Giheung-gu
Yongin-si, Gyeonggi-do, 446-711
KOREA

www.samsungled.com



Looking for pricing, stock, or lifecycle information?

Click below to explore more details on WIN SOURCE:

-  [View SPHCW1HDNC25YHQT2H on WIN SOURCE](#)
-  [Samsung Information](#)

Optimize Your Supply Chain with WIN SOURCE Solutions

-  Global Sourcing Solution
-  Obsolete Management
-  Cost Control Management
-  Shortage Management
-  Alternative Solution
-  Excess Inventory Management