



**THE DATASHEET OF
SPHWW1HDND25YHU33G**



High Voltage LED Series Chip on Board

LC033B Gen.2



High efficacy COB LED package,
well-suited for use in spotlight applications

Features & Benefits

- Chip on Board (COB) solution makes it easy to design in
- Simple assembly reduces manufacturing cost
- Low thermal resistance
- InGaN/GaN MQW LED with long time reliability
- Completed 6,000 hours of LM-80 Testing
- ENEC certified: Integral LED Module

Applications

- Spotlight / Downlight
- LED Retrofit Bulbs
- Outdoor Illumination



Table of Contents

1.	Characteristics	-----	3
2.	Product Code Information	-----	6
3.	Typical Characteristics Graphs	-----	12
4.	Outline Drawing & Dimension	-----	15
5.	Reliability Test Items & Conditions	-----	16
6.	Label Structure	-----	17
7.	Packing Structure	-----	19
8.	Precautions in Handling & Use	-----	22

1. Characteristics

a) Absolute Maximum Rating

Item	Symbol	Rating	Unit	Condition
Ambient / Operating Temperature	T_a	-40 ~ +105	°C	-
Storage Temperature	T_{stg}	-40 ~ +120	°C	-
LED Junction Temperature	T_j	150	°C	-
Case Temperature	T_c	105	°C	*Note
Forward Current	I_F	1620	mA	-
Power Dissipation	P_D	59.9	W	-
ESD (HBM)	-	±2	kV	-
ESD (MM)	-	±0.5	kV	-

b) Electro-optical Characteristics ($I_F = 900 \text{ mA}$, $T_c = 25 \text{ °C}$)

Item	Unit	Rank	Min.	Typ.	Max.
Forward Voltage (V_F)	V	YH	32.5	35.5	38.5
Color Rendering Index (R_a)	-	3	70	-	-
		5	80 ($R_9 > 0$)	-	-
		7	90	-	-
Thermal Resistance (junction to chip point)	°C/W		-	0.9	-
Beam Angle	°		-	115	-
Nominal Power	W			32.0	
Eye Protection	°	Risk 1	-		-

Notes:

- 1) The COB is tested in pulsed condition at rated test current (10 ms pulse width) and rated temperature ($T_j = T_c = T_a = 25 \text{ °C}$)
- 2) Samsung maintains measurement tolerance of: forward voltage = $\pm 5 \%$, CRI = ± 1
- 3) Max $T_c=105$ is for ENEC condition. Refer to the derating curve, '3. Typical Characteristics Graph' designed within the range.

c) Luminous Flux Characteristics (I_F = 900 mA)

CRI (R _a) Min.	Nominal CCT (K)	Flux Rank	Flux Bin	Sorting ¹⁾ @ T _c = 25 °C (lm)		Calculated Flux ²⁾ @ T _c = 85 °C (lm)		
				Min.	Max.	Min.	Max.	
70	3000	4P	41	4021	4570	3619	4113	
			42	4570	5118	4113	4606	
	4000	4P	41	4222	4798	3800	4318	
			42	4798	5374	4318	4836	
	5000	4P	41	4262	4844	3836	4359	
			42	4844	5425	4359	4882	
80	2700	3G	41	4210	4485	3831	4081	
			42	4485	4761	4081	4332	
		3H	42	4485	4761	4081	4332	
	3000	3G	41	4478	4771	4075	4342	
			42	4771	5064	4342	4609	
		3H	42	4771	5064	4342	4609	
	3500	3G	41	4613	4915	4198	4472	
			42	4915	5216	4472	4747	
		3H	42	4915	5216	4472	4747	
	4000	3G	40	4437	4747	4037	4320	
			41	4747	5058	4320	4603	
		3H	41	4747	5058	4320	4603	
			40	4478	4792	4075	4361	
		5000	3G	41	4792	5105	4361	4646
				41	4792	5105	4361	4646
	5700	3G	40	4478	4792	4075	4361	
			41	4792	5105	4361	4646	
		3H	41	4792	5105	4361	4646	
	90	2700	3Q	33	3527	3810	3210	3467
				34	3810	4200	3467	3822
		3000	3Q	33	3599	3887	3276	3538
				34	3887	4277	3538	3892
		3500	3Q	33	3707	4004	3374	3644
				34	4004	4394	3644	3999
4000		3Q	33	3815	4121	3472	3750	
			34	4121	4511	3750	4105	
95		2700	3J	31	2857	3175	2600	2889
				32	3175	3492	2889	3178
		3000	3J	31	2946	3273	2681	2978
				32	3273	3600	2978	3276
	3500	3J	31	3034	3371	2761	3068	
			32	3371	3708	3068	3375	

Notes:

- 1) The COB is tested in pulsed condition at rated test current (10 ms pulse width) and rated temperature (T_j = T_c = T_a = 25 °C)
- 2) Calculated flux values are for reference only
- 3) Samsung maintains measurement tolerance of: luminous flux = ±7 %, CRI = ±1

2. Product Code Information

1	2	3	4	5	6	7	8	9	10	11	12	13	14	15	16	17	18
S	P	H	C	W	1	H	D	N	D	2	5	Y	H	R	T	3	P

Digit	PKG Information	Code	Specification
1 2 3	Samsung Package High Power	SPH	
4 5	Color	WW CW	Warm White (T/U/V/W Ranks) Cool White (Q/R Ranks)
6	Product Version	1	
7 8	Form Factor	HD	COB
9	Lens Type	N	No lens
10	Internal Code	D	LC033
11	Chip Type	2	
12	CRI & Sorting Temperature	3 5 7 8	Min. 70 Min. 80 Min. 90 Min 95 25 °C
13 14	Forward Voltage (V)	YH	32.5~38.5
15	CCT (K)	W V U T R Q	2700 K 3000 K 3500 K 4000 K 5000 K 5700 K WA, WB (MacAdam Ellipse) VA, VB (MacAdam Ellipse) UA, UB (MacAdam Ellipse) TA, TB (MacAdam Ellipse) RA (MacAdam Ellipse) Bin Code: VW, VX, VY, VZ (ANSI bin) TW, TX, TY, TZ (ANSI bin) RW, RX, RY, RZ (ANSI bin) QW, QX, QY, QZ (ANSI bin)
16	MacAdam / ANSI	2 3 T	MacAdam 2-step MacAdam 3-step ANSI bin
17 18	Luminous Flux	3J 3G 3H 3Q 4P	31, 32 (95 CRI) 40, 41, 42 (80 CRI) 41, 42 (80 CRI) 33, 34 (90 CRI) 41, 42 (70 CRI) Bin Code:

a) Binning Structure ($I_F = 900 \text{ mA}$, $T_c = 25 \text{ }^\circ\text{C}$)

CRI (R_a) Min.	Nominal CCT (K)	Product Code	V_F Rank	Color Rank	Chrom. Bin	Flux Rank	Flux Bin	Flux Range (Φ_v , lm)
70	3000	SPHWW1HDND23YHVT4P	YH	VT	VW, VX VY, VZ	4P	41	4021 ~ 4570
							42	4570 ~ 5118
	4000	SPHWW1HDND23YHTT4P	YH	TT	TW, TX TY, TZ	4P	41	4222 ~ 4798
							42	4798 ~ 5374
	5000	SPHCW1HDND23YHRT4P	YH	RT	RW, RX RY, RZ	4P	41	4262 ~ 4844
							42	4844 ~ 5425
80	2700	SPHWW1HDND25YHW23G	YH	W2	WB	3G	41	4210 ~ 4485
							42	4485 ~ 4761
		SPHWW1HDND25YHW33G	YH	W3	WA, WB	3G	41	4210 ~ 4485
							42	4485 ~ 4761
	SPHWW1HDND25YHW23H	YH	W2	WB	3H	42	4485 ~ 4761	
						42	4485 ~ 4761	
	SPHWW1HDND25YHW33H	YH	W3	WA, WB	3H	42	4485 ~ 4761	
						41	4478 ~ 4771	
	3000	SPHWW1HDND25YHV23G	YH	V2	VB	3G	42	4771 ~ 5064
							41	4478 ~ 4771
		SPHWW1HDND25YHV33G	YH	V3	VA, VB	3G	42	4771 ~ 5064
							41	4478 ~ 4771
	SPHWW1HDND25YHV23H	YH	V2	VB	3H	42	4771 ~ 5064	
						42	4771 ~ 5064	
	SPHWW1HDND25YHV33H	YH	V3	VA, VB	3H	42	4771 ~ 5064	
						41	4613 ~ 4915	
	3500	SPHWW1HDND25YHU23G	YH	U2	UB	3G	42	4915 ~ 5216
							41	4613 ~ 4915
		SPHWW1HDND25YHU33G	YH	U3	UA, UB	3G	42	4915 ~ 5216
							41	4613 ~ 4915
	SPHWW1HDND25YHU23H	YH	U2	UB	3H	42	4915 ~ 5216	
						42	4915 ~ 5216	
	SPHWW1HDND25YHU33H	YH	U3	UA, UB	3H	42	4915 ~ 5216	
						40	4437 ~ 4747	
4000	SPHWW1HDND25YHT23G	YH	T2	TB	3G	41	4747 ~ 5058	
						40	4437 ~ 4747	
	SPHWW1HDND25YHT33G	YH	T3	TA, TB	3G	41	4747 ~ 5058	
						40	4437 ~ 4747	
	SPHWW1HDND25YHT23H	YH	T2	TB	3H	41	4747 ~ 5058	
						41	4747 ~ 5058	
SPHWW1HDND25YHT33H	YH	T3	TA, TB	3H	41	4747 ~ 5058		
					40	4478 ~ 4792		
5000	SPHCW1HDND25YHR33G	YH	R3	RA	3G	41	4792 ~ 5105	
						40	4478 ~ 4792	
	SPHCW1HDND25YHRT3G	YH	RT	RW, RX, RY, RZ	3G	41	4792 ~ 5105	
						40	4478 ~ 4792	
	SPHCW1HDND25YHR33H	YH	R3	RA	3H	41	4792 ~ 5105	
						41	4792 ~ 5105	
SPHCW1HDND25YHRT3H	YH	RT	RW, RX, RY, RZ	3H	41	4792 ~ 5105		
					40	4478 ~ 4792		
5700	SPHCW1HDND25YHQT3G	YH	QT	QW, QX QY, QZ	3G	41	4792 ~ 5105	
						40	4478 ~ 4792	
SPHCW1HDND25YHQT3H	YH	QT	QW, QX QY, QZ	3H	41	4792 ~ 5105		

a) Binning Structure ($I_F = 900 \text{ mA}$, $T_c = 25 \text{ }^\circ\text{C}$)

CRI (R _a) Min.	Nominal CCT (K)	Product Code	V _F Rank	Color Rank	Chrom. Bin	Flux Rank	Flux Bin	Flux Range (Φ _v , lm)
90	2700	SPHWW1HDND27YHW23Q	YH	W2	WB	3Q	33	3527 ~ 3810
							34	3810 ~ 4200
		SPHWW1HDND27YHW33Q	YH	W3	WA, WB	3Q	33	3527 ~ 3810
							34	3810 ~ 4200
	3000	SPHWW1HDND27YHV23Q	YH	V2	VB	3Q	33	3599 ~ 3887
							34	3887 ~ 4277
		SPHWW1HDND27YHV33Q	YH	V3	VA, VB	3Q	33	3599 ~ 3887
							34	3887 ~ 4277
	3500	SPHWW1HDND27YHU23Q	YH	U2	UB	3Q	33	3707 ~ 4004
							34	4004 ~ 4394
		SPHWW1HDND27YHU33Q	YH	U3	UA, UB	3Q	33	3707 ~ 4004
							34	4004 ~ 4394
4000	SPHWW1HDND27YHT23Q	YH	T2	TB	3Q	33	3815 ~ 4121	
						34	4121 ~ 4511	
	SPHWW1HDND27YHT33Q	YH	T3	TA, TB	3Q	33	3815 ~ 4121	
						34	4121 ~ 4511	
95	2700	SPHWW1HDND28YHW23J	YH	W2	WB	3J	31	2857 ~ 3175
							32	3175 ~ 3492
		SPHWW1HDND28YHW33J	YH	W3	WA, WB	3J	31	2857 ~ 3175
							32	3175 ~ 3492
	3000	SPHWW1HDND28YHV23J	YH	V2	VB	3J	31	2946 ~ 3273
							32	3273 ~ 3600
		SPHWW1HDND28YHV33J	YH	V3	VA, VB	3J	31	2946 ~ 3273
							32	3273 ~ 3600
	3500	SPHWW1HDND28YHU23J	YH	U2	UB	3J	31	3034 ~ 3371
							32	3371 ~ 3708
		SPHWW1HDND28YHU33J	YH	U3	UA, UB	3J	31	3034 ~ 3371
							32	3371 ~ 3708

b) Chromaticity Region & Coordinates ($I_F = 900 \text{ mA}$, $T_a = 25 \text{ }^\circ\text{C}$)

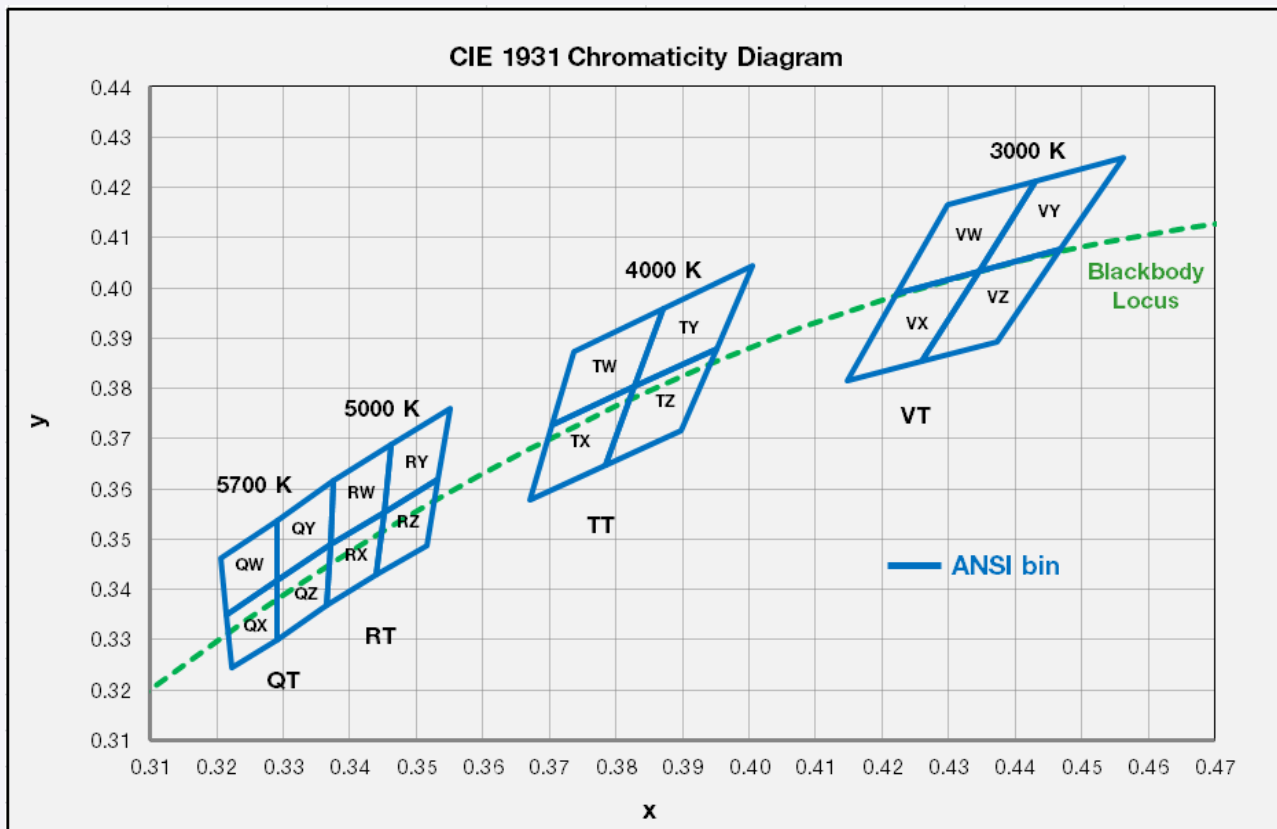

Region	CIE x	CIE y	Region	CIE x	CIE y
V rank (3000 K)					
VW	0.4223	0.3990	VY	0.4345	0.4033
	0.4345	0.4033		0.4468	0.4077
	0.4431	0.4213		0.4562	0.4260
	0.4299	0.4165		0.4431	0.4213
VX	0.4223	0.3990	VZ	0.4260	0.3854
	0.4147	0.3814		0.4373	0.3893
	0.4260	0.3854		0.4468	0.4077
	0.4345	0.4033		0.4345	0.4033
R rank (5000 K)					
RW	0.3376	0.3616	RY	0.3463	0.3687
	0.3463	0.3687		0.3551	0.3760
	0.3451	0.3554		0.3533	0.3620
	0.3371	0.3490		0.3451	0.3554
RX	0.3371	0.3490	RZ	0.3451	0.3554
	0.3451	0.3554		0.3533	0.3620
	0.3440	0.3428		0.3515	0.3487
	0.3366	0.3369		0.3440	0.3428

Region	CIE x	CIE y	Region	CIE x	CIE y
T rank (4000 K)					
TW	0.3736	0.3874	TY	0.3871	0.3959
	0.3871	0.3959		0.4006	0.4044
	0.3828	0.3803		0.3952	0.3880
	0.3703	0.3726		0.3828	0.3803
TX	0.3703	0.3726	TZ	0.3828	0.3803
	0.3828	0.3803		0.3952	0.3880
	0.3784	0.3647		0.3898	0.3716
	0.3670	0.3578		0.3784	0.3647
Q rank (5000 K)					
QW	0.3207	0.3462	QY	0.3290	0.3538
	0.3290	0.3538		0.3376	0.3616
	0.3290	0.3417		0.3371	0.3490
	0.3215	0.3350		0.3290	0.3417
QX	0.3215	0.3350	QZ	0.3290	0.3417
	0.3290	0.3417		0.3371	0.3490
	0.3290	0.3300		0.3366	0.3369
	0.3222	0.3243		0.3290	0.3300

b) Chromaticity Region & Coordinates ($I_F = 900 \text{ mA}$, $T_a = 25 \text{ }^\circ\text{C}$)

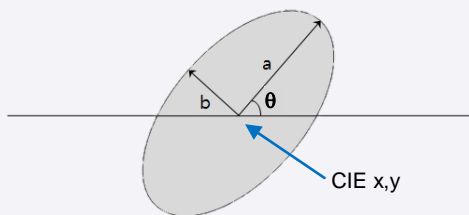
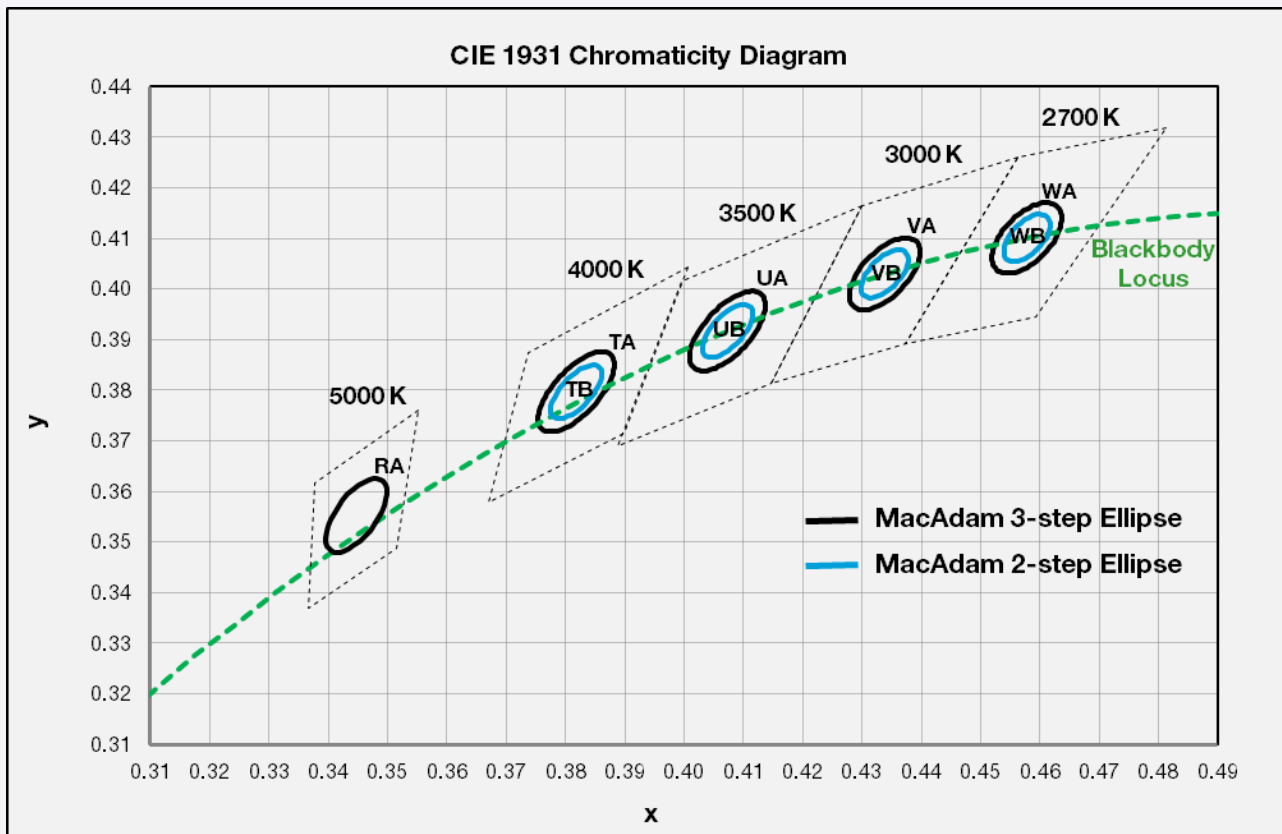

MacAdam Ellipse (WA, WB)					
Step	CIE x	CIE y	θ	a	b
2-step	0.4578	0.4101	53.70	0.0054	0.0028
3-step	0.4578	0.4101	53.70	0.0081	0.0042

MacAdam Ellipse (VA, VB)					
Step	CIE x	CIE y	θ	a	b
2-step	0.4338	0.4030	53.22	0.0056	0.0027
3-step	0.4338	0.4030	53.22	0.0083	0.0041

MacAdam Ellipse (UA, UB)					
Step	CIE x	CIE y	θ	a	b
2-step	0.4073	0.3917	54.00	0.0062	0.0028
3-step	0.4073	0.3917	54.00	0.0093	0.0041

MacAdam Ellipse (TA, TB)					
Step	CIE x	CIE y	θ	a	b
2-step	0.3818	0.3797	53.72	0.0063	0.0027
3-step	0.3818	0.3797	53.72	0.0094	0.0040

MacAdam Ellipse (RA)					
Step	CIE x	CIE y	θ	a	b
3-step	0.3447	0.3553	59.62	0.0082	0.0035

Note:

Samsung maintains measurement tolerance of: $C_x, C_y = \pm 0.005$

3. Typical Characteristics Graphs

a) Spectrum Distribution ($I_F = 900 \text{ mA}$, $T_c = 25 \text{ }^\circ\text{C}$)

CCT: 2700 K

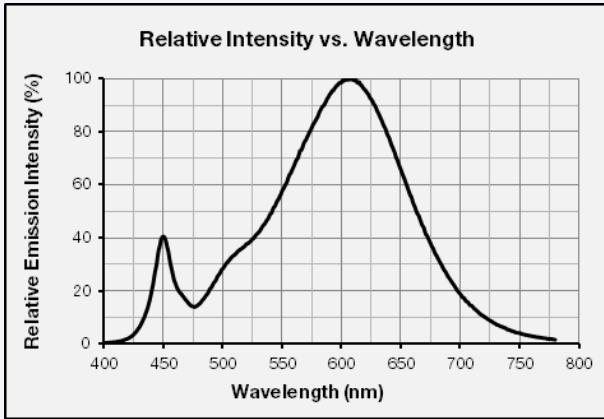

CCT: 3000 K

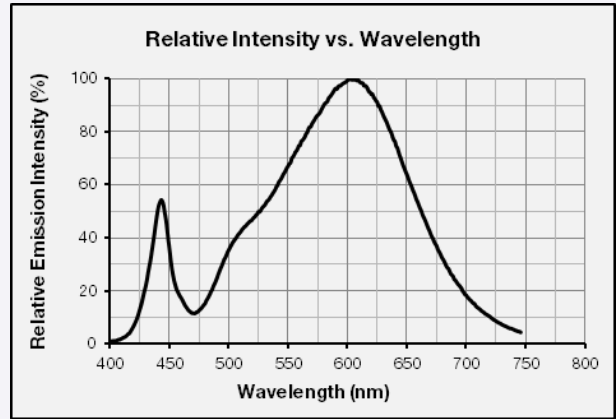

CCT: 3500 K

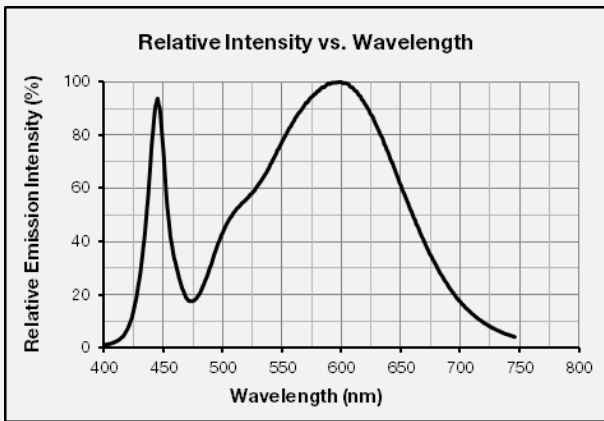

CCT: 4000 K

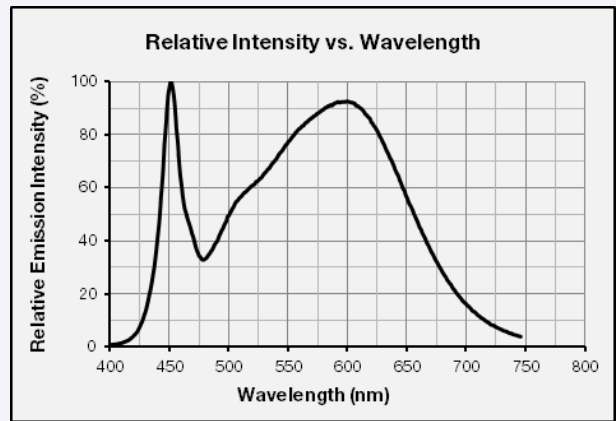

CCT: 5000 K

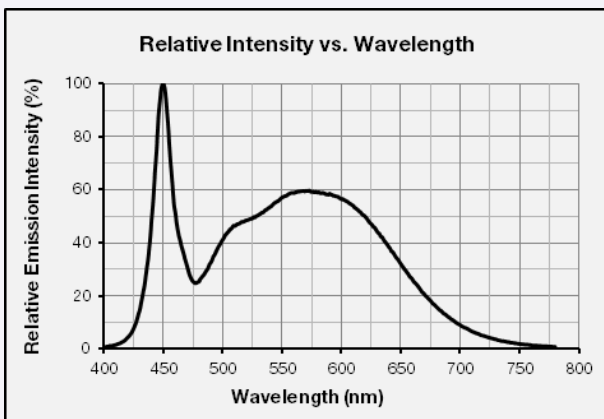

CCT: 5700 K

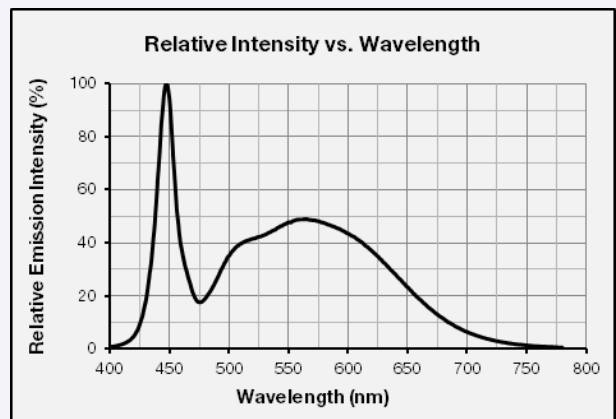

b) Forward Current Characteristics ($T_c = 25\text{ }^\circ\text{C}$)

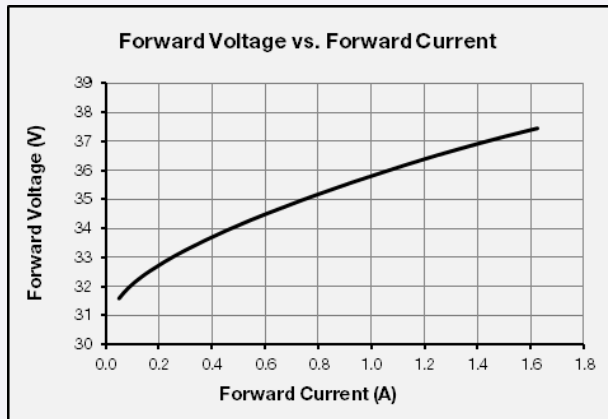
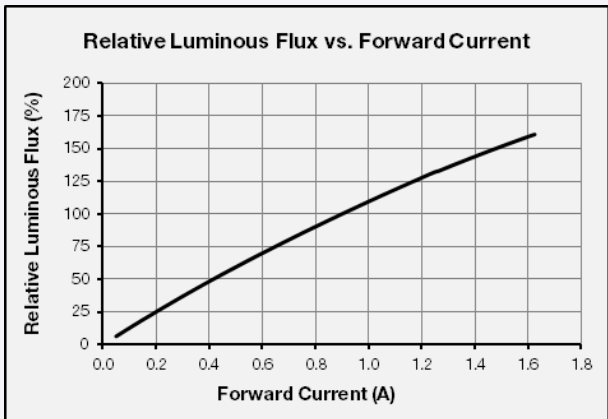

c) Temperature Characteristics ($I_F = 900\text{ mA}$)

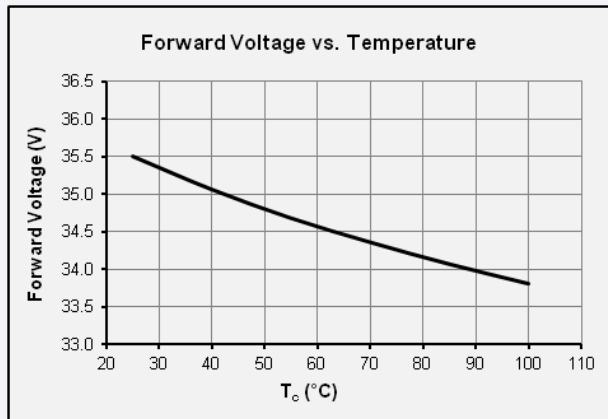
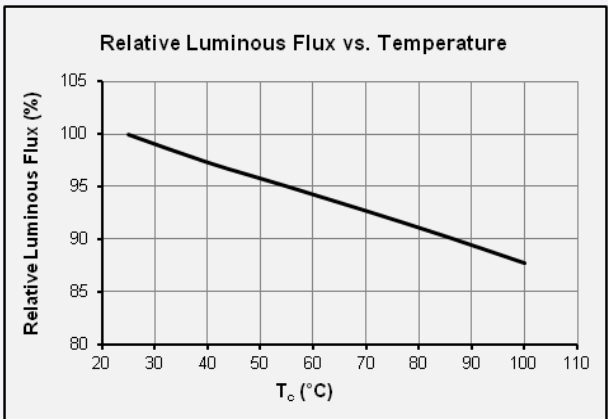

d) Color Shift Characteristics $T_c = 25\text{ }^\circ\text{C}$

$I_F = 900\text{ mA}$

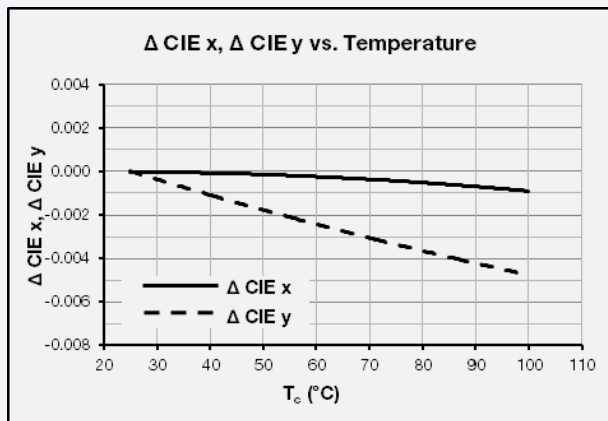
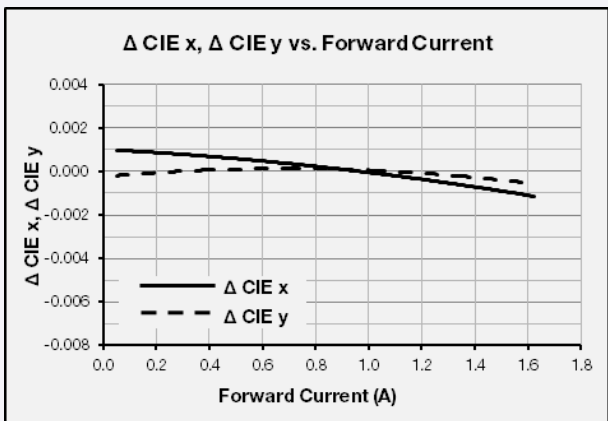

e) Derating Curve

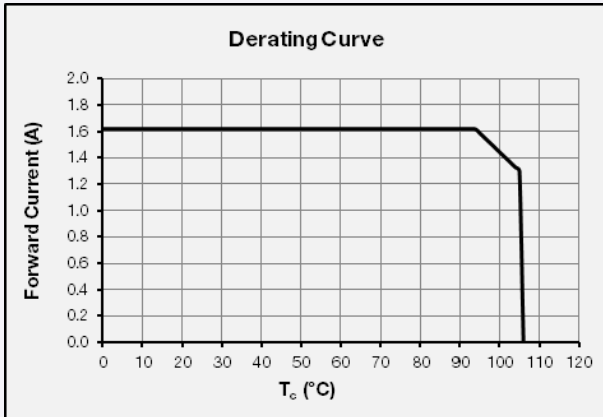
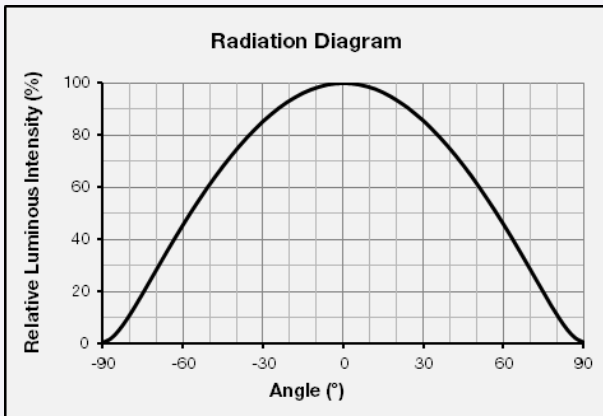
f) Beam Angle Characteristics ($I_F = 900 \text{ mA}$, $T_c = 25 \text{ }^{\circ}\text{C}$)

4. Outline Drawing & Dimension

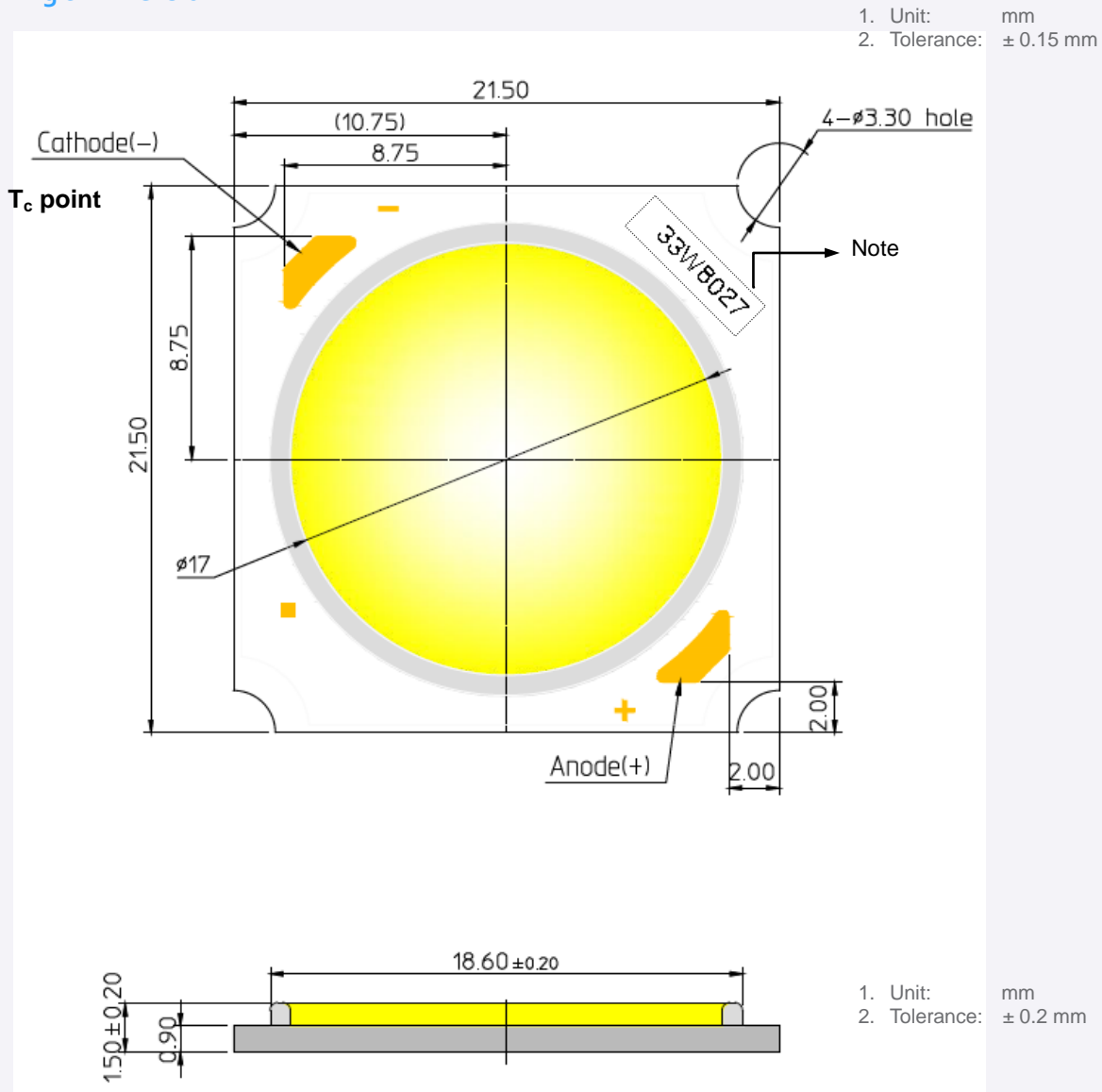

Item	Dimension	Tolerance	Unit
Length	21.50	± 0.15	mm
Width	21.50	± 0.15	mm
Height	1.50	± 0.20	mm
Light Emitting Surface (LES) Diameter	17	± 0.15	mm

Note: Denoted product information above is only an example
 (33W8027 : 33W, CRI80+, 2700K)



5. Reliability Test Items & Conditions

a) Test Items

Test Item	Test Condition	Test Hour / Cycle
Room Temperature Life Test	25 °C, $I_F = \text{max}$	1000 h
High Temperature Humidity Life Test	85 °C, 85 % RH, DC Derating, $I_F = \text{max}$	1000 h
High Temperature Life Test	105 °C, DC Derating, $I_F = \text{max}$	1000 h
Low Temperature Life Test	-40 °C, DC 1620 mA	1000 h
High Temperature Storage	120 °C	1000 h
Low Temperature Storage	-40 °C	1000 h
Thermal Shock	-45 °C / 15 min ↔ 125 °C / 15 min temperature change in 5 min	200 cycles
Temperature Cycle On/Off Test	-40 °C / 85 °C each 20 min, 100 min transfer power on/off each 5 min, DC 900 mA	100 cycles
Temperature Humidity Storage Test	-10 °C ↔ 25 °C, 95 % RH ↔ 85 °C, 95 % RH (24 h / cycle)	100 cycles
ESD (HBM)	R ₁ : 10 MΩ R ₂ : 1.5 kΩ C: 100 pF V: ±2 kV	5 times
ESD (MM)	R ₁ : 10 MΩ R ₂ : 0 kΩ C: 200 pF V: ±0.5 kV	5 times
Vibration Test	20 ~ 80 Hz (displacement: 0.06 inch, max. 20 g) 80 ~ 2 kHz (max. 20 g) min. frequency ↔ max. frequency 4 min transfer	4 times
Mechanical Shock Test	1500 g, 0.5 ms each of the 6 surfaces (3 axis x 2 sides)	5 times
Salt Spray Test	35 °C, 5 % salt water 8 h spray, 16 h dwell	2 cycles

b) Criteria for Judging the Damage

Item	Symbol	Test Condition ($T_c = 25\text{ °C}$)	Limit	
			Min.	Max.
Forward Voltage	V_F	$I_F = 900\text{ mA}$	L.S.L. * 0.9	U.S.L. * 1.1
Luminous Flux	Φ_v	$I_F = 900\text{ mA}$	L.S.L * 0.7	U.S.L * 1.3

6. Label Structure

a) Label Structure

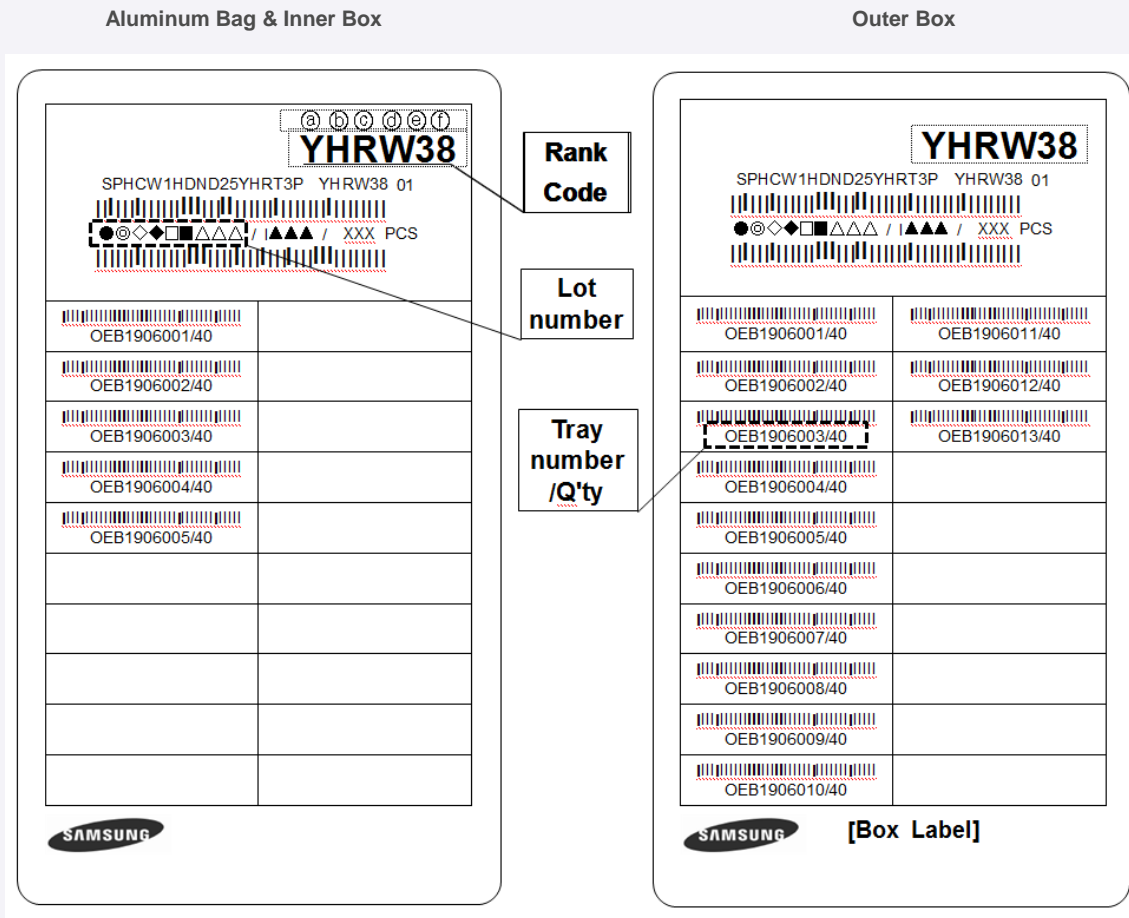

Note: Denoted rank code and product code above is only an example (see description on page 5)

Rank Code:

- ⒶⒷ: Forward Voltage rank (refer to page 7-10)
- ⒸⒹ: Chromaticity bin (refer to page 11-12)
- ⒺⒻ: Luminous Flux bin (refer to page 7-10)

b) Lot Number

The lot number is composed of the following characters:

●◎◇◆□■△△△ / 1▲▲▲ / xxx PCS

- : Production site (S: Giheung, Korea, G: Tianjin, China)
- ◎ : L (LED)
- ◇ : Product state (A: Normal, B: Bulk, C: First Production, R: Reproduction, S: Sample)
- ◆ : Year (Y: 2014, Z: 2015, A: 2016, ...)
- : Month (1~9, A, B, C)
- : Day (1~9, A, B~V)
- △△△ : Product serial number (001 ~ 009)
- ▲▲▲ : Tray number (001 ~ 999)

7. Packing Structure

Packing material	Max. quantity in pcs of COB	Dimension (mm)			
		Length	Width	Height	Tolerance
Tray	40	322.6	135.9	10.8	1.0
Aluminum Bag	320 (8 trays)	450	230	-	10
PE Foam Pad	-	280	130	10	2
Inner Box	320 (1 aluminum bag)	338	148	55	2
Outer Box	1,280 (4 inner boxes)	351	308	120	5
Pallet	71,680 (56 outer boxes)	1000	1000	130	10

a) Packing Structure

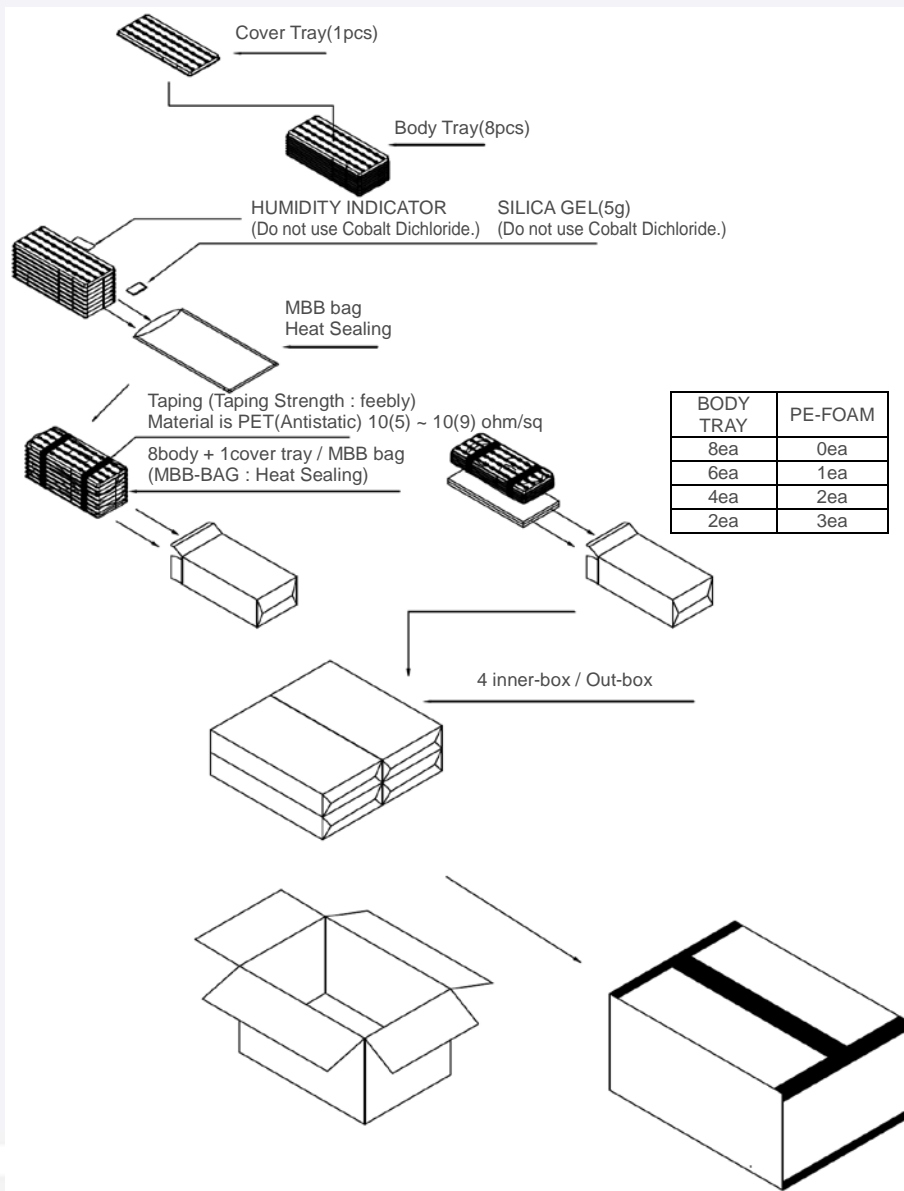

b) Tray

① COVER

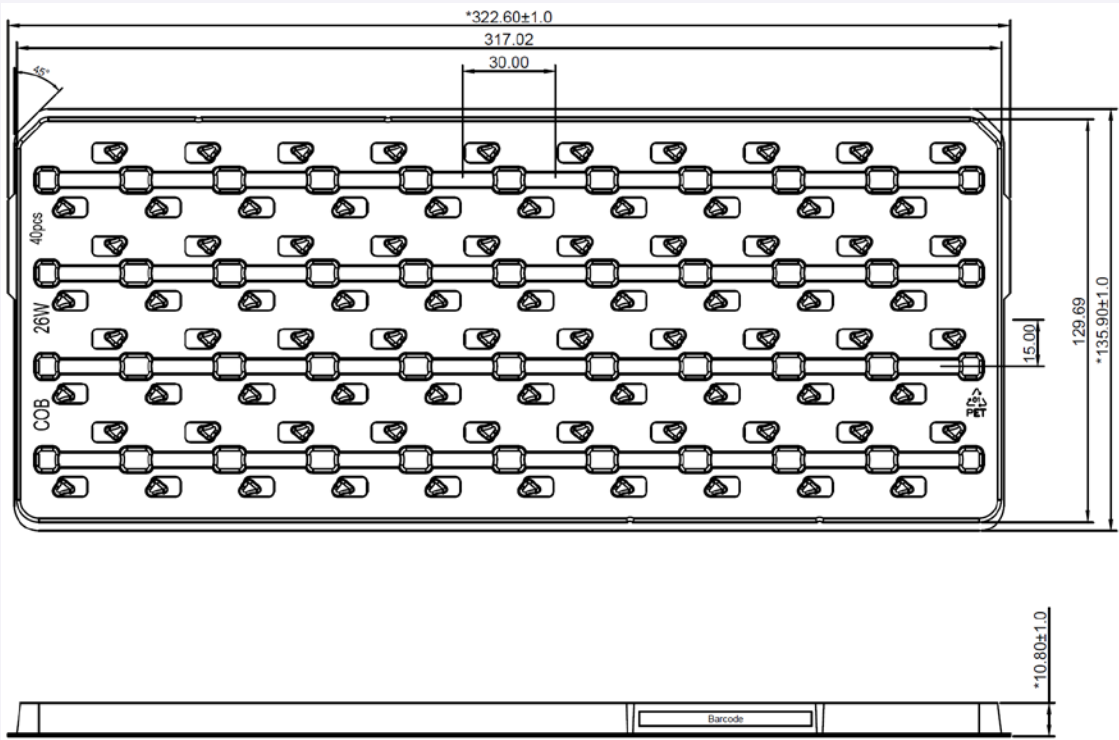

② BODY

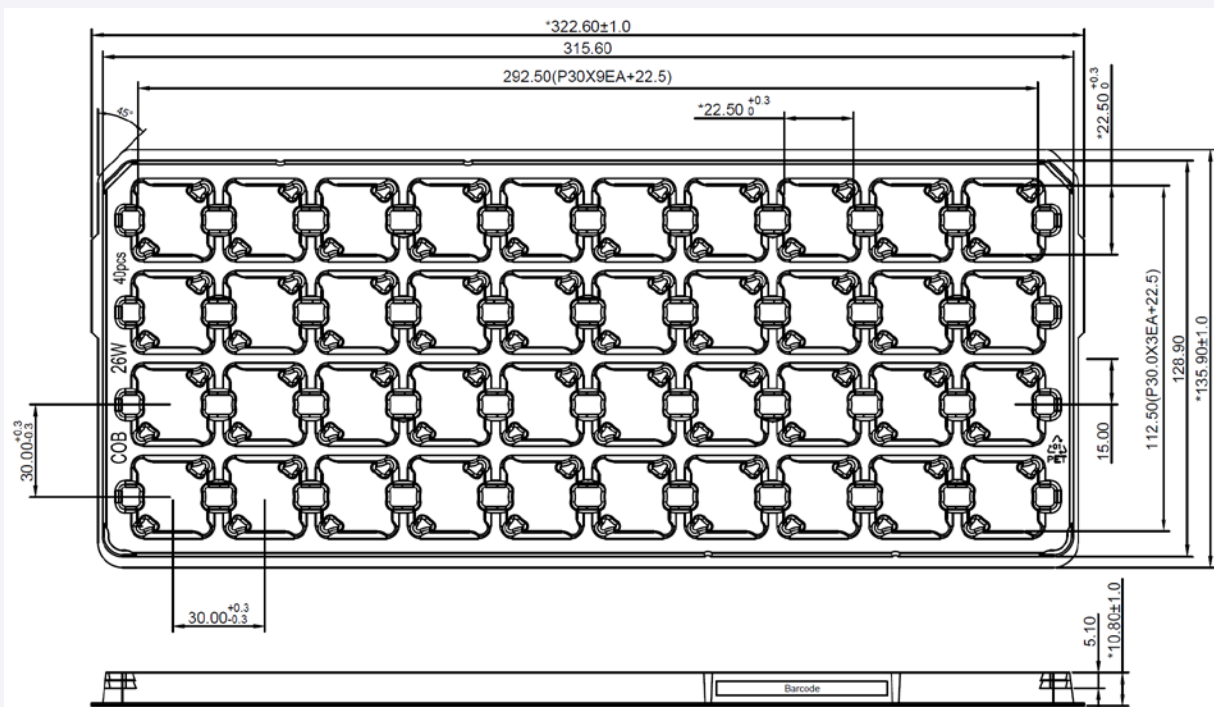

c) Aluminum Vinyl Packing Bag

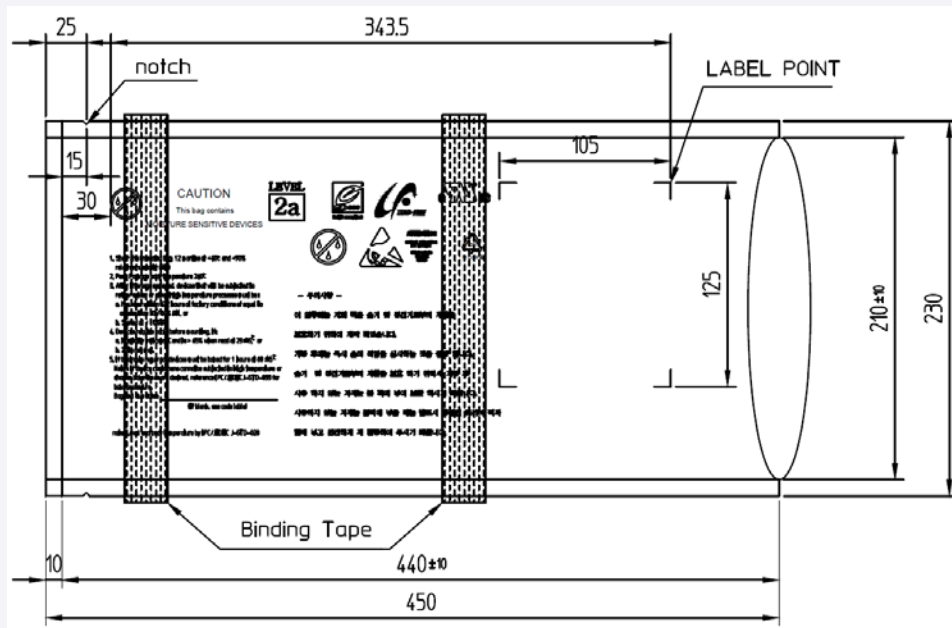

d) Silica Gel & Humidity Indicator Card inside Aluminum Vinyl Packing Bag

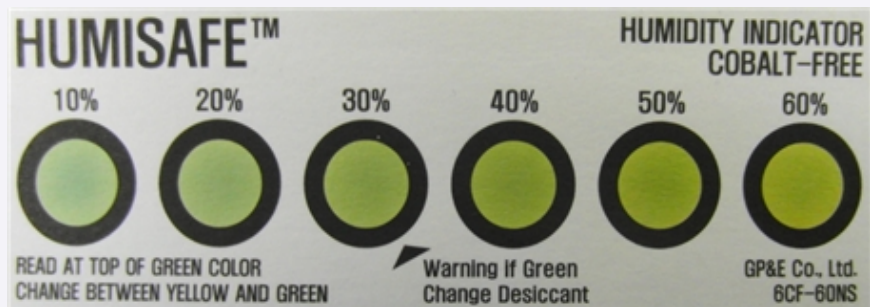

8. Precautions in Handling & Use

- 1) This device should not be used in any type of fluid such as water, oil, organic solvent, etc. When cleaning is required, IPA is recommended as the cleaning agent. Some solvent-based cleaning agent may damage the silicone resins used in the device.
- 2) LEDs must be stored in a clean environment. If the LEDs are to be stored for three months or more after being shipped from Samsung, they should be packed with a nitrogen-filled container (shelf life of sealed bags is 12 months at temperature 0~40 °C, 0~90 % RH).
- 3) After storage bag is opened, device subjected to soldering, solder reflow, or other high temperature processes must be:
 - a. Mounted within 672 hours (28 days) at an assembly line with a condition of no more than 30 °C / 60 % RH, or
 - b. Stored at <10 % RH
- 4) Repack unused products with anti-moisture packing, fold to close any opening and then store in a dry place.
- 5) Devices require baking before mounting, if humidity card reading is >60 % at 23 ± 5 °C.
- 6) Devices must be baked for 1 hour at 60 ± 5 °C, if baking is required.
- 7) The LEDs are sensitive to the static electricity and surge current. It is recommended to use a wrist band or anti-electrostatic glove when handling the LEDs. If voltage exceeding the absolute maximum rating is applied to LEDs, it may cause damage or even destruction to LED devices. Damaged LEDs may show some unusual characteristics such as increase in leakage current, lowered turn-on voltage, or abnormal lighting of LEDs at low current.
- 8) VOCs (Volatile Organic Compounds) can be generated from adhesives, flux, hardener or organic additives used in luminaires (fixtures). Transparent LED silicone encapsulant is permeable to those chemicals and they may lead to a discoloration of encapsulant when they exposed to heat or light. This phenomenon can cause a significant loss of light emitted (output) from the luminaires. In order to prevent these problems, we recommend users to know the physical properties of materials used in luminaires and they must be carefully selected.
- 9) The resin area is very sensitive, please do not handle, press, touch, rub, clean, or pick by with tweezers on it. Instead, please pick at the handling area as indicated below.

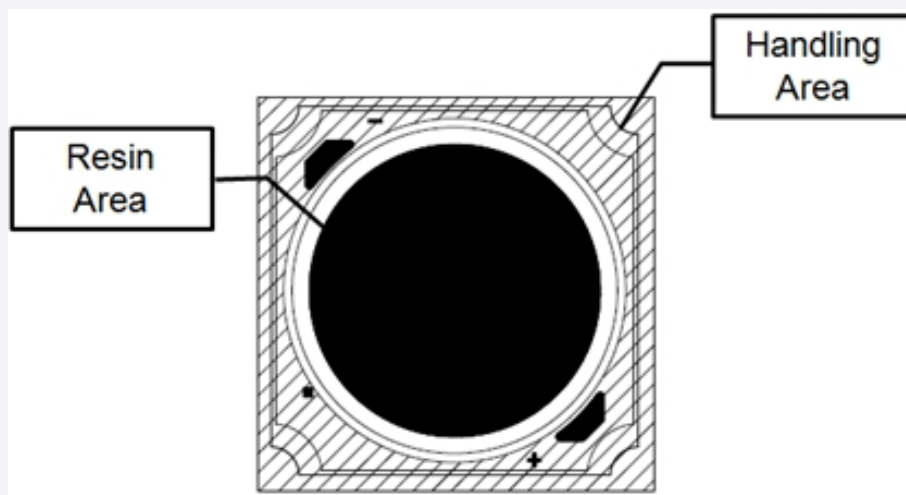

Legal and additional information.

[About Samsung Electronics Co., Ltd.](#)

Samsung Electronics Co., Ltd. inspires the world and shapes the future with transformative ideas and technologies, redefining the worlds of TVs, smartphones, wearable devices, tablets, cameras, digital appliances, printers, medical equipment, network systems and semiconductors.

We are also leading in the Internet of Things space through, among others, our Digital Health and Smart Home initiatives. We employ 307,000 people across 84 countries. To discover more, please visit our official website at www.samsung.com and our official blog at global.samsungtomorrow.com.

Copyright © 2015 Samsung Electronics Co., Ltd. All rights reserved.

Samsung is a registered trademark of Samsung Electronics Co., Ltd.

Specifications and designs are subject to change without notice. Non-metric weights and measurements are approximate. All data were deemed correct at time of creation. Samsung is not liable for errors or omissions. All brand, product, service names and logos are trademarks and/or registered trademarks of their respective owners and are hereby recognized and acknowledged.

Samsung Electronics Co., Ltd.

95, Samsung 2-ro

Giheung-gu

Yongin-si, Gyeonggi-do, 446-711



KOREA

www.samsungled.com



Looking for pricing, stock, or lifecycle information?

Click below to explore more details on WIN SOURCE:

-  [View SPHWW1HDND25YHU33G on WIN SOURCE](#)
-  [Samsung Information](#)

Optimize Your Supply Chain with WIN SOURCE Solutions

-  Global Sourcing Solution
-  Obsolete Management
-  Cost Control Management
-  Shortage Management
-  Alternative Solution
-  Excess Inventory Management