



THE DATASHEET OF CY29948AXI



2.5 V or 3.3 V, 200 MHz, 1:12 Clock Distribution Buffer

Features

- 2.5 V or 3.3 V operation
- 200 MHz clock support
- LVPECL or LVCMOS/LVTTL clock input
- LVCMOS-/LVTTTL-compatible inputs
- 12 clock outputs: drive up to 24 clock lines
- Synchronous Output Enable
- Output three-state control
- 150 ps typical output-to-output skew
- Pin compatible with MPC948, MPC948L, MPC9448
- Available in Commercial and Industrial temp. range
- 32-pin TQFP package

Functional Description

The CY29948 is a low-voltage 200 MHz clock distribution buffer with the capability to select either a differential LVPECL or a LVCMOS/LVTTL compatible input clock. The two clock sources can be used to provide for a test clock as well as the primary system clock. All other control inputs are LVCMOS/LVTTL compatible. The 12 outputs are LVCMOS or LVTTTL compatible and can drive 50 Ω series or parallel terminated transmission lines. For series terminated transmission lines, each output can drive one or two traces giving the device an effective fanout of 1:24. The outputs can also be three-stated via the three-state input TS#. Low output-to-output skews make the CY29948 an ideal clock distribution buffer for nested clock trees in the most demanding of synchronous systems.

The CY29948 also provides a synchronous output enable input for enabling or disabling the output clocks. Since this input is internally synchronized to the input clock, potential output glitching or runt pulse generation is eliminated.

For a complete list of related documentation, [click here](#).

Block Diagram

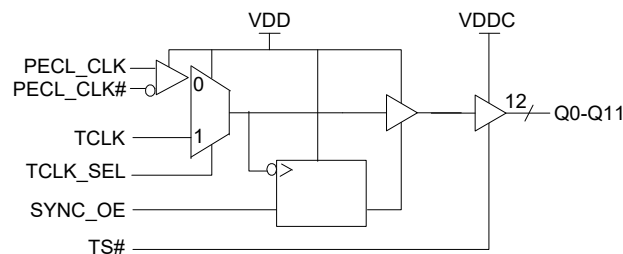

Contents

Pin Configuration	3	Acronyms	11
Pin Description	3	Document Conventions	11
Output Enable/Disable	4	Units of Measure	11
Maximum Ratings	5	Document Revision History	12
DC Parameters	5	Sales, Solutions, and Legal Information	13
Thermal Resistance	6	Worldwide Sales and Design Support	13
AC Parameters	6	Products	13
Ordering Information	9	PSoC® Solutions	13
Ordering Code Definitions	9	Cypress Developer Community	13
Package Diagrams	10	Technical Support	13

Pin Configuration

Figure 1. 32-pin TQFP pinout

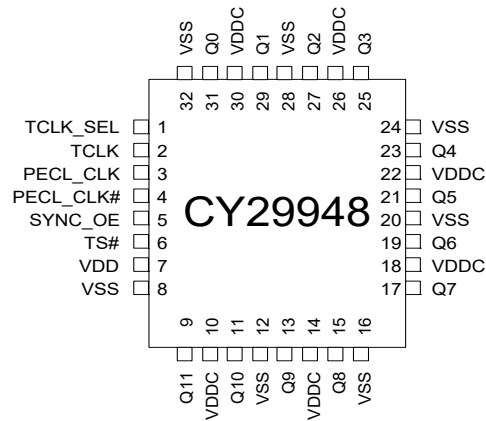

Pin Description

Pin	Name	PWR	I/O [1]	Description
3	PECL_CLK	–	I, PU	PECL Input Clock
4	PECL_CLK#	–	I, PD	PECL Input Clock
2	TCLK	–	I, PU	External Reference/Test Clock Input
9, 11, 13, 15, 17, 19, 21, 23, 25, 27, 29, 31	Q(11:0)	VDDC	O	Clock Outputs
1	TCLK_SEL	–	I, PU	Clock Select Input. When LOW, PECL clock is selected. When HIGH TCLK is selected.
5	SYNC_OE	–	I, PU	Output Enable Input. When asserted HIGH, the outputs are enabled. When set LOW the outputs are disabled in a LOW state.
6	TS#	–	I, PU	Three-state Control Input. When asserted LOW, the output buffers are three-stated. When set HIGH, the output buffers are enabled.
10, 14, 18, 22, 26, 30	VDDC	–	–	2.5 V or 3.3 V Power Supply for Output Clock Buffers
7	VDD	–	–	2.5 V or 3.3 V Power Supply
8, 12, 16, 20, 24, 28, 32	VSS	–	–	Common Ground

Note

1. PD = Internal pull-down, PU = Internal pull-up.

Output Enable/Disable

The CY29948 features a control input to enable or disable the outputs. This data is latched on the falling edge of the input clock. When SYNC_OE is asserted LOW, the outputs are disabled in a LOW state. When SYNC_OE is set HIGH, the outputs are enabled as shown in [Figure 2](#).

Figure 2. SYNC_OE Timing Diagram

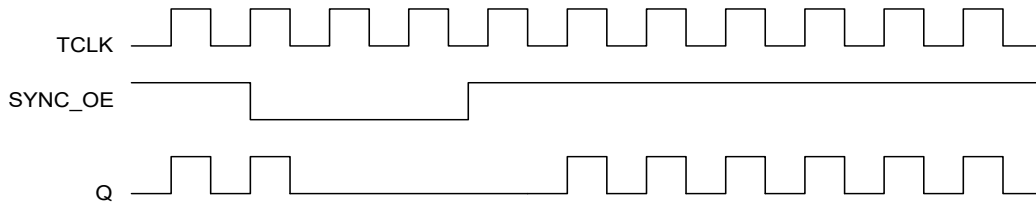

Maximum Ratings

Exceeding maximum ratings ^[2] may shorten the useful life of the device. User guidelines are not tested.

Maximum Input Voltage Relative to V_{SS}	$V_{SS} - 0.3$ V
Maximum Input Voltage Relative to V_{DD}	$V_{DD} + 0.3$ V
Storage Temperature	-65 °C to + 150 °C
Operating Temperature	-40 °C to +85 °C
Maximum ESD protection	2 kV

Maximum Power Supply	5.5 V
Maximum Input Current	±20 mA

This device contains circuitry to protect the inputs against damage due to high static voltages or electric field; however, precautions should be taken to avoid application of any voltage higher than the maximum rated voltages to this circuit. For proper operation, V_{in} and V_{out} should be constrained to the range:

$$V_{SS} < (V_{in} \text{ or } V_{out}) < V_{DD}$$

Unused inputs must always be tied to an appropriate logic voltage level (either V_{SS} or V_{DD}).

DC Parameters

$V_{DD} = V_{DDC} = 3.3$ V ± 10% or 2.5 V ± 5%, over the specified temperature range.

Parameter	Description	Conditions	Min	Typ	Max	Unit
V_{IL}	Input Low Voltage	$V_{DD} = 3.3$ V, PECL_CLK single ended	1.49	–	1.825	V
		$V_{DD} = 2.5$ V, PECL_CLK single ended	1.10	–	1.45	
		All other inputs	V_{SS}	–	0.8	
V_{IH}	Input High Voltage	$V_{DD} = 3.3$ V, PECL_CLK single ended	2.135	–	2.42	V
		$V_{DD} = 2.5$ V, PECL_CLK single ended	1.75	–	2.0	
		All other inputs	2.0	–	V_{DD}	
I_{IL}	Input Low Current ^[3]		–	–	-100	µA
I_{IH}	Input High Current ^[3]		–	–	100	
V_{PP}	Peak-to-Peak Input Voltage PECL_CLK		300	–	1000	mV
V_{CMR}	Common Mode Range ^[4] PECL_CLK	$V_{DD} = 3.3$ V	$V_{DD} - 2.0$	–	$V_{DD} - 0.6$	V
		$V_{DD} = 2.5$ V	$V_{DD} - 1.2$	–	$V_{DD} - 0.6$	
V_{OL}	Output Low Voltage ^[5]	$I_{OL} = 20$ mA	–	–	0.4	V
V_{OH}	Output High Voltage ^[5]	$I_{OH} = -20$ mA, $V_{DD} = 3.3$ V	2.5	–	–	V
		$I_{OH} = -20$ mA, $V_{DD} = 2.5$ V	1.8	–	–	
I_{DDQ}	Quiescent Supply Current		–	5	7	mA
I_{DD}	Dynamic Supply Current	$V_{DD} = 3.3$ V, Outputs @ 100 MHz, $C_L = 30$ pF	–	180	–	mA
		$V_{DD} = 3.3$ V, Outputs @ 160 MHz, $C_L = 30$ pF	–	270	–	
		$V_{DD} = 2.5$ V, Outputs @ 100 MHz, $C_L = 30$ pF	–	125	–	
		$V_{DD} = 2.5$ V, Outputs @ 160 MHz, $C_L = 30$ pF	–	190	–	
Z_{out}	Output Impedance	$V_{DD} = 3.3$ V	12	15	18	Ω
		$V_{DD} = 2.5$ V	14	18	22	
C_{in}	Input Capacitance		–	4	–	pF

Notes

- Multiple Supplies:** The voltage on any input or I/O pin cannot exceed the power pin during power-up. Power supply sequencing is not required.
- Inputs have pull-up/pull-down resistors that effect input current.
- The V_{CMR} is the difference from the most positive side of the differential input signal. Normal operation is obtained when the "High" input is within the V_{CMR} range and the input lies within the V_{PP} specification.
- Driving series or parallel terminated 50 Ω (or 50 Ω to $V_{DD}/2$) transmission lines.

Thermal Resistance

Parameter ^[6]	Description	Test Conditions	32-pin TQFP	Unit
θ_{JA}	Thermal resistance (junction to ambient)	Test conditions follow standard test methods and procedures for measuring thermal impedance, in accordance with EIA/JESD51.	65	°C/W
θ_{JC}	Thermal resistance (junction to case)		12	°C/W

AC Parameters

$V_{DD} = V_{DDC} = 3.3 \text{ V} \pm 10\%$ or $2.5 \text{ V} \pm 5\%$, over the specified operating range.

Parameter ^[7]	Description	Conditions	Min	Typ	Max	Unit
F_{max}	Input Frequency ^[8]	$V_{DD} = 3.3 \text{ V}$	–	–	200	MHz
		$V_{DD} = 2.5 \text{ V}$	–	–	170	
T_{pd}	PECL_CLK to Q Delay ^[8]	$V_{DD} = 3.3 \text{ V}$	4.0	–	8.0	ns
	TCLK to Q Delay ^[8]		4.4	–	8.9	
	PECL_CLK to Q Delay ^[8]	$V_{DD} = 2.5 \text{ V}$	6.0	–	10.0	
	TCLK to Q Delay ^[8]		6.4	–	10.9	
F_{outDC}	Output Duty Cycle ^[8, 9, 10]	Measured at $V_{DD}/2$	45	–	55	%
t_{pZL}, t_{pZH}	Output Enable Time (all outputs)		2	–	10	ns
t_{pLZ}, t_{pHZ}	Output Disable Time (all outputs)		2	–	10	ns
T_{skew}	Output-to-Output Skew ^[8, 10]		–	150	250	ps
$T_{skew(pp)}$	Part-to-Part Skew ^[11]	PECL_CLK to Q	–	–	1.5	ns
		TCLK to Q	–	–	2.0	
T_s	Set-up Time ^[8, 12]	SYNC_OE to PECL_CLK	1.0	–	–	ns
		SYNC_OE to TCLK	0.0	–	–	
T_h	Hold Time ^[8, 12]	PECL_CLK to SYNC_OE	0.0	–	–	ns
		TCLK to SYNC_OE	1.0	–	–	
T_r/T_f	Output Clocks Rise/Fall Time ^[10]	0.8 V to 2.0 V, $V_{DD} = 3.3 \text{ V}$	0.20	–	1.0	ns
		0.6 V to 1.8 V, $V_{DD} = 2.5 \text{ V}$	0.20	–	1.3	

Notes

6. These parameters are guaranteed by design and are not tested.
7. Parameters are guaranteed by design and characterization. Not 100% tested in production. All parameters specified with loaded outputs.
8. Outputs driving 50 Ω transmission lines.
9. 50% input duty cycle.
10. See [Figure 3 on page 7](#) and [Figure 4 on page 7](#).
11. Part-to-Part skew at a given temperature and voltage.
12. Setup and hold times are relative to the falling edge of the input clock.

Figure 3. LVCMOS_CLK CY29948 Test Reference for $V_{CC} = 3.3\text{ V}$ and $V_{CC} = 2.5\text{ V}$

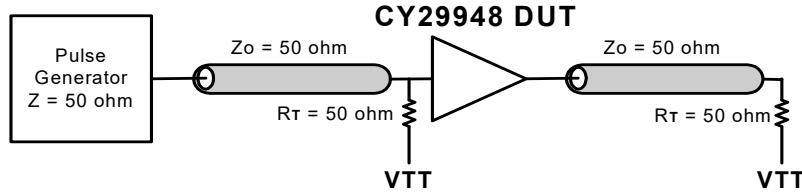

Figure 4. PECL_CLK CY29948 Test Reference for $V_{CC} = 3.3\text{ V}$ and $V_{CC} = 2.5\text{ V}$

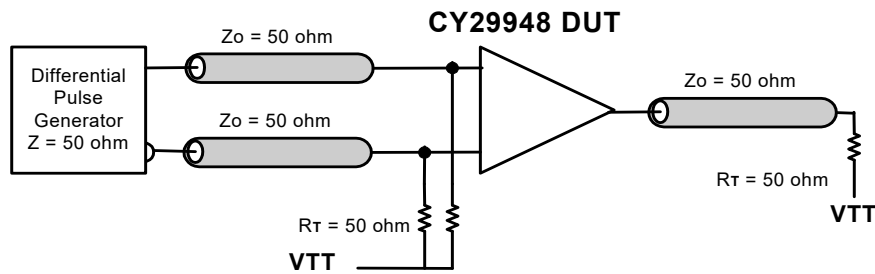

Figure 5. Propagation Delay (t_{PD}) Test Reference

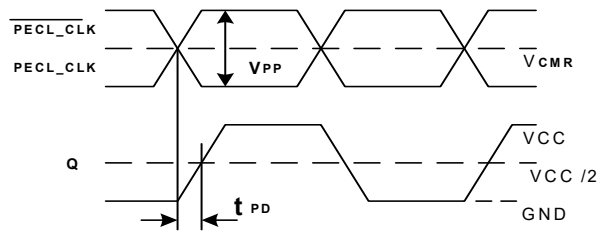

Figure 6. LVCMOS Propagation Delay (t_{PD}) Test Reference

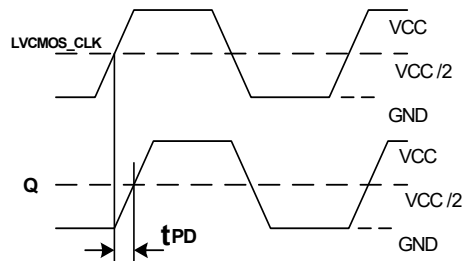

Figure 7. Output Duty Cycle (F_{outDC})

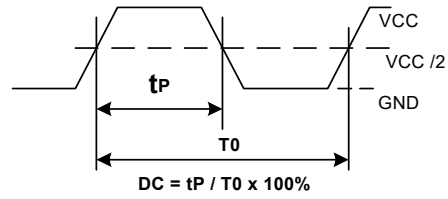
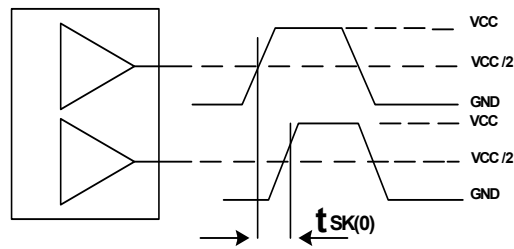

Figure 8. Output-to-Output Skew $t_{sk(0)}$



Ordering Information

Part Number	Package Type	Production Flow
Pb-free		
CY29948AXC	32-pin TQFP	Commercial, 0 °C to +70 °C
CY29948AXCT	32-pin TQFP – Tape and Reel	Commercial, 0 °C to +70 °C
CY29948AXI	32-pin TQFP	Industrial, –40 °C to +85 °C
CY29948AXIT	32-pin TQFP – Tape and Reel	Industrial, –40 °C to +85 °C

Ordering Code Definitions

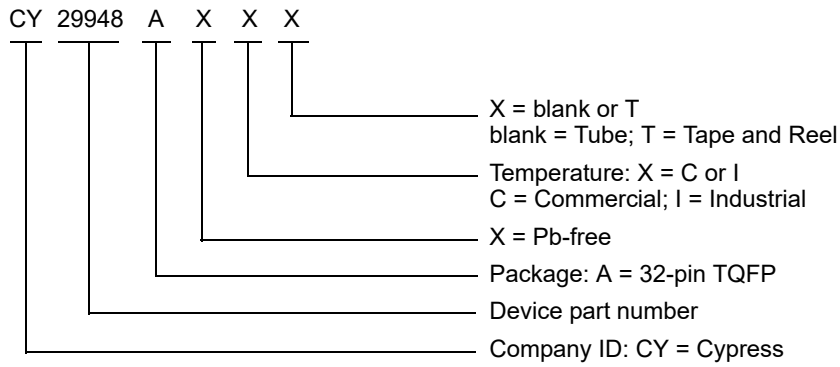

Package Diagrams

Figure 9. 32-pin TQFP (7 × 7 × 1.0 mm) Package Outline, 51-85063

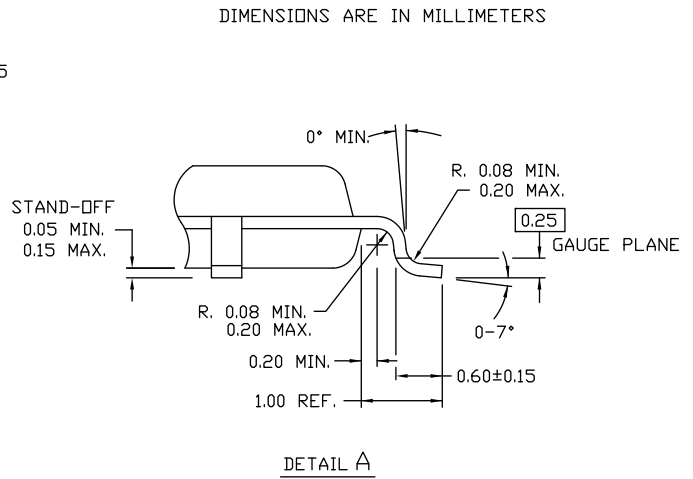
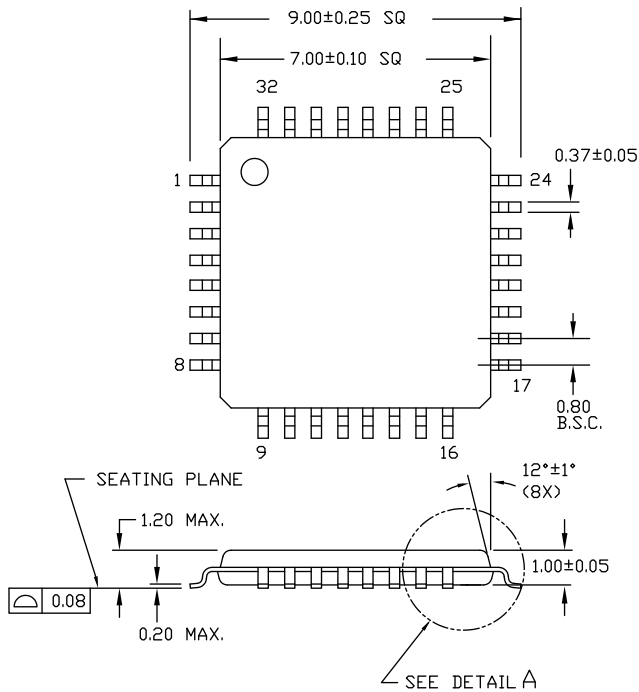

51-85063 *E

Acronyms

Acronym	Description
CMOS	Complementary Metal Oxide Semiconductor
ESD	Electrostatic Discharge
I/O	Input/Output
LVC MOS	Low Voltage Complementary Metal Oxide Semiconductor
LVPECL	Low Voltage Positive Emitter Coupled Logic
LVTTTL	Low Voltage Transistor-Transistor Logic
PLL	Phase Locked Loop
TQFP	Thin Quad Flat Pack

Document Conventions

Units of Measure

Symbol	Unit of Measure
°C	degree Celsius
kV	kilovolt
MHz	megahertz
μA	microampere
mA	milliampere
mm	millimeter
mV	millivolt
ns	nanosecond
Ω	ohm
%	percent
pF	picofarad
ps	picosecond
V	volt

Document Revision History

Document Title: CY29948, 2.5 V or 3.3 V, 200 MHz, 1:12 Clock Distribution Buffer				
Document Number: 38-07288				
Rev.	ECN No.	Orig. of Change	Submission Date	Description of Change
**	111099	BRK	02/13/2002	New data sheet.
*A	116782	HWT	08/14/2002	Added Commercial Temperature Range related information in all instances across the document. Updated Ordering Information : Updated part numbers.
*B	122880	RBI	12/22/2002	Updated Maximum Ratings : Added Note 2 and referred the same note in “maximum ratings”.
*C	428221	RGL	02/21/2006	Updated Ordering Information : Updated part numbers. Updated to new template.
*D	2904731	CXQ	04/05/2010	Updated Ordering Information : Updated part numbers. Updated Package Diagrams : spec 51-85063 – Changed revision from *B to *C. Updated to new template.
*E	3246222	CXQ	05/02/2011	Updated Ordering Information : No change in part numbers. Added Ordering Code Definitions . Added Acronyms and Units of Measure . Updated to new template. Completing Sunset Review.
*F	3859773	AJU	01/07/2013	Updated Ordering Information : Updated part numbers. Updated Package Diagrams : spec 51-85063 – Changed revision from *C to *D.
*G	4345036	XHT	04/14/2014	Updated to new template. Completing Sunset Review.
*H	4586288	XHT	12/03/2014	Updated Functional Description : Added “For a complete list of related documentation, click here. ” at the end.
*I	5275785	PSR	05/18/2016	Added Thermal Resistance . Updated Package Diagrams : spec 51-85063 – Changed revision from *D to *E. Updated to new template.
*J	6142409	XHT	04/17/2018	Updated to new template. Completing Sunset Review.

Sales, Solutions, and Legal Information

Worldwide Sales and Design Support

Cypress maintains a worldwide network of offices, solution centers, manufacturer's representatives, and distributors. To find the office closest to you, visit us at [Cypress Locations](#).

Products

Arm [®] Cortex [®] Microcontrollers	cypress.com/arm
Automotive	cypress.com/automotive
Clocks & Buffers	cypress.com/clocks
Interface	cypress.com/interface
Internet of Things	cypress.com/iot
Memory	cypress.com/memory
Microcontrollers	cypress.com/mcu
PSoC	cypress.com/psoc
Power Management ICs	cypress.com/pmic
Touch Sensing	cypress.com/touch
USB Controllers	cypress.com/usb
Wireless Connectivity	cypress.com/wireless

PSoC[®] Solutions

[PSoC 1](#) | [PSoC 3](#) | [PSoC 4](#) | [PSoC 5LP](#) | [PSoC 6 MCU](#)

Cypress Developer Community

[Community](#) | [Projects](#) | [Video](#) | [Blogs](#) | [Training](#) | [Components](#)

Technical Support

cypress.com/support



© Cypress Semiconductor Corporation, 2002-2018. This document is the property of Cypress Semiconductor Corporation and its subsidiaries, including Spansion LLC ("Cypress"). This document, including any software or firmware included or referenced in this document ("Software"), is owned by Cypress under the intellectual property laws and treaties of the United States and other countries worldwide. Cypress reserves all rights under such laws and treaties and does not, except as specifically stated in this paragraph, grant any license under its patents, copyrights, trademarks, or other intellectual property rights. If the Software is not accompanied by a license agreement and you do not otherwise have a written agreement with Cypress governing the use of the Software, then Cypress hereby grants you a personal, non-exclusive, nontransferable license (without the right to sublicense) (1) under its copyright rights in the Software (a) for Software provided in source code form, to modify and reproduce the Software solely for use with Cypress hardware products, only internally within your organization, and (b) to distribute the Software in binary code form externally to end users (either directly or indirectly through resellers and distributors), solely for use on Cypress hardware product units, and (2) under those claims of Cypress's patents that are infringed by the Software (as provided by Cypress, unmodified) to make, use, distribute, and import the Software solely for use with Cypress hardware products. Any other use, reproduction, modification, translation, or compilation of the Software is prohibited.

TO THE EXTENT PERMITTED BY APPLICABLE LAW, CYPRESS MAKES NO WARRANTY OF ANY KIND, EXPRESS OR IMPLIED, WITH REGARD TO THIS DOCUMENT OR ANY SOFTWARE OR ACCOMPANYING HARDWARE, INCLUDING, BUT NOT LIMITED TO, THE IMPLIED WARRANTIES OF MERCHANTABILITY AND FITNESS FOR A PARTICULAR PURPOSE. No computing device can be absolutely secure. Therefore, despite security measures implemented in Cypress hardware or software products, Cypress does not assume any liability arising out of any security breach, such as unauthorized access to or use of a Cypress product. In addition, the products described in these materials may contain design defects or errors known as errata which may cause the product to deviate from published specifications. To the extent permitted by applicable law, Cypress reserves the right to make changes to this document without further notice. Cypress does not assume any liability arising out of the application or use of any product or circuit described in this document. Any information provided in this document, including any sample design information or programming code, is provided only for reference purposes. It is the responsibility of the user of this document to properly design, program, and test the functionality and safety of any application made of this information and any resulting product. Cypress products are not designed, intended, or authorized for use as critical components in systems designed or intended for the operation of weapons, weapons systems, nuclear installations, life-support devices or systems, other medical devices or systems (including resuscitation equipment and surgical implants), pollution control or hazardous substances management, or other uses where the failure of the device or system could cause personal injury, death, or property damage ("Unintended Uses"). A critical component is any component of a device or system whose failure to perform can be reasonably expected to cause the failure of the device or system, or to affect its safety or effectiveness. Cypress is not liable, in whole or in part, and you shall and hereby do release Cypress from any claim, damage, or other liability arising from or related to all Unintended Uses of Cypress products. You shall indemnify and hold Cypress harmless from and against all claims, costs, damages, and other liabilities, including claims for personal injury or death, arising from or related to any Unintended Uses of Cypress products.

Cypress, the Cypress logo, Spansion, the Spansion logo, and combinations thereof, WICED, PSOC, CapSense, EZ-USB, F-RAM, and Traveo are trademarks or registered trademarks of Cypress in the United States and other countries. For a more complete list of Cypress trademarks, visit cypress.com. Other names and brands may be claimed as property of their respective owners.

Looking for pricing, stock, or lifecycle information?

Click below to explore more details on WIN SOURCE:

-  [View CY29948AXI on WIN SOURCE](#)
-  [Cypress Semiconductor Corp](#) Information

Optimize Your Supply Chain with WIN SOURCE Solutions

-  Global Sourcing Solution
-  Obsolete Management
-  Cost Control Management
-  Shortage Management
-  Alternative Solution
-  Excess Inventory Management