



**THE DATASHEET OF
SPHWW1HDNE25YHW3B3**



High Power LED Series Chip on Board

LCo40B - Gen3



High efficacy COB LED package,
well-suited for use in spotlight applications

Features & Benefits

- Chip on Board (COB) solution makes it easy to design in
- Simple assembly reduces manufacturing cost
- Low thermal resistance
- InGaN/GaN MQW LED with long time reliability
- Completed 6,000 hours of LM-80 Testing

Applications

- Spotlight / Downlight
- LED Retrofit Bulbs
- Outdoor Illumination



Table of Contents

1.	Characteristics	-----	3
2.	Product Code Information	-----	5
3.	Typical Characteristics Graphs	-----	10
4.	Outline Drawing & Dimension	-----	15
5.	Reliability Test Items & Conditions	-----	16
6.	Label Structure	-----	17
7.	Packing Structure	-----	18
8.	Precautions in Handling & Use	-----	20

1. Characteristics

a) Absolute Maximum Rating

Item	Symbol	Rating	Unit	Condition
Ambient / Operating Temperature	T_a	-40 ~ +105	°C	-
Storage Temperature	T_{stg}	-40 ~ +120	°C	-
LED Junction Temperature	T_j	150	°C	-
Case Temperature	T_c	105	°C	*Note
Forward Current	I_F	1900	mA	-
Power Dissipation	P_D	70.3	W	-
ESD (HBM)	-	±2	kV	-
ESD (MM)	-	±0.5	kV	-

b) Electro-optical Characteristics ($I_F = 1080 \text{ mA}$, $T_c = 25 \text{ °C}$)

Item	Unit	Rank	Min.	Typ.	Max.
Forward Voltage (V_F)	V	YH	32.5	35.5	38.5
Color Rendering Index (R_a)	-	3	70	-	-
		5	80 ($R_9 > 0$)	-	-
		7	90	-	-
		8	95	-	-
Thermal Resistance (junction to chip point)	°C/W		-	0.8	-
Beam Angle	°		-	115	-
Nominal Power	W			38.3	

Notes:

- 1) The COB is tested in pulsed condition at rated test current (10 ms pulse width) and rated temperature ($T_j = T_c = T_a = 25 \text{ °C}$)
- 2) Samsung maintains measurement tolerance of: forward voltage = ±5 %, CRI = ±1
- 3) Refer to the derating curve, '3. Typical Characteristics Graph' designed within the range.

c) Luminous Flux Characteristics ($I_F = 1080 \text{ mA}$)

CRI (R _a)	Nominal CCT (K)	Flux Rank	Flux Bin	Sorting ¹⁾ @ T _c = 25 °C (lm)		Calculated Flux ²⁾ @ T _c = 85 °C (lm)		
				Min.	Max.	Min.	Max.	
80	2700	B3	46	5450	5800	4960	5278	
			47	5800	6261	5278	5698	
	3000	B3	46	5615	5975	5110	5437	
			47	5975	6434	5437	5855	
	3500	B3	45	5480	5860	4987	5333	
			46	5860	6332	5333	5762	
	4000	B3	45	5635	6025	5128	5483	
			46	6025	6515	5483	5929	
	5000	B3	45	5690	6085	5178	5537	
			46	6085	6576	5537	5984	
	5700	B3	45	5690	6085	5178	5537	
			46	6085	6576	5537	5984	
	90	2700	B3	44	4126	4456	3755	4055
				45	4459	4906	4058	4464
46				4906	5345	4464	4864	
3000		B3	44	4210	4546	3831	4137	
			45	4546	4996	4137	4546	
			46	4996	5446	4546	4956	
3500		B3	44	4336	4683	3946	4262	
			45	4683	5133	4262	4671	
			46	5133	5589	4671	5086	
4000		B3	44	4462	4819	4060	4385	
			45	4819	5269	4385	4795	
			46	5269	5742	4795	5225	

Notes:

- 1) The COB is tested in pulsed condition at rated test current (10 ms pulse width) and rated temperature ($T_j = T_c = T_a = 25 \text{ °C}$)
- 2) Calculated flux values are for reference only
- 3) Samsung maintains measurement tolerance of: luminous flux = $\pm 7 \%$, CRI = ± 1

2. Product Code Information

1	2	3	4	5	6	7	8	9	10	11	12	13	14	15	16	17	18
S	P	H	C	W	1	H	D	N	E	2	5	Y	H	R	T	B	3

Digit	PKG Information	Code	Specification
1 2 3	Samsung Package High Power	SPH	
4 5	Color	WW CW	Warm White (T/U/V/W Ranks) Cool White (Q/R Ranks)
6	Product Version	1	
7 8	Form Factor	HD	COB
9	Lens Type	N	No lens
10	Internal Code	E	LC040
11	Chip Type	2	
12	CRI & Sorting Temperature	5 7	Min. 80 Min. 90
13 14	Forward Voltage (V)	YH	32.5~38.5
15	CCT (K)	W V U T R Q	2700 K WA, WB (MacAdam Ellipse) 3000 K VA, VB (MacAdam Ellipse) VW, VX, VY, VZ (ANSI bin) 3500 K UA, UB (MacAdam Ellipse) 4000 K TA, TB (MacAdam Ellipse) TW, TX, TY, TZ (ANSI bin) 5000 K RA (MacAdam Ellipse) RW, RX, RY, RZ (ANSI bin) 5700 K QW, QX, QY, QZ (ANSI bin)
16	MacAdam / ANSI	2 3 T	MacAdam 2-step MacAdam 3-step ANSI bin
17 18	Luminous Flux	B3	Bin Code: 45, 46 (80 CRI); 44, 45, 46 (90 CRI);

a) Binning Structure ($I_F = 1080 \text{ mA}$, $T_c = 25 \text{ }^\circ\text{C}$)

CRI (R _a) Min.	Nominal CCT (K)	Product Code	V _F Rank	Color Rank	Chrom. Bin	Flux Rank	Flux Bin	Flux Range (Φ _v , lm)
80	2700	SPHWW1HDNE25YHW2B3	YH	W2	WB	B3	46	5450 ~ 5800
							47	5800 ~ 6261
		SPHWW1HDNE25YHW3B3	YH	W3	WA, WB	B3	46	5450 ~ 5800
							47	5800 ~ 6261
	3000	SPHWW1HDNE25YHV2B3	YH	V2	VB	B3	46	5615 ~ 5975
							47	5975 ~ 6434
		SPHWW1HDNE25YHV3B3	YH	V3	VA, VB	B3	46	5615 ~ 5975
							47	5975 ~ 6434
	3500	SPHWW1HDNE25YHU2B3	YH	U2	UB	B3	45	5480 ~ 5860
							46	5860 ~ 6332
		SPHWW1HDNE25YHU3B3	YH	U3	UA, UB	B3	45	5480 ~ 5860
							46	5860 ~ 6332
	4000	SPHWW1HDNE25YHT2B3	YH	T2	TB	B3	45	5635 ~ 6025
							46	6025 ~ 6515
		SPHWW1HDNE25YHT3B3	YH	T3	TA, TB	B3	45	5635 ~ 6025
							46	6025 ~ 6515
	5000	SPHCW1HDNE25YHR3B3	YH	R3	RA	B3	45	5690 ~ 6085
							46	6085 ~ 6576
		SPHCW1HDNE25YHRTB3	YH	RT	RW, RX, RY, RZ	B3	45	5690 ~ 6085
							46	6085 ~ 6576
	5700	SPHCW1HDNE25YHQT B3	YH	QT	QW, QX, QY, QZ	B3	45	5690 ~ 6085
							46	6085 ~ 6576

a) Binning Structure ($I_F = 1080 \text{ mA}$, $T_c = 25 \text{ }^\circ\text{C}$)

CRI (R_a) Min.	Nominal CCT (K)	Product Code	V_F Rank	Color Rank	Chrom. Bin	Flux Rank	Flux Bin	Flux Range (Φ_v , lm)
90	2700	SPHWW1HDNE27YHW2B3	YH	W2	WB	B3	44	4126 ~ 4456
							45	4459 ~ 4906
							46	4906 ~ 5345
		SPHWW1HDNE27YHW3B3	YH	W3	WA, WB	B3	44	4126 ~ 4456
							45	4459 ~ 4906
							46	4906 ~ 5345
	3000	SPHWW1HDNE27YHV2B3	YH	V2	VB	B3	44	4210 ~ 4546
							45	4546 ~ 4996
							46	4996 ~ 5446
		SPHWW1HDNE27YHV3B3	YH	V3	VA, VB	B3	44	4210 ~ 4546
							45	4546 ~ 4996
							46	4996 ~ 5446
	3500	SPHWW1HDNE27YHU2B3	YH	U2	UB	B3	44	4336 ~ 4683
							45	4683 ~ 5133
							46	5133 ~ 5589
		SPHWW1HDNE27YHU3B3	YH	U3	UA, UB	B3	44	4336 ~ 4683
							45	4683 ~ 5133
							46	5133 ~ 5589
	4000	SPHWW1HDNE27YHT2B3	YH	T2	TB	B3	44	4462 ~ 4819
							45	4819 ~ 5269
							46	5269 ~ 5742
		SPHWW1HDNE27YHT3B3	YH	T3	TA, TB	B3	44	4462 ~ 4819
							45	4819 ~ 5269
							46	5269 ~ 5742

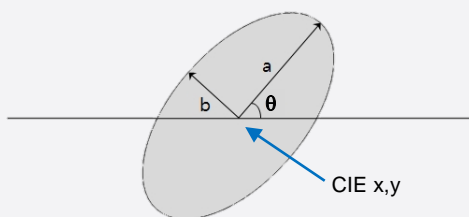
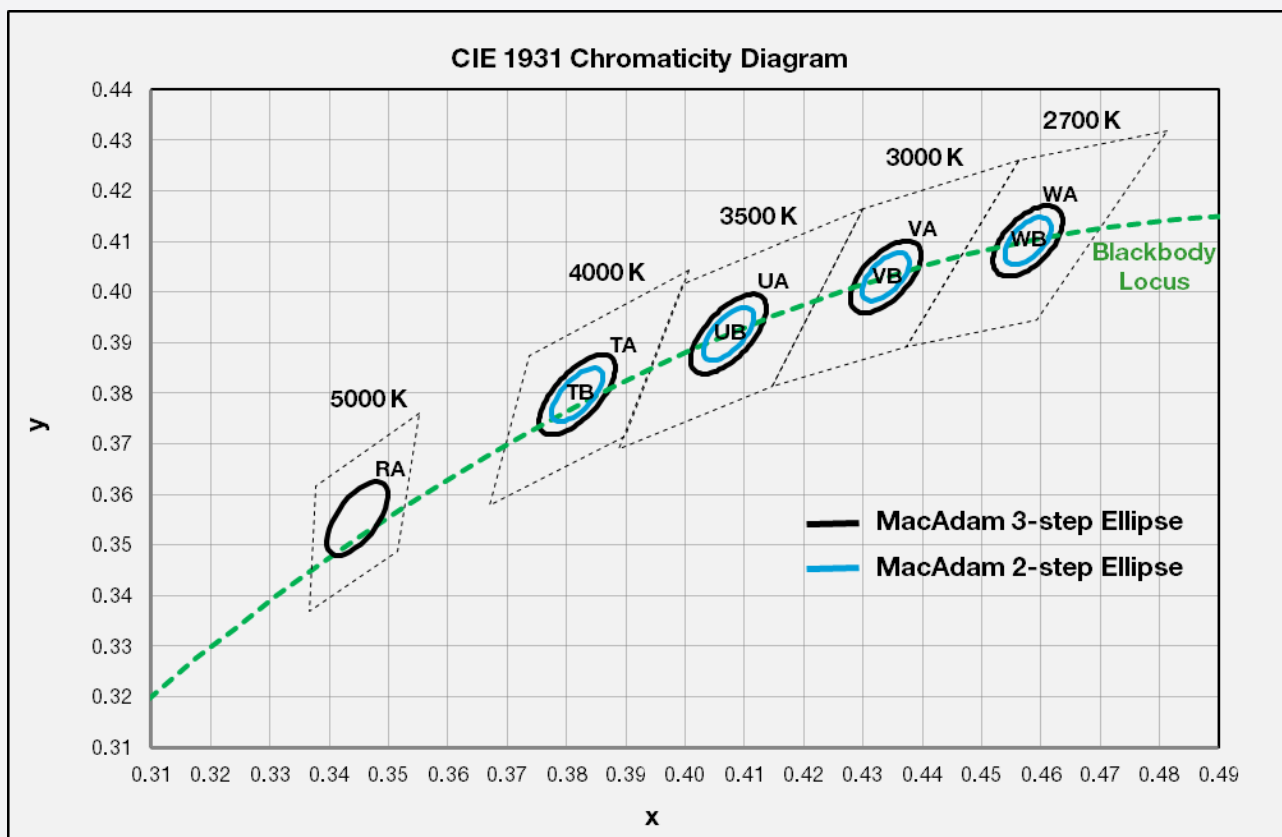
b) Chromaticity Region & Coordinates ($I_F = 1080 \text{ mA}$, $T_a = 25 \text{ }^\circ\text{C}$)

MacAdam Ellipse (WA, WB)					
Step	CIE x	CIE y	θ	a	b
2-step	0.4578	0.4101	53.70	0.0054	0.0028
3-step	0.4578	0.4101	53.70	0.0081	0.0042

MacAdam Ellipse (VA, VB)					
Step	CIE x	CIE y	θ	a	b
2-step	0.4338	0.403	53.22	0.0056	0.0027
3-step	0.4338	0.4030	53.22	0.0083	0.0041

MacAdam Ellipse (UA, UB)					
Step	CIE x	CIE y	θ	a	b
2-step	0.4073	0.3917	54.00	0.0062	0.0028
3-step	0.4073	0.3917	54.00	0.0093	0.0041

MacAdam Ellipse (TA, TB)					
Step	CIE x	CIE y	θ	a	b
2-step	0.3818	0.3797	53.72	0.0063	0.0027
3-step	0.3818	0.3797	53.72	0.0094	0.0040

MacAdam Ellipse (RA)					
Step	CIE x	CIE y	θ	a	b
3-step	0.3447	0.3553	59.62	0.0082	0.0035

Note:

Samsung maintains measurement tolerance of: $C_x, C_y = \pm 0.005$

3. Typical Characteristics Graphs

a) Spectrum Distribution ($I_f = 1080 \text{ mA}$, $T_c = 25 \text{ }^\circ\text{C}$)

CCT: 2700 K (80 CRI)

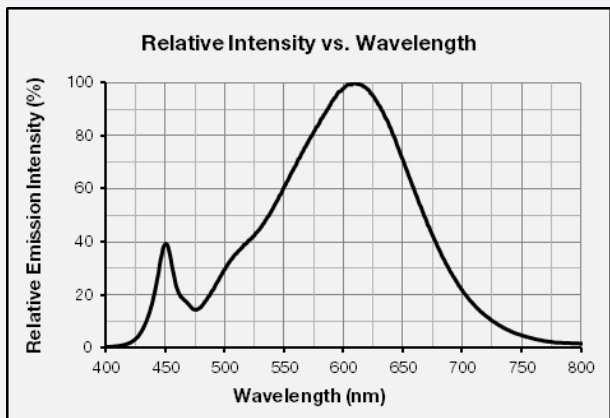

CCT: 3000 K (80 CRI)

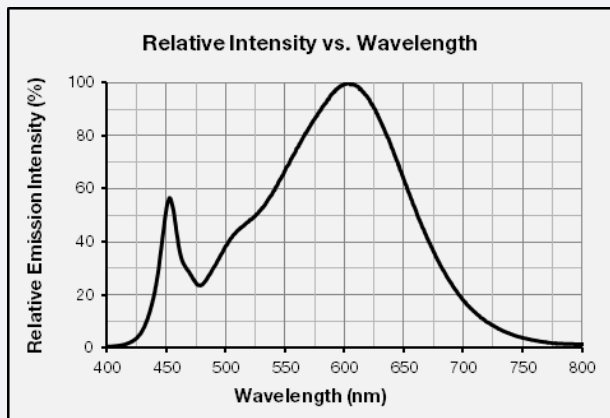

CCT: 3500 K (80 CRI)

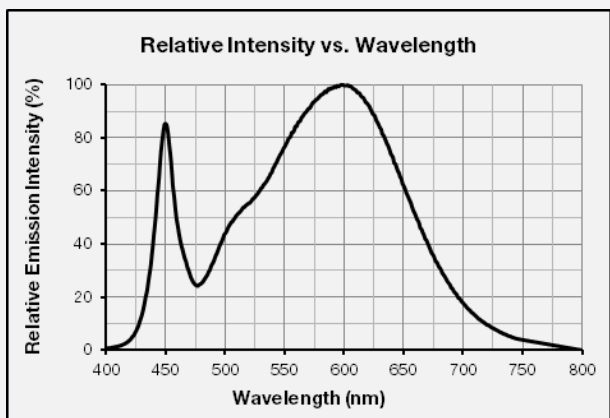

CCT: 4000 K (80 CRI)

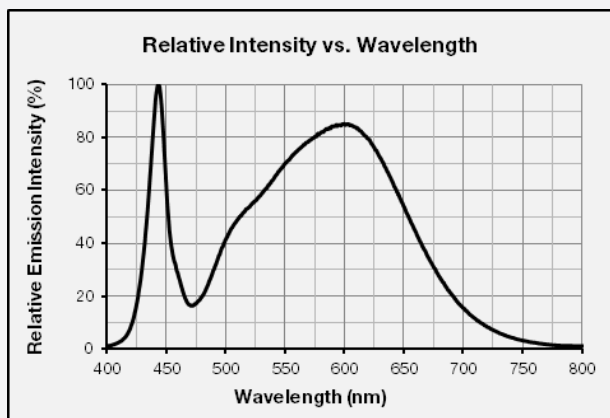

CCT: 5000 K (80 CRI)

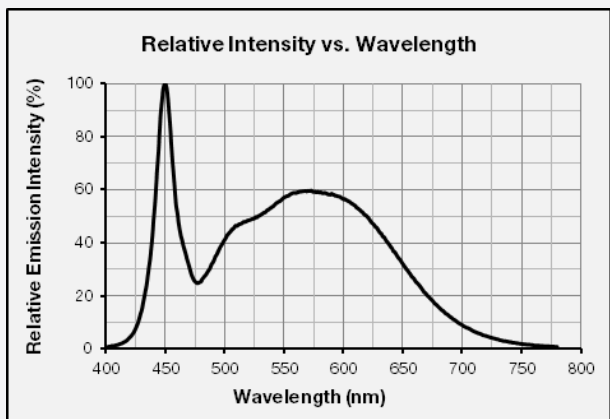

CCT: 5700 K (80 CRI)

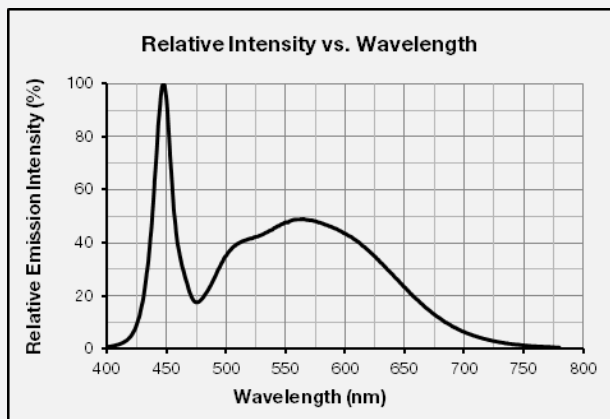

CCT: 2700 K (90 CRI)

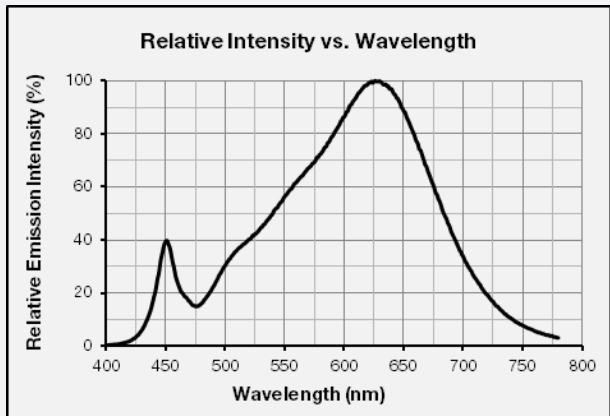

CCT: 3000 K (90 CRI)

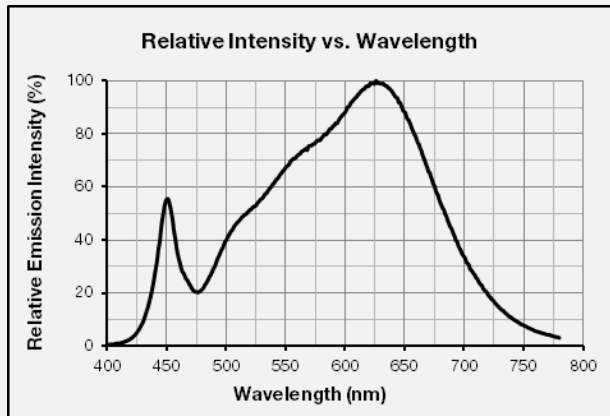

CCT: 3500 K (90 CRI)

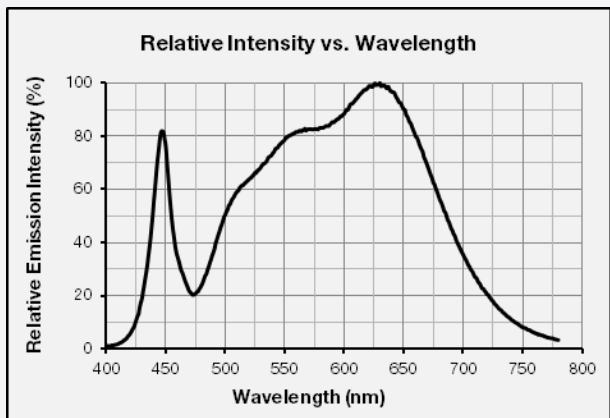

CCT: 4000 K (90 CRI)

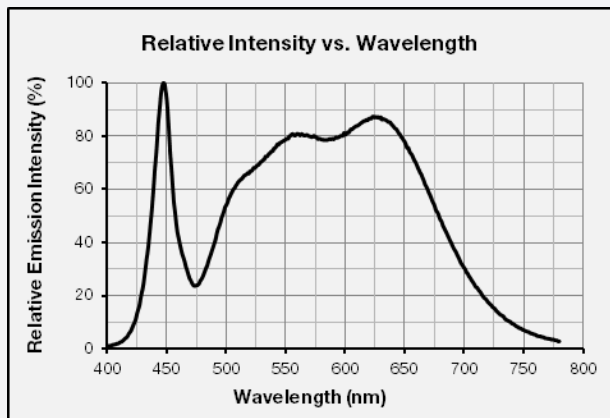

b) Forward Current Characteristics (T_c = 25 °C)

80 CRI

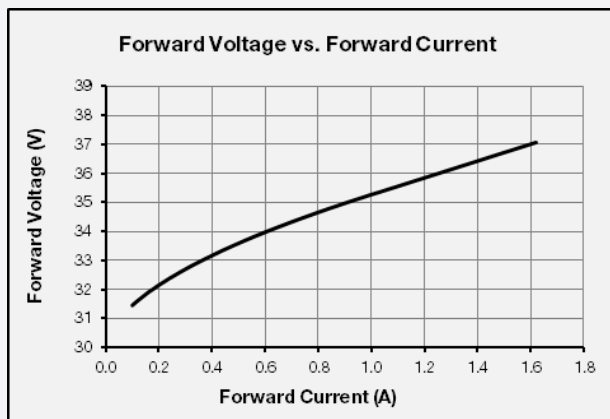
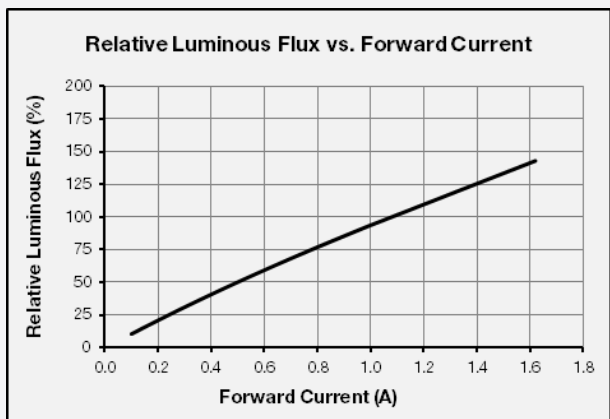

90 CRI

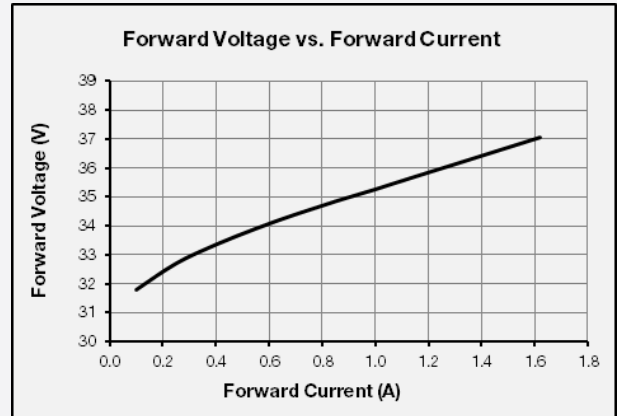
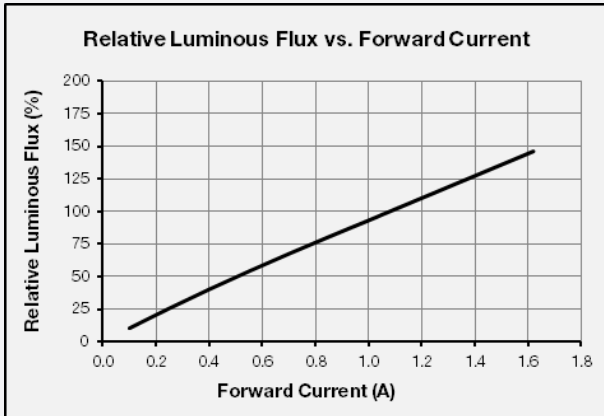

c) Temperature Characteristics ($I_F = 1080 \text{ mA}$)

80 CRI

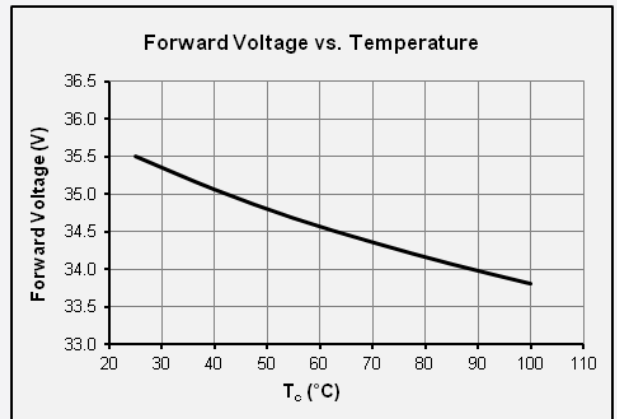
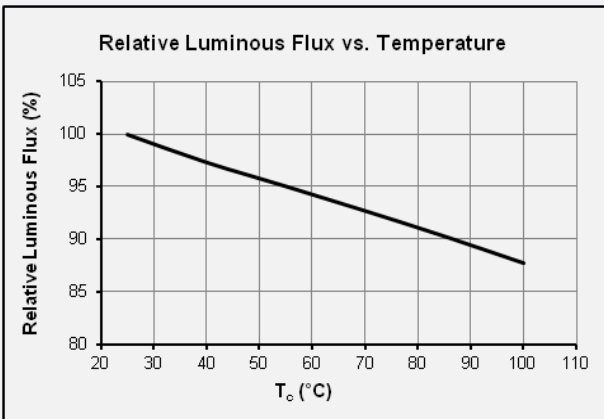

90 CRI

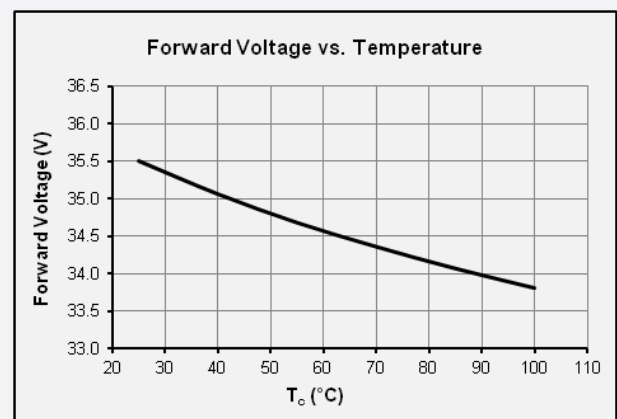
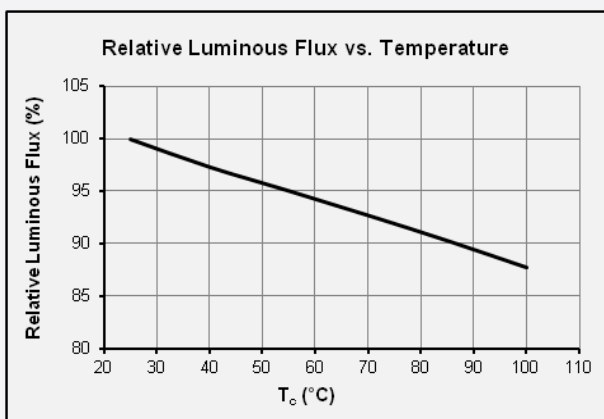

d) Color Shift Characteristics

$T_c = 25\text{ }^\circ\text{C}$

$I_F = 1080\text{ mA}$

80 CRI

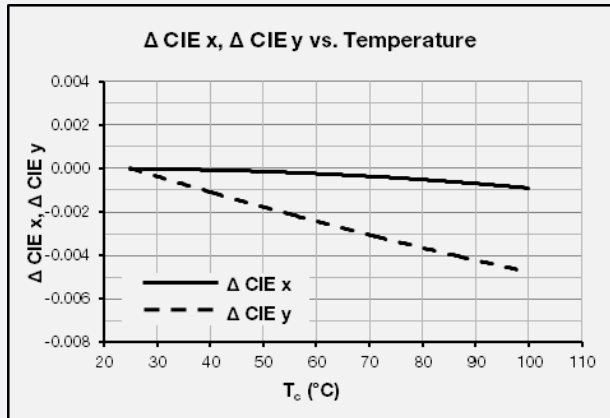
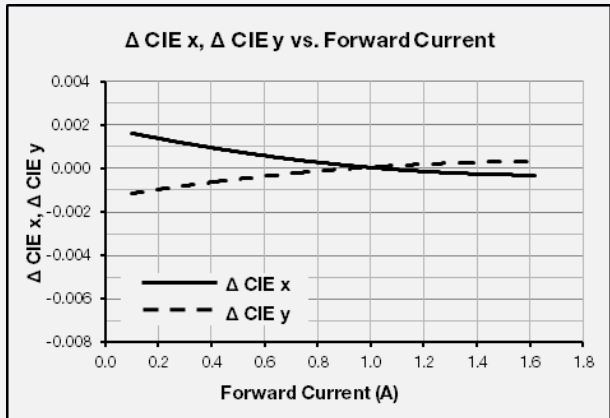

90 CRI

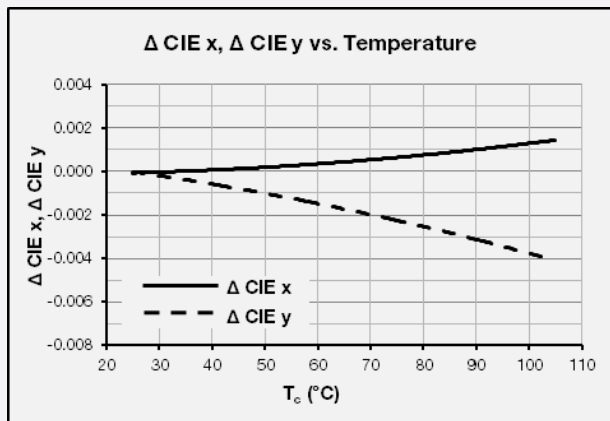
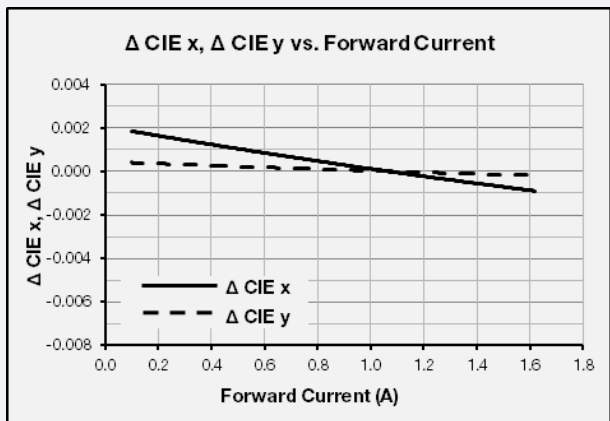

e) Derating Curve

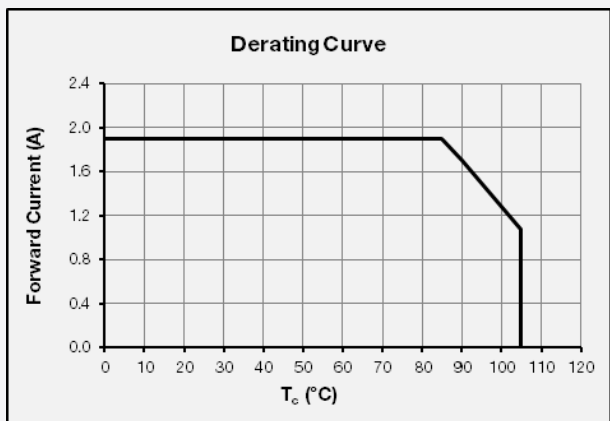

f) Beam Angle Characteristics ($I_F = 1080 \text{ mA}$, $T_c = 25 \text{ }^\circ\text{C}$)

80 CRI

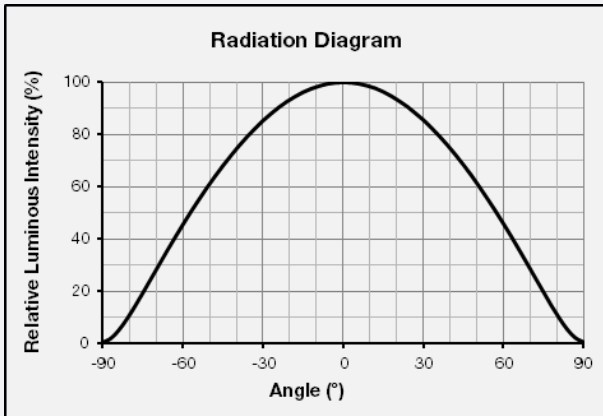

90 CRI

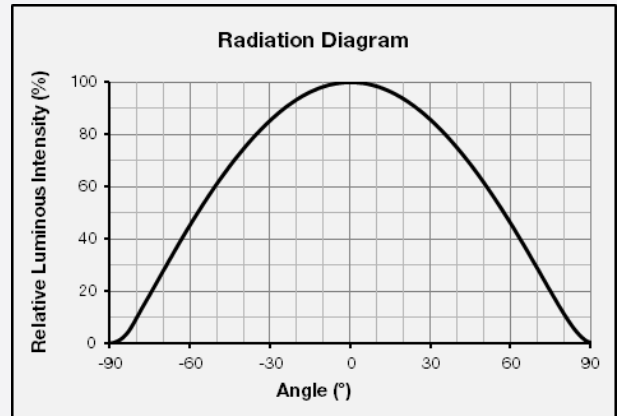

4. Outline Drawing & Dimension

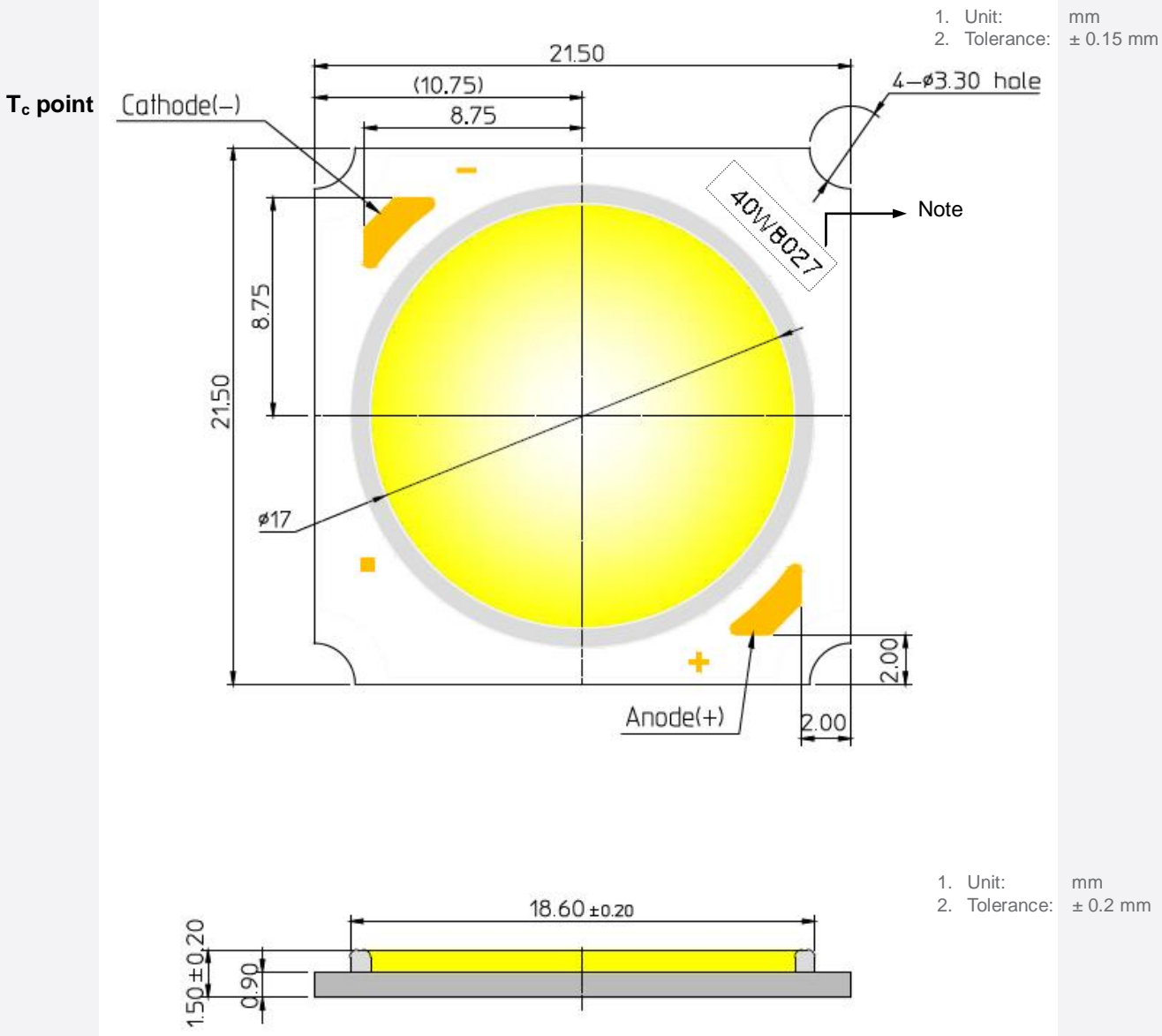

Item	Dimension	Tolerance	Unit
Length	21.50	±0.15	mm
Width	21.50	±0.15	mm
Height	1.50	±0.20	mm
Light Emitting Surface (LES) Diameter	17	±0.15	mm

Note: Denoted product information above is only an example
(40W8027 : 40W, CRI80+, 2700K)



5. Reliability Test Items & Conditions

a) Test Items

Test Item	Test Condition	Test Hour / Cycle
Room Temperature Life Test	25 °C, I _F = max	1000 h
High Temperature Humidity Life Test	85 °C, 85 % RH, DC Derating, I _F = max	1000 h
High Temperature Life Test	105 °C, DC Derating, I _F = max	1000 h
Low Temperature Life Test	-40 °C, DC 1900 mA	1000 h
High Temperature Storage	120 °C	1000 h
Low Temperature Storage	-40 °C	1000 h
Thermal Shock	-45 °C / 15 min ↔ 125 °C / 15 min temperature change in 5 min	200 cycles
Temperature Cycle On/Off Test	-40 °C / 85 °C each 20 min, 100 min transfer power on/off each 5 min, DC 1080 mA	100 cycles
Temperature Humidity Storage Test	-10 °C ↔ 25 °C, 95 % RH ↔ 85 °C, 95 % RH (24 h / cycle)	100 cycles
ESD (HBM)	R ₁ : 10 MΩ R ₂ : 1.5 kΩ C: 100 pF V: ±2 kV	5 times
ESD (MM)	R ₁ : 10 MΩ R ₂ : 0 kΩ C: 200 pF V: ±0.5 kV	5 times
Vibration Test	20 ~ 80 Hz (displacement: 0.06 inch, max. 20 g) 80 ~ 2 kHz (max. 20 g) min. frequency ↔ max. frequency 4 min transfer	4 times
Mechanical Shock Test	1500 g, 0.5 ms each of the 6 surfaces (3 axis x 2 sides)	5 times
Salt Spray Test	35 °C, 5 % salt water 8 h spray, 16 h dwell	2 cycles

b) Criteria for Judging the Damage

Item	Symbol	Test Condition (T _c = 25 °C)	Limit	
			Min.	Max.
Forward Voltage	V _F	I _F = 1080 mA	L.S.L. * 0.9	U.S.L. * 1.1
Luminous Flux	Φ _v	I _F = 1080 mA	L.S.L. * 0.7	U.S.L. * 1.3

6. Label Structure

a) Label Structure

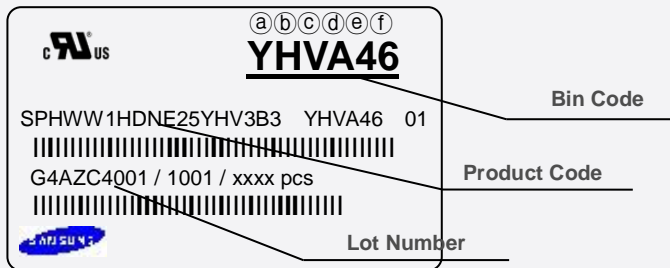

Note: Denoted bin code and product code above is only an example (see description on page 5)

Bin Code:

- ⒶⒷ: Forward Voltage bin (refer to page 11)
- ⒸⒹ: Chromaticity bin (refer to page 9-10)
- ⒺⒻ: Luminous Flux bin (refer to page 6)

b) Lot Number

The lot number is composed of the following characters:

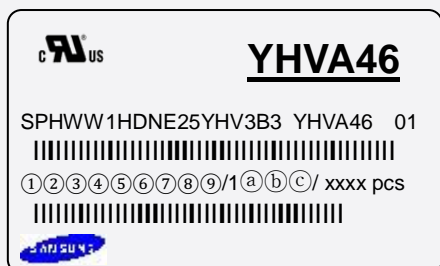

① ③④⑤⑥⑦⑧⑨ / 1ⒶⒷⒸ / xxxx pcs

- ① : Production site (S: Giheung, Korea, G: Tianjin, China)
- ② : 4 (LED)
- ③ : Product state (A: Normal, B: Bulk, C: First Production, R: Reproduction, S: Sample)
- ④ : Year (Z: 2015, A: 2016, B: 2017...)
- ⑤ : Month (1~9, A, B, C)
- ⑥⑦⑧⑨ : Day (1~9, A, B~V)
- ⒶⒷⒸ : Product serial number (001 ~ 999)

7. Packing Structure

Packing material	Max. quantity in pcs of COB	Dimension (mm)			
		Length	Width	Height	Tolerance
Tray	30	260	190	11.5	1.0
Anti-static Bag	150 (6 trays)	387	350	-	10
Box	1,050 (7 anti-static bag)	270	200	255	10

a) Packing Structure



b) Tray

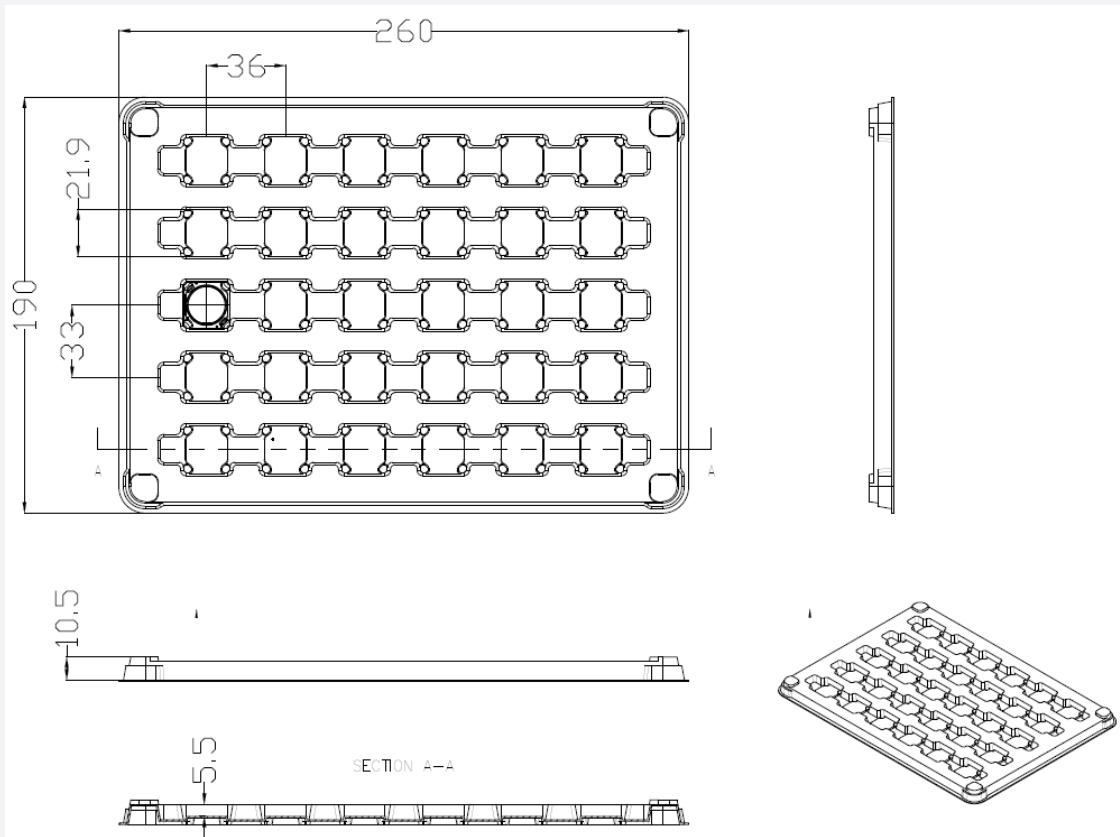

c) Anti-static Bag

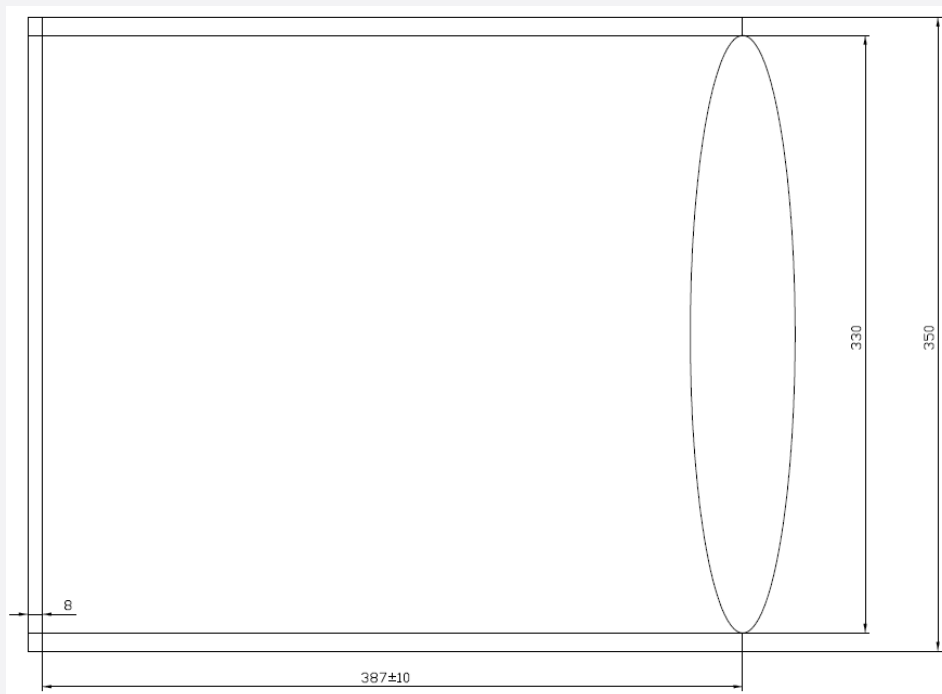

8. Precautions in Handling & Use

- 1) This device should not be used in any type of fluid such as water, oil, organic solvent, etc. When cleaning is required, IPA is recommended as the cleaning agent. Some solvent-based cleaning agent may damage the silicone resins used in the device.
- 2) LEDs must be stored in a clean environment. If the LEDs are to be stored for three months or more after being shipped from Samsung, they should be packed with a nitrogen-filled container (shelf life of sealed bags is 12 months at temperature 0~40 °C, 0~90 % RH).
- 3) After storage bag is opened, device subjected to soldering, solder reflow, or other high temperature processes must be:
 - a. Mounted within 672 hours (28 days) at an assembly line with a condition of no more than 30 °C / 60 % RH, or
 - b. Stored at <10 % RH
- 4) Repack unused products with anti-moisture packing, fold to close any opening and then store in a dry place.
- 5) Devices require baking before mounting, if humidity card reading is >60 % at 23 ± 5 °C.
- 6) Devices must be baked for 1 hour at 60 ± 5 °C, if baking is required.
- 7) The LEDs are sensitive to the static electricity and surge current. It is recommended to use a wrist band or anti-electrostatic glove when handling the LEDs. If voltage exceeding the absolute maximum rating is applied to LEDs, it may cause damage or even destruction to LED devices. Damaged LEDs may show some unusual characteristics such as increase in leakage current, lowered turn-on voltage, or abnormal lighting of LEDs at low current.
- 8) In case of driving the LC040B around the extremely low current level, chips might exhibit different brightness due to the variation in I-V characteristics of each one. This is normal and does not adversely affect the performance of product.
- 9) VOCs (Volatile Organic Compounds) can be generated from adhesives, flux, hardener or organic additives used in luminaires (fixtures). Transparent LED silicone encapsulant is permeable to those chemicals and they may lead to a discoloration of encapsulant when they exposed to heat or light. This phenomenon can cause a significant loss of light emitted (output) from the luminaires. In order to prevent these problems, we recommend users to know the physical properties of materials used in luminaires and they must be carefully selected.
- 10) The resin area is very sensitive, please do not handle, press, touch, rub, clean, or pick by with tweezers on it. Instead, please pick at the handling area as indicated below.

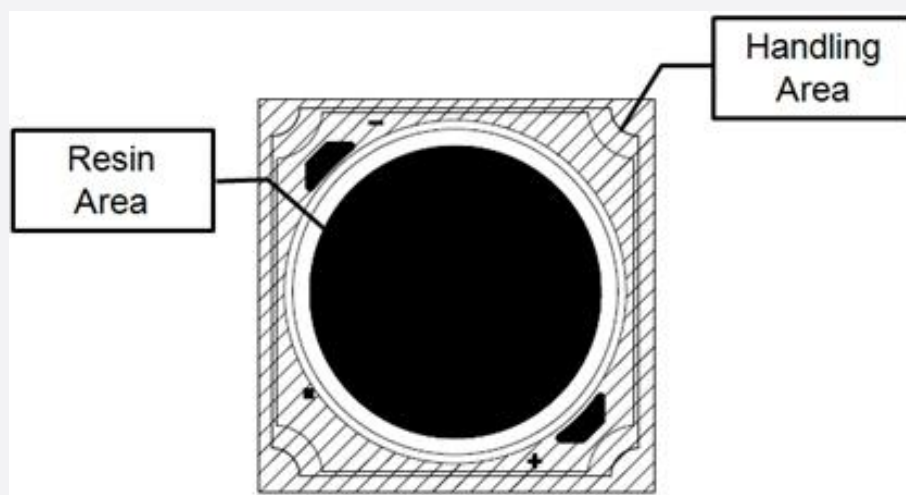

Legal and additional information.

[About Samsung Electronics Co., Ltd.](#)

Samsung Electronics Co., Ltd. inspires the world and shapes the future with transformative ideas and technologies, redefining the worlds of TVs, smartphones, wearable devices, tablets, cameras, digital appliances, printers, medical equipment, network systems and semiconductors.

We are also leading in the Internet of Things space through, among others, our Digital Health and Smart Home initiatives. We employ 307,000 people across 84 countries. To discover more, please visit our official website at www.samsung.com and our official blog at global.samsungtomorrow.com.

Copyright © 2015 Samsung Electronics Co., Ltd. All rights reserved.

Samsung is a registered trademark of Samsung Electronics Co., Ltd.

Specifications and designs are subject to change without notice. Non-metric weights and measurements are approximate. All data were deemed correct at time of creation. Samsung is not liable for errors or omissions. All brand, product, service names and logos are trademarks and/or registered trademarks of their respective owners and are hereby recognized and acknowledged.

Samsung Electronics Co., Ltd.

95, Samsung 2-ro

Giheung-gu

Yongin-si, Gyeonggi-do, 446-711

KOREA

www.samsungled.com



Looking for pricing, stock, or lifecycle information?

Click below to explore more details on WIN SOURCE:

- ⊖ [View SPHWW1HDNE25YHW3B3 on WIN SOURCE](#)
- ⊖ [Samsung Information](#)

Optimize Your Supply Chain with WIN SOURCE Solutions

- ✓ Global Sourcing Solution
- ✓ Obsolete Management
- ✓ Cost Control Management
- ✓ Shortage Management
- ✓ Alternative Solution
- ✓ Excess Inventory Management