

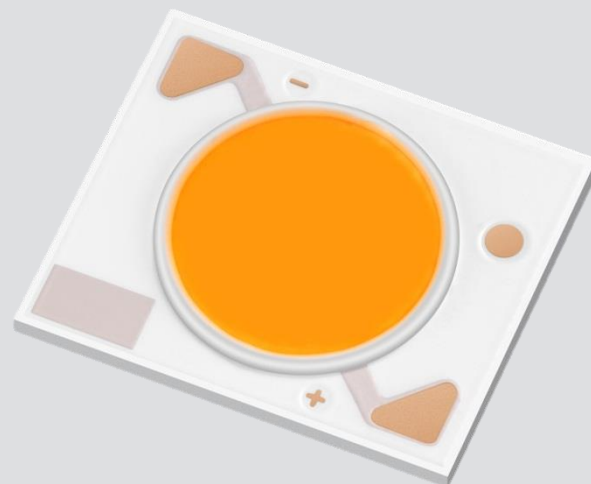

**THE DATASHEET OF
SPHWH2HDNE07YHV2C1**



High Voltage LED Series Chip on Board - Small LES COB line-up - LCo40C



Small LES COBs are well-suited for compact spot light system

Features & Benefits

- Suitable for luminaires with narrow beam angle such as shop lighting
- Maximize Center Beam Candle Power(CBCP)
- Reduce lighting system cost with smaller optical component
- High reliability without wire-bonding



Applications

- Spotlight / Downlight
- LED Retrofit Bulbs

1. Characteristics

a) Absolute Maximum Rating

Item	Symbol	Rating	Unit
Ambient / Operating Temperature	T_a	-40 ~ +105	°C
Storage Temperature	T_{stg}	-40 ~ +120	°C
Case Temperature	T_c	105	°C
LED Junction Temperature	T_j	140	°C
Forward Current	I_F	1.62	A
Minimum Current	I_{F_min}	40	mA
ESD (HBM)	-	±2	kV

Notes:

- 1) Refer to 4. Outline Drawing & Dimension for T_c point.
- 2) Refer to the Derating curve for proper driving current that maintained below Maximum junction temperature.

b) Electro-optical Characteristics ($I_F = 1.08$ A, $T_J = 85$ °C)

Item	Unit	Rank	Min.	Typ.	Max.
Forward Voltage (V_F) *1, *2	V	-	32.5	34.5	38.5
Color Rendering Index (R_a) *1, *2		5	80	-	-
		7	90	-	-
Thermal Resistance (Junction to T_c point)	°C/W		-	1.1	1.4
Beam Angle	°		-	115	-

Notes:

- 1) The COB is tested in pulsed operating condition at rated test current (10 ms pulse width) and rated temperature ($T_J = T_C = 85$ °C).
- 2) Samsung maintains measurement tolerance of: Forward Voltage = ±5 %, CRI = ±1

2. Product Code Information

1	2	3	4	5	6	7	8	9	10	11	12	13	14	15	16	17	18
S	P	H	W	H	2	H	D	N	E	0	5	Y	H	V	3	C	1

Digit	PKG Information	Code	Specification						
1 2 3	Samsung Package High Power	SPH							
4 5	Color	WH	White						
6	Product Version	2	Version						
7 8	Form Factor	HD	COB						
9	Lens Type	N	No lens						
10	Internal Code	E	LC040C						
11	Chip Type	0	Minor version						
12	CRI Ra & Sorting Temperature	5	Min. 80						
		7	Min. 90						
13 14	Forward Voltage (V)	YH	32.5~38.5						
15	CCT (K)	W	2700 K						
		V	3000 K						
		U	3500 K						
		T	4000 K						
		R	5000 K						
		Q	5700 K						
16	MacAdam / ANSI	2	MacAdam 2-step						
		3	MacAdam 3-step						
		T	ANSI bin						
17 18	Luminous Flux	C1	Ra min.80	2700K	C4, B4, A4				
				3000K	D4, C4, B4				
				3500K	E4, D4, C4				
				4000K	E4, D4, C4				
				5000K	F4, E4, D4				
				5700K	F4, E4, D4				
			Ra min.90	2700K	K3, H3, G3				
				3000K	L3, K3, H3				
				3500K	A4, L3, K3				
				4000K	B4, A4, L3				

a) 40W Luminous Flux Characteristics ($I_F = 1.08 \text{ A}$)

CRI (R_a)	Lumen Flux		Sorting ¹⁾ @ $T_J = 85 \text{ }^\circ\text{C}$ (lm)		CCT					
	Min.	Rank	Min.	Max.	2700K	3000K	3500K	4000K	5000K	5700K
80		G	4	5710	6110					
		F	4	5340	5710					
		E	4	4990	5340					
		D	4	4660	4990					
		C	4	4360	4660					
		B	4	4070	4360					
		A	4	3810	4070					
		L	3	3560	3810					
		K	3	3320	3560					
		H	3	3110	3320					
		G	3	2900	3110					
		F	3	2710	2900					

CRI (R_a)	Lumen Flux		Sorting ¹⁾ @ $T_J = 85 \text{ }^\circ\text{C}$ (lm)		CCT				
	Min.	Rank	Min.	Max.	2700K	3000K	3500K	4000K	
90		F	4	5340	5710				
		E	4	4990	5340				
		D	4	4660	4990				
		C	4	4360	4660				
		B	4	4070	4360				
		A	4	3810	4070				
		L	3	3560	3810				
		K	3	3320	3560				
		H	3	3110	3320				
		G	3	2900	3110				
		F	3	2710	2900				

Notes:

- 1) The COB is tested in pulsed operating condition at rated test current (10 ms pulse width) and rated temperature ($T_J = T_C = 85 \text{ }^\circ\text{C}$).
- 2) Samsung maintains measurement tolerance of: Luminous flux = $\pm 7 \%$, CRI = ± 1

b) Binning Structure ($I_F = 1.08 \text{ A}$, $T_J = 85 \text{ }^\circ\text{C}$)

CRI (R_a) Min.	Nominal CCT (K)	Product Code	V_F Rank	Color Rank	Color Bin	Flux Rank	Flux (lm) Typ.	Flux Range (Φ_v , lm)			
								Flux Bin	Min.	Max.	
80	2700	SPHWH2HDNE05YHW2C1	YH	W2	WB	C1	4280	C 4	4360	4660	
								B 4	4070	4360	
								A 4	3810	4070	
		SPHWH2HDNE05YHW3C1						C 4	4360	4660	
								B 4	4070	4360	
								A 4	3810	4070	
	3000	SPHWH2HDNE05YHV2C1	YH	V2	VB	C1	4470	D 4	4660	4990	
								C 4	4360	4660	
								B 4	4070	4360	
		SPHWH2HDNE05YHV3C1						C 4	4360	4660	
								B 4	4070	4360	
								A 4	3810	4070	
	3500	SPHWH2HDNE05YHU2C1	YH	U2	UB	C1	4650	E 4	4990	5340	
								D 4	4660	4990	
								C 4	4360	4660	
		SPHWH2HDNE05YHU3C1						E 4	4990	5340	
								D 4	4660	4990	
								C 4	4360	4660	
	4000	SPHWH2HDNE05YHT2C1	YH	T2	TB	C1	4760	E 4	4990	5340	
								D 4	4660	4990	
								C 4	4360	4660	
		SPHWH2HDNE05YHT3C1						E 4	4990	5340	
								D 4	4660	4990	
								C 4	4360	4660	
5000	SPHWH2HDNE05YHR3C1	YH	R3	RA	C1	5030	F 4	5340	5710		
							E 4	4990	5340		
							D 4	4660	4990		
	SPHWH2HDNE05YHRTC1						F 4	5340	5710		
							E 4	4990	5340		
							D 4	4660	4990		
5700	SPHWH2HDNE05YHQTC1	YH	QT	QW, QX, QY, QZ	C1	5030	F 4	5340	5710		
							E 4	4990	5340		
							D 4	4660	4990		

b) Binning Structure ($I_F = 1.08 \text{ A}$, $T_J = 85 \text{ }^\circ\text{C}$)

CRI (R_a) Min.	Nominal CCT (K)	Product Code	V_F Rank	Color Rank	Color Bin	Flux Rank	Flux (lm) Typ.	Flux Range (Φ_v , lm)		
								Flux Bin	Min.	Max.
90	2700	SPHWH2HDNE07YHW2C1	YH	W2	WB	C1	3190	K 3	3320	3560
								H 3	3110	3320
								G 3	2900	3110
		SPHWH2HDNE07YHW3C1	YH	W3	WA, WB	C1	3190	K 3	3320	3560
								H 3	3110	3320
								G 3	2900	3110
	3000	SPHWH2HDNE07YHV2C1	YH	V2	VB	C1	3470	L 3	3560	3810
								K 3	3320	3560
								H 3	3110	3320
		SPHWH2HDNE07YHV3C1	YH	V3	VA, VB	C1	3470	L 3	3560	3810
								K 3	3320	3560
								H 3	3110	3320
3500	SPHWH2HDNE07YHU2C1	YH	U2	UB	C1	3700	A 4	3810	4070	
							L 3	3560	3810	
							K 3	3320	3560	
	SPHWH2HDNE07YHU3C1	YH	U3	UA, UB	C1	3700	A 4	3810	4070	
							L 3	3560	3810	
							K 3	3320	3560	
4000	SPHWH2HDNE07YHT2C1	YH	T2	TB	C1	3900	B 4	4070	4360	
							A 4	3810	4070	
							L 3	3560	3810	
	SPHWH2HDNE07YHT3C1	YH	T3	TA, TB	C1	3900	B 4	4070	4360	
							A 4	3810	4070	
							L 3	3560	3810	

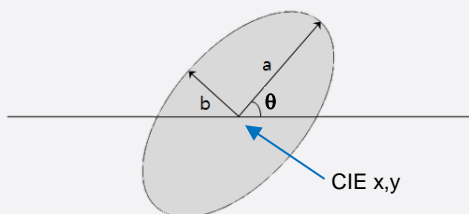
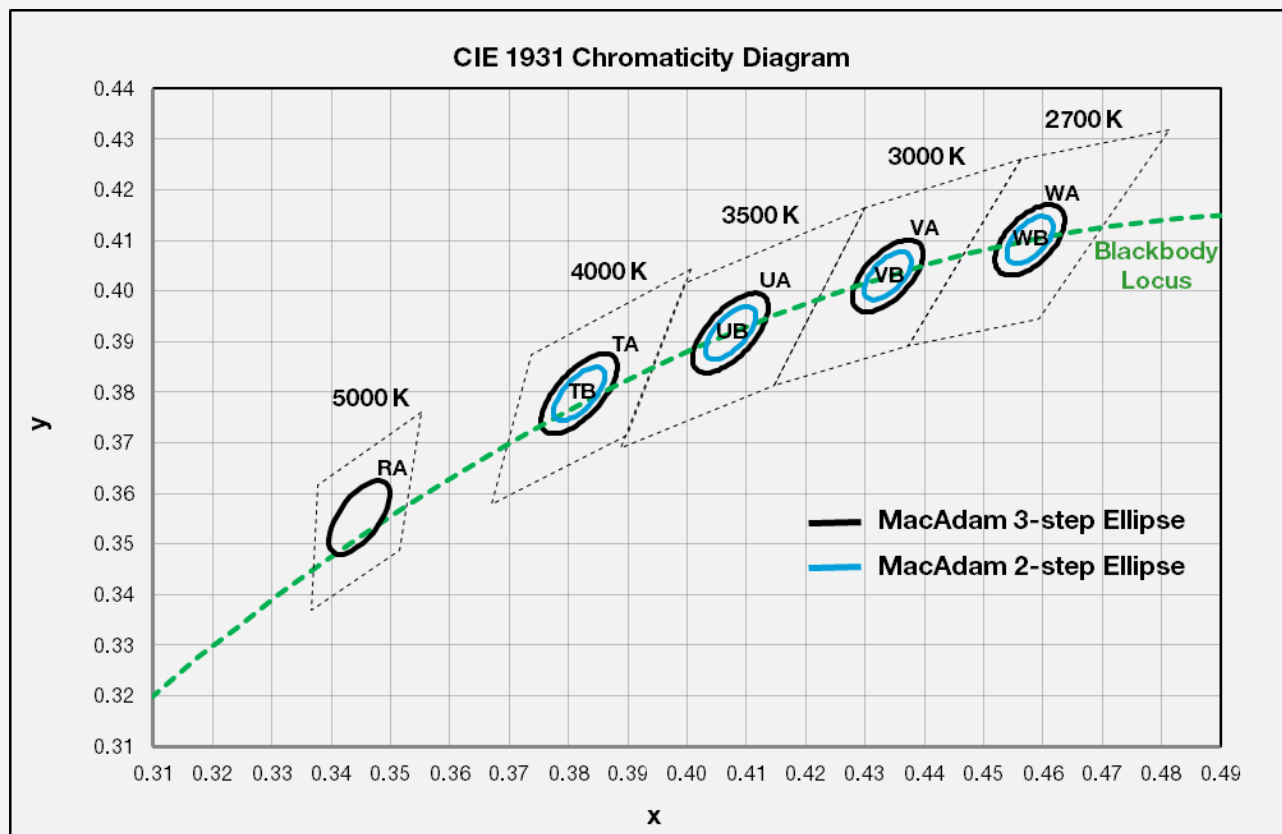
c) Chromaticity Region & Coordinates ($T_J = 85\text{ }^\circ\text{C}$)

MacAdam Ellipse (WA, WB)					
Step	CIE x	CIE y	θ	a	b
2-step	0.4578	0.4101	53.70	0.0054	0.0028
3-step	0.4578	0.4101	53.70	0.0081	0.0042

MacAdam Ellipse (VA, VB)					
Step	CIE x	CIE y	θ	a	b
2-step	0.4338	0.4030	53.22	0.0056	0.0027
3-step	0.4338	0.4030	53.22	0.0083	0.0041

MacAdam Ellipse (UA, UB)					
Step	CIE x	CIE y	θ	a	b
2-step	0.4073	0.3917	54.00	0.0062	0.0028
3-step	0.4073	0.3917	54.00	0.0093	0.0041

MacAdam Ellipse (TA, TB)					
Step	CIE x	CIE y	θ	a	b
2-step	0.3818	0.3797	53.72	0.0063	0.0027
3-step	0.3818	0.3797	53.72	0.0094	0.0040

MacAdam Ellipse (RA)					
Step	CIE x	CIE y	θ	a	b
3-step	0.3447	0.3553	59.62	0.0082	0.0035

Note : Samsung maintains measurement tolerance of: $C_x, C_y = \pm 0.005$

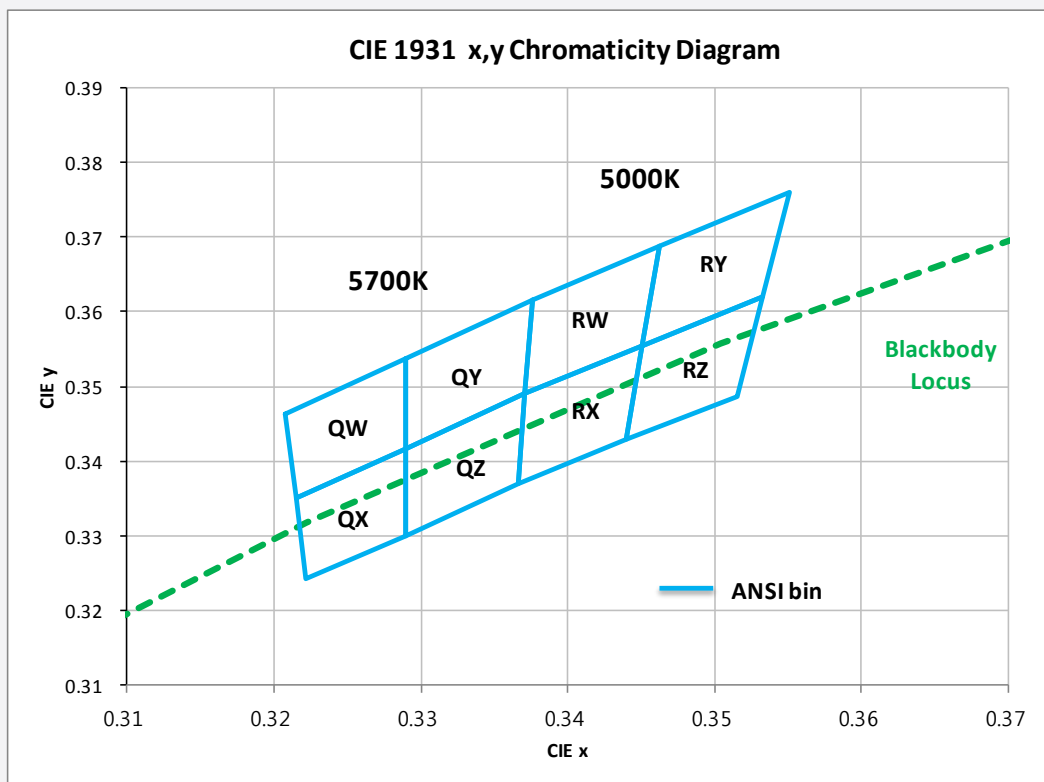
d) Chromaticity Region & Coordinates ($T_J = 85^\circ\text{C}$)

Region	CIE x	CIE y	Region	CIE x	CIE y
R rank (5000 K)					
RW	0.3376	0.3616	RY	0.3463	0.3687
	0.3463	0.3687		0.3551	0.3760
	0.3451	0.3554		0.3533	0.3620
	0.3371	0.3490		0.3451	0.3554
RX	0.3371	0.3490	RZ	0.3451	0.3554
	0.3451	0.3554		0.3533	0.3620
	0.3440	0.3428		0.3515	0.3487
	0.3366	0.3369		0.3440	0.3428

Region	CIE x	CIE y	Region	CIE x	CIE y
Q rank (5700 K)					
QW	0.3207	0.3462	QY	0.3290	0.3538
	0.3290	0.3538		0.3376	0.3616
	0.3290	0.3417		0.3371	0.3490
	0.3215	0.3350		0.3290	0.3417
QX	0.3215	0.3350	QZ	0.3290	0.3417
	0.3290	0.3417		0.3371	0.3490
	0.3290	0.3300		0.3366	0.3369
	0.3222	0.3243		0.3290	0.3300

Note : Samsung maintains measurement tolerance of: $C_x, C_y = \pm 0.005$

3. Typical Characteristics Graphs

a) Spectrum Distribution ($I_F = 1.08 \text{ A}$, $T_J = 85 \text{ }^\circ\text{C}$)

CRI Ra 80+

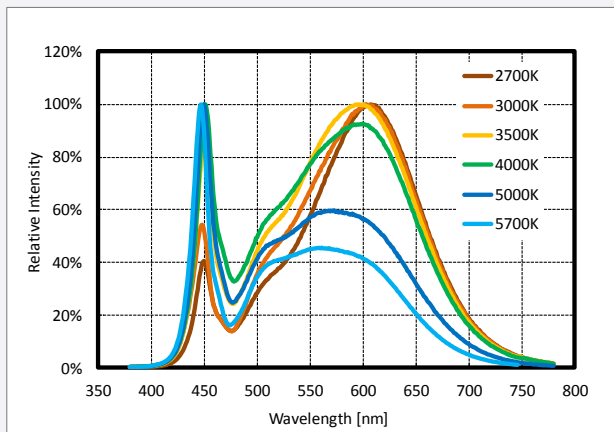

CRI Ra 90+

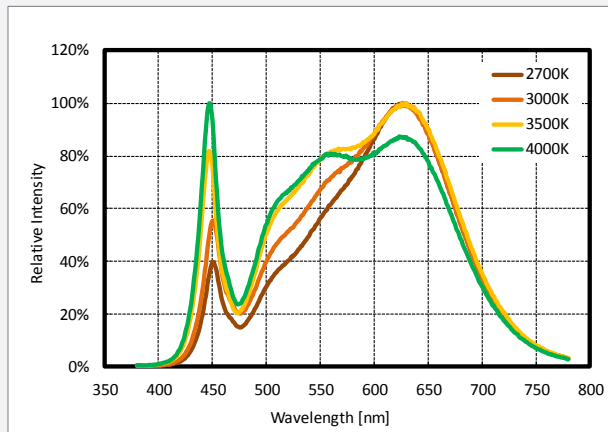

b) Forward Current Characteristics ($T_J = 85 \text{ }^\circ\text{C}$)

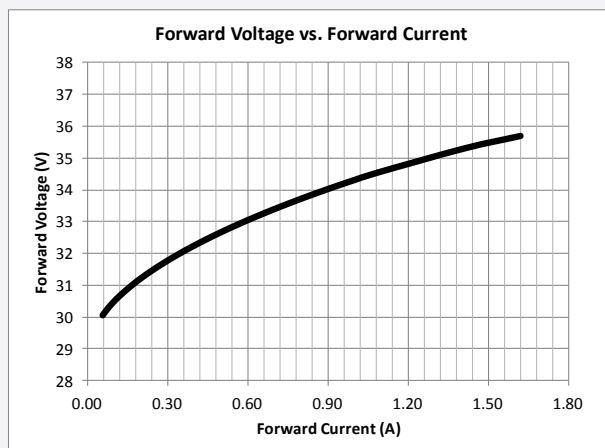
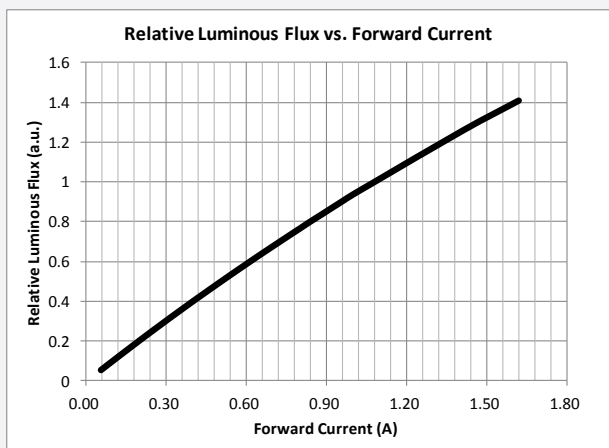

c) Temperature Characteristics ($I_F = 1.08 \text{ A}$)

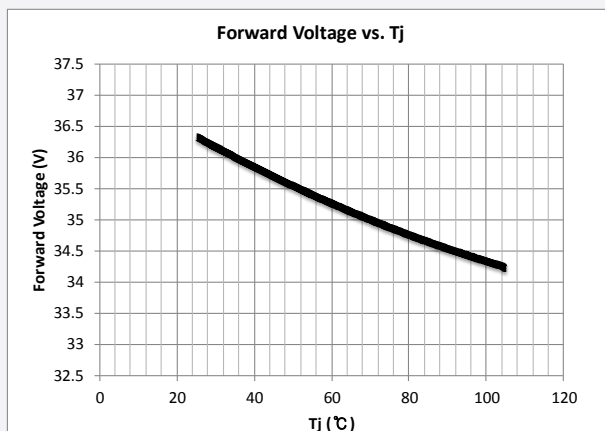
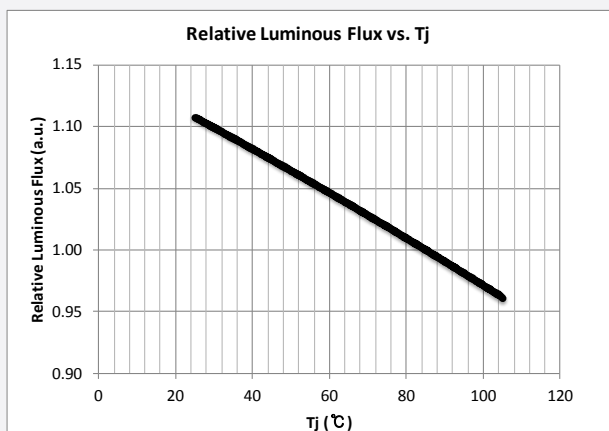

d) Color Shift Characteristics

$T_J = 85^\circ\text{C}$

$I_F = 1.08\text{A}$

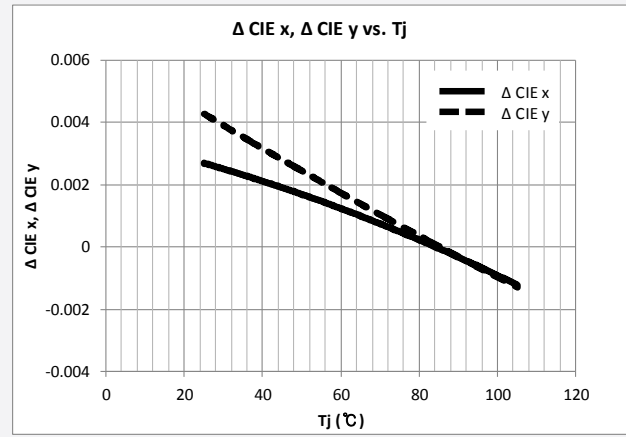
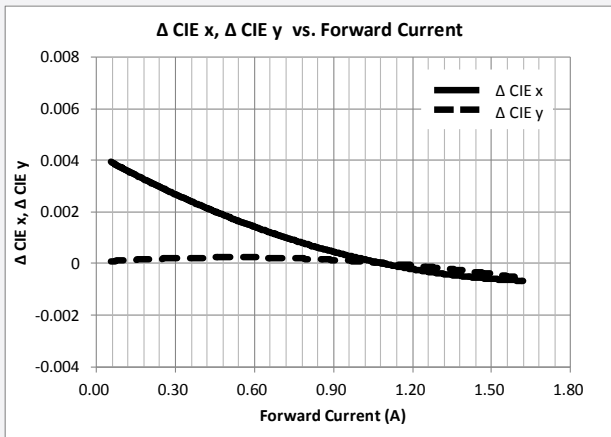

e) Derating Characteristics

Case temperature vs. Allowable Forward Current

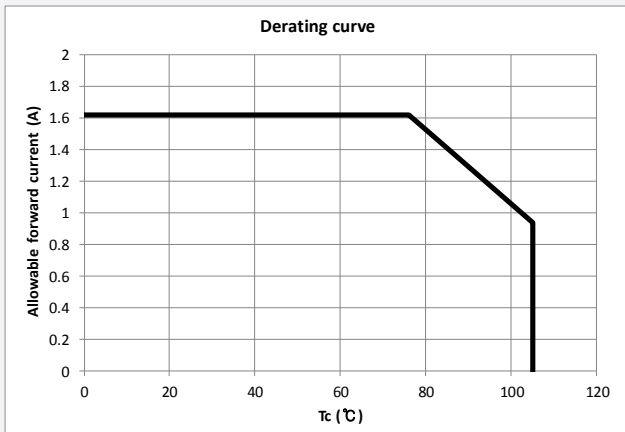

f) Beam Angle Characteristics ($I_F = 1.08\text{ A}$, $T_a = 25^\circ\text{C}$)

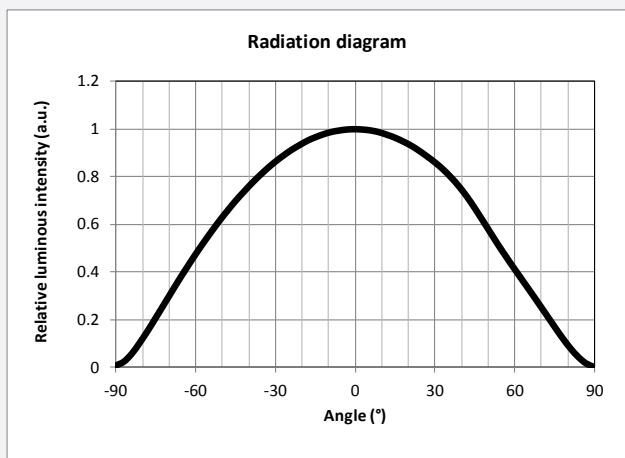

4. Outline Drawing & Dimension

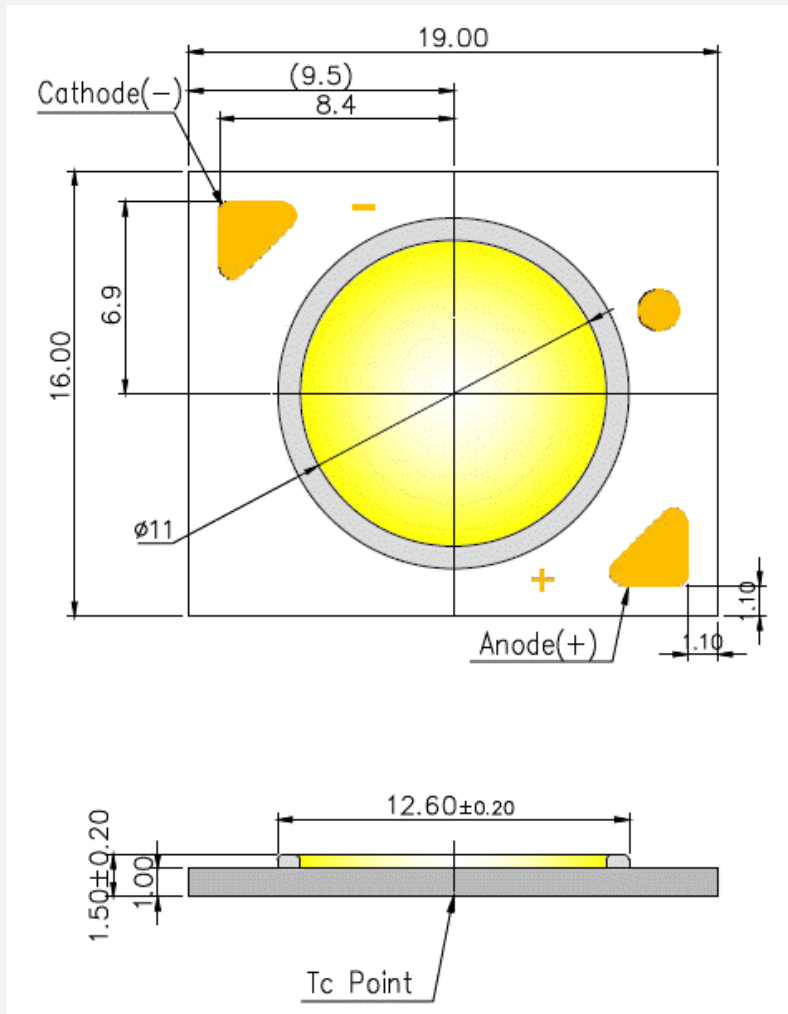

- 1. Unit: mm
- 2. Tolerance: ± 0.20 mm

- 1. Unit: mm
- 2. Tolerance: ± 0.2 mm

Note : Tc point : The Center of the back side of substrate.

Item	Dimension	Tolerance	Unit
Length	19.00	± 0.20	mm
Width	16.00	± 0.20	mm
Height	1.50	± 0.20	mm
Light Emitting Surface (LES) Diameter	11	± 0.15	mm

5. Reliability Test Items & Conditions

a) Test Items

Test Item	Test Condition	Test Hour / Cycle
High Temperature Humidity Life Test	60 °C, 90 % RH,, DC Derating, I_F	1000 h
High Temperature Life Test	85 °C, DC Derating, I_F	1000 h
Low Temperature Life Test	-40 °C, DC I_F Max	1000 h
Pulsed Operating Life Test	55 °C, Pulse width 100 μ s, duty cycle 3 %	1000 h
High Temperature Storage	120 °C	1000 h
Low Temperature Storage	-40 °C	1000 h
Temperature Humidity Storage	60 °C, 90% RH	1000h
Thermal Cycle	-45 °C / 15 min \leftrightarrow 125 °C / 15 min temperature change in 5 min	800 cycles
Temperature Cycle On/Off Test	-40 °C / 85 °C each 20 min, 30 min transfer power on/off each 5 min, DC Derating, I_F = max	100 cycles
ESD (HBM)	R_1 : 10 M Ω R_2 : 1.5 k Ω C: 100 pF V: \pm 2 kV	5 times
ESD (MM)	R_1 : 10 M Ω R_2 : 0 k Ω C: 200 pF V: \pm 0.2 kV	5 times
Vibration Test	20 ~ 80 Hz (displacement: 0.06 inch, max. 20 g) 80 ~ 2 kHz (max. 20 g) min. frequency \leftrightarrow max. frequency 4 min transfer	4 times
Mechanical Shock Test	1500 g, 0.5 ms each of the 6 surfaces (3 axis x 2 sides)	5 times
Sulfur Resistance	25 °C, 75%, H2S 15 ppm	504h

b) Criteria for Judging the Damage

Item	Symbol	Test Condition ($T_c = 25$ °C)	Limit	
			Min.	Max.
Forward Voltage	V_F	$I_F = 1.08$ A	L.S.L. * 0.9	U.S.L. * 1.1
Luminous Flux	Φ_v	$I_F = 1.08$ A	L.S.L * 0.7	U.S.L * 1.3

6. Label Structure

a) Label Structure

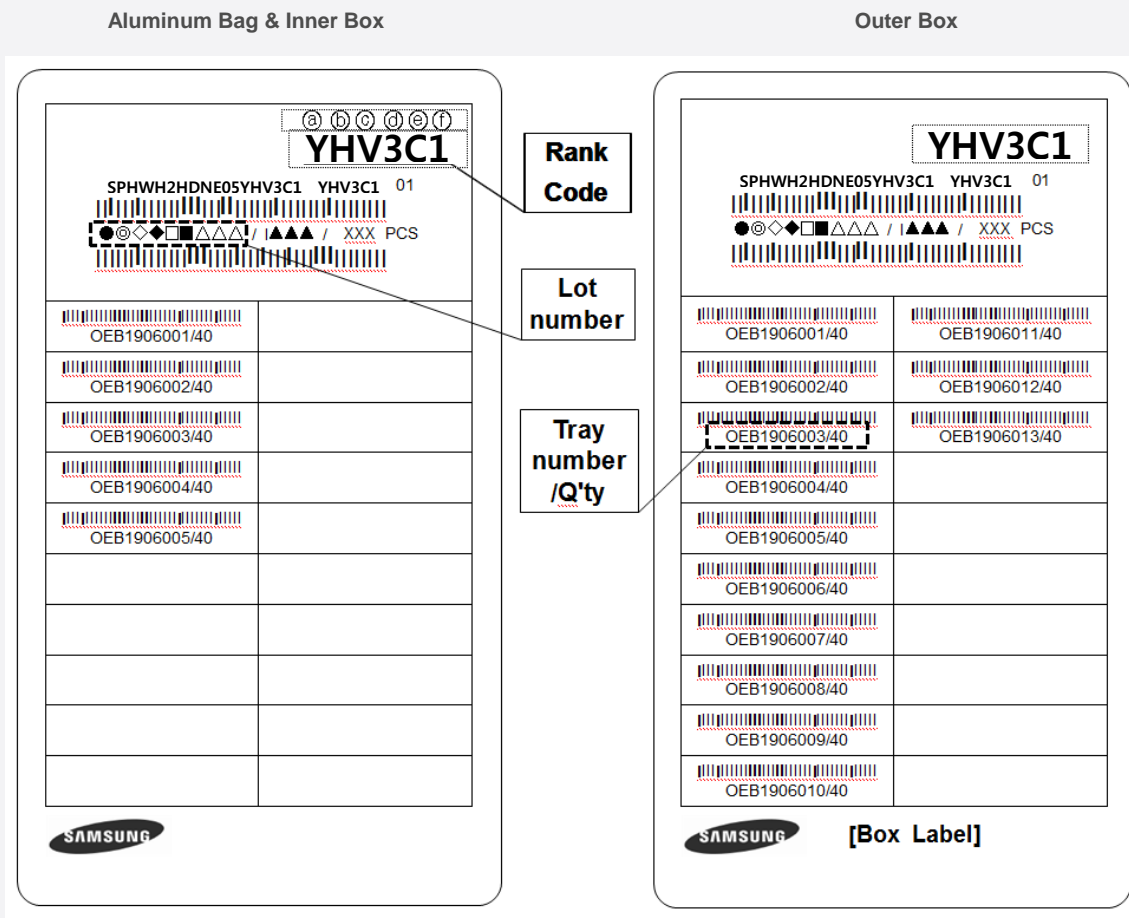

Note: Denoted rank code and product code above is only an example (see description on page 6)

Rank Code:

- ⒶⒷ: Forward Voltage rank (refer to page 3)
- ⒸⒹ: Chromaticity bin (refer to page 5-6)
- ⒺⒻ: Luminous Flux bin (refer to page 4)

b) Lot Number

The lot number is composed of the following characters:

●◎◇◆□■△△△ / 1▲▲▲ / xxx PCS

- : Production site (S: Giheung, Korea, G: Tianjin, China)
- ◎ : L (LED)
- ◇ : Product state (A: Normal, B: Bulk, C: First Production, R: Reproduction, S: Sample)
- ◆ : Year (Y: 2014, Z: 2015, A: 2016, ...)
- : Month (1~9, A, B, C)
- : Day (1~9, A, B~V)
- △△△ : Product serial number (001 ~ 009)
- ▲▲▲ : Tray number (001 ~ 999)

7. Packing Structure

Packing material	Max. quantity in pcs of COB	Dimension (mm)			
		Length	Width	Height	Tolerance
Tray	55	322.6	135.9	11	0.25
Aluminum Bag	440 (8 trays)	450	230	-	10
PE Foam Pad	-	280	130	10	2
Inner Box	440 (1 aluminum bag)	338	148	55	2
Outer Box	1,760 (4 inner boxes)	351	308	120	5
Pallet	98,560 (56 outer boxes)	1000	1000	970	10

a) Packing Structure for 8 trays inside Aluminum Bag

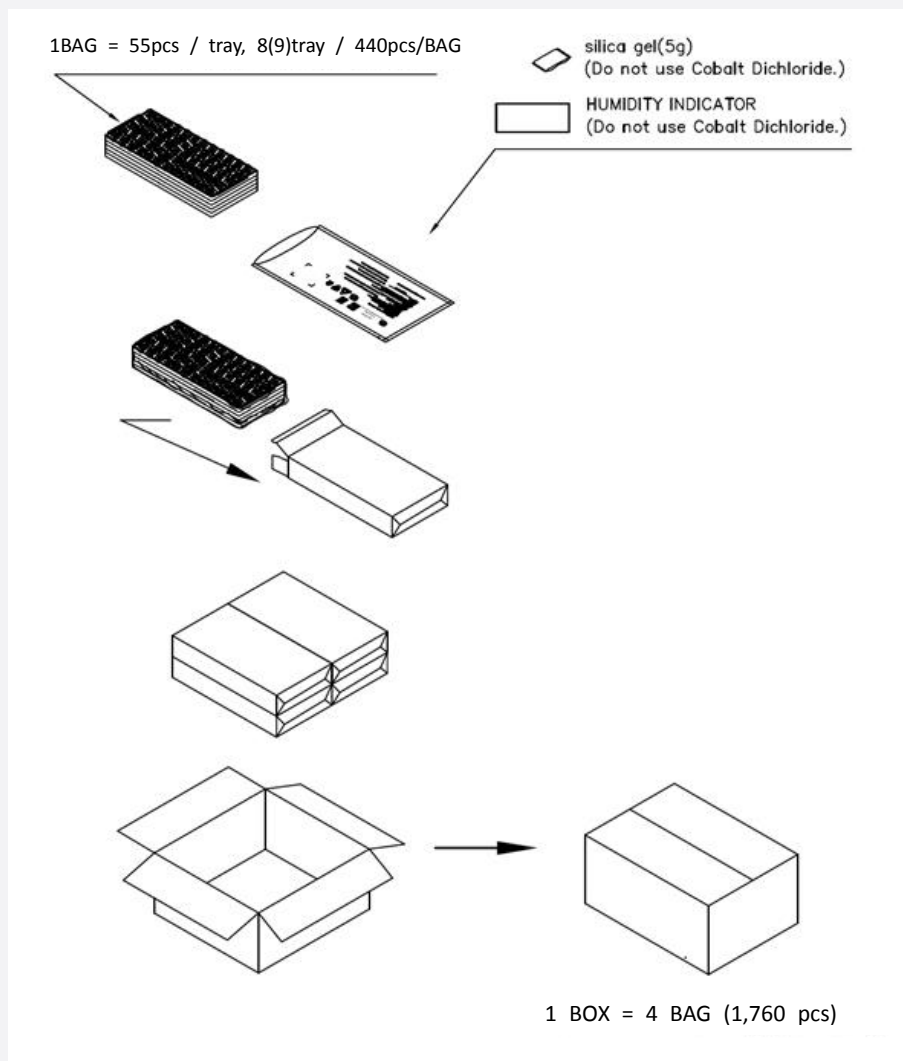

b) Packing Structure for <8 trays inside Aluminum Bag

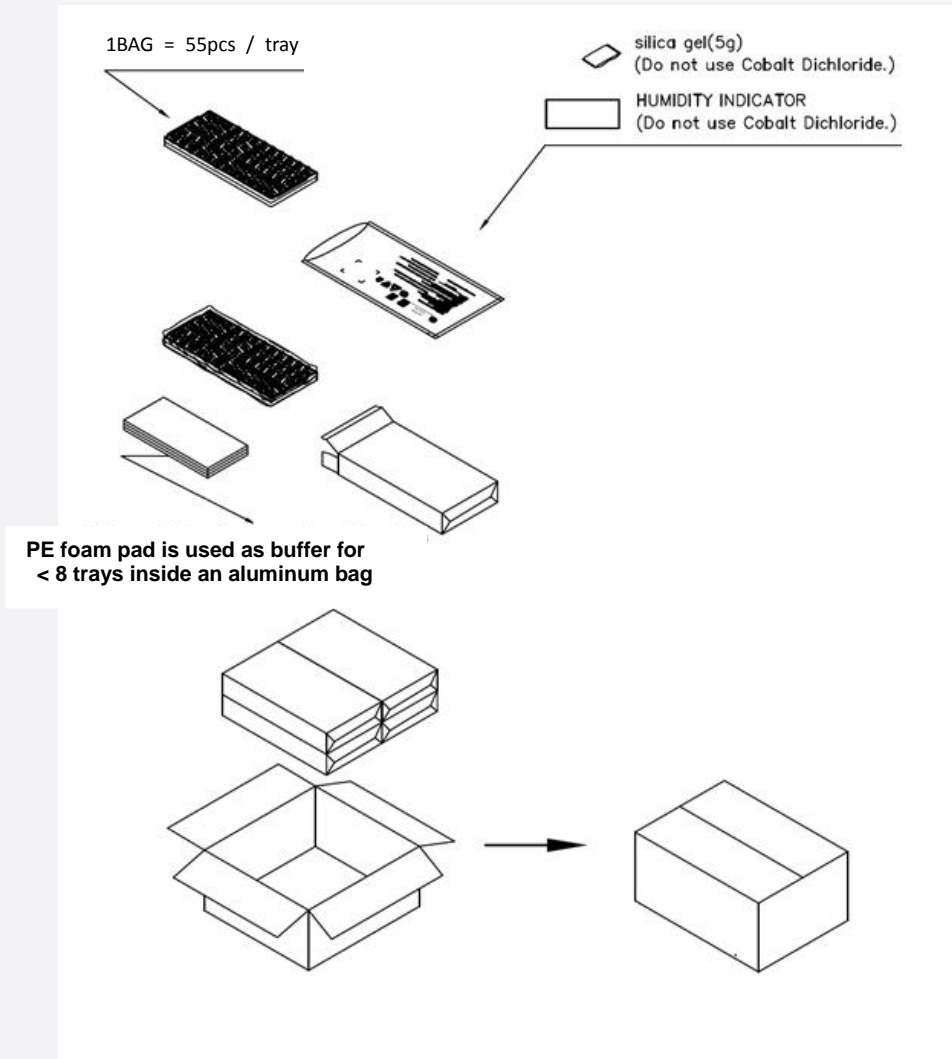

c) Tray

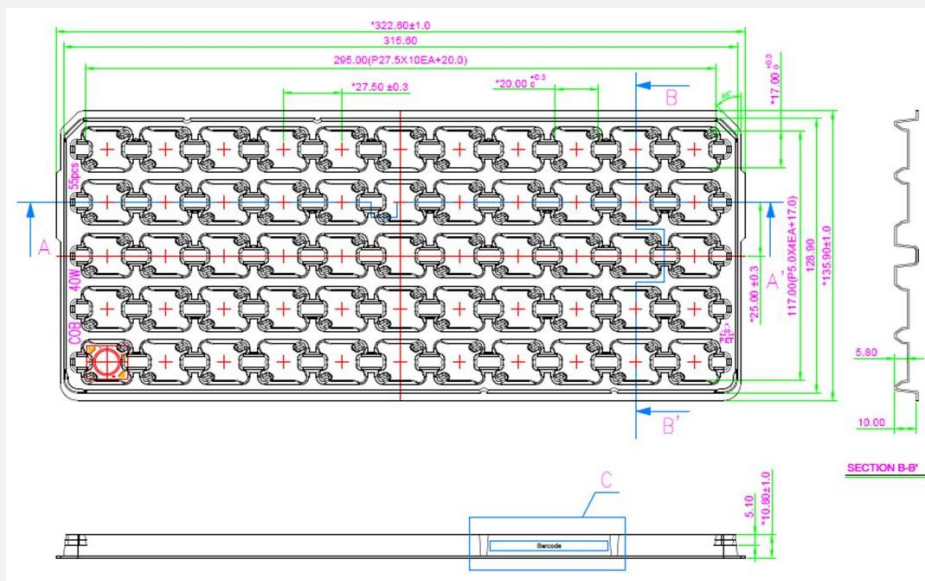

d) Aluminum Vinyl Packing Bag

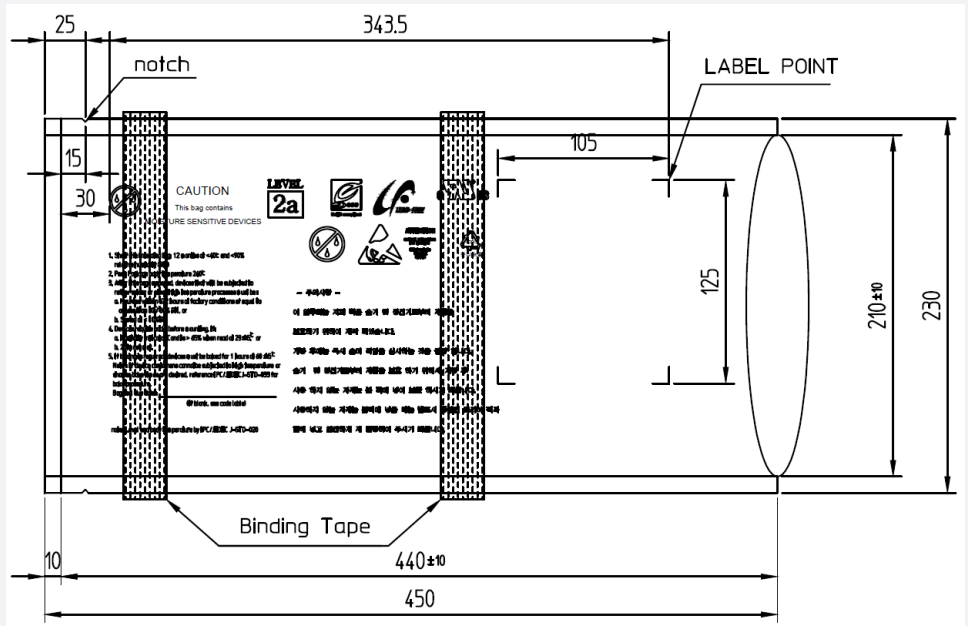

e) Silica Gel & Humidity Indicator Card inside Aluminum Vinyl Packing Bag

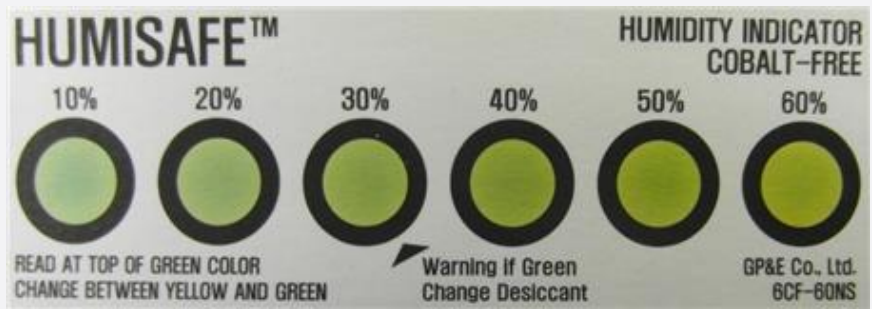

8. Precautions in Handling & Use

- 1) This device should not be used in any type of fluid such as water, oil, organic solvent, etc. When cleaning is required, IPA is recommended as the cleaning agent. Some solvent-based cleaning agent may damage the silicone resins used in the device.
- 2) LEDs must be stored in a clean environment. If the LEDs are to be stored for three months or more after being shipped from Samsung, they should be packed with a nitrogen-filled container (shelf life of sealed bags is 12 months at temperature 0~40 °C, 0~90 % RH).
- 3) After storage bag is opened, device subjected to soldering or other high temperature processes must be:
 - a. Mounted within 672 hours (28 days) at an assembly line with a condition of no more than 30 °C / 60 % RH, or
 - b. Stored at <10 % RH
- 4) Repack unused products with anti-moisture packing, fold to close any opening and then store in a dry place.
- 5) Devices require baking before mounting, if humidity card reading is >60 % at 23 ± 5 °C.
- 6) Devices must be baked for 1 hour at 60 ± 5 °C, if baking is required.
- 7) The LEDs are sensitive to the static electricity and surge current. It is recommended to use a wrist band or anti-electrostatic glove when handling the LEDs. If voltage exceeding the absolute maximum rating is applied to LEDs, it may cause damage or even destruction to LED devices. Damaged LEDs may show some unusual characteristics such as increase in leakage current, lowered turn-on voltage, or abnormal lighting of LEDs at low current.
- 8) The thermal management is one of the most critical factors for the LED lighting system. Especially the LED junction temperature should not exceed the absolute maximum rating while operation of LED lighting system.
For more information, please refer to Application Note 'Mechanical & Thermal Guide for COB'.
- 9) In case of driving the LC040C around the minimum current level (I_{f_min}), chips might exhibit different brightness due to the variation in I-V characteristics of each one. This is normal and does not adversely affect the performance of product.
- 10) VOCs (Volatile Organic Compounds) can be generated from adhesives, flux, hardener or organic additives used in luminaires (fixtures). Transparent LED silicone encapsulant is permeable to those chemicals and they may lead to a discoloration of encapsulant when they exposed to heat or light. This phenomenon can cause a significant loss of light emitted (output) from the luminaires. In order to prevent these problems, we recommend users to know the physical properties of materials used in luminaires and they must be carefully selected.
- 11) The resin area is very sensitive, please do not handle, press, touch, rub, clean, or pick by with tweezers on it. Instead, please pick at the handling area as indicated below.

For more information, please refer to Application Note 'LED Handling Guide'.

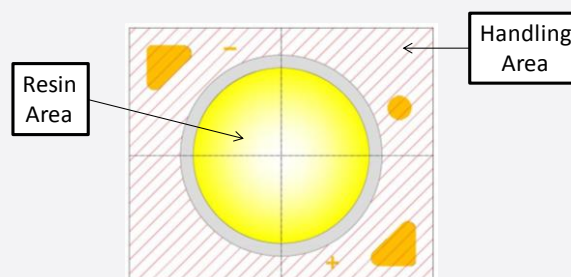

Legal and additional information.

[About Samsung Electronics Co., Ltd.](#)

Samsung Electronics Co., Ltd. inspires the world and shapes the future with transformative ideas and technologies, redefining the worlds of TVs, smartphones, wearable devices, tablets, cameras, digital appliances, printers, medical equipment, network systems and semiconductors.

We are also leading in the Internet of Things space through, among others, our Digital Health and Smart Home initiatives. We employ 307,000 people across 84 countries. To discover more, please visit our official website at www.samsung.com and our official blog at global.samsungtomorrow.com.

Copyright © 2015 Samsung Electronics Co., Ltd. All rights reserved.
Samsung is a registered trademark of Samsung Electronics Co., Ltd.
Specifications and designs are subject to change without notice. Non-metric weights and measurements are approximate. All data were deemed correct at time of creation. Samsung is not liable for errors or omissions. All brand, product, service names and logos are trademarks and/or registered trademarks of their respective owners and are hereby recognized and acknowledged.



Samsung Electronics Co., Ltd.
95, Samsung 2-ro
Giheung-gu
Yongin-si, Gyeonggi-do, 446-711
KOREA

www.samsungled.com



Looking for pricing, stock, or lifecycle information?

Click below to explore more details on WIN SOURCE:

-  [View SPHWH2HDNE07YHV2C1 on WIN SOURCE](#)
-  [Samsung Information](#)

Optimize Your Supply Chain with WIN SOURCE Solutions

-  Global Sourcing Solution
-  Obsolete Management
-  Cost Control Management
-  Shortage Management
-  Alternative Solution
-  Excess Inventory Management