



**THE DATASHEET OF
SI-B8U112560WW**



LED Module

LT-E562A

LT-E282A

LT-E072A



Features & Benefits

- Easy connection with re-workable poke-in connector
- Fit better to replace conventional T5, T8 fixture with narrow width
- Full Certifications

Applications

Indoor Lighting:

- Office / Retail/ Living space
- Area Panels, Troffer and Linear Pendants
- Channel and Cove lighting

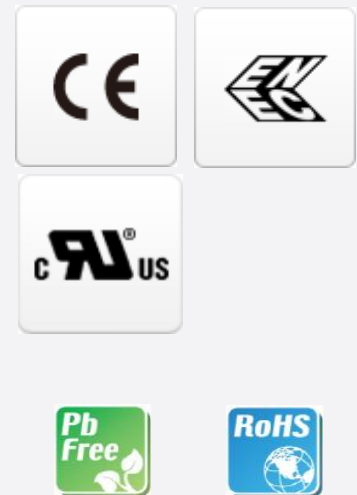

Table of Contents

1.	Product Code Information	-----	3
2.	Characteristics	-----	4
3.	Structure and Assembly	-----	6
4.	Certification and Declaration	-----	9
5.	Label Structure	-----	10
6.	Packing Structure	-----	12
7.	Precautions in Handling & Use	-----	13

1. Product Code Information

Model	Nominal CCT (K)	Product Code
LT-E072A	3000	SI-B8V021070WW
	3500	SI-B8U021070WW
	4000	SI-B8T021070WW
	5000	SI-B8R021070WW
LT-E282A	3000	SI-B8V061280WW
	3500	SI-B8U061280WW
	4000	SI-B8T061280WW
	5000	SI-B8R061280WW
LT-E562A	3000	SI-B8V112560WW
	3500	SI-B8U112560WW
	4000	SI-B8T112560WW
	5000	SI-B8R112560WW

2. Characteristics

Item	Rating	Unit	Remark
Rated Lifetime	>50,000	hour	L70B50 @ $t_p = 85\text{ }^\circ\text{C}$
Ingress Protection (IP)	no rating	-	
Ambient / Operating Temperature (t_{amb})	-20 ~ +50	$^\circ\text{C}$	
Storage Temperature	-30 ~ +80	$^\circ\text{C}$	

a) E072A

Item	Nom. CCT (K)	Rating			Unit	Remark
		Min	Typ.	Max		
Luminous Flux (Φ_v)	3000	215	235	255	lm	$I_f = 300\text{ mA}$ $t_p = 50\text{ }^\circ\text{C}$
	3500	220	240	260		
	4000	230	250	270		
	5000	235	255	275		
Luminous Efficacy	3000	114	124	135	lm/W	
	3500	116	126	138		
	4000	122	131	143		
	5000	124	134	146		
CCT	3000	2948	3040	3132	K	
	3500	3291	3409	3524		
	4000	3796	3948	4100		
	5000	4798	5050	5307		
Color Consistency (initial)	3000	-	3	-	MacAdam step	
	3500					
	4000					
	5000					
Color Rendering Index (Ra)		80	-	-	-	
Operating Current (I_f)		-	300	360	mA	-
Operating Voltage (V_f)		5.7	6.3	6.9	Vdc	$I_f = 300\text{ mA}$
Power Consumption		1.7	1.9	2.1	W	$t_p = 50\text{ }^\circ\text{C}$

b) E282A

Item	Nom. CCT (K)	Rating			Unit	Remark
		Min	Typ.	Max		
Luminous Flux (Φ_v)	3000	655	705	765	lm	$I_f = 300\text{ mA}$ $t_p = 50\text{ }^\circ\text{C}$
	3500	665	715	780		
	4000	690	745	810		
	5000	705	760	830		
Luminous Efficacy	3000	117	125	136	lm/W	

	3500	119	127	139		
	4000	123	132	144		
	5000	126	135	148		
CCT	3000	2938	3030	3122	K	
	3500	3302	3421	3538		
	4000	3828	3981	4136		
	5000	4809	5061	5319		
Color Consistency (initial)	3000	-	3	-	MacAdam step	
	3500					
	4000					
	5000					
Color Rendering Index (Ra)		80	-	-	-	
Operating Current (I _f)		-	300	360	mA	-
Operating Voltage (V _f)		16.8	18.7	20.6	Vdc	I _f = 300 mA
Power Consumption		5.0	5.6	6.2	W	t _p = 50 °C

c) E562A

Item	Nom. CCT (K)	Rating			Unit	Remark
		Min	Typ.	Max		
Luminous Flux (Φ _v)	3000	1310	1407	1535	lm	
	3500	1330	1429	1560		
	4000	1380	1487	1620		
	5000	1412	1518	1655		
Luminous Efficacy	3000	116	126	137	lm/W	I _f = 300 mA t _p = 50 °C
	3500	118	128	139		
	4000	123	134	144		
	5000	125	136	148		
CCT	3000	2957	3051	3143	K	
	3500	3321	3440	3559		
	4000	3806	3958	4109		
	5000	4788	5041	5296		
Color Consistency (initial)	3000	-	3	-	MacAdam step	
	3500					
	4000					
	5000					
Color Rendering Index (Ra)		80	-	-	-	
Operating Current (I _f)		-	300	360	mA	-
Operating Voltage (V _f)		33.7	37.4	41.1	Vdc	I _f = 300 mA
Power Consumption		10.1	11.2	12.3	W	t _p = 50 °C

Notes:

- 1) t_p: temperature at which performance is specified; measured at “Tc point”.

2) Samsung maintains a measurement tolerance of: Luminous flux: $\pm 7\%$, CRI: ± 3.0 , Voltage: $\pm 0.3\text{ V}$.

Item	Nominal*	Life**	Max***	Unit
Temperature	50 (t_p)	85 ($t_{p, 50}$)	90 (t_c)	°C

Notes:

- * Temperature used to specify performance of the module (t_p).
 - ** Rated maximum performance temperature at which lifetime is specified ($t_{p, 50}$).
 - *** Rated maximum temperature, highest permissible temperature to avoid safety risk (t_c).
- All temperatures are measured at the designated “Tc point” as indicated on the module.

3. Structure and Assembly

a) Appearance

E072A



E282A



E562A



b) Dimension

E072A

imension	Specification	Tolerance	Unit
Module Length	70.0	± 0.4	mm
Module Width	24.0	± 0.3	mm
Module Height	5.8	± 0.3	mm
PCB Thickness	1.6	± 0.16	mm
Module Weight	6.0	± 0.3	g

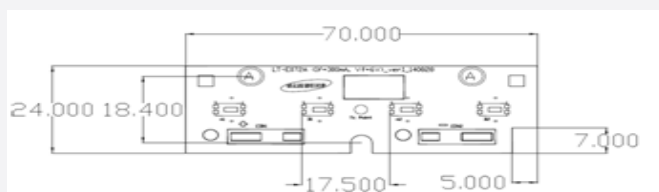

E282A

imension	Specification	Tolerance	Unit
Module Length	280.0	± 0.5	mm
Module Width	24.0	± 0.3	mm
Module Height	5.8	± 0.3	mm
PCB Thickness	1.6	± 0.16	mm
Module Weight	22.0	± 1.1	g

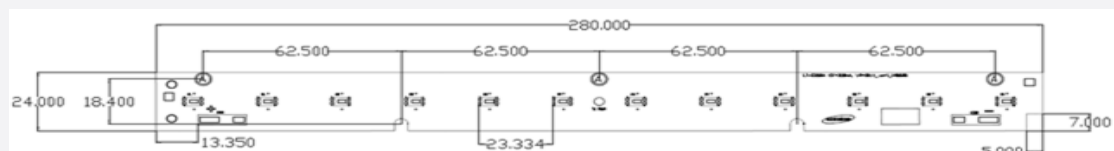

E562A

imension	Specification	Tolerance	Unit
Module Length	560.0	± 0.5	mm
Module Width	24.0	± 0.3	mm
Module Height	5.8	± 0.3	mm
PCB Thickness	1.6	± 0.16	mm
Module Weight	42.0	± 2.2	g

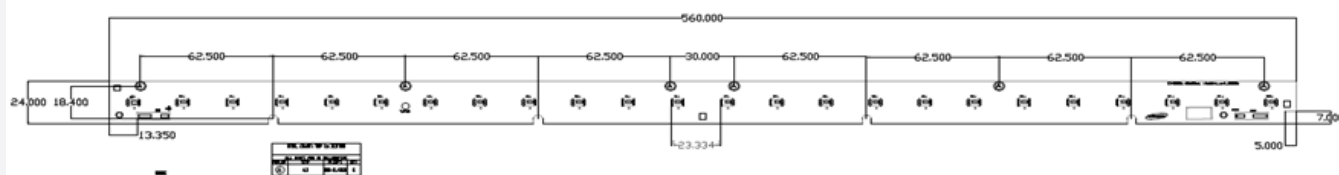

c) Assembly

Connectors on the board are provided for easy wiring with the LED driver and between modules



d) Structure

Item	Specification
LED	LM561B Middle Power LED
PCB	Material: copper, solder mask, epoxy
Connector	Reworkable poke-in connector type
Wire	24~18 AWG; terminal strip length of 7.5~8.5 mm

e) Light Distribution

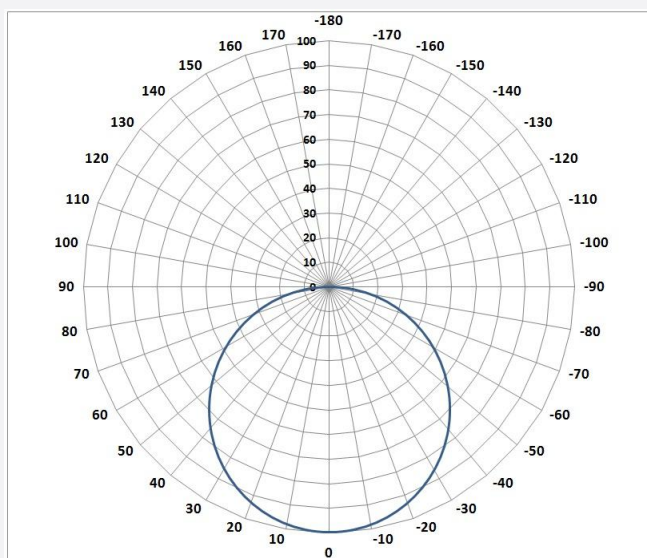

f) Thermal Management

Performance temperatures are measured on “Tc point” as indicated on the module.

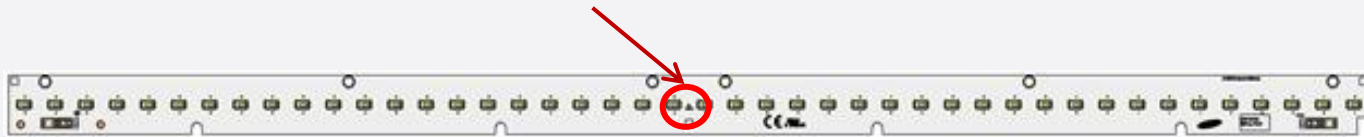

g) Schematic Circuit

E072A

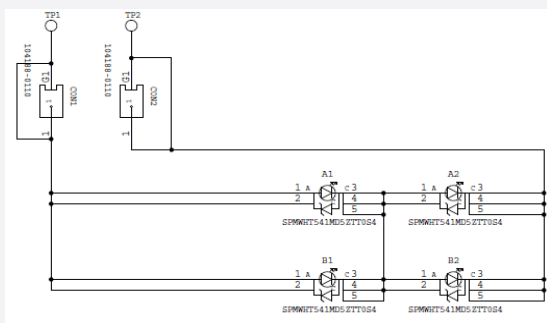

E282A

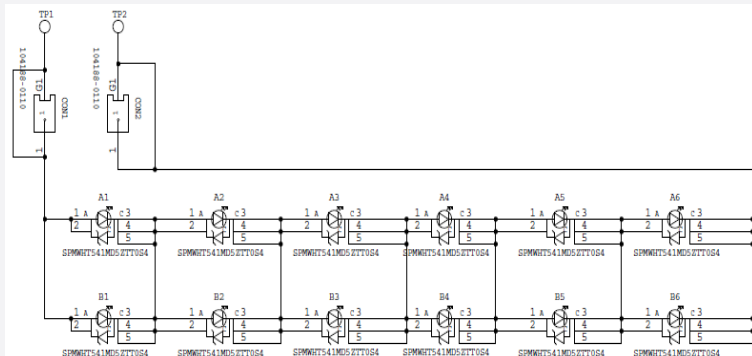

E562A

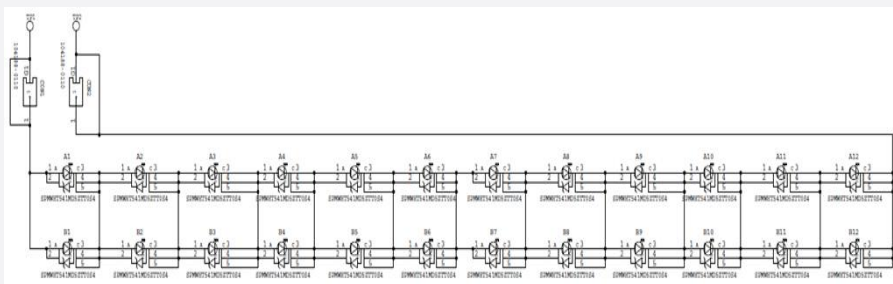

4. Certification and Declaration

Item	Compliant to	Remark
Test & Certification	CE	IEC / EN 62031, IEC / EN 62471
	ENEC	IEC / EN 62031, IEC / EN 62471
	UL / cUL for Component	UL 8750
	Photobiological Safety (LM561B LED)	IEC / EN 62471
Declaration	RoHS	Hazardous Substance & Material
	REACH	Hazardous Substance & Material

5. Label Structure

a) Module Label

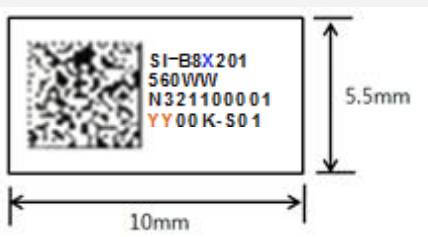

The lot number is composed of the following characters:

A. Barcode type : 2-dimensional data matrix code

B. Information of Barcode

① Example : SI-B8X071300WW_K2241000014000K-S01

② 38 digits: Model code (15) + Space (1) + SMT date (4) + SMT line No (1) + Serial No.(5)
+ Color temperature (5) + LED maker (2) + GROUP No (2)

C. Number information

① Model code: SI-B8X071300WW

X: W (2700K), V (3000K), U (3500K), T (4000K), R (5000K)

② Space: Space

③ SMT date: K224 (2010-February-24th)

A (2000), B(2001) ······ J(2009), K(2010), L(2011), ······ (year)

1(January), 2(February), ······ 9(September), A(October), B(November), C(December) (month)

01, 02, ······ 31th (date)

④ SMT Line No. : 1 line

1~9, A(10), B(11), C(12), D(13), E(14), F(15)

⑤ Serial No: 00001

00001~99999: Setting "00001" every working day

⑥ Color temperature: YZ00K

Y : 27, 30, 35, 40, 50

⑦ LED Maker: -S (Samsung)

⑧ Group No: 01 (Binning group)

b) Box Label

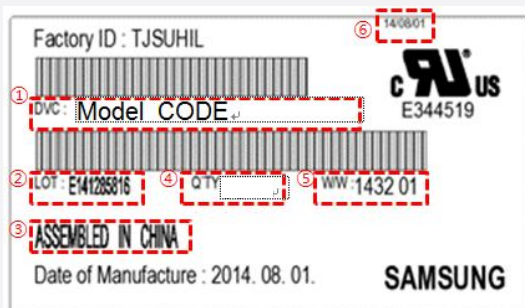

The lot number is composed of the following characters:

- ① : Product code
- ② : Lot ID
- ③ : Place of origin
- ④ : Quantity
- ⑤ : Describe production week
- ⑥ : Date of Issue

6. Packing Structure

a) Packing Process

E072A

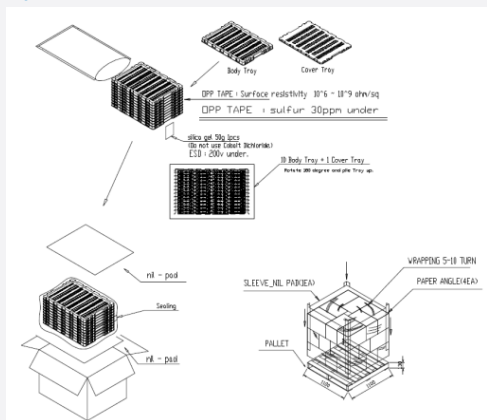

E282A

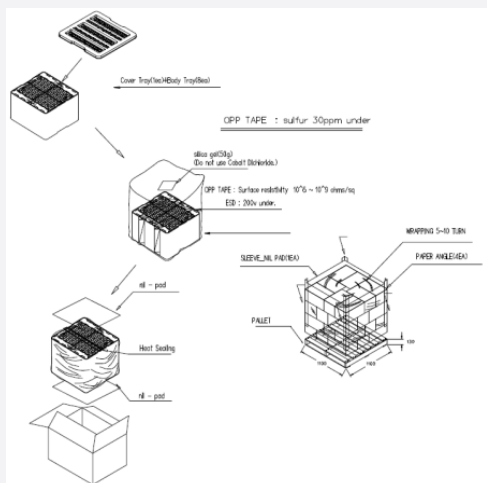

E562A

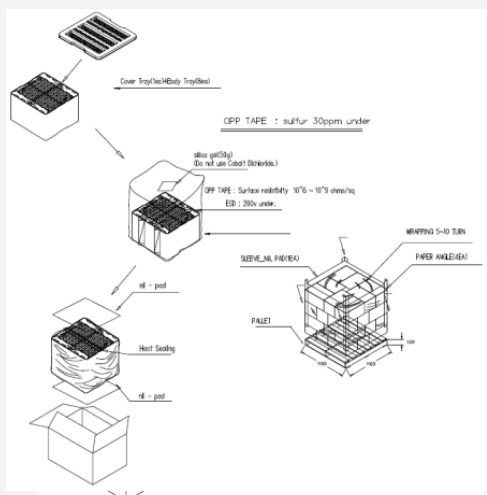

b) Packing**E072A**

Packing	Quantity (modules)	Dimension (mm)			
		Length	Width	Height	Tolerance
Outer Box	1500	430	310	275	±5
Pallet	36000	1100	1100	130	-

E282A

Packing	Quantity (modules)	Dimension (mm)			
		Length	Width	Height	Tolerance
Outer Box	320	385	335	225	±5
Pallet	10240	1100	1100	130	-

E562A

Packing	Quantity (modules)	Dimension (mm)			
		Length	Width	Height	Tolerance
Outer Box	240	615	335	225	±5
Pallet	3840	1100	1100	130	-

7. Precautions in Handling & Use

A. The LED Lighting Modules for white light are devices which are materialized by combining white LEDs.

The color of white light can differ a little unusually to diffuser plate(sign-board panel).

Also when the LEDs are illuminating, operating current should be decided after considering the ambient maximum temperature.

B. Handling

To prevent the LED Lighting Modules from making any defectives, please handle the LED Lighting Modules with care as follows.

- (1) Don't drop the unit and don't give the unit any shocks.
- (2) Don't bend the PCB and don't touch the LED Resin.
- (3) Don't storage the Module in a dusty place or room.
- (4) Don't take the product apart.
- (5) Don't touch the LED and also PCB and other circuit parts of Module with your naked fingers or sharpness things.
- (6) Take care so that do not pull wire with hand in case of carries or moves LED Lighting Modules.

C. Cleaning

The LED Lighting Modules should not be used in any type of fluid such as water, oil, organic solvent, etc.

It is recommended that IPA (Isopropyl Alcohol) be used as a solvent for cleaning the LED Lighting Modules.

When using other solvents, it should be confirmed beforehand whether the solvents will dissolve the package and the resin or not. Freon solvents should not be used to clean the LEDs because of worldwide regulations. Do not clean the LED Lighting Modules by the ultrasonic.

Before cleaning, a pre-test should be done to confirm whether any damage to the LED Lighting Modules will occur.

D. Static Electricity

Static electricity or surge voltage damages the LED Lighting Modules. Please keep the working process anti-static electricity condition to prevent the Lighting from destroying, as following.

- (1) Anyone who handles the unit should be well grounded.(earth ring or anti-static glove)
- (2) Anyone who handles the unit should wear anti-electrostatic working clothes.
- (3) All kinds of device and instruments, such as working table, measuring instruments and assembly jigs in your production lines should be well grounded.

E. Storage

The LED Lighting Modules must be stored to insert a package of a moisture absorbent material(silica gel) in a box.

F. Others

If over voltage which exceeds the absolute maximum rating is applied to LED Lighting Modules.

It will cause damage Circuits(that LED is included) and result in destruction.

Do not directly look into lighted LED with naked eyes.

Please use this product within 5 months, which is kept in its original packaging unopened when stocked

Legal and additional information.

[About Samsung Electronics Co., Ltd.](#)

Samsung Electronics Co., Ltd. is a global leader in technology, opening new possibilities for people everywhere. Through relentless innovation and discovery, we are transforming the worlds of TVs, smartphones, tablets, PCs, cameras, home appliances, printers, LTE systems, medical devices, semiconductors and LED solutions. We employ 286,000 people across 80 countries with annual sales of US\$216.7 billion. To discover more, please visit www.samsungled.com.

Copyright © 2015 Samsung Electronics Co., Ltd. All rights reserved.
Samsung is a registered trademark of Samsung Electronics Co., Ltd.
Specifications and designs are subject to change without notice. Non-metric weights and measurements are approximate. All data were deemed correct at time of creation. Samsung is not liable for errors or omissions. All brand, product, service names and logos are trademarks and/or registered trademarks of their respective owners and are hereby recognized and acknowledged.



Samsung Electronics Co., Ltd.
95, Samsung 2-ro
Giheung-gu
Yongin-si, Gyeonggi-do, 446-711
KOREA

www.samsungled.com



Looking for pricing, stock, or lifecycle information?

Click below to explore more details on WIN SOURCE:

-  [View SI-B8U112560WW on WIN SOURCE](#)
-  [Samsung Information](#)

Optimize Your Supply Chain with WIN SOURCE Solutions

-  Global Sourcing Solution
-  Obsolete Management
-  Cost Control Management
-  Shortage Management
-  Alternative Solution
-  Excess Inventory Management