



**THE DATASHEET OF  
SI-B8U052280WW**



## LED Module

# LT-M282A\_G2

# LT-M282B\_G2

# LT-M282C\_G2

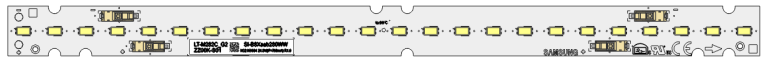
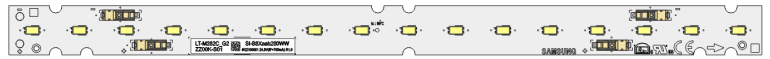
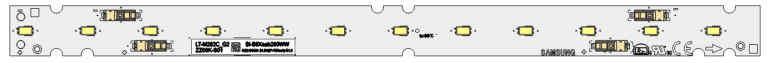

### Features & Benefits

- Easy connection with re-workable poke-in connector
- Fit better to replace conventional T5, T8 fixture with narrow width
- Full Certifications

### Applications

#### Indoor Lighting:

- Office / Retail / Living space
- Area Panels, Troffer and Linear Pendants
- Channel and Cove lighting

## Table of Contents

1.	Product Code Information	-----	3
2.	Characteristics	-----	4
3.	Structure and Assembly	-----	8
4.	Certification and Declaration	-----	12
5.	Label Structure	-----	13
6.	Packing Structure	-----	14
7.	Precautions in Handling & Use	-----	15
APPENDIX 1.	Tc vs Lifetime	-----	16
APPENDIX 2.	If vs Luminous Flux	-----	17
APPENDIX 3.	If vs Efficiency	-----	19

## 1. Product Code Information

### a) M282A\_G2

Nominal CCT (K)	Product Code
3000	SI-B8V052280WW
3500	SI-B8U052280WW
4000	SI-B8T052280WW
5000	SI-B8R052280WW

### b) M282B\_G2

Nominal CCT (K)	Product Code
3000	SI-B8V072280WW
3500	SI-B8U072280WW
4000	SI-B8T072280WW
5000	SI-B8R072280WW

### c) M282C\_G2

Nominal CCT (K)	Product Code
3000	SI-B8V114280WW
3500	SI-B8U114280WW
4000	SI-B8T114280WW
5000	SI-B8R114280WW

## 2. Characteristics

Item	Rating	Unit	Remark
Rated Lifetime	>50,000	hour	L70B50
Ingress Protection (IP)	no rating	-	
Ambient / Operating Temperature ( $t_{amb}$ )	-20 ~ +50	°C	
Storage Temperature	-30 ~ +80	°C	

### (a) M282A\_G2

Item	Nom. CCT (K)	Rating			Unit	Remark
		Min	Typ.	Max		
Luminous Flux ( $\Phi_v$ )	3000	710	790	880	lm	
	3500	720	800	890		
	4000	745	825	920		
	5000	745	825	920		
Luminous Efficacy	3000	127	142	158	lm/W	$I_f = 450 \text{ mA}$ $t_p = 50 \text{ }^\circ\text{C}$
	3500	129	143	159		
	4000	134	148	165		
	5000	134	148	165		
CCT	3000	2922	3038	3166	K	
	3500	3307	3455	3621		
	4000	3781	3975	4188		
	5000	4789	5030	5302		
Color Consistency (initial)		-	4	-	Mac Adam step	
Color Rendering Index (Ra)		80	83	-	-	
Operating Current ( $I_f$ )		-	450	540	mA	-
Operating Voltage ( $V_f$ )		11.16	12.4	13.64	Vdc	$I_f = 450 \text{ mA}$ $t_p = 50 \text{ }^\circ\text{C}$
Power Consumption		5.0	5.6	6.1	W	

#### Notes:

- 1)  $t_p$ : temperature at which performance is specified; measured at “tc point”.
- 2) Samsung maintains a measurement tolerance of: Luminous flux:  $\pm 7\%$ , CRI:  $\pm 3.0$ , Voltage:  $\pm 0.3\text{V}$ , Power Consumption:  $\pm 0.3\text{W}$

## (b) M282B\_G2

Item	Nom. CCT (K)	Rating			Unit	Remark
		Min	Typ.	Max		
Luminous Flux ( $\Phi_v$ )	3000	945	1050	1170	lm	I <sub>f</sub> = 300 mA t <sub>p</sub> = 50 °C
	3500	965	1070	1190		
	4000	990	1100	1220		
	5000	990	1100	1220		
Luminous Efficacy	3000	127	141	157	lm/W	
	3500	130	144	160		
	4000	133	148	164		
	5000	133	148	164		
CCT	3000	2922	3038	3166	K	
	3500	3307	3455	3621		
	4000	3781	3975	4188		
	5000	4789	5030	5302		
Color Consistency (initial)		-	4	-	Mac Adam step	
Color Rendering Index (Ra)		80	83	-	-	
Operating Current (I <sub>f</sub> )		-	300	360	mA	-
Operating Voltage (V <sub>f</sub> )		23.56	24.8	26.04	Vdc	I <sub>f</sub> = 300 mA t <sub>p</sub> = 50 °C
Power Consumption		7.1	7.4	7.8	W	t <sub>p</sub> = 50 °C

**Notes:**

- 3) t<sub>p</sub>: temperature at which performance is specified; measured at “tc point”.
- 4) Samsung maintains a measurement tolerance of: Luminous flux: ±7%, CRI: ±3.0, Voltage: ±0.3V, Power Consumption: ±0.3W

## (c) M282C\_G2

Item	Nom. CCT (K)	Rating			Unit	Remark
		Min	Typ.	Max		
Luminous Flux ( $\Phi_v$ )	3000	1420	1580	1755	lm	I <sub>f</sub> = 450 mA t <sub>p</sub> = 50 °C
	3500	1445	1605	1785		
	4000	1485	1650	1835		
	5000	1485	1650	1835		
Luminous Efficacy	3000	127	142	157	lm/W	
	3500	129	144	160		
	4000	133	148	164		
	5000	133	148	164		
CCT	3000	2922	3038	3166	K	
	3500	3307	3455	3621		
	4000	3781	3975	4188		
	5000	4789	5030	5302		
Color Consistency (initial)		-	4	-	Mac Adam step	
Color Rendering Index (Ra)		80	83	-	-	
Operating Current (I <sub>f</sub> )		-	450	540	mA	-
Operating Voltage (V <sub>f</sub> )		23.56	24.8	26.04	Vdc	I <sub>f</sub> = 450 mA t <sub>p</sub> = 50 °C
Power Consumption		10.6	11.2	11.7	W	t <sub>p</sub> = 50 °C

**Notes:**

- 5) t<sub>p</sub>: temperature at which performance is specified; measured at “tc point”.
- 6) Samsung maintains a measurement tolerance of: Luminous flux: ±7%, CRI: ±3.0, Voltage: ±0.3V, Power Consumption: ±0.3W

Item	Nominal*	Life**	Max***	Unit
Temperature	50 ( $t_p$ )	80( $t_{p,50}$ )	90( $t_c$ )	°C

**Notes:**

- \* Temperature used to specify performance of the module ( $t_p$ ).
- \*\* Rated maximum performance temperature at which lifetime is specified ( $t_{p,50}$ ).
- \*\*\* Rated maximum temperature, highest permissible temperature to avoid safety risk ( $t_c$ ).

All temperatures are measured at the designated “tc point” as indicated on the module.

### 3. Structure and Assembly

#### a) Appearance

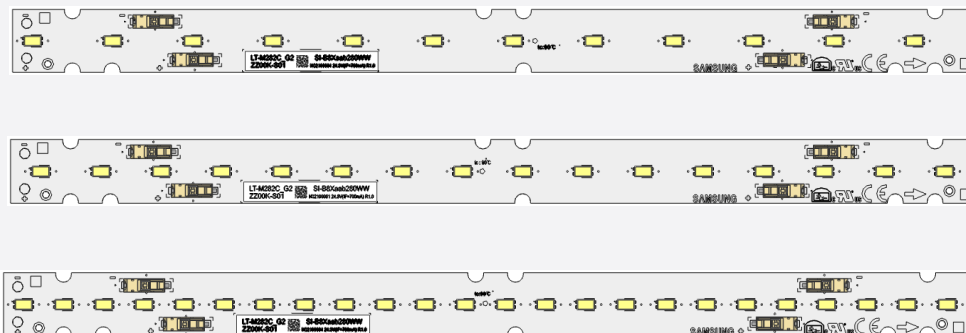

#### b) Dimension

##### M282A\_G2

Dimension	Specification	Tolerance	Unit
Module Length	275.0	$\pm 0.4$	mm
Module Width	18.0	$\pm 0.3$	mm
Module Height	5.8	$\pm 0.3$	mm
PCB Thickness	1.6	$\pm 0.16$	mm
Module Weight	13.0	$\pm 1.0$	g

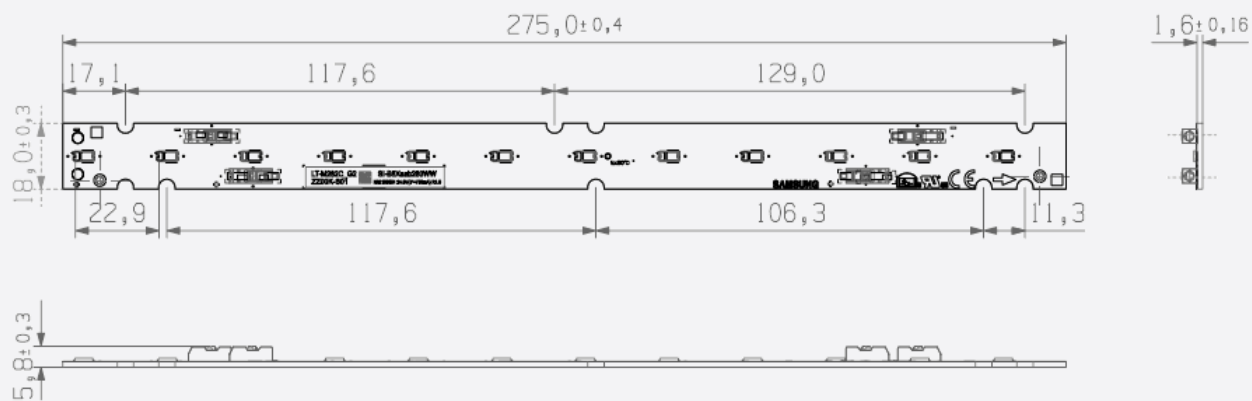

## M282B\_G2

Dimension	Specification	Tolerance	Unit
Module Length	275.0	$\pm 0.4$	mm
Module Width	18.0	$\pm 0.3$	mm
Module Height	5.8	$\pm 0.3$	mm
PCB Thickness	1.6	$\pm 0.16$	mm
Module Weight	13.5	$\pm 1.0$	g

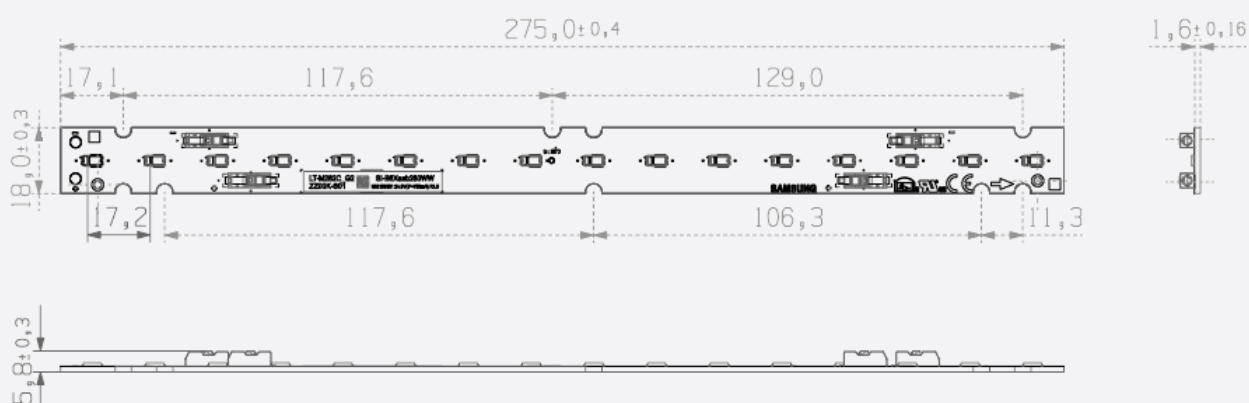

## M282C\_G2

Dimension	Specification	Tolerance	Unit
Module Length	275.0	$\pm 0.4$	mm
Module Width	18.0	$\pm 0.3$	mm
Module Height	5.8	$\pm 0.3$	mm
PCB Thickness	1.6	$\pm 0.16$	mm
Module Weight	14.0	$\pm 1.0$	g

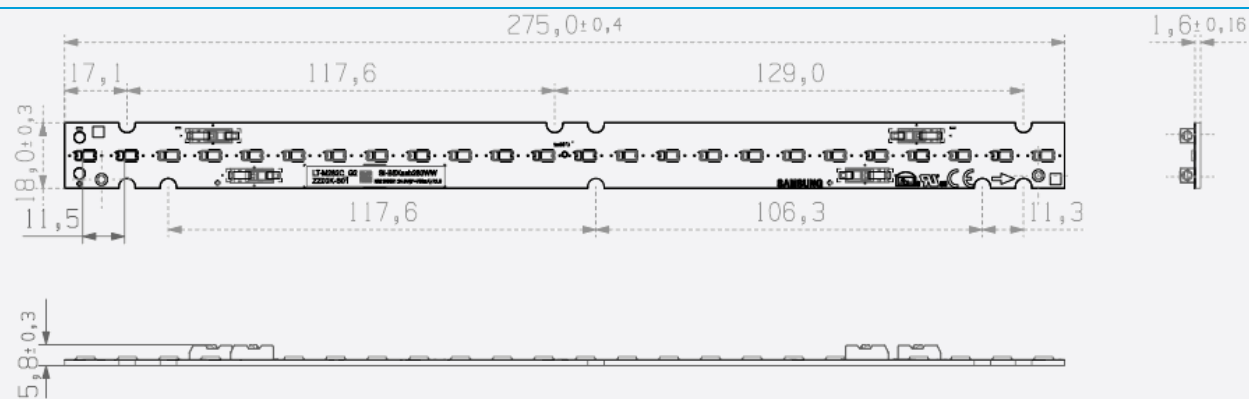

### c) Assembly

Connectors on the board are provided for easy wiring with the LED driver and between modules

[Front connector]

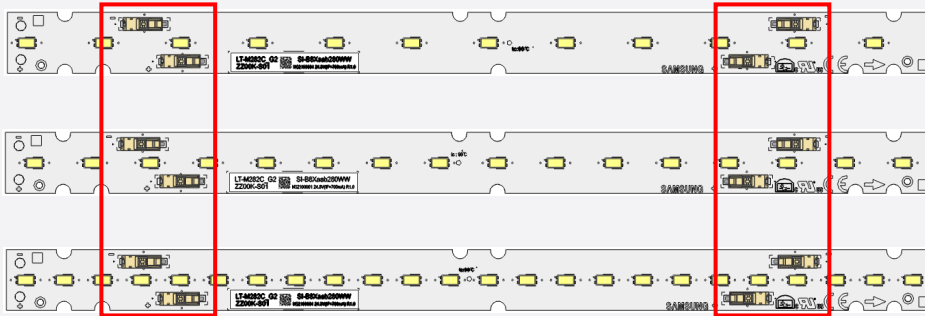
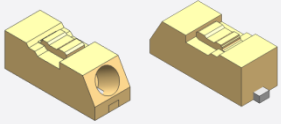

### d) Structure

Item	Specification
LED	LM561B+ Middle Power LED
PCB	Material: copper, solder mask, epoxy
Connector	Reworkable poke-in connector type
Wire	0.2~0.75 mm <sup>2</sup> (24~18 AWG)

### e) Light Distribution

Polar Intensity Diagram: Beam Angle  $115 \pm 5^\circ$

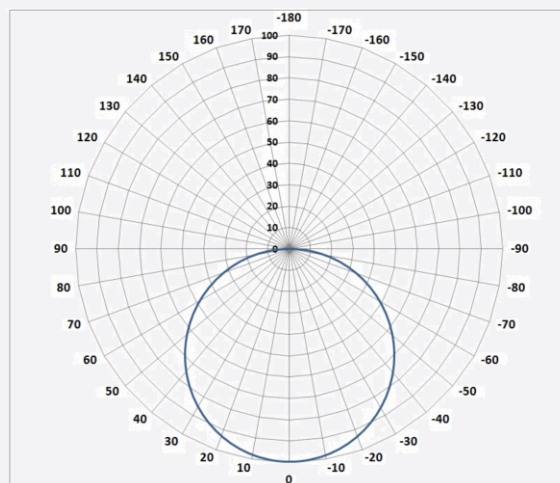

**f) Thermal Management**

Performance temperatures are measured on “tc point” as indicated on the module.

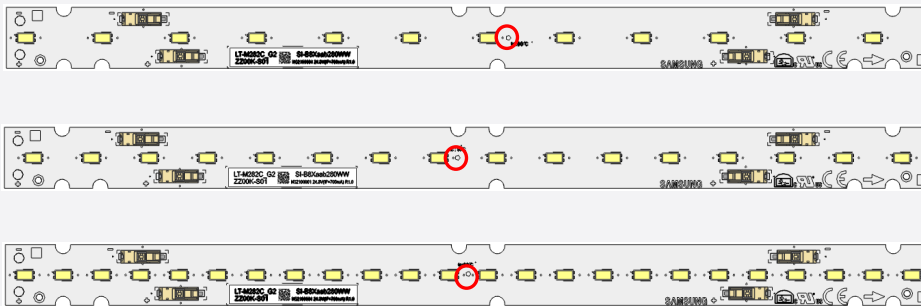

**g) Schematic Circuit**

M282A\_G2 (4S3P)

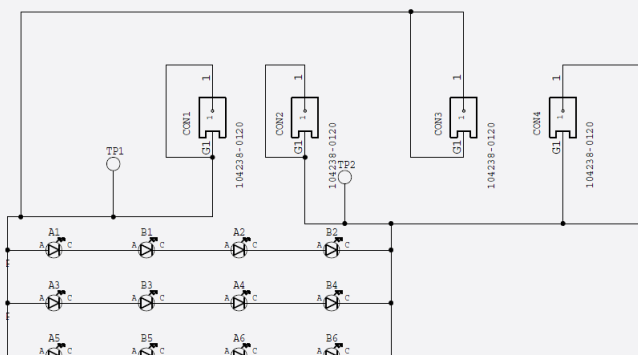

M282B\_G2 (8S2P)

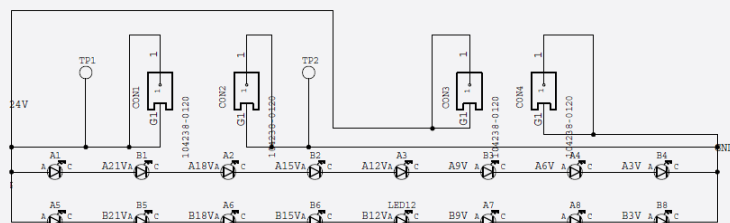

M282C\_G2 (8S3P)

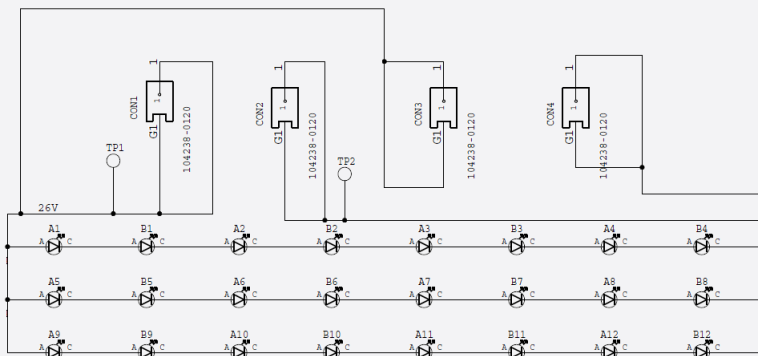

#### 4. Certification and Declaration

Item	Compliant to	Remark
Test & Certification	CE	IEC / EN 62031, IEC / EN 62471
	ENEC	-
	VDE	-
	UL	E344519
	cUL	E344519
	Photo biological Safety(LM561B+ LED)	IEC / EN 62471
Declaration	RoHS	Hazardous Substance & Material
	REACH	Hazardous Substance & Material

## 5. Label Structure

### a) Module Label

[Printing Label]

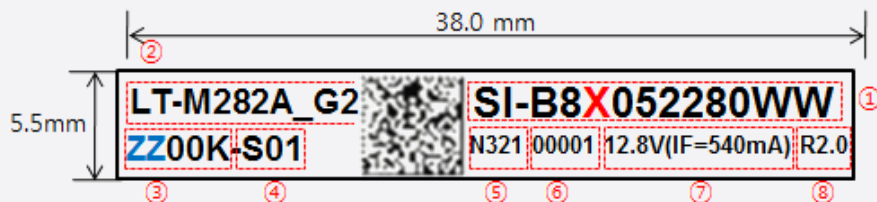

[Information of Barcode]

- ① Model code: SI-B8X052280WW  
 SI-B8X072280WW  
 SI-B8X114280WW  
 X: V (3000K), U (3500K), T (4000K), R (5000K)
- ② Product name: LT-M282A\_G2  
 LT-M282B\_G2  
 LT-M282C\_G2
- ③ Color temperature: ZZ00K  
 ZZ: 30, 35, 40, 50
- ④ LED maker: -S (Samsung)  
 Group No.: 01 (Binning group)
- ⑤ SMT date: N321 (2013-March-21)  
 A (2000), B (2001) ······ K (2010), L (2011), M (2012), N (2013) ······ (year)  
 1 (January), ······ 9(September), A (October), B (November), C (December) (month)  
 01, 02, 03, ······ 31th (date)
- ⑥ Serial No.: 00001~99999; Setting "00001" every working day
- ⑦ Voltage (IF=mA))
- ⑧ Product Revision: R2.0

[QR CODE Information]

- ① Example: SI-B8X052280WW\_ N321100001ZZ00K-S01
- ② 34 digits: Model code (14) + Space (1) + SMT date (4) + SMT line No. (1) + Serial No. (5)  
 + Color temperature (5) + Dash(1)+LED maker (1) + GROUP No. (2)

Model CODE	SI-B8X052280WW
QR CODE Information	SI-B8X052280WW_N321100001ZZ00K-S01

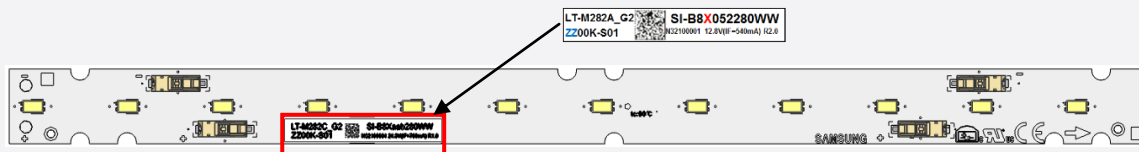

**b) Tray & MBB Label**

- 100mm x 50mm

Ex)



- ① Model code: SI-B8X052280WW
- ② LOT: 20150101-D0001  
 Packing Date(8 digit) → 20150101  
 Production Site(1digit) → PyeongTaek SUHIL(E), TianJIn SUHIL(D)  
 Serial no(4 digit) → 0001~9999, A111~A999
- ③ QTY: Quantity of Packaged Bar (5 Digit)
- ④ W/W: Production Year(2 digit) + Production Week(2 digit)
- ⑤ Issue date of Label: 12:year/01:month/30:day

**c) Box Label**

- 100mm x 50mm

Ex)

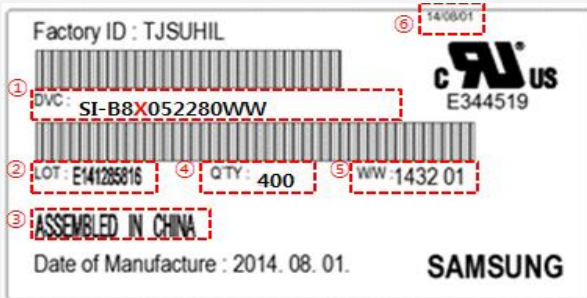

The lot number is composed of the following characters:

- ① Product code
- ② Lot ID
- ③ Place of origin
- ④ Quantity
- ⑤ Describe production week
- ⑥ Date of Issue

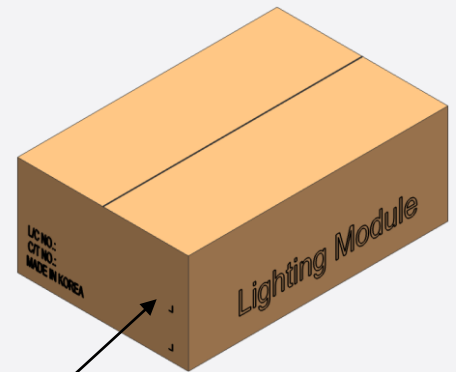

**6. Packing Structure**

ARTICLE	TRAY	BOX	PALLET	REMARKS
Quantity	40 ea	400 ea	12,800 ea	

## 7. Precautions in Handling & Use

A. The LED Lighting Modules for white light are devices which are materialized by combining white LEDs.

The color of white light can differ a little unusually to diffuser plate(sign-board panel).

Also when the LEDs are illuminating, operating current should be decided after considering the ambient maximum temperature.

### B. Handling

To prevent the LED Lighting Modules from making any defectives, please handle the LED Lighting Modules with care as follows.

- (1) Don't drop the unit and don't give the unit any shocks.
- (2) Don't bend the PCB and don't touch the LED Resin.
- (3) Don't storage the Module in a dusty place or room.
- (4) Don't take the product apart.
- (5) Don't touch the LED and also PCB and other circuit parts of Module with your naked fingers or sharpness things.
- (6) Take care so that do not pull wire with hand in case of carries or moves LED Lighting Modules.

### C. Cleaning

The LED Lighting Modules should not be used in any type of fluid such as water, oil, organic solvent, etc.

It is recommended that IPA (Isopropyl Alcohol) be used as a solvent for cleaning the LED Lighting Modules.

When using other solvents, it should be confirmed beforehand whether the solvents will dissolve the package and the resin or not. Freon solvents should not be used to clean the LEDs because of worldwide regulations. Do not clean the LED Lighting Modules by the ultrasonic.

Before cleaning, a pre-test should be done to confirm whether any damage to the LED Lighting Modules will occur.

### D. Static Electricity

Static electricity or surge voltage damages the LED Lighting Modules. Please keep the working process anti-static electricity condition to prevent the Lighting from destroying, as following.

- (1) Anyone who handles the unit should be well grounded.(earth ring or anti-static glove)
- (2) Anyone who handles the unit should wear anti-electrostatic working clothes.
- (3) All kinds of device and instruments, such as working table, measuring instruments and assembly jigs in your production lines should be well grounded.

### E. Storage

The LED Lighting Modules must be stored to insert a package of a moisture absorbent material(silica gel) in a box.

### F. Others

If over voltage which exceeds the absolute maximum rating is applied to LED Lighting Modules.

It will cause damage Circuits(that LED is included) and result in destruction.

Do not directly look into lighted LED with naked eyes.

Please use this product within 5 months, which is kept in its original packaging unopened when stocked

## APPENDIX 1. Tc vs Lifetime

M282A\_G2, M282B\_G2, M282C\_G2

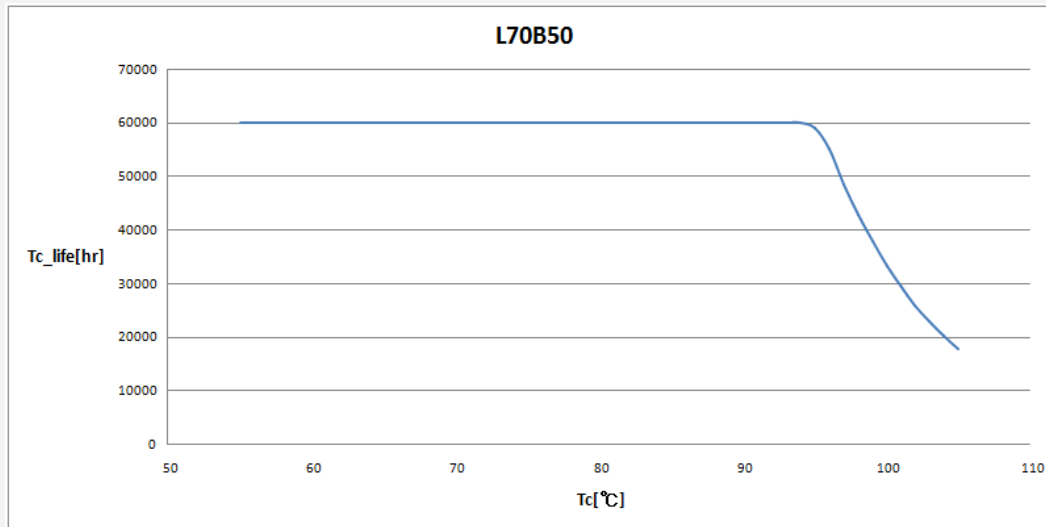

@150mA/LED

## APPENDIX 2. If vs Luminous Flux

### (a) M282A\_G2

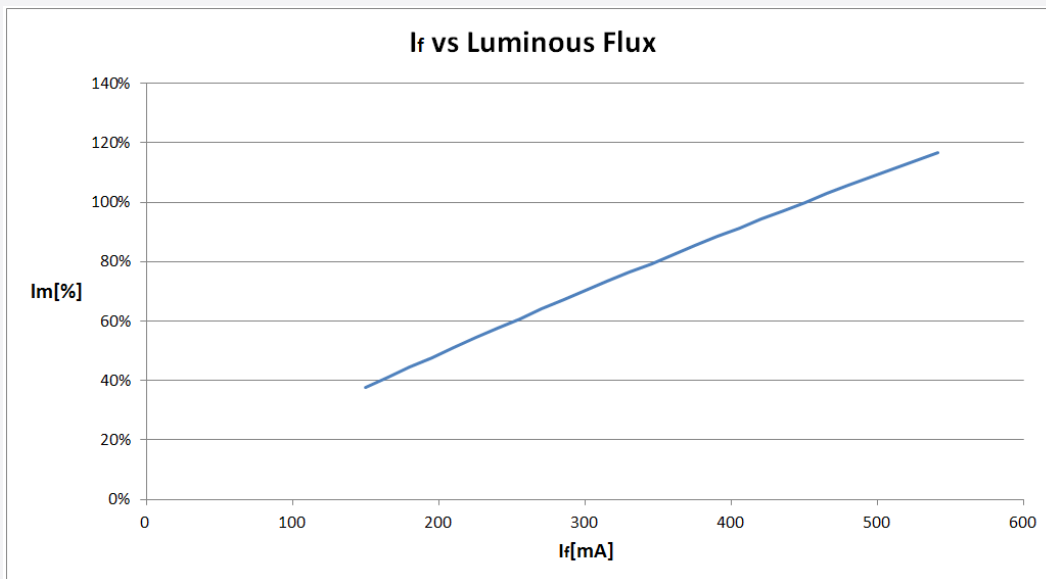

### (b) M282B\_G2

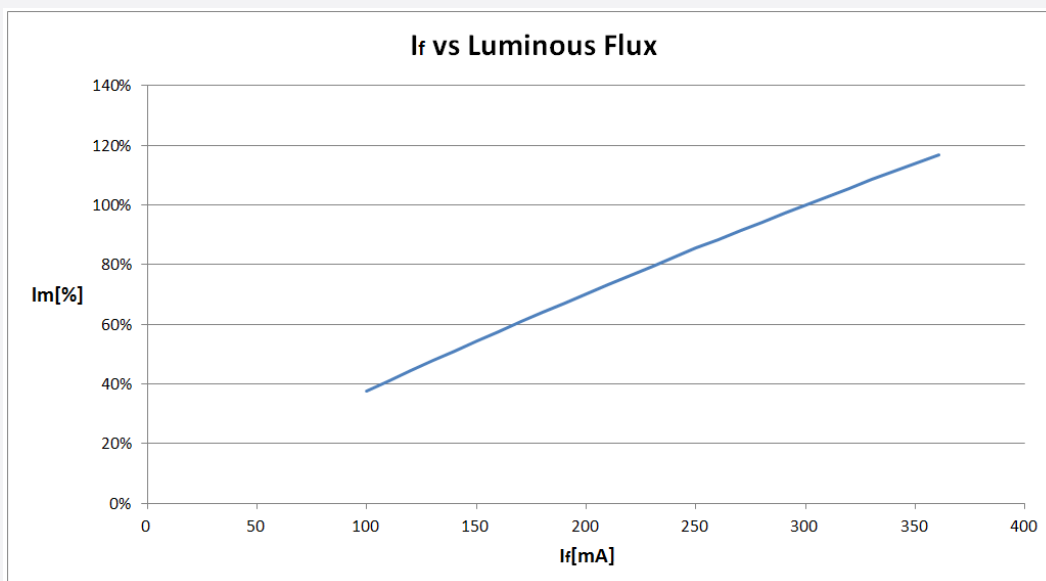

(c) M562C\_G2

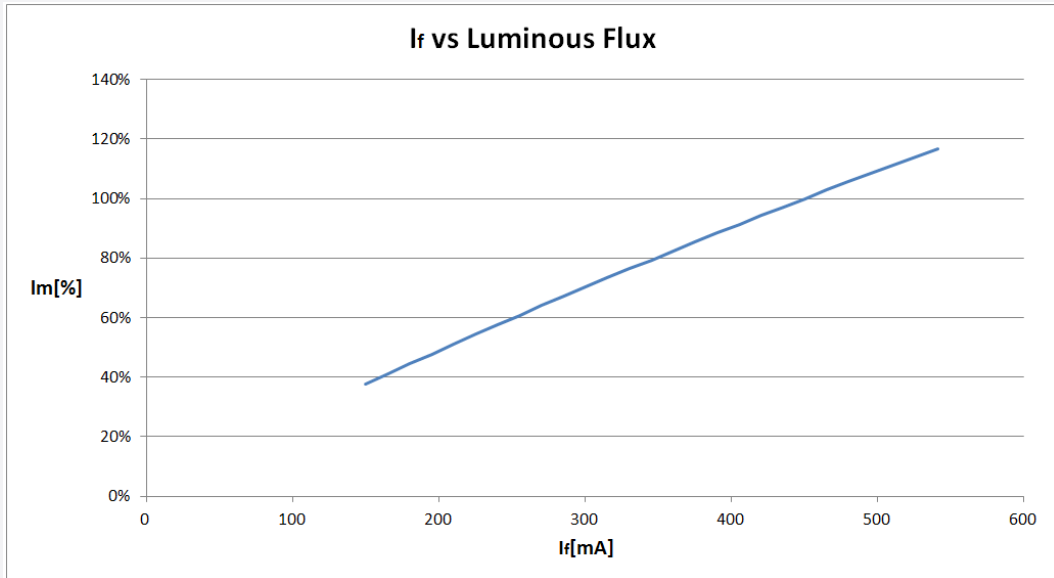

### APPENDIX 3. $I_f$ vs Efficiency

(a) M282A\_G2

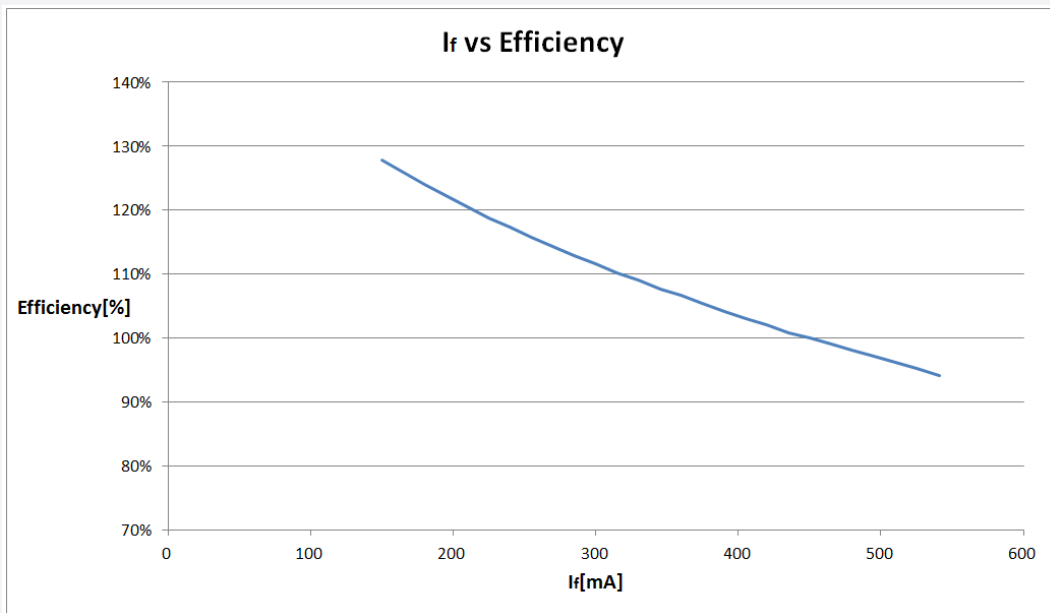

(b) M282B\_G2

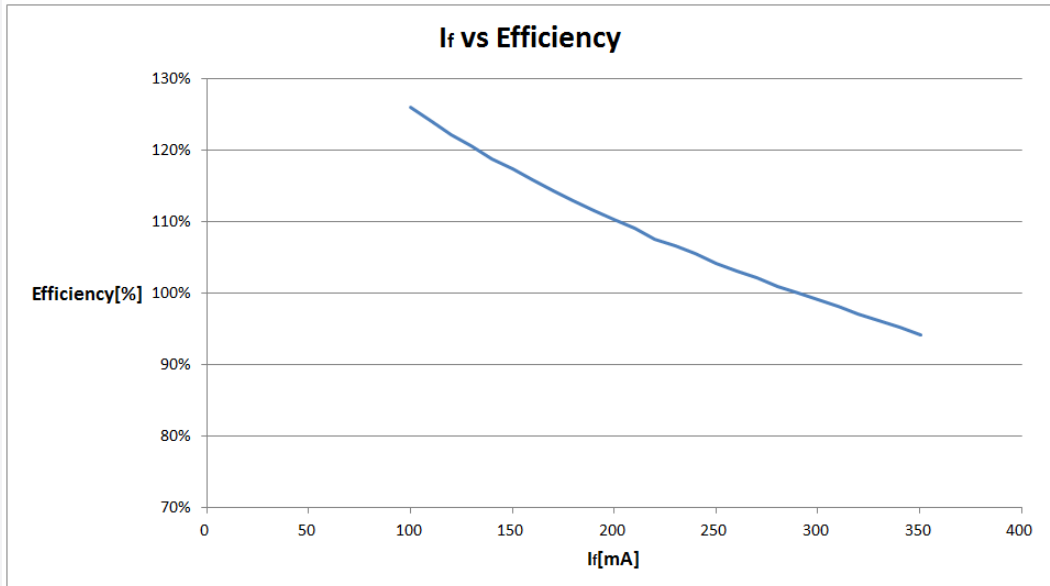

(C) M282C\_G2

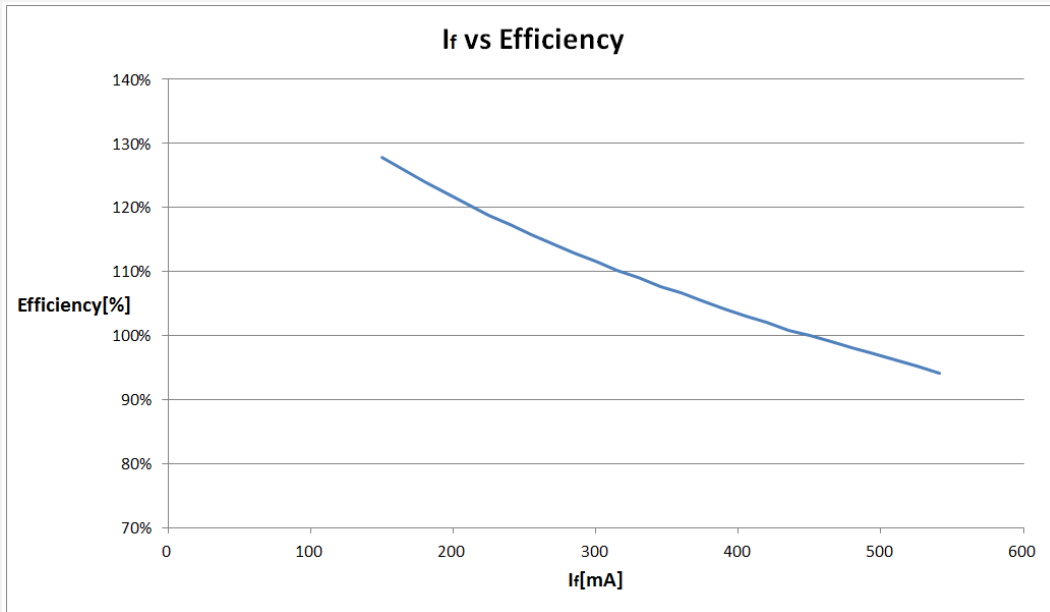

# Legal and additional information.

## [About Samsung Electronics Co., Ltd.](#)

Samsung Electronics Co., Ltd. is a global leader in technology, opening new possibilities for people everywhere. Through relentless innovation and discovery, we are transforming the worlds of TVs, smartphones, tablets, PCs, cameras, home appliances, printers, LTE systems, medical devices, semiconductors and LED solutions. We employ 286,000 people across 80 countries with annual sales of US\$216.7 billion. To discover more, please visit [www.samsungled.com](http://www.samsungled.com).

Copyright © 2016 Samsung Electronics Co., Ltd. All rights reserved.  
Samsung is a registered trademark of Samsung Electronics Co., Ltd.  
Specifications and designs are subject to change without notice. Non-metric weights and measurements are approximate. All data were deemed correct at time of creation. Samsung is not liable for errors or omissions. All brand, product, service names and logos are trademarks and/or registered trademarks of their respective owners and are hereby recognized and acknowledged.

Samsung Electronics Co., Ltd.  
95, Samsung 2-ro  
Giheung-gu  
Yongin-si, Gyeonggi-do, 446-711  
KOREA

[www.samsungled.com](http://www.samsungled.com)

**SAMSUNG**

## Looking for pricing, stock, or lifecycle information?

Click below to explore more details on WIN SOURCE:

- ⊖ [View SI-B8U052280WW](#) on WIN SOURCE
- ⊖ [Samsung](#) Information

## Optimize Your Supply Chain with WIN SOURCE Solutions

- ✓ Global Sourcing Solution
- ✓ Obsolete Management
- ✓ Cost Control Management
- ✓ Shortage Management
- ✓ Alternative Solution
- ✓ Excess Inventory Management