

UNCONTROLLED DOCUMENT

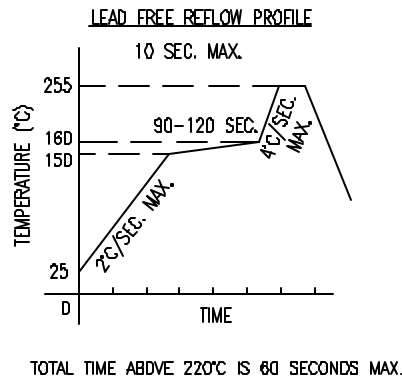

SOLDER PAD LAYOUT

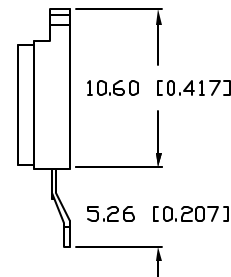
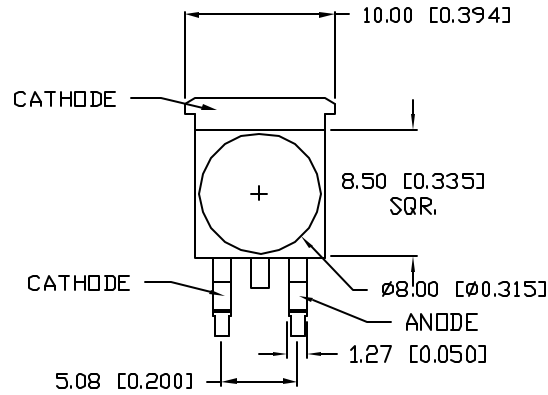
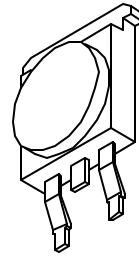
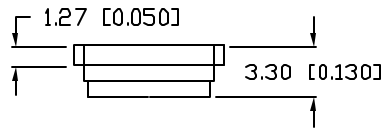
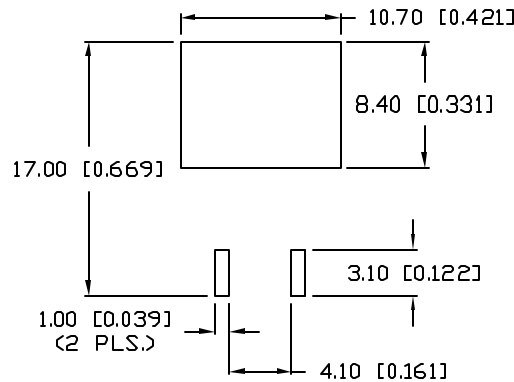

PART NUMBER
SML-LX1610UWC/A

REV.

A

REV.	E.C.N. NUMBER AND REVISION COMMENTS	DATE
A	E.C.N. #11388.	01.11.07

ELECTRO-OPTICAL CHARACTERISTICS $T_A=25^\circ\text{C}$ $I_f=350\text{mA}$

PARAMETER	SYMBOL	MIN	TYP	MAX	UNITS	TEST COND
PEAK WAVELENGTH			-		nm	
FORWARD VOLTAGE	V_f		3.5	4.0	V	$I_f=350\text{mA}$
REVERSE VOLTAGE	V_r	5			V	$I_f=10\mu\text{A}$
AXIAL INTENSITY(*1)	I_v		30		lm	$I_f=350\text{mA}$
COLOR TEMP.		3000		9000		$I_f=350\text{mA}$
VIEWING ANGLE			110		$2x \theta_{\text{half}}$	
EMITTED COLOR:			WHITE			
EPOXY LENS FINISH:			WATER CLEAR			

*1. AXIAL INTENSITY TESTING CONDITION: 550nm WAVELENGTH.
*2. THE ICI STANDARD COLORIMETRIC SYSTEM.

LIMITS OF SAFE OPERATION AT 25°C

PARAMETER	SYMBOL	MAX	UNITS
PULSE FORWARD CURRENT	I_p	500	mA
STEADY CURRENT	I_F	350	mA
POWER DISSIPATION	P_D	1.5	W
OPERATING TEMP.	T_{OPR}	-20 TO +70	°C
STORAGE TEMP.	T_{STG}	-40 TO +85	°C

*DUTY 1/10 PULSE WIDTH 10ms

CAUTION: STATIC SENSITIVE DEVICE
FOLLOW PROPER E.S.D. HANDLING PROCEDURES
WHEN WORKING WITH THIS PART.

NOTES:

1. 50 PCS. IN EACH TUBE.

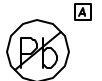

UNCONTROLLED DOCUMENT

*UNLESS OTHERWISE SPECIFIED TOLERANCES PER DECIMAL PRECISION ARE: X=±1 (±0.039), XX=±0.5 (±0.020), XXX=±0.25 (±0.010), XXXX=±0.127 (±0.005). LEAD SIZE=±0.05 (±0.002), LEAD LENGTH=±0.75 (±0.030). MIN=+DECIMAL PRECISION MAX.=+0.00 -DECIMAL PRECISION

REV.

A

PART NUMBER

SML-LX1610UWC/A

CONFIDENTIAL INFORMATION

THE INFORMATION CONTAINED IN THIS DOCUMENT IS THE PROPERTY OF LUMEX INC. EXCEPT AS SPECIFICALLY AUTHORIZED IN WRITING BY LUMEX INC, THE HOLDER OF THIS DOCUMENT SHALL KEEP ALL INFORMATION CONTAINED HEREIN CONFIDENTIAL AND SHALL PROTECT SAME IN WHOLE OR IN PART FROM DISCLOSURE AND DISSEMINATION TO ALL THIRD PARTIES.



290 E. HELEN ROAD
PALATINE, IL 60067-6976
PHONE: +1.847.359.2790
US WEB: www.lumex.com
TW WEB: www.lumex.com.tw

10.60 x 10mm HIGH POWER LED, ULTRA WHITE.

RELIABILITY NOTE

OUR MANY YEARS OF EXPERIENCE DATA ACCUMULATION INDICATE THAT SOLDER HEAT IS A MAJOR CAUSE OF EARLY AND FUTURE FAILURE. PLEASE PAY ATTENTION TO YOUR SOLDERING PROCESS.

DRAWN BY: JC	CHECKED BY:	APPROVED BY:	DATE: 8.31.06
			PAGE: 1 OF 1
			SCALE: N/A

Looking for pricing, stock, or lifecycle information?

Click below to explore more details on WIN SOURCE:

- ⊖ [View SML-LX1610UWC/A on WIN SOURCE](#)
- ⊖ [Lumex Opto/Components Inc. Information](#)

Optimize Your Supply Chain with WIN SOURCE Solutions

- ✓ Global Sourcing Solution
- ✓ Obsolete Management
- ✓ Cost Control Management
- ✓ Shortage Management
- ✓ Alternative Solution
- ✓ Excess Inventory Management