



**THE DATASHEET OF
SPMWHT541ML5XASKS6**



Middle Power LED Series
5630

LM561C



LM561C is highest performance and lm/W for fluorescent replacement



Features & Benefits

- 0.3 W class middle power LED
- Mold resin for high reliability
- Standard form factor for design flexibility (5.6 × 3.0 mm)

Table of Contents

1.	Characteristics	-----	3
2.	Product Code Information	-----	5
3.	Typical Characteristics Graphs	-----	14
4.	Outline Drawing & Dimension	-----	16
5.	Reliability Test Items & Conditions	-----	17
6.	Soldering Conditions	-----	18
7.	Tape & Reel	-----	19
8.	Label Structure	-----	21
9.	Packing Structure	-----	22
10.	Precautions in Handling & Use	-----	27

1. Characteristics

a) Absolute Maximum Rating

Item	Symbol	Rating	Unit	Condition
Ambient / Operating Temperature	T_a	-40 ~ +85	°C	-
Storage Temperature	T_{stg}	-40 ~ +120	°C	-
LED Junction Temperature	T_j	110	°C	-
Forward Current	I_F	200	mA	-
Peak Pulsed Forward Current	I_{fp}	300	mA	Duty 1/10, pulse width 10 ms
Assembly Process Temperature	-	260 <10	°C s	-
ESD (HBM)	-	±5	kV	-

b) Electro-optical Characteristics (I_F = 65 mA, T_s = 25 °C)

Item	Unit	CRI (R _a) Min.	Nominal CCT (K)	Rank	Bin	Min.	Typ.	Max.
Forward Voltage (V _F)	V			XA	AY	2.6	-	2.7
					AZ	2.7	-	2.8
					A1	2.8	-	2.9
Luminous Flux (Φ _v)	lm	80	5000		S5	35.0	-	37.0
					S6	37.0	-	39.0
Reverse Voltage (@ 5 mA)	V					0.7	-	1.2
Color Rendering Index (R _a)	-			5		80	-	-
Special CRI (R9)	-					0	-	-
Thermal Resistance (junction to solder point)	°C/W					-	14	20
Beam Angle	°					-	120	-

Note:

Samsung maintains measurement tolerance of: forward voltage = ±0.1 V, luminous flux = ±5 %, CRI = ±3, R9 = ±6.5

2. Product Code Information

1	2	3	4	5	6	7	8	9	10	11	12	13	14	15	16	17	18
S	P	M	W	H	T	5	4	1	M	L	5	X	K	S	K	S	5

Digit	PKG Information	Code	Specification
1 2 3	Samsung Package Middle Power	SPM	
4 5	Color	WH	White
6	Product Version	T	
7 8 9	Form Factor	541	5.6 x 3.0 x 0.7 mm; 4 pads; LM561C
10	Sorting Current (mA)	M	65 mA
11	Chromaticity Coordinates	L	Ansi Standard
12	CRI	5	Min. 80
13 14	Forward Voltage (V)	XA XK	2.6~2.9V (2,500 pcs/Reel) 2.6~2.9V (10,000 pcs/Reel)
15 16	CCT (K)	S★	5000 Bin Code: R6, R7, R8, S5, RA, RB, RC, S9, RE, RF, RG, SD, RU, RV, RW, ST ★ : "0" (Whole bin) "M" (Quarter bin), "K" (K Kitting), "N"(S Kitting) or "G"(L Kitting)
17 18	Luminous Flux	S0 S5 S6	Bin Code: S5 S6

a) Luminous Flux Bins($I_F = 65 \text{ mA}$, $T_s = 25^\circ\text{C}$)

CRI (R_a) Min.	Nominal CCT (K)	Product Code	Flux Bin	Flux Range (Φ_v , lm)
80	5000	SPMWHT541ML5X◆S☆S5	S5	35.0 ~ 37.0
		SPMWHT541ML5X◆S☆S6	S6	37.0 ~ 39.0

Note:

"◆" can be "A" (2,500pcs) or "K" (10,000pcs) of reel taping

"☆" can be "0" (Whole bin), "M" (Quarter bin), "K" (K Kitting) , "N" (N Kitting) or "G" (G Kitting) of the color binning

b) Kitting rule

1) K Kitting Concept

1. Under agreement between customer and SAMSUNG ELECTRONICS, SAMSUNG can supply kitting bin (VF, Color, Im).
2. A forward voltage (VF) of kitting bin is combined by a pair of same VF rank such as (A1+A1), (AY+AY) or (AZ+AZ).
3. A Chromaticity Coordinates of kitting bin is mixed by kitting procedure.(below kitting simulation)

[Kitting example]

RU Y	RV	RW	Z ST
RE	RF	RG	SD
RA	RB	RC	S9
R6 W	R7	R8	X S5

[Binning Information]

	Bin #1	Bin #2	Priority
VF	AY	AY	
	AZ	AZ	
	A1	A1	
CIE	W	Z	
	V	V	
	X	Y	
IV	S5	S5	S5↑
	S6	S6	S6↑

※ Each of V,W,X,Y and Z can be one bin without details division.

2) N Kitting Concept

- Under agreement between customer and SAMSUNG ELECTRONICS, SAMSUNG can supply kitting bin (VF, Color, Im).
- A forward voltage (VF) of kitting bin is combined by a pair of same VF rank such as (A1+A1), (AY+AY) or (AZ+AZ). Chromaticity Coordinates of kitting bin is mixed by kitting procedure.(below kitting simulation)

[Kitting example]

RU	RV	RW	ST
RE	RF	RG	SD
RA	RB	RC	S9
R6	R7	R8	S5

[Binning Information]

	Bin #1	Bin #2	Priority
VF	AZ	AZ	
	A1	A1	
	A2	A2	
	A3	A3	
	A4	A4	
CIE	B	G	
	C	F	
IV	S5	S5	S5↑
	S6	S6	S6↑

. ※ Each of V,W,X,Y and Z can be one bin without details division.

3) G Kitting Concept

1. Under agreement between customer and SAMSUNG ELECTRONICS, SAMSUNG can supply kitting bin (VF, Color, Im).
2. A forward voltage (VF) of kitting bin is combined by a pair of same VF rank such as (A1+A1), (AY+AY) or (AZ+AZ).
Chromaticity Coordinates of kitting bin is mixed by kitting procedure.(below kitting simulation)

[Kitting example]

RU	RV	RW	ST
RE	RF	RG	SD
RA	RB	RC	S9
R6	R7	R8	S5

[Binning Information]

	Bin #1	Bin #2	Priority
VF	AY	AY	
	AZ	AZ	
	A1	A1	
CIE	R6	ST	
	R7	RW	
	R8	RV	
	S5	RU	
	RA	SD	
	RB	RG	
	RC	RF	
	S9	RE	
	IV	S5	S5
S6		S6	S6↑

※ Each of V,W,X,Y and Z can be one bin without details division.

c) Color Bins ($I_f = 65 \text{ mA}$, $T_s = 25 \text{ }^\circ\text{C}$)

CRI (R_a) Min.	Nominal CCT (K)	Product Code	Color Rank	Chromaticity Bins
80	5000	SPMWHT541ML5X◆S0S★	S0 (Whole bin)	R6, R7, R8, S5, RA, RB, RC, S9, RE, RF, RG, SD, RU, RV, RW, ST
		SPMWHT541ML5X◆SGS★	SG (S Kitting)	
		SPMWHT541ML5X◆SMS★	SM (Quarter bin)	RB, RC, RF, RG
		SPMWHT541ML5X◆SKS★	SK (K Kitting)	SV, SW, SX, SY, SZ
		SPMWHT541ML5X◆SNS★	SN (N Kitting)	RB, RC, RF, RG

Note:

"◆" can be "A" (2,500pcs) or "K" (10,000pcs) of reel taping

"★" can be "S5" or "S6" of luminous flux bin

d) Voltage Bins ($I_f = 65 \text{ mA}$, $T_s = 25 \text{ }^\circ\text{C}$)

CRI (R_a) Min.	Nominal CCT (K)	Product Code	Voltage Rank	Voltage Bin	Voltage Range (V)
-	-	-	XA	AY	2.6 ~ 2.7
-	-	-		AZ	2.7 ~ 2.8
-	-	-		A1	2.8 ~ 2.9

e) Chromaticity Region & Coordinates ($I_F = 65 \text{ mA}$, $T_s = 25^\circ\text{C}$)

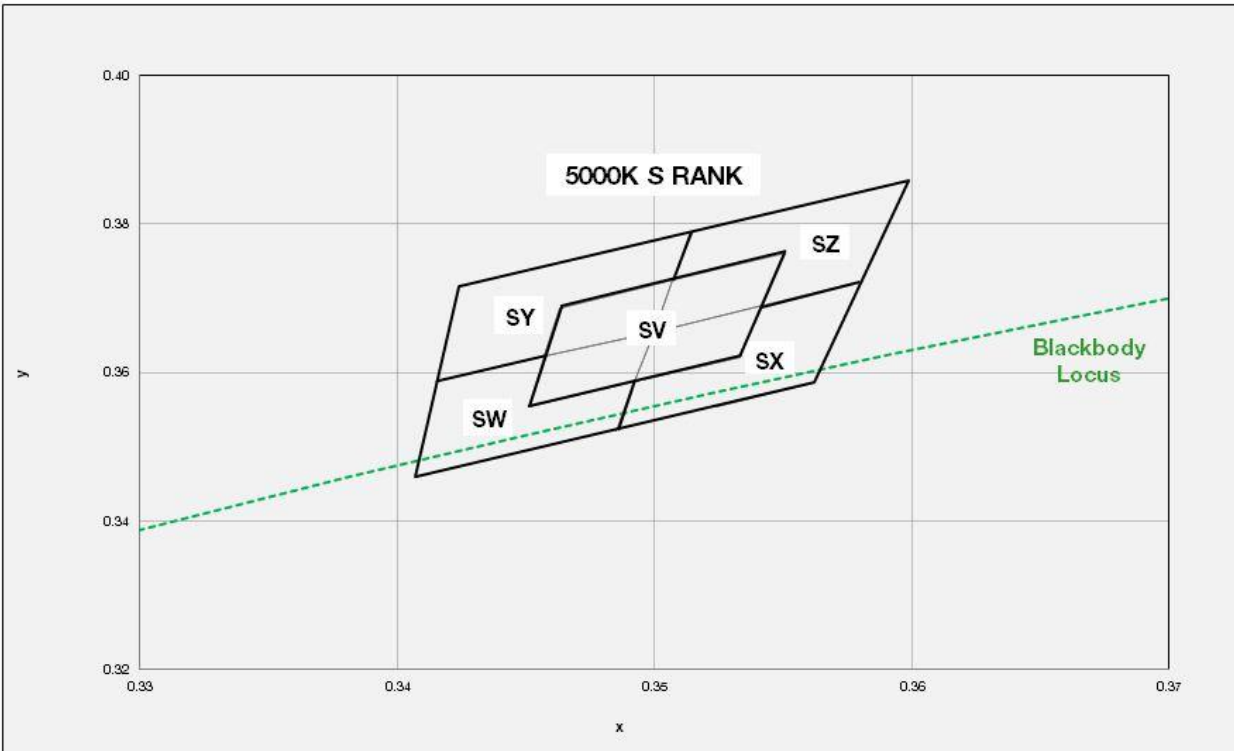

e) Chromaticity Region & Coordinates ($I_f = 65 \text{ mA}$, $T_s = 25 \text{ }^\circ\text{C}$)

Region	CIE x	CIE y	Region	CIE x	CIE y
S rank (5000K)					
R6	0.3407	0.346	RE	0.3415	0.3587
	0.3411	0.3522		0.342	0.3652
	0.3451	0.3554		0.3463	0.3687
	0.3446	0.3491		0.3457	0.3621
R7	0.3446	0.3491	RF	0.3457	0.3621
	0.3451	0.3554		0.3463	0.3687
	0.3492	0.3587		0.3507	0.3724
	0.3485	0.3522		0.35	0.3655
R8	0.3485	0.3522	RG	0.35	0.3655
	0.3492	0.3587		0.3507	0.3724
	0.3533	0.362		0.3551	0.376
	0.3524	0.3554		0.3542	0.369
S5	0.3524	0.3554	SD	0.3542	0.369
	0.3533	0.362		0.3551	0.376
	0.3571	0.3655		0.359	0.3792
	0.3562	0.3586		0.358	0.3723
RA	0.3415	0.3587	RU	0.342	0.3652
	0.3411	0.3522		0.3424	0.3715
	0.3451	0.3554		0.3469	0.3752
	0.3457	0.3622		0.3463	0.3687
RB	0.3451	0.3554	RV	0.3463	0.3687
	0.3457	0.3621		0.3469	0.3752
	0.35	0.3655		0.3515	0.379
	0.3492	0.3587		0.3507	0.3724
RC	0.3492	0.3587	RW	0.3507	0.3724
	0.35	0.3655		0.3515	0.379
	0.3542	0.369		0.356	0.3827
	0.3533	0.362		0.3551	0.376
S9	0.3533	0.362	ST	0.3551	0.376
	0.3542	0.369		0.356	0.3827
	0.358	0.3723		0.3599	0.3859
	0.3571	0.3655		0.359	0.3792

f) Kitting Chromaticity Region & Coordinates

Region	CIE x	CIE y	Region	CIE x	CIE y
S rank (5000 K)					
SV	0.3451	0.3554	SY	0.3415	0.3588
	0.3463	0.3687		0.35	0.3655
	0.3551	0.376		0.3515	0.379
	0.3533	0.362		0.3424	0.3715
SW	0.3407	0.346	SZ	0.358	0.3723
	0.3415	0.3588		0.35	0.3655
	0.35	0.3655		0.3515	0.379
	0.3485	0.3524		0.3599	0.3859
SX	0.3485	0.3524			
	0.35	0.3655			
	0.358	0.3723			
	0.3562	0.3586			

Note:

Samsung maintains measurement tolerance of: $C_x, C_y = \pm 0.005$

3. Typical Characteristics Graphs

a) Spectrum Distribution ($I_f = 65 \text{ mA}$, $T_s = 25 \text{ }^\circ\text{C}$)

CCT: 5000 K (80 CRI)

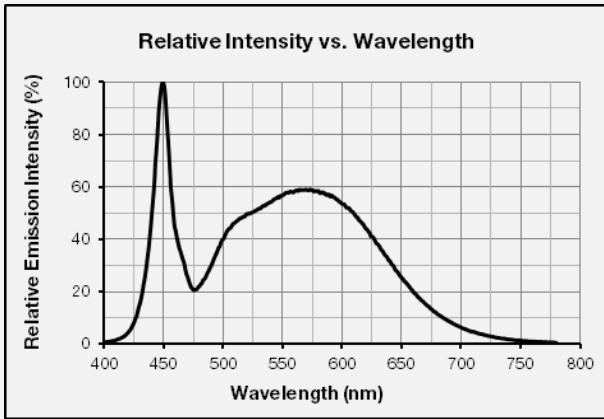

b) Forward Current Characteristics ($T_s = 25 \text{ }^\circ\text{C}$)

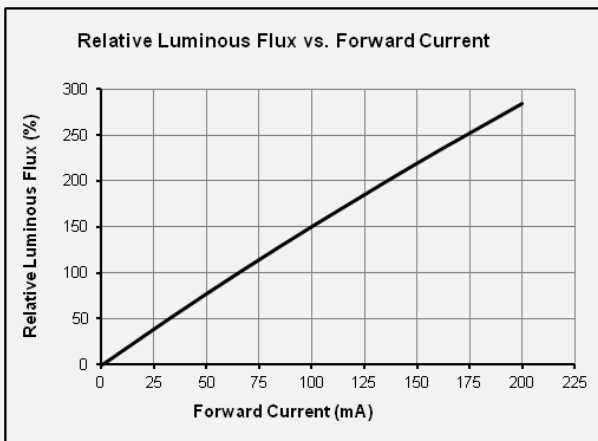

c) Temperature Characteristics ($I_f = 65 \text{ mA}$)



d) Color Shift Characteristics

$T_s = 25^\circ\text{C}$

$I_f = 65\text{ mA}$



e) Derating Curve



f) Beam Angle Characteristics ($I_f = 65\text{ mA}$, $T_s = 25^\circ\text{C}$)



4. Outline Drawing & Dimension

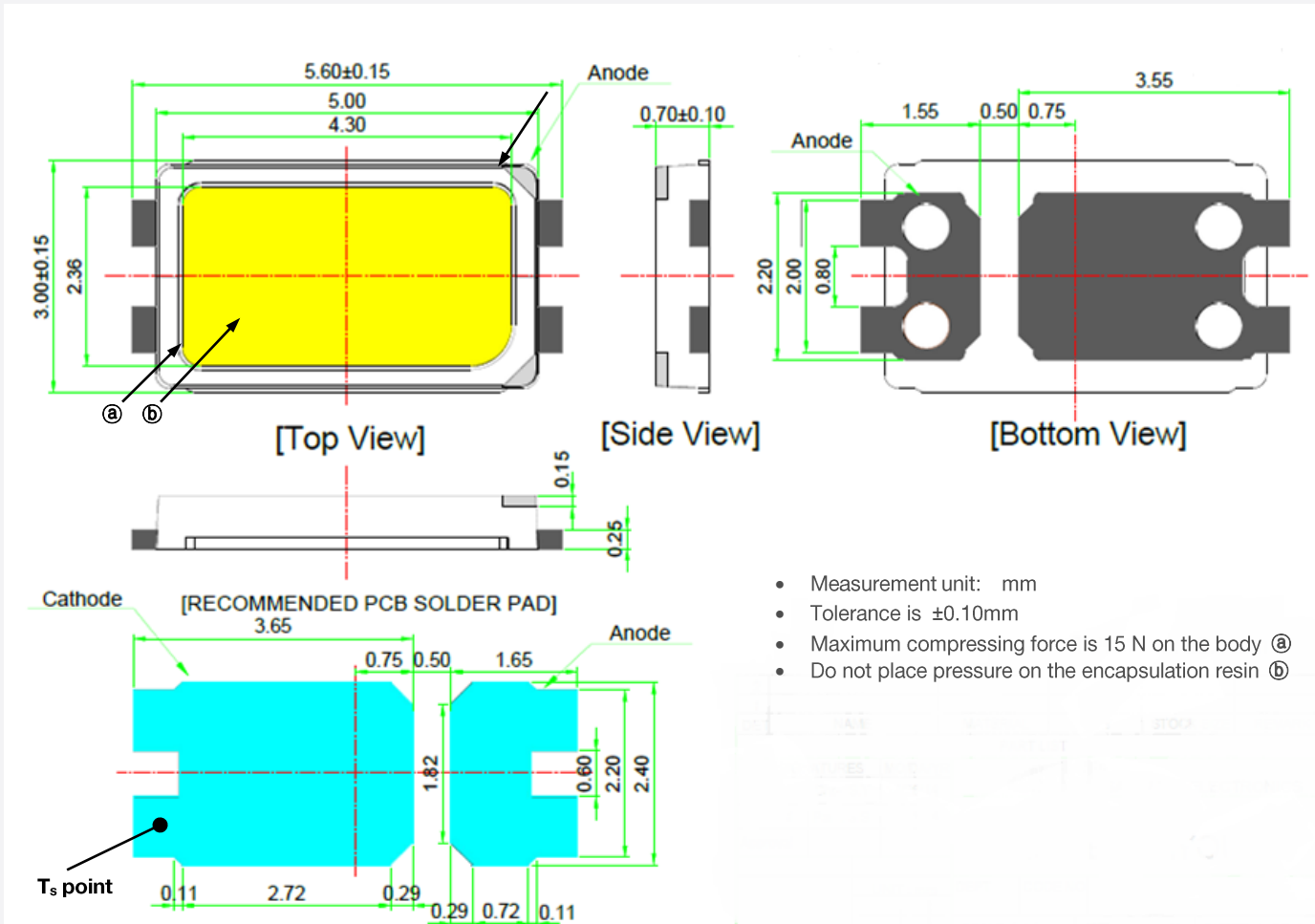

Notes:

- 1) This LED has built-in ESD protection device(s) connected in parallel to LED chip(s).
- 2) T_s point and measurement method:
 - ① Measure one point at the cathode pad, if necessary remove PSR of PCB to reach T_s point.
 - ② All pads must be soldered to the PCB to dissipate heat properly, otherwise the LED can be damaged.

Precautions:

- 1) Pressure on the LEDs will influence to the reliability of the LEDs. Precautions should be taken to avoid strong pressure on the LEDs. Do not put stress on the LEDs during heating.
- 2) Re-soldering should not be done after the LEDs have been soldered. If re-soldering is unavoidable, LED's characteristics should be carefully checked before and after such repair.
- 3) Do not stack assembled PCBs together. Since materials of LEDs is soft, abrasion between two PCB assembled with LED might cause catastrophic failure of the LEDs.

5. Reliability Test Items & Conditions

a) Test Items

Test Item	Test Condition	Test Hour / Cycle	Sample No.
Room Temperature Life Test	25 °C, DC 180 mA	1000 h	22
High Temperature Life Test	85 °C, DC 180 mA	1000 h	22
High Temperature Humidity Life Test	85 °C, 85 % RH, DC 180 mA	1000 h	22
Low Temperature Life Test	-40 °C, DC 180 mA	1000 h	22
Powered Temperature Cycle Test	-45 °C / 20 min ↔ 85 °C / 20 min, sweep 100 min cycle on/off: each 5 min, DC 180 mA	100 cycles	22
Thermal Cycle	-45 °C / 15 min ↔ 125 °C / 15 min → Hot plate 180 °C	500 cycles	100
High Temperature Storage	120 °C	1000 h	11
Low Temperature Storage	-40 °C	1000 h	11
ESD (HBM)		5 times	30
ESD (MM)			
Vibration Test	20~2000~20 Hz, 200 m/s ² , sweep 4 min X, Y, Z 3 direction, each 1 cycle	4 cycles	11
Mechanical Shock Test	1500 g, 0.5 ms 3 shocks each X-Y-Z axis	5 cycles	11

R₁: 10 MΩ
R₂: 1.5 kΩ
C: 100 pF
V: ±5 kV

R₁: 10 MΩ
R₂: 0
C: 200 pF
V: ±0.5 kV

b) Criteria for Judging the Damage

Item	Symbol	Test Condition (T _s = 25 °C)	Limit	
			Min	Max
Forward Voltage	V _F	I _F = 65 mA	Init. Value * 0.9	Init. Value * 1.1
Luminous Flux	Φ _v	I _F = 65 mA	Init. Value * 0.7	Init. Value * 1.1

6. Soldering Conditions

a) Reflow Conditions (Pb free)

Reflow frequency: 2 times max.



b) Manual Soldering Conditions

Not more than 5 seconds @ max. 300 °C, under soldering iron.

7. Tape & Reel

a) Taping Dimension

(unit: mm)

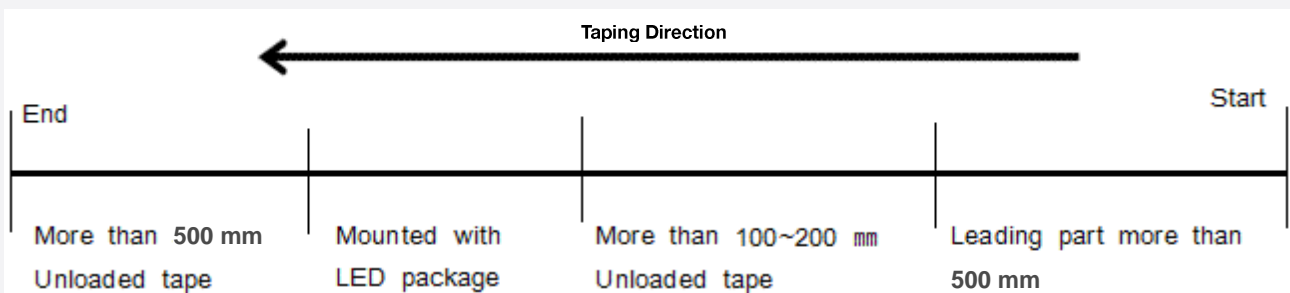

b-1) Reel Dimension (Max 2,500 pcs)

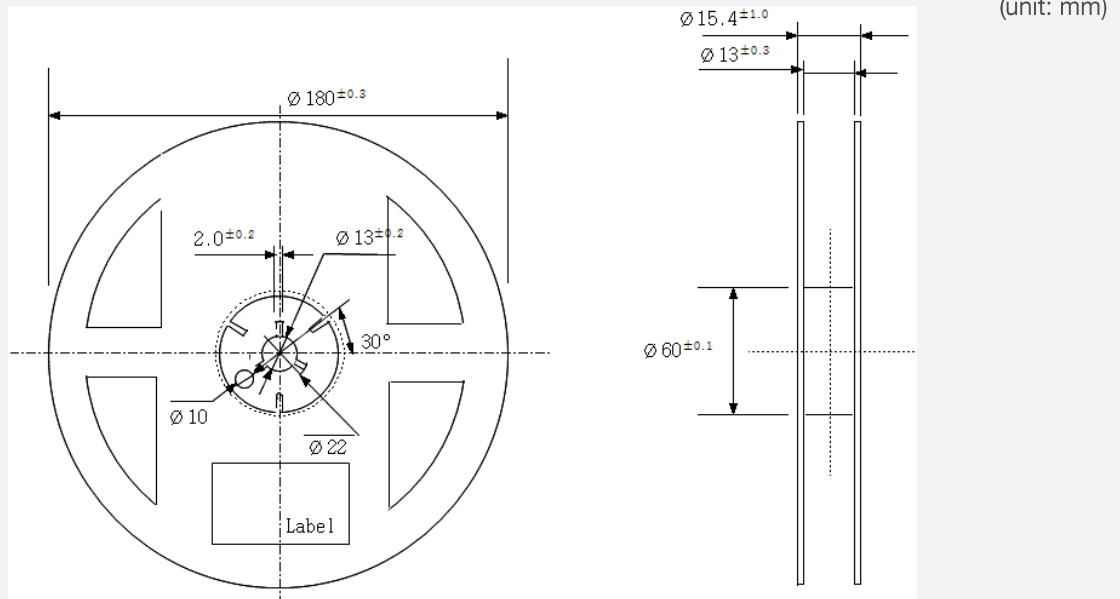

b-2) Reel Dimension (Max 10,000 pcs)



Symbol	A	B	C	W1	W2
Spec(mm)	Ø330±1	80±1	13±0.5	13±0.3	17.5±1

Notes:

- 1) Quantity: The quantity/reel is 2,500 or 10,000 pcs
- 2) Cumulative Tolerance: Cumulative tolerance / 10 pitches is ±0.2 mm
- 3) Adhesion Strength of Cover Tape: Adhesion strength is 0.1-0.7 N when the cover tape is turned off from the carrier tape at 10° angle to the carrier tape
- 4) Packaging: P/N, Manufacturing data code no. and quantity are indicated on the aluminum packing bag

8. Label Structure

a) Label Structure

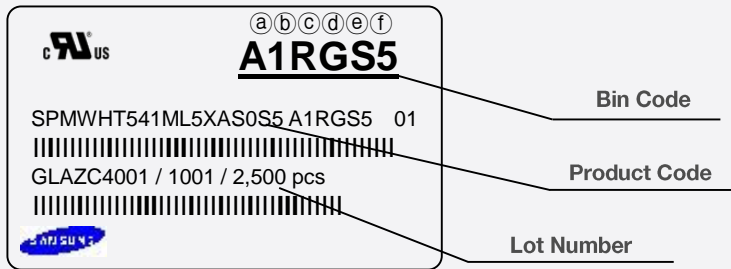

Note: Denoted bin code and product code above is only an example (see description on page 5)

Bin Code:

- ⒶⒷ: Forward Voltage bin (refer to page 10)
- ⒸⒹ: Chromaticity bin (refer to page 11-13)
- ⒺⒻ: Luminous Flux bin (refer to page 6)

b) Lot Number

The lot number is composed of the following characters:

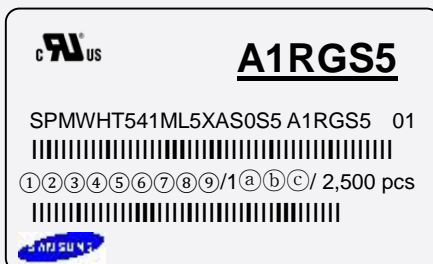

①②③④⑤⑥⑦⑧⑨ / 1ⒶⒷⒸ / 2,500 pcs

- ① : Production site (S: Giheung, Korea, G: Tianjin, China)
- ② : L (LED)
- ③ : Product state (A: Normal, B: Bulk, C: First Production, R: Reproduction, S: Sample)
- ④ : Year (Z: 2015, A: 2016, B: 2017...)
- ⑤ : Month (1~9, A, B, C)
- ⑥⑦⑧⑨ : Day (1~9, A, B~V)
- ⒶⒷⒸ : Product serial number (001 ~ 999)

9. Packing Structure



a-1) Packing Process (The quantity of PKG on the Reel to be Max 2,500pcs)

Reel

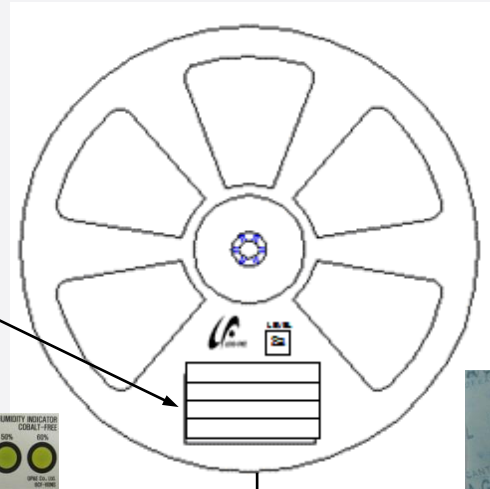
A1RGS5
 SPMWHT541ML5XAS0S5 A1RGS5 01
 GLAZC4001 / 1001 / 2,500 pcs



Aluminum Vinyl Packing Bag



A1RGS5
 SPMWHT541ML5XAS0S5 A1RGS5 01
 GLAZC4001 / 1001 / 2,500 pcs



Outer Box

Material: Paper (SW3B(B))

Type	Size (mm)			Note
	L	W	H	
7 inch L	245 ± 5	220 ± 5	182 ± 5	Up to 10 reels
7 inch S	245 ± 5	220 ± 5	86 ± 5	Up to 5 reels

A1RGS5
 SPMWHT541ML5XAS0S5 A1RGS5 01
 GLAZC4001 / 1001 / 25,000 pcs
 [Box Label]

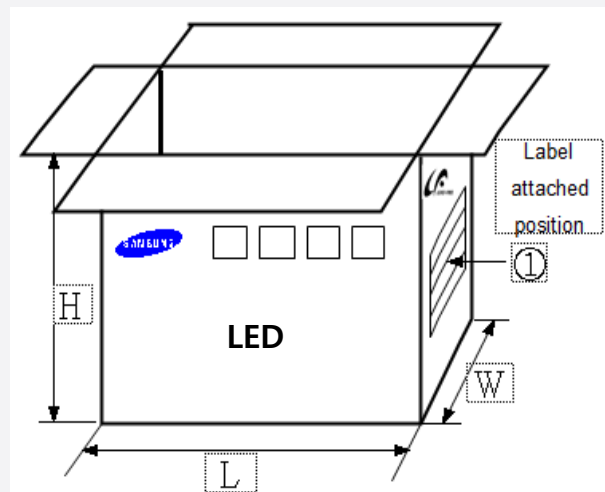

a-2) Packing Process (The quantity of PKG on the Reel to be Max 10,000pcs)

Reel

A1RGS5

SPMWHT541ML5XKS0S5 A1RGS5 01

GLAZC4001 / 1001 / 10,000 pcs

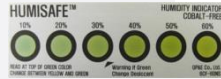
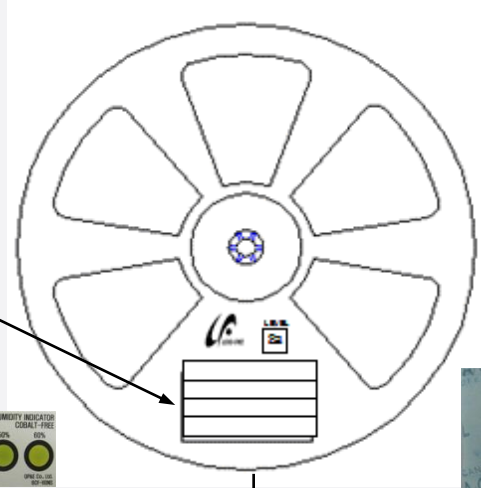

Aluminum Vinyl Packing Bag

A1RGS5

SPMWHT541ML5XKS0S5 A1RGS5 01

GLAZC4001 / 1001 / 10,000 pcs



A1RGS5

SPMWHT541ML5XKS0S5 A1RGS5 01

GLAZC4001 / 1001 / 150,000 pcs

[Box Label]

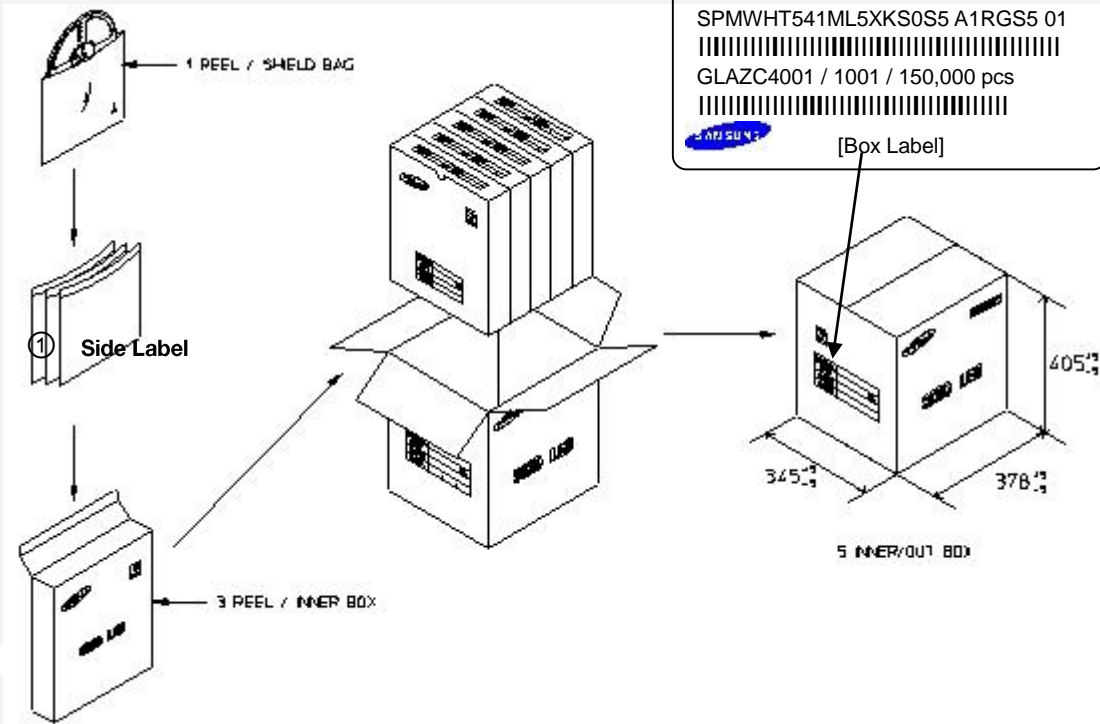

b-1) Packing Process for kitting (The quantity of PKG on the Reel to be Max 2,500pcs)

Reel

Kitting 'A'

CU **US** **A1◇WS5**
 SPMWHT541ML5XA◇KS5 A1◇WS5 01
 GLAW94001 / 1001 / 2,500 pcs

Kitting 'B'

CU **US** **A1◇ZS5**
 SPMWHT541ML5XA◇KS5 A1◇ZS5 01
 GLAW94001 / 1001 / 2,500 pcs



Aluminum Vinyl Packing Bag

Kitting 'A'

CU **US** **A1◇WS5**
 SPMWHT541ML5XA◇KS5 A1◇WS5 01
 GLAW94001 / 1001 / 2,500 pcs

Kitting 'B'

CU **US** **A1◇ZS5**
 SPMWHT541ML5XA◇KS4 A1◇ZS5 01
 GLAW94001 / 1001 / 2,500 pcs



Kitting 'A'

CU **US** **A1◇WS5**
 SPMWHT541ML5XA◇KS5 A1◇WS5 01
 GLAW94001 / 1001 / 2,500 pcs
 [BOX Label]

Kitting 'B'

CU **US** **A1◇ZS5**
 SPMWHT541ML5XA◇KS5 A1◇ZS5 01
 GLAW94001 / 1001 / 2,500 pcs
 [BOX Label]

Note: "◇" can be Nominal CCT code.

Outer Box

Material: Paper (SW3B(B))

Type	Size (mm)			Note
	L	W	H	
7 inch L	245 ± 5	220 ± 5	182 ± 5	Up to 10 reels

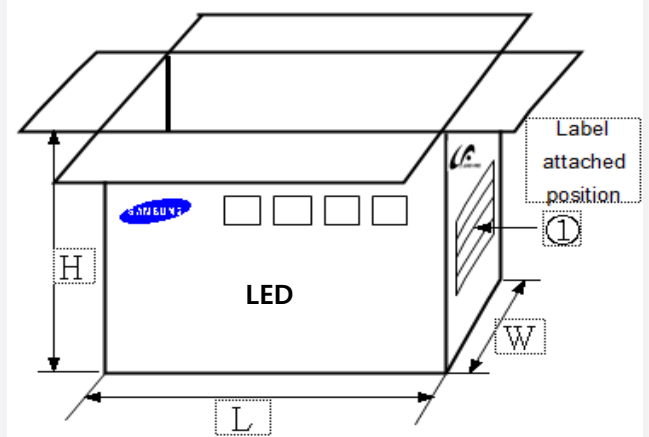

b-2) Packing Process for kitting (The quantity of PKG on the Reel to be Max 10,000pcs)

Reel

Kitting 'A'

US **A1◇WS5**
 SPMWHT541ML5XK◇KS5 A1◇WS5 01
 GLAW94001 / 1001 / 10,000 pcs

Kitting 'B'

US **A1◇ZS5**
 SPMWHT541ML5XK◇KS5 A1◇ZS5 01
 GLAW94001 / 1001 / 10,000 pcs



Aluminum Vinyl Packing Bag

Kitting 'A'

US **A1◇WS5**
 SPMWHT541ML5XK◇KS5 A1◇WS5 01
 GLAW94001 / 1001 / 10,000 pcs

Kitting 'B'

US **A1◇ZS5**
 SPMWHT541ML5XK◇KS5 A1◇ZS5 01
 GLAW94001 / 1001 / 10,000 pcs

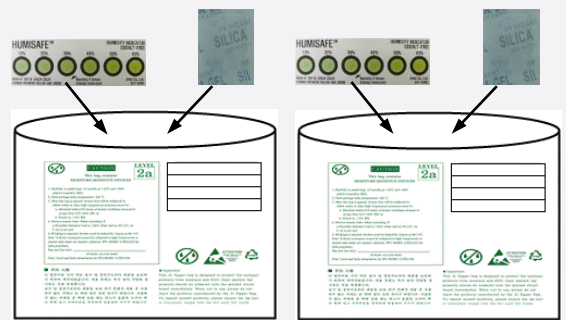

Kitting 'A'

US **A1◇WS5**
 SPMWHT541ML5XK◇KS5 A1◇WS5 01
 GLAW94001 / 1001 / 10,000 pcs
 [BOX Label]

Kitting 'B'

US **A1◇ZS5**
 SPMWHT541ML5XK◇KS5 A1◇ZS5 01
 GLAW94001 / 1001 / 10,000 pcs
 [BOX Label]

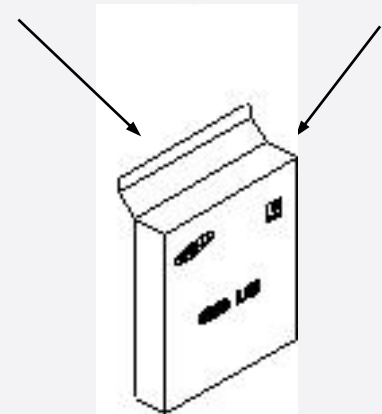

Note: "◇" can be Nominal CCT code.

Outer Box

Material: Paper (SW3B(B))

Type	Size (mm)			Note
	L	W	H	
13 inch L	345 ± 5	378 ± 5	405 ± 5	Up to 10 reels

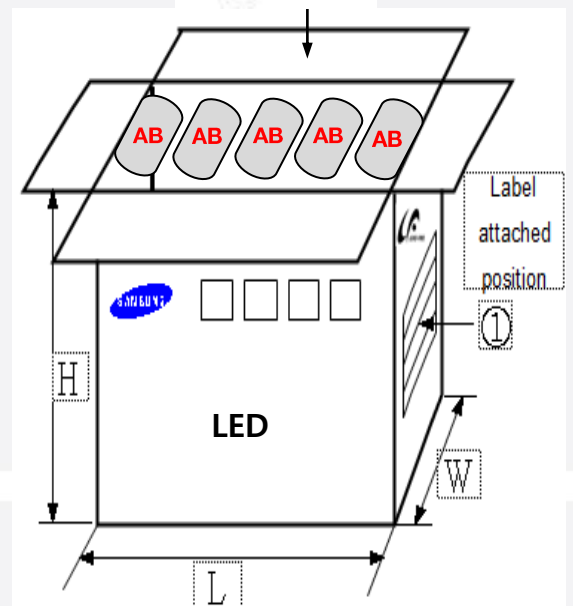

10. Precautions in Handling & Use

- 1) For over-current protection, users are recommended to apply resistors connected in series with the LEDs to mitigate sudden change of the forward current caused by shift of forward voltage.
- 2) This device should not be used in any type of fluid such as water, oil, organic solvent, etc. When cleaning is required, IPA is recommended as the cleaning agent. Some solvent-based cleaning agent may damage the silicone resins used in the device.
- 3) When the device is in operation, the forward current should be carefully determined considering the maximum ambient temperature and corresponding junction temperature.
- 4) LEDs must be stored in a clean environment. If the LEDs are to be stored for three months or more after being shipped from Samsung, they should be packed with a nitrogen-filled container (shelf life of sealed bags is 12 months at temperature 0~40 °C, 0~90 % RH).
- 5) After storage bag is opened, device subjected to soldering, solder reflow, or other high temperature processes must be:
 - a. Mounted within 672 hours (28 days) at an assembly line with a condition of no more than 30 °C / 60 % RH, or
 - b. Stored at <10 % RH
- 6) Repack unused devices with anti-moisture packing, fold to close any opening and then store in a dry place.
- 7) Devices require baking before mounting, if humidity card reading is >60 % at 23 ± 5 °C.
- 8) Devices must be baked for 10~24 hours at 60 ± 5 °C, if baking is required.
- 9) The LEDs are sensitive to the static electricity and surge current. It is recommended to use a wrist band or anti-electrostatic glove when handling the LEDs. If voltage exceeding the absolute maximum rating is applied to LEDs, it may cause damage or even destruction to LED devices. Damaged LEDs may show some unusual characteristics such as increase in leakage current, lowered turn-on voltage, or abnormal lighting of LEDs at low current.
- 10) VOCs (Volatile Organic Compounds) can be generated from adhesives, flux, hardener or organic additives used in luminaires (fixtures). Transparent LED silicone encapsulant is permeable to those chemicals and they may lead to a discoloration of encapsulant when they exposed to heat or light. This phenomenon can cause a significant loss of light emitted (output) from the luminaires. In order to prevent these problems, we recommend users to know the physical properties of materials used in luminaires and they must be carefully selected.
- 11) Risk of sulfurization (or tarnishing)
 The LED from Samsung uses a silver-plated lead frame and its surface color may change to black (or dark colored) when it is exposed to sulfur (S), chlorine (Cl) or other halogen compound. Sulfurization of lead frame may cause intensity degradation, change of chromaticity coordinates and, in extreme cases, open circuit. It requires caution. Due to possible sulfurization of lead frame, LED should not be used and stored together with oxidizing substances made of materials such as rubber, plain paper, lead solder cream, etc.

Legal and additional information.

[About Samsung Electronics Co., Ltd.](#)

Samsung Electronics Co. Ltd inspires the world and shapes the future with transformative ideas and technologies. The company is redefining the worlds of TVs, smartphones, wearable devices, tablets, digital appliances, network systems, and semiconductor and LED solutions. For the latest news, please visit the Samsung Newsroom at <http://news.samsung.com>.

Copyright © 2015 Samsung Electronics Co., Ltd. All rights reserved.
Samsung is a registered trademark of Samsung Electronics Co., Ltd.
Specifications and designs are subject to change without notice. Non-metric weights and measurements are approximate. All data were deemed correct at time of creation. Samsung is not liable for errors or omissions. All brand, product, service names and logos are trademarks and/or registered trademarks of their respective owners and are hereby recognized and acknowledged.

Samsung Electronics Co., Ltd.
95, Samsung 2-ro
Giheung-gu
Yongin-si, Gyeonggi-do, 446-711
KOREA

www.samsungled.com



Looking for pricing, stock, or lifecycle information?

Click below to explore more details on WIN SOURCE:

- ⊖ [View SPMWHT541ML5XASKS6 on WIN SOURCE](#)
- ⊖ [Samsung Information](#)

Optimize Your Supply Chain with WIN SOURCE Solutions

- ✓ Global Sourcing Solution
- ✓ Obsolete Management
- ✓ Cost Control Management
- ✓ Shortage Management
- ✓ Alternative Solution
- ✓ Excess Inventory Management