



**THE DATASHEET OF
SCP9TTJ5HEL1TLJF6E**



High Power LED Series Chip Scale Package

LH231B



Use of Samsung's Chip Scale Package technology
provide high performance and energy conserving



Features & Benefits

- Utilizes Samsung TF chip technology
- Suitable for use in indoor and outdoor lighting
- Operates at a maximum current of up to 2.0 A
- Compact footprint (2.80 x 2.80 mm)

Applications

- Indoor Lighting: Spotlight, Downlight, MR, PAR
- Outdoor Lighting: Street Light, Tunnel Light, Security Light, Parking Lot Light
- Industrial Lighting: High Bay Light, Low Bay Light
- Consumer Lighting: Torch Light

Table of Contents

| | | | |
|-----|-------------------------------------|-------|----|
| 1. | Characteristics | ----- | 3 |
| 2. | Product Code Information | ----- | 6 |
| 3. | Typical Characteristics Graphs | ----- | 12 |
| 4. | Outline Drawing & Dimension | ----- | 14 |
| 5. | Reliability Test Items & Conditions | ----- | 15 |
| 6. | Soldering Conditions | ----- | 16 |
| 7. | Tape & Reel | ----- | 17 |
| 8. | Label Structure | ----- | 19 |
| 9. | Packing Structure | ----- | 20 |
| 10. | Precautions in Handling & Use | ----- | 23 |

1. Characteristics

a) Absolute Maximum Rating

| Item | Symbol | Rating | Unit | Condition |
|---------------------------------|-----------|------------|---------|-----------|
| Ambient / Operating Temperature | T_a | -40 ~ +105 | °C | Note 1) |
| Storage Temperature | T_{stg} | -40 ~ +125 | °C | - |
| LED Junction Temperature | T_j | 135 | °C | - |
| Forward Current | I_F | 2000 | mA | Note 1) |
| Assembly Process Temperature | - | 260 <10 | °C s | - |
| ESD (HBM) | - | ±2 | kV | - |

Note:

- 1) Refer to the derating curve, '3. Typical Characteristics Graph', for proper driving current that maintained below maximum junction temperature.

b) Electro-optical Characteristics

| Item | Unit | Nominal CCT (K) | Condition | | Value Typ. |
|-----------------------------------|--|--------------------|-----------------------------------|---------------------|---------------|
| | | | I _F (mA) | T _J (°C) | |
| Luminous Flux (Φ _v) | lm | 5000 (70 CRI) | 350 | 85 | 176 |
| | | | 700 | 25 | 365 |
| | | | 700 | 85 | 334 |
| | | | 1050 | 85 | 480 |
| | | | 2000 | 85 | 828 |
| | | | Forward Voltage (V _F) | V | |
| Forward Voltage (V _F) | 700 | 25 | 2.85 | | |
| | 700 | 85 | 2.77 | | |
| | 1050 | 85 | 2.88 | | |
| | 2000 | 85 | 3.12 | | |
| | Thermal Resistance (junction to solder point) | K/W | | | 2 |
| Beam Angle | ° | | | 120 | |

Note:

Samsung maintains measurement tolerance of: luminous flux = ±7%, forward voltage = ±0.1 V

c) Luminous Flux Characteristics (T_s = 85 °C)

| Sorting @ 700 mA (lm) | | | Calculated Minimum Flux ²⁾ (lm) | | | |
|-----------------------|--------------------------|------------|--|----------|-----------|-----------|
| Flux Rank | Flux Range ¹⁾ | Sub Rank | @ 350 mA | @ 700 mA | @ 1050 mA | @ 2000 mA |
| FF | 150 ~210 | FB, GB, HB | 79 | 150 | 216 | 372 |
| GF | 170 ~ 230 | GB, HB, JB | 89 | 170 | 244 | 421 |
| HF | 190 ~250 | HB, JB, KB | 100 | 190 | 273 | 471 |
| JF | 210 ~ 270 | JB, KB, MB | 111 | 210 | 302 | 521 |
| KF | 230 ~ 290 | KB, MB, NB | 121 | 230 | 331 | 570 |
| MF | 250 ~ 310 | MB, NB, PB | 132 | 250 | 359 | 620 |
| NF | 270 ~ 330 | NB, PB, QB | 142 | 270 | 388 | 669 |
| PF | 290 ~ 350 | PB, QB, RB | 153 | 290 | 417 | 719 |
| QF | 310 ~ 370 | QB, RB, SB | 163 | 310 | 446 | 769 |
| RF | 330 ~ 390 | RB, SB, TB | 174 | 330 | 475 | 818 |
| SF | 350 ~ 410 | SB, TB, UB | 184 | 350 | 503 | 868 |
| TF | 370 ~ 430 | TB, UB, VB | 195 | 370 | 532 | 917 |
| UF | 390 ~ 450 | UB, VB, WB | 205 | 390 | 561 | 967 |
| VF | 410 ~ 470 | VB, WB, YB | 216 | 410 | 590 | 1016 |
| WF | 430 ~ 490 | WB, YB, ZB | 226 | 430 | 618 | 1066 |

Notes:

- 1) Samsung maintains measurement tolerance of: luminous flux = $\pm 7\%$, CRI = ± 3
- 2) Calculated minimum flux values are for reference only

2. Product Code Information

| | | | | | | | | | | | | | | | | | |
|----------|----------|----------|----------|----------|----------|----------|----------|----------|-----------|-----------|-----------|-----------|-----------|-----------|-----------|-----------|-----------|
| <u>1</u> | <u>2</u> | <u>3</u> | <u>4</u> | <u>5</u> | <u>6</u> | <u>7</u> | <u>8</u> | <u>9</u> | <u>10</u> | <u>11</u> | <u>12</u> | <u>13</u> | <u>14</u> | <u>15</u> | <u>16</u> | <u>17</u> | <u>18</u> |
| S | C | P | 7 | R | T | J | 5 | H | E | L | 1 | R | ☆ | Q | F | 6 | E |

| Digit | PKG Information | Code | Specification | | | | | | | | | | | | | | | | | | | | | | | | |
|----------|----------------------------|---|---|-------------|--|-------------------|--|---------|-------------------|---------|-------------------|---------|-------------------|---------|-------------------|---------|-------------------|---------|-------------------|---------|-------------------|---------|-------------------|--|-------------------|--|-------------------|
| 1 2 3 | Samsung Chip Scale Package | SCP | | | | | | | | | | | | | | | | | | | | | | | | | |
| 4 | CRI | 7 8 9 | CRI 70 CRI 80 CRI 90 | | | | | | | | | | | | | | | | | | | | | | | | |
| 5 | CCT | W V U T R Q P | 2700K 3000K 3500K 4000K 5000K 5700K 6500K | | | | | | | | | | | | | | | | | | | | | | | | |
| 6 | Chip Shape | T | Square type | | | | | | | | | | | | | | | | | | | | | | | | |
| 7 8 9 | Product | J5H | Chip version | | | | | | | | | | | | | | | | | | | | | | | | |
| 10 11 12 | Product Purpose | EL1 | FEC for lighting | | | | | | | | | | | | | | | | | | | | | | | | |
| 13 14 | CCT (K) | W☆ V☆ U☆ T☆ R☆ Q☆ P☆ | 2700 WU, WL 3000 VU, VL 3500 UU, UL 4000 TU, TL 5000 RU, RL 5700 QU, QL 6500 PU, PL ☆ : "U"(MacAdam 3-step ellipse bin), "L" (MacAdam 5-step ellipse bin) | | | | | | | | | | | | | | | | | | | | | | | | |
| 15 16 | Luminous Flux | FF GF HF JF KF MF NF PF QF | <table border="0"> <tr> <td>150-210</td><td>FB 150-170</td><td rowspan="14"> </td></tr> <tr> <td>170-230</td><td>GB 170-190</td></tr> <tr> <td>190-250</td><td>HB 190-210</td></tr> <tr> <td>210-270</td><td>JB 210-230</td></tr> <tr> <td>230-290</td><td>KB 230-250</td></tr> <tr> <td>250-310</td><td>MB 250-270</td></tr> <tr> <td>270-330</td><td>NB 270-290</td></tr> <tr> <td>290-350</td><td>PB 290-310</td></tr> <tr> <td>310-370</td><td>QB 310-330</td></tr> <tr> <td></td><td>RB 330-350</td></tr> <tr> <td></td><td>SB 350-370</td></tr> </table> | | 150-210 | FB 150-170 | | 170-230 | GB 170-190 | 190-250 | HB 190-210 | 210-270 | JB 210-230 | 230-290 | KB 230-250 | 250-310 | MB 250-270 | 270-330 | NB 270-290 | 290-350 | PB 290-310 | 310-370 | QB 310-330 | | RB 330-350 | | SB 350-370 |
| 150-210 | FB 150-170 | | | | | | | | | | | | | | | | | | | | | | | | | | |
| 170-230 | GB 170-190 | | | | | | | | | | | | | | | | | | | | | | | | | | |
| 190-250 | HB 190-210 | | | | | | | | | | | | | | | | | | | | | | | | | | |
| 210-270 | JB 210-230 | | | | | | | | | | | | | | | | | | | | | | | | | | |
| 230-290 | KB 230-250 | | | | | | | | | | | | | | | | | | | | | | | | | | |
| 250-310 | MB 250-270 | | | | | | | | | | | | | | | | | | | | | | | | | | |
| 270-330 | NB 270-290 | | | | | | | | | | | | | | | | | | | | | | | | | | |
| 290-350 | PB 290-310 | | | | | | | | | | | | | | | | | | | | | | | | | | |
| 310-370 | QB 310-330 | | | | | | | | | | | | | | | | | | | | | | | | | | |
| | RB 330-350 | | | | | | | | | | | | | | | | | | | | | | | | | | |
| | SB 350-370 | | | | | | | | | | | | | | | | | | | | | | | | | | |
| | | | Digit 15: Min. spec Digit 16: The number of higher bin(s) from min. spec. e.g.: KB = 230~250 lm, KF = 230~290 lm | | | | | | | | | | | | | | | | | | | | | | | | |
| 17 18 | Forward Voltage (Vf) | | 6E | 2.7 ~ 3.1 V | Bin Code 6A 2.7~2.9V AE 2.9~3.1V | | | | | | | | | | | | | | | | | | | | | | |

a) Luminous Flux Bins ($I_F = 700 \text{ mA}$, $T_s = 85 \text{ °C}$)

| CRI/ Nominal CCT (K) | Flux rank | | | | | | | | | | | | |
|-------------------------|-----------|-----|--------------------|--------------------|-----|-----|-----|--------------------|--------------------|--------------------|-----|-----|--|
| | FB | GB | HB | JB | KB | MB | NB | PB | QB | RB | SB | TB | |
| (min. flux) | 150 | 170 | 190 | 210 | 230 | 250 | 270 | 290 | 310 | 330 | 350 | 370 | |
| 70 | 2700 | | | | | | | SCP7WTJ5HEL1W☆MF6E | | | | | |
| | 3000 | | | | | | | | SCP7VTJ5HEL1V☆PF6E | | | | |
| | 3500 | | | | | | | | SCP7UTJ5HEL1U☆PF6E | | | | |
| | 4000 | | | | | | | | | SCP7TTJ5HEL1T☆QF6E | | | |
| | 5000 | | | | | | | | | SCP7RTJ5HEL1R☆QF6E | | | |
| | 5700 | | | | | | | | | SCP7QTJ5HEL1Q☆QF6E | | | |
| | 6500 | | | | | | | | | SCP7PTJ5HEL1P☆PF6E | | | |
| 80 | 2700 | | | | | | | SCP8WTJ5HEL1W☆MF6E | | | | | |
| | 3000 | | | | | | | | SCP8VTJ5HEL1V☆NF6E | | | | |
| | 3500 | | | | | | | | SCP8UTJ5HEL1U☆NF6E | | | | |
| | 4000 | | | | | | | | | SCP8TTJ5HEL1T☆PF6E | | | |
| | 5000 | | | | | | | | | SCP8RTJ5HEL1R☆PF6E | | | |
| | 5700 | | | | | | | | | SCP8QTJ5HEL1Q☆PF6E | | | |
| | 6500 | | | | | | | | | SCP8PTJ5HEL1P☆NF6E | | | |
| 90 | 2700 | | SCP9WTJ5HEL1W☆HF6E | | | | | | | | | | |
| | 3000 | | | SCP9VTJ5HEL1V☆JF6E | | | | | | | | | |
| | 3500 | | | SCP9UTJ5HEL1U☆JF6E | | | | | | | | | |
| | 4000 | | | SCP9TTJ5HEL1T☆JF6E | | | | | | | | | |

“☆” can be “L” (MacAdam 5-step ellipse bin), “U” (MacAdam 3-step ellipse bin) of the color binning

b) Color Bins ($I_f = 700 \text{ mA}$, $T_s = 85 \text{ °C}$)

| Nominal CCT (K) | CRI (R_a) | Color Rank | Chromaticity Bins |
|---|---------------|--|-------------------|
| 2700, 3000, 3500, 4000, 5000, 5700, 6500 | 70 | | |
| 2700, 3000, 3500, 4000, 5000, 5700, 6500 | 80 | U (MacAdam 3-Step) L (MacAdam 5-Step) | ☆U, ☆L |
| 2700, 3000, 3500, 4000 | 90 | | |

Notes:

1) ☆ : Nominal CCT code, W(2700K)/V(3000K)/U(3500K)/T(4000K)/R(5000K)/Q(5700K)/P(6500K)

c) Voltage Bins ($I_F = 700 \text{ mA}$, $T_s = 85 \text{ °C}$)

| CRI (Ra) | Nominal CCT (K) | Product Code | Voltage Rank | Voltage Bin | Voltage Range (V) |
|----------|-----------------|--------------|--------------|-------------|-------------------|
| | | | 6E | 6A | 2.7 ~ 2.9 |
| | | | | AE | 2.9 ~ 3.1 |

d) Chromaticity Region & Coordinates ($I_f = 700 \text{ mA}$, $T_s = 85 \text{ }^\circ\text{C}$)

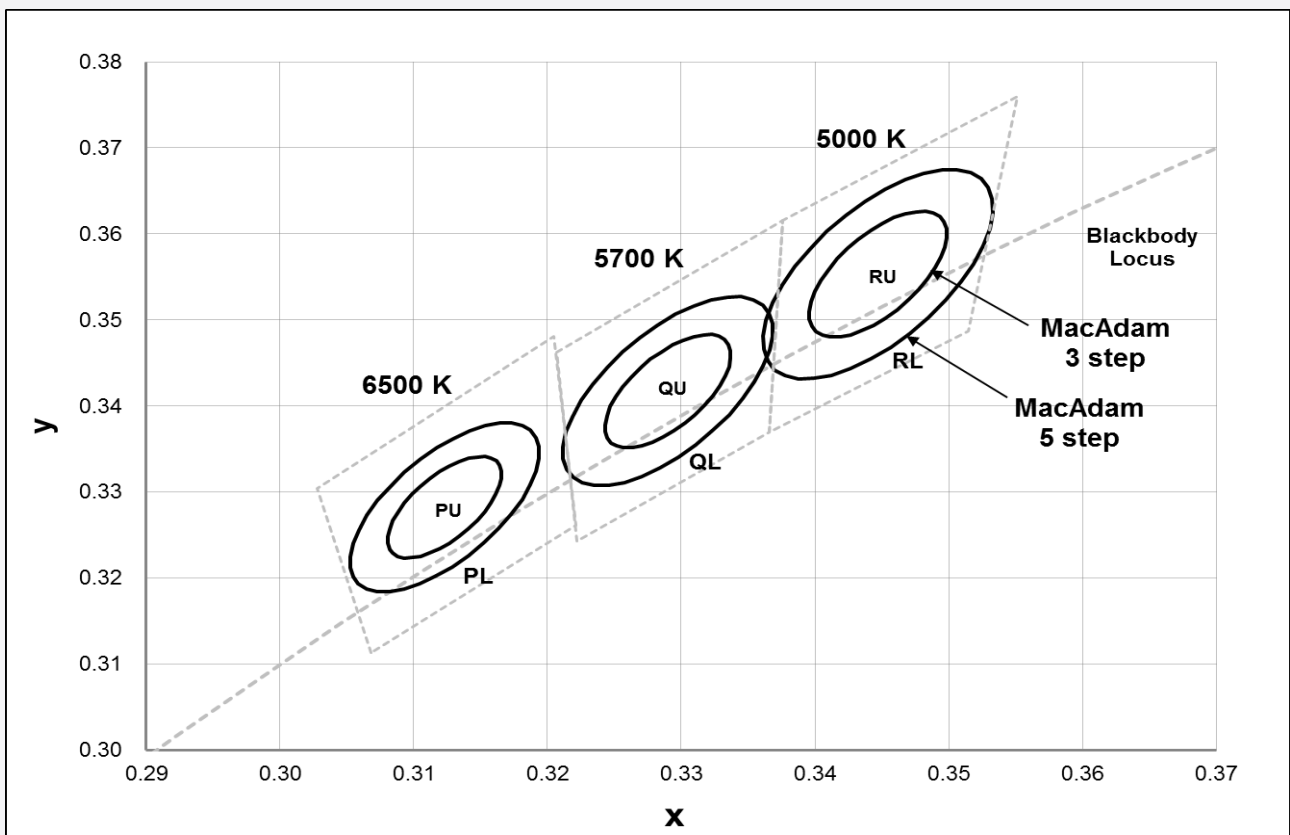

e) Chromaticity Region & Coordinates ($I_F = 700 \text{ mA}$, $T_s = 85 \text{ }^\circ\text{C}$)

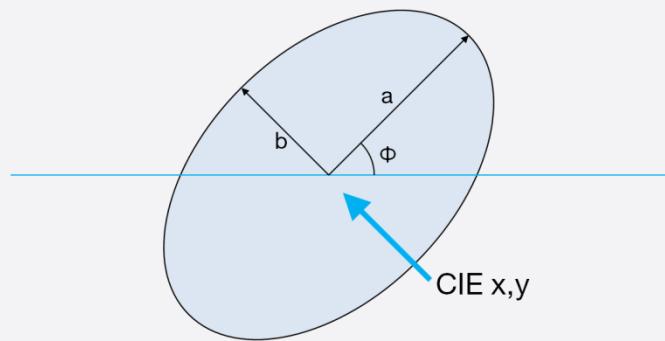

| | CCT (K) | Center point | | Major-axis | Minor-axis | Rotation |
|--------|---------|--------------|--------|------------|------------|----------|
| | | CIE x | CIE y | a | b | Φ |
| 3 step | 2700 | 0.4578 | 0.4101 | 0.0081 | 0.0042 | 53.70 |
| | 3000 | 0.4338 | 0.4030 | 0.0083 | 0.0041 | 53.22 |
| | 3500 | 0.4073 | 0.3917 | 0.0093 | 0.0041 | 54.00 |
| | 4000 | 0.3818 | 0.3797 | 0.0094 | 0.0040 | 53.72 |
| | 5000 | 0.3447 | 0.3553 | 0.0082 | 0.0035 | 59.62 |
| | 5700 | 0.3287 | 0.3417 | 0.0075 | 0.0032 | 59.10 |
| | 6500 | 0.3123 | 0.3282 | 0.0067 | 0.0029 | 58.57 |
| 5 step | 2700 | 0.4578 | 0.4101 | 0.0135 | 0.0070 | 53.70 |
| | 3000 | 0.4338 | 0.4030 | 0.0138 | 0.0068 | 53.22 |
| | 3500 | 0.4073 | 0.3917 | 0.0155 | 0.0068 | 54.00 |
| | 4000 | 0.3818 | 0.3797 | 0.0157 | 0.0067 | 53.72 |
| | 5000 | 0.3447 | 0.3553 | 0.0137 | 0.0058 | 59.62 |
| | 5700 | 0.3287 | 0.3417 | 0.0125 | 0.0053 | 59.10 |
| | 6500 | 0.3123 | 0.3282 | 0.0112 | 0.0048 | 58.57 |

Note:

Samsung maintains measurement tolerance of: $C_x, C_y = \pm 0.005$

3. Typical Characteristics Graphs

a) Spectrum Distribution ($I_F = 700 \text{ mA}$, $T_s = 85 \text{ }^\circ\text{C}$)

3000K/CRI70

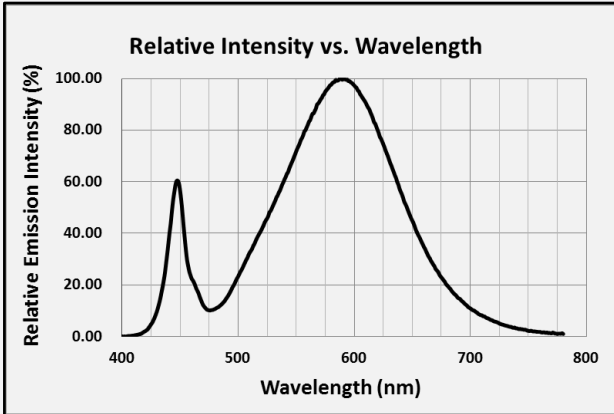

5000K/CRI70

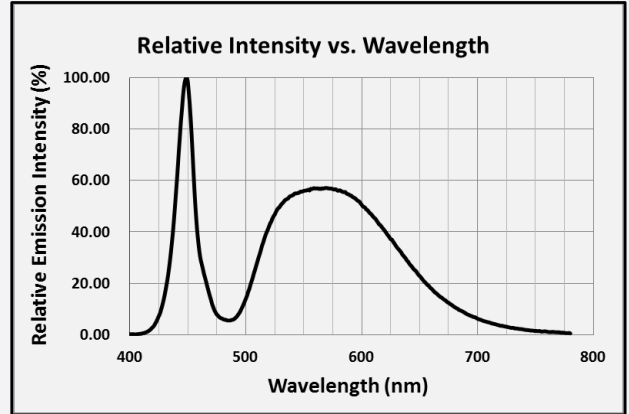

b) Forward Current Characteristics ($T_s = 85 \text{ }^\circ\text{C}$)

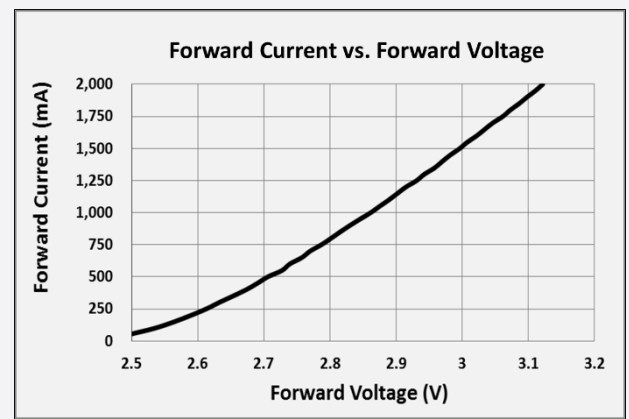

c) Temperature Characteristics ($I_F = 700 \text{ mA}$)

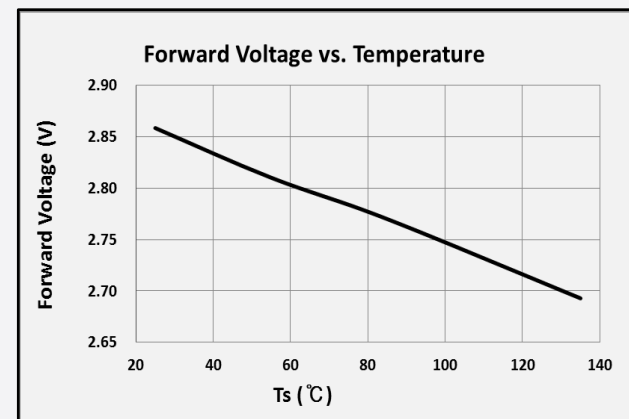

d) Color Shift Characteristics ($I_F = 700 \text{ mA}$, $T_s = 85 \text{ }^\circ\text{C}$)

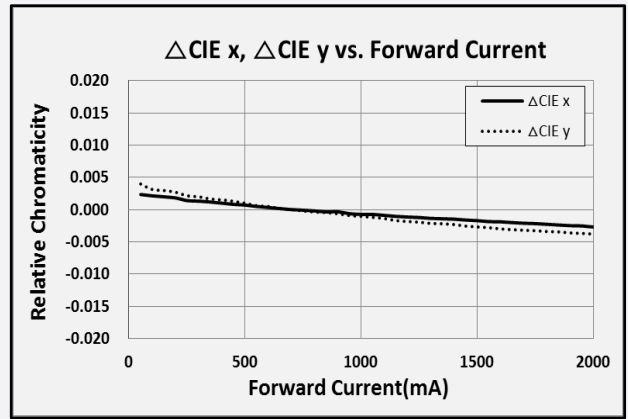

e) Derating Curve and Beam Angle Characteristics ($I_F = 700 \text{ mA}$, $T_s = 25 \text{ }^\circ\text{C}$)

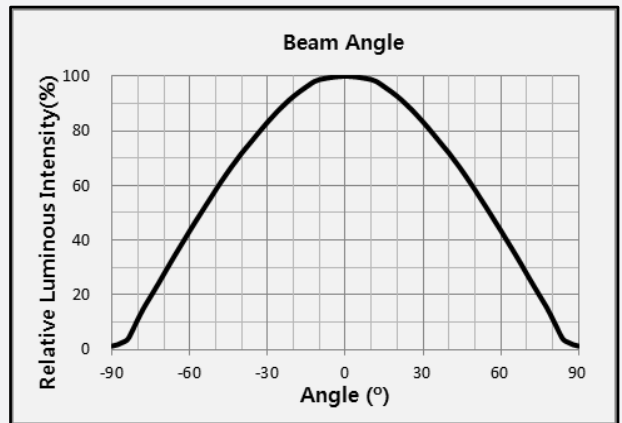

4. Outline Drawing & Dimension



- Measurement unit: mm
- Tolerance: ± 0.13 mm

Precautions:

- 1) Pressure on the LEDs will influence to the reliability of the LEDs. Precautions should be taken to avoid strong pressure on the LEDs. Do not put stress on the LEDs during heating.
- 2) Re-soldering should not be done after the LEDs have been soldered. If re-soldering is unavoidable, LED's characteristics should be carefully checked before and after such repair.
- 3) Do not stack assembled PCBs together. Since materials of LEDs is soft, abrasion between two PCB assembled with LED might cause catastrophic failure of the LEDs.

5. Reliability Test Items & Conditions

a) Test Items

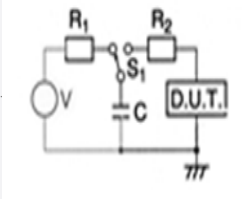
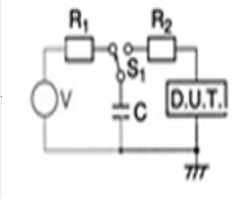
| Test Item | Test Condition | Test Hour / Cycle |
|-------------------------------------|--|-------------------|
| High Temperature Life Test | 85 °C, Derating maximum current | 1000 h |
| High Temperature Humidity Life Test | 85 °C, 85% RH, Derating maximum current | 1000 h |
| Temperature Humidity Cycle Test | -10°C ↔ 25°C/Dry, 25°C ↔ 65°C 95% R.H. Derating maximum current | 10 cycles |
| Thermal Shock | -45 °C / 15 min ↔ 125 °C / 15 min temperature change within 5 min | 700 cycles |
| High Temperature Storage | 125 °C | 1000 h |
| Low Temperature Storage | -40 °C | 1000 h |
| ESD (HBM) |  <p> R_1: 10 MΩ R_2: 1.5 kΩ C: 100 pF V: ± 2 kV </p> | 5 times |
| ESD (MM) |  <p> R_1: 10 MΩ R_2: 0 C: 200 pF V: ± 0.2 kV </p> | 5 times |
| Vibration Test | 20~2000~20 Hz, 200 m/s ² , sweep 4 min X, Y, Z 3 direction, each 1 cycle | 4 cycles |
| Mechanical Shock Test | 1500 g, 0.5 ms 3 shocks each X-Y-Z axis | 5 cycles |

b) Criteria for Judging the Damage

| Item | Symbol | Test Condition ($T_s = 25$ °C) | Limit | |
|-----------------|----------|------------------------------------|-------------------|-------------------|
| | | | Min. | Max. |
| Forward Voltage | V_F | $I_F = 700$ mA | Init. Value * 0.9 | Init. Value * 1.1 |
| Luminous Flux | Φ_v | $I_F = 700$ mA | Init. Value * 0.7 | Init. Value * 1.1 |

6. Soldering Conditions

a) Reflow Conditions (Pb free)

Reflow frequency: 2 times max.

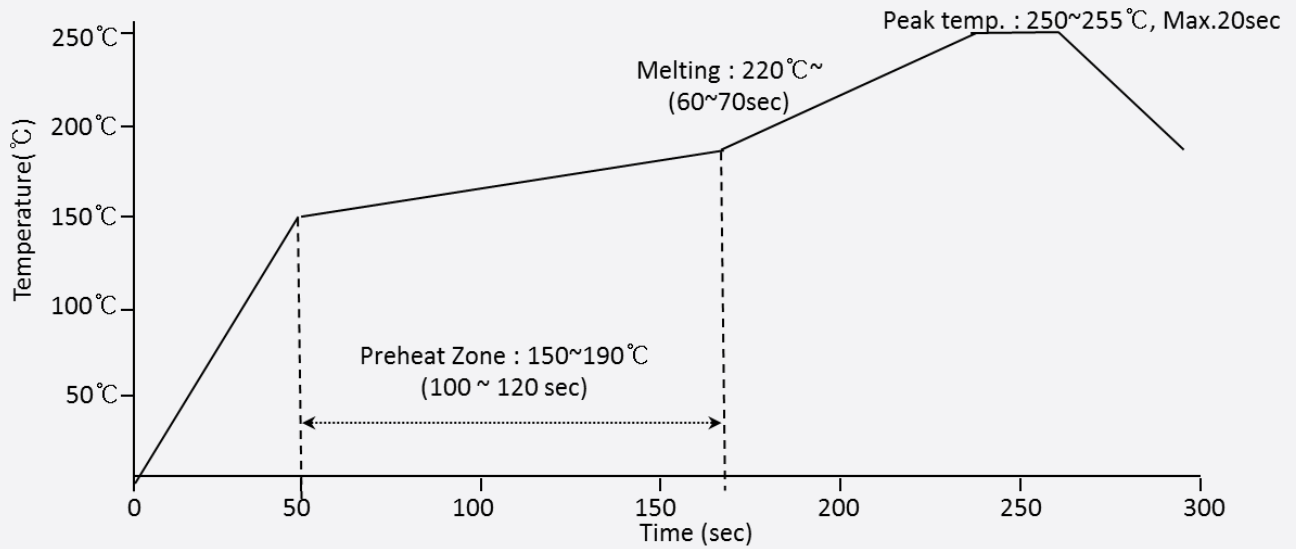

b) Manual Soldering Conditions

No more than 5 seconds @ max. 300 °C, under soldering iron.

b) Reel Dimension

(unit: mm)

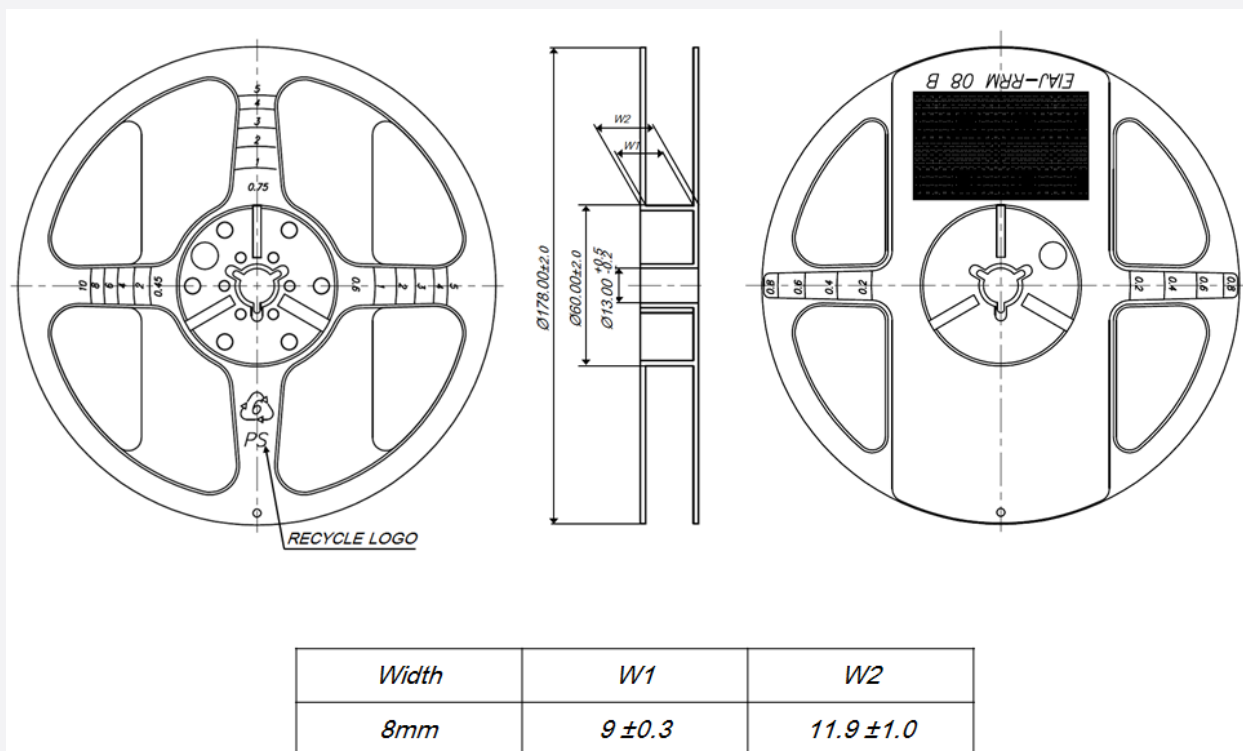
**Notes:**

- 1) Quantity: The quantity/reel is 2,000 pcs
- 2) Cumulative tolerance: Cumulative tolerance / 10 pitches is ± 0.2 mm
- 3) Adhesion strength of cover tape: Adhesion strength is 0.1-0.7 N when the cover tape is turned off from the carrier tape at 10° angle to the carrier tape
- 4) Packaging: P/N, Manufacturing data code no. and quantity are indicated on the aluminum packing bag

8. Label Structure

a) Label Structure



Note: Denoted Bin ID and product code above is only an example

Rank Code:

- ⒶⒷ: Chromaticity bin (refer to page 6)
- ⒸⒹ: Luminous Flux bin (refer to page 6,7)
- ⒺⒻ: Voltage bin (refer to page 6,9)

b) Lot Number

The lot number is composed of the following characters:

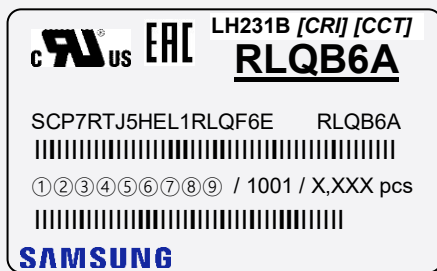

- ① : T (T: Taping ID)
- ② : 1 (1: LED Manufacture Line)
- ③ : Year (G:2016, H: 2017, ...)
- ④ : Month (1, 2, ..., 7: July, ..., A: Oct., B: Nov., C: Dec.)
- ⑤ : Day (1~9, A: 10, ..., K: 20, ..., U: 30, V:31)
- ⑥⑦⑧⑨ : Product serial number (0001 ~ 9999)

9. Packing Structure

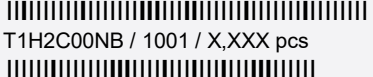

a) Packing Process

Reel

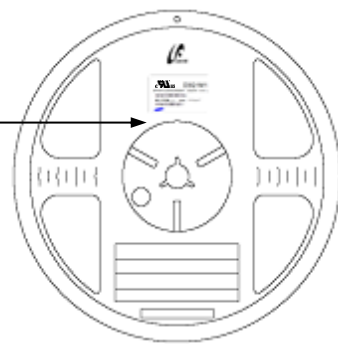

 LH231B [CRI] [CCT]
RLQB6A
 SCP7RTJ5HEL1RLQF6E RLQB6A
 T1H2C00NB / 1001 / X,XXX pcs

SAMSUNG

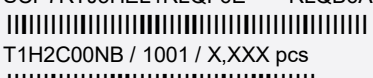

Aluminum Vinyl Packing Bag





 LH231B [CRI] [CCT]
RLQB6A
 SCP7RTJ5HEL1RLQF6E RLQB6A
 T1H2C00NB / 1001 / X,XXX pcs

SAMSUNG

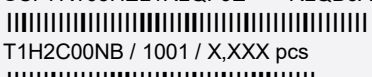

Outer Box

Material: Paper SW(B)

| Type | Size (mm) | | | Note |
|--------|-----------|---------|---------|---------------|
| | (a) | (b) | (c) | |
| 7 inch | 245 ± 5 | 220 ± 5 | 182 ± 5 | Up to 7 reels |

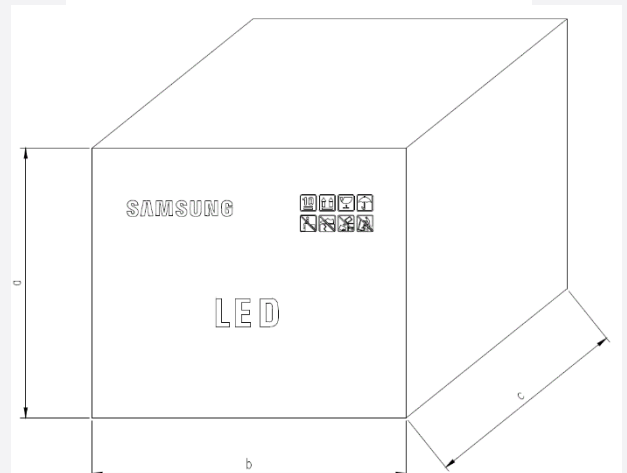

 LH231B [CRI] [CCT]
RLQB6A
 SCP7RTJ5HEL1RLQF6E RLQB6A
 T1H2C00NB / 1001 / X,XXX pcs

SAMSUNG



b) Aluminum Vinyl Packing Bag



CAUTION

This bag contains
MOISTURE SENSITIVE DEVICES

LEVEL
2a

1. Shelf life in sealed bag: 12 months at <math>< 40^{\circ}\text{C}</math> and <math>< 90\%</math> relative humidity (RH)
2. Peak package body temperature: 240 °C
3. After this bag is opened, devices that will be subjected to reflow solder or other high temperature processes must be:
 - a. Mounted within 672 hours at factory conditions of equal to or less than 30°C / 60% RH, or
 - b. Stored at <math>< 10\%</math> RH
4. Devices require bake, before mounting, if:
 - a. Humidity Indicator Card is > 65% when read at 23±5°C, or
 - b. 2a is not met.
5. If baking is required, devices must be baked for 1 hours at 60±5°C

Note: If device containers cannot be subjected to high temperature or shorter bake times are desired, reference IPC/JEDEC J-STD-033 for bake procedure.

Bag seal due date: _____
(if blank, see code label)

Note: Level and body temperature by IPC/JEDEC J-STD-020



LH231B [CRI] [CCT]
RLQB6A

SCP7RTJ5HEL1RLQF6E RLQB6A
T1H2C00NB / 1001 / X,XXX pcs

SAMSUNG



ATTENTION
OBSERVE PRECAUTIONS
FOR HANDLING
ELECTROSTATIC
SENSITIVE
DEVICES



주의 사항

이 알루미늄 지퍼 팩은 습기 및 정전기로부터 제품을 보호하기 위하여 제작되었습니다. 개봉 후에는 즉시 솔더 작업을 실시하는 것을 권장합니다.

습기 및 정전기로부터 제품을 보호 하기 위해서 개봉 후 사용하지 않는 자재는 본 팩에 넣어 보관 하시기 바랍니다. 사용하지 않는 자재를 본 팩에 넣을 때는 반드시 동봉된 드라이 팩과 함께 넣고 지퍼부분을 완전하게 밀봉하여 주시기 바랍니다.

Important

This Al Zipper bag is designed to protect the enclosed products from moisture and ESD. Once opened, the products should be soldered onto the printed circuit board immediately. When not in use, please do not leave the products unprotected by the Al Zipper Bag. To repack unused products., please ensure the zip-lock is completely sealed with the dry pack left inside.

c) Silica Gel & Humidity Indicator Card inside Aluminum Vinyl Bag

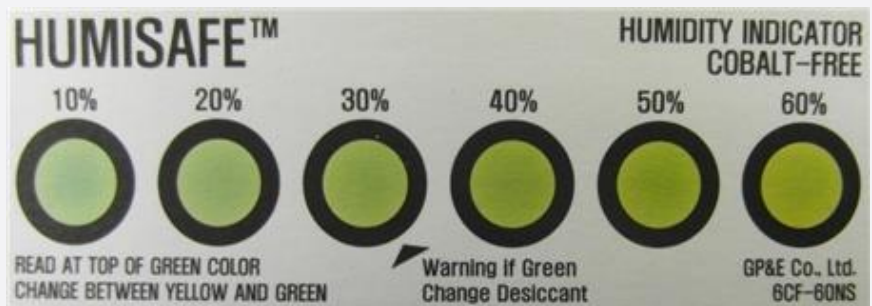

10. Precautions in Handling & Use

- 1) For over-current protection, users are recommended to apply resistors connected in series with the LEDs to mitigate sudden change of the forward current caused by shift of forward voltage.
- 2) This device should not be used in any type of fluid such as water, oil, organic solvent, etc. When cleaning is required, IPA is recommended as the cleaning agent. Some solvent-based cleaning agent may damage the silicone resins used in the device.
- 3) When the device is in operation, the forward current should be carefully determined considering the maximum ambient temperature and corresponding junction temperature.
- 4) LEDs must be stored in a clean environment.
- 5) After storage bag is opened, device subjected to soldering, solder reflow, or other high temperature processes must be:
 - a. Mounted within 672 hours (28 days) at an assembly line with a condition of no more than 30 °C / 60 % RH, or
 - b. Stored at <10 % RH
- 6) Repack unused devices with anti-moisture packing, fold to close any opening and then store in a dry place.
- 7) Devices require baking before mounting, if humidity card reading is >60 % at 23 ± 5 °C.
- 8) Devices must be baked for 1 hour at 60 ± 5 °C, if baking is required.
- 9) The LEDs are sensitive to the static electricity and surge current. It is recommended to use a wrist band or anti-electrostatic glove when handling the LEDs. If voltage exceeding the absolute maximum rating is applied to LEDs, it may cause damage or even destruction to LED devices. Damaged LEDs may show some unusual characteristics such as increase in leakage current, lowered turn-on voltage, or abnormal lighting of LEDs at low current.
- 10) VOCs (Volatile Organic Compounds) can be generated from adhesives, flux, hardener or organic additives used in luminaires (fixtures). Transparent LED silicone encapsulant is permeable to those chemicals and they may lead to a discoloration of encapsulant when they exposed to heat or light. This phenomenon can cause a significant loss of light emitted (output) from the luminaires. In order to prevent these problems, we recommend users to know the physical properties of materials used in luminaires and they must be carefully selected.
- 11) Risk of sulfurization (or tarnishing)

The LED from Samsung does not use a silver-plated lead frame but if the LED is attached in silver-plated substrate, the surface color of substrate may change to black (or dark colored) when it is exposed to sulfur (S), chlorine (Cl) or other halogen compound. Sulfurization of substrate may cause intensity degradation, change of chromaticity coordinates and, in extreme cases, open circuit, It requires caution. Due to possible sulfurization of substrate, LED should not be used and stored together with oxidizing substances made of materials such as rubber, plain paper, lead solder cream, etc.

Legal and additional information.

[About Samsung Electronics Co., Ltd.](#)

Samsung inspires the world and shapes the future with transformative ideas and technologies.

The company is redefining the worlds of TVs, smartphones, wearable devices, tablets, digital appliances, network systems, and memory, system LSI, foundry and LED solutions. For the latest news, please visit the Samsung Newsroom at news.samsung.com.

Copyright © 2020 Samsung Electronics Co., Ltd. All rights reserved.

Samsung is a registered trademark of Samsung Electronics Co., Ltd.

Specifications and designs are subject to change without notice. Non-metric weights and measurements are approximate. All data were deemed correct at time of creation. Samsung is not liable for errors or omissions. All brand, product, service names and logos are trademarks and/or registered trademarks of their respective owners and are hereby recognized and acknowledged.

Samsung Electronics Co., Ltd.

1, Samsung-ro

Giheung-gu

Yongin-si, Gyeonggi-do, 17113

KOREA

www.samsungled.com

SAMSUNG

Looking for pricing, stock, or lifecycle information?

Click below to explore more details on WIN SOURCE:

- ⊖ [View SCP9TTJ5HEL1TLJF6E on WIN SOURCE](#)
- ⊖ [Samsung Information](#)

Optimize Your Supply Chain with WIN SOURCE Solutions

- ✓ Global Sourcing Solution
- ✓ Obsolete Management
- ✓ Cost Control Management
- ✓ Shortage Management
- ✓ Alternative Solution
- ✓ Excess Inventory Management