



**THE DATASHEET OF
SCP9UTJ5HEL1ULJF6E**



High Power LED Series Chip Scale Package

LH231B



Use of Samsung's Chip Scale Package technology
provide high performance and energy conserving



Features & Benefits

- Utilizes Samsung TF chip technology
- Suitable for use in indoor and outdoor lighting
- Operates at a maximum current of up to 2.0 A
- Compact footprint (2.80 x 2.80 mm)

Applications

- Indoor Lighting: Spotlight, Downlight, MR, PAR
- Outdoor Lighting: Street Light, Tunnel Light, Security Light, Parking Lot Light
- Industrial Lighting: High Bay Light, Low Bay Light
- Consumer Lighting: Torch Light

Table of Contents

1.	Characteristics	-----	3
2.	Product Code Information	-----	6
3.	Typical Characteristics Graphs	-----	12
4.	Outline Drawing & Dimension	-----	14
5.	Reliability Test Items & Conditions	-----	15
6.	Soldering Conditions	-----	16
7.	Tape & Reel	-----	17
8.	Label Structure	-----	19
9.	Packing Structure	-----	20
10.	Precautions in Handling & Use	-----	23

1. Characteristics

a) Absolute Maximum Rating

Item	Symbol	Rating	Unit	Condition
Ambient / Operating Temperature	T_a	-40 ~ +105	°C	Note 1)
Storage Temperature	T_{stg}	-40 ~ +125	°C	-
LED Junction Temperature	T_j	135	°C	-
Forward Current	I_F	2000	mA	Note 1)
Assembly Process Temperature	-	260 <10	°C s	-
ESD (HBM)	-	±2	kV	-

Note:

- 1) Refer to the derating curve, '3. Typical Characteristics Graph', for proper driving current that maintained below maximum junction temperature.

b) Electro-optical Characteristics

Item	Unit	Nominal CCT (K)	Condition		Value Typ.
			I _F (mA)	T _J (°C)	
Luminous Flux (Φ _v)	lm	5000 (70 CRI)	350	85	176
			700	25	365
			700	85	334
			1050	85	480
			2000	85	828
			Forward Voltage (V _F)	V	
Forward Voltage (V _F)	700	25	2.85		
	700	85	2.77		
	1050	85	2.88		
	2000	85	3.12		
	Thermal Resistance (junction to solder point)	K/W			2
Beam Angle	°			120	

Note:

Samsung maintains measurement tolerance of: luminous flux = ±7%, forward voltage = ±0.1 V

c) Luminous Flux Characteristics (T_s = 85 °C)

Sorting @ 700 mA (lm)			Calculated Minimum Flux ²⁾ (lm)			
Flux Rank	Flux Range ¹⁾	Sub Rank	@ 350 mA	@ 700 mA	@ 1050 mA	@ 2000 mA
FF	150 ~210	FB, GB, HB	79	150	216	372
GF	170 ~ 230	GB, HB, JB	89	170	244	421
HF	190 ~250	HB, JB, KB	100	190	273	471
JF	210 ~ 270	JB, KB, MB	111	210	302	521
KF	230 ~ 290	KB, MB, NB	121	230	331	570
MF	250 ~ 310	MB, NB, PB	132	250	359	620
NF	270 ~ 330	NB, PB, QB	142	270	388	669
PF	290 ~ 350	PB, QB, RB	153	290	417	719
QF	310 ~ 370	QB, RB, SB	163	310	446	769
RF	330 ~ 390	RB, SB, TB	174	330	475	818
SF	350 ~ 410	SB, TB, UB	184	350	503	868
TF	370 ~ 430	TB, UB, VB	195	370	532	917
UF	390 ~ 450	UB, VB, WB	205	390	561	967
VF	410 ~ 470	VB, WB, YB	216	410	590	1016
WF	430 ~ 490	WB, YB, ZB	226	430	618	1066

Notes:

- 1) Samsung maintains measurement tolerance of: luminous flux = $\pm 7\%$, CRI = ± 3
- 2) Calculated minimum flux values are for reference only

2. Product Code Information

<u>1</u>	<u>2</u>	<u>3</u>	<u>4</u>	<u>5</u>	<u>6</u>	<u>7</u>	<u>8</u>	<u>9</u>	<u>10</u>	<u>11</u>	<u>12</u>	<u>13</u>	<u>14</u>	<u>15</u>	<u>16</u>	<u>17</u>	<u>18</u>
S	C	P	7	R	T	J	5	H	E	L	1	R	☆	Q	F	6	E

Digit	PKG Information	Code	Specification	
1 2 3	Samsung Chip Scale Package	SCP		
4	CRI	7 8 9	CRI 70 CRI 80 CRI 90	
5	CCT	W V U T R Q P	2700K 3000K 3500K 4000K 5000K 5700K 6500K	
6	Chip Shape	T	Square type	
7 8 9	Product	J5H	Chip version	
10 11 12	Product Purpose	EL1	FEC for lighting	
13 14	CCT (K)	W☆ V☆ U☆ T☆ R☆ Q☆ P☆	2700 3000 3500 4000 5000 5700 6500	WU, WL VU, VL UU, UL TU, TL RU, RL QU, QL PU, PL
			☆ : "U"(MacAdam 3-step ellipse bin), "L" (MacAdam 5-step ellipse bin)	
15 16	Luminous Flux	FF GF HF JF KF MF NF PF QF	150-210 170-230 190-250 210-270 230-290 250-310 270-330 290-350 310-370	FB 150-170 GB 170-190 HB 190-210 JB 210-230 KB 230-250 MB 250-270 NB 270-290 PB 290-310 QB 310-330 RB 330-350 SB 350-370
			Digit 15: Min. spec Digit 16: The number of higher bin(s) from min. spec. e.g.: KB = 230~250 lm, KF = 230~290 lm	
17 18	Forward Voltage (Vf)	6E	2.7 ~ 3.1 V	Bin Code 6A 2.7~2.9V AE 2.9~3.1V

a) Luminous Flux Bins ($I_F = 700 \text{ mA}$, $T_s = 85 \text{ }^\circ\text{C}$)

CRI/ Nominal CCT (K)	Flux rank												
	FB	GB	HB	JB	KB	MB	NB	PB	QB	RB	SB	TB	
(min. flux)	150	170	190	210	230	250	270	290	310	330	350	370	
70	2700							SCP7WTJ5HEL1W☆MF6E					
	3000								SCP7VTJ5HEL1V☆PF6E				
	3500								SCP7UTJ5HEL1U☆PF6E				
	4000									SCP7TTJ5HEL1T☆QF6E			
	5000									SCP7RTJ5HEL1R☆QF6E			
	5700									SCP7QTJ5HEL1Q☆QF6E			
	6500									SCP7PTJ5HEL1P☆PF6E			
80	2700							SCP8WTJ5HEL1W☆MF6E					
	3000								SCP8VTJ5HEL1V☆NF6E				
	3500								SCP8UTJ5HEL1U☆NF6E				
	4000									SCP8TTJ5HEL1T☆PF6E			
	5000									SCP8RTJ5HEL1R☆PF6E			
	5700									SCP8QTJ5HEL1Q☆PF6E			
	6500									SCP8PTJ5HEL1P☆NF6E			
90	2700			SCP9WTJ5HEL1W☆HF6E									
	3000				SCP9VTJ5HEL1V☆JF6E								
	3500				SCP9UTJ5HEL1U☆JF6E								
	4000				SCP9TTJ5HEL1T☆JF6E								

“☆” can be “L” (MacAdam 5-step ellipse bin), “U” (MacAdam 3-step ellipse bin) of the color binning

b) Color Bins ($I_f = 700 \text{ mA}$, $T_s = 85 \text{ °C}$)

Nominal CCT (K)	CRI (R_a)	Color Rank	Chromaticity Bins
2700, 3000, 3500, 4000, 5000, 5700, 6500	70		
2700, 3000, 3500, 4000, 5000, 5700, 6500	80	U (MacAdam 3-Step) L (MacAdam 5-Step)	☆U, ☆L
2700, 3000, 3500, 4000	90		

Notes:

1) ☆ : Nominal CCT code, W(2700K)/V(3000K)/U(3500K)/T(4000K)/R(5000K)/Q(5700K)/P(6500K)

c) Voltage Bins ($I_F = 700 \text{ mA}$, $T_s = 85 \text{ }^\circ\text{C}$)

CRI (Ra)	Nominal CCT (K)	Product Code	Voltage Rank	Voltage Bin	Voltage Range (V)
			6E	6A	2.7 ~ 2.9
				AE	2.9 ~ 3.1

d) Chromaticity Region & Coordinates ($I_f = 700 \text{ mA}$, $T_s = 85 \text{ }^\circ\text{C}$)

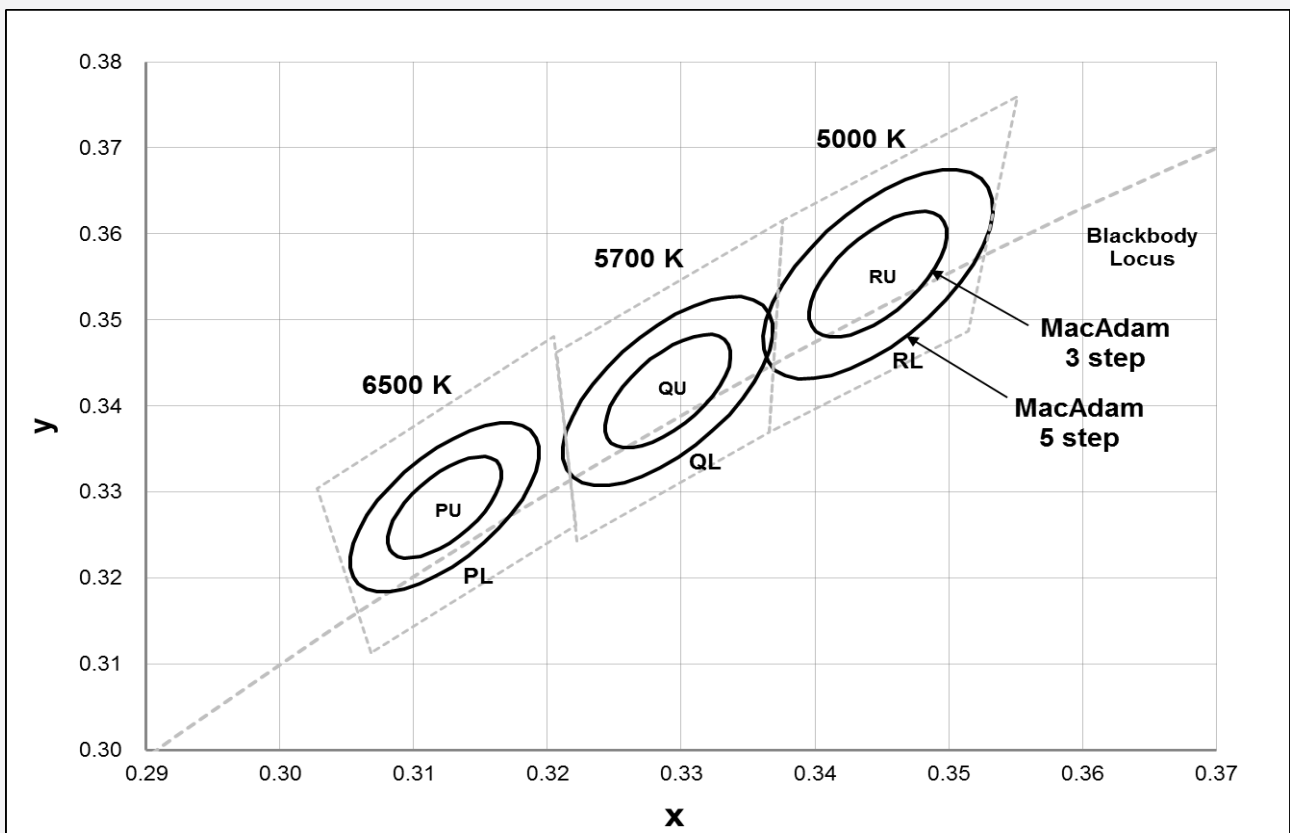

e) Chromaticity Region & Coordinates ($I_F = 700 \text{ mA}$, $T_s = 85 \text{ }^\circ\text{C}$)

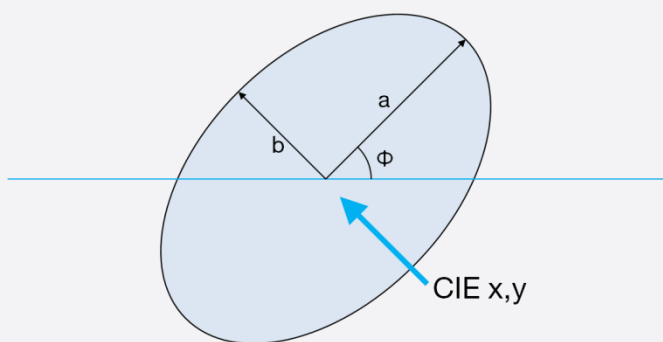

	CCT (K)	Center point		Major-axis	Minor-axis	Rotation
		CIE x	CIE y	a	b	Φ
3 step	2700	0.4578	0.4101	0.0081	0.0042	53.70
	3000	0.4338	0.4030	0.0083	0.0041	53.22
	3500	0.4073	0.3917	0.0093	0.0041	54.00
	4000	0.3818	0.3797	0.0094	0.0040	53.72
	5000	0.3447	0.3553	0.0082	0.0035	59.62
	5700	0.3287	0.3417	0.0075	0.0032	59.10
	6500	0.3123	0.3282	0.0067	0.0029	58.57
5 step	2700	0.4578	0.4101	0.0135	0.0070	53.70
	3000	0.4338	0.4030	0.0138	0.0068	53.22
	3500	0.4073	0.3917	0.0155	0.0068	54.00
	4000	0.3818	0.3797	0.0157	0.0067	53.72
	5000	0.3447	0.3553	0.0137	0.0058	59.62
	5700	0.3287	0.3417	0.0125	0.0053	59.10
	6500	0.3123	0.3282	0.0112	0.0048	58.57

Note:

Samsung maintains measurement tolerance of: $C_x, C_y = \pm 0.005$

3. Typical Characteristics Graphs

a) Spectrum Distribution ($I_F = 700 \text{ mA}$, $T_s = 85 \text{ }^\circ\text{C}$)

3000K/CRI70

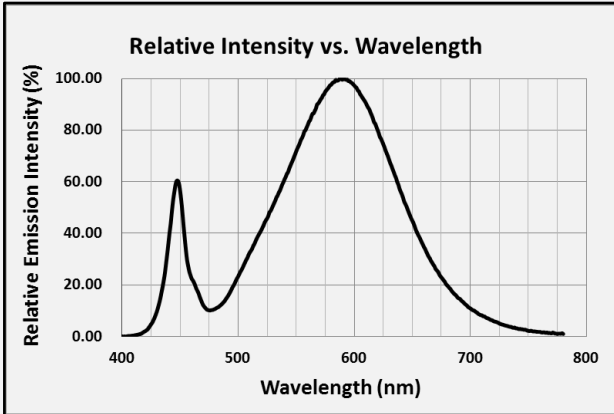

5000K/CRI70

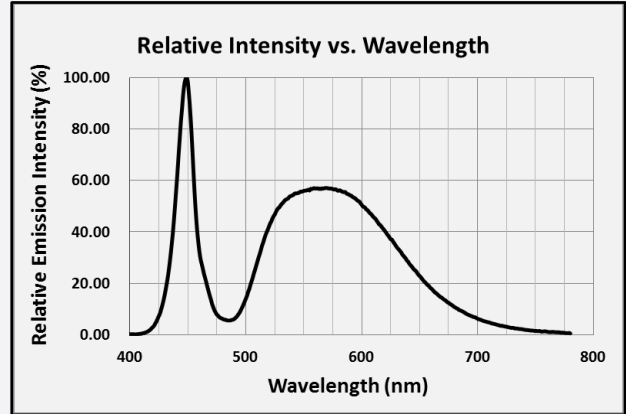

b) Forward Current Characteristics ($T_s = 85 \text{ }^\circ\text{C}$)

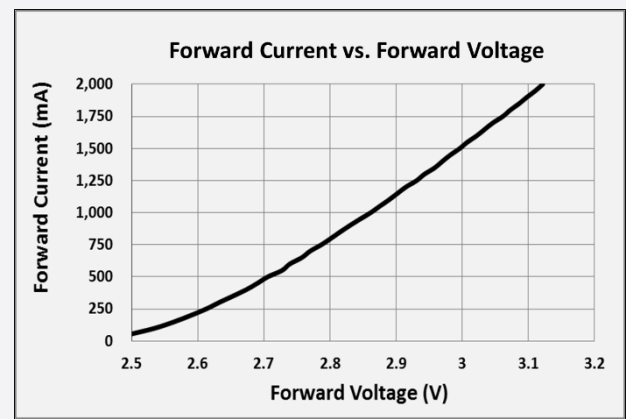

c) Temperature Characteristics ($I_F = 700 \text{ mA}$)

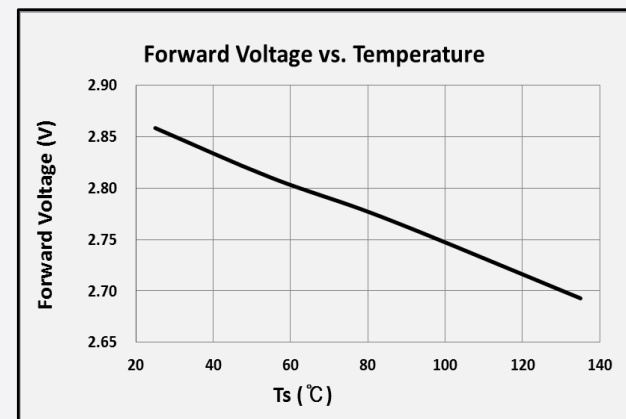

d) Color Shift Characteristics ($I_F = 700 \text{ mA}$, $T_s = 85 \text{ }^\circ\text{C}$)

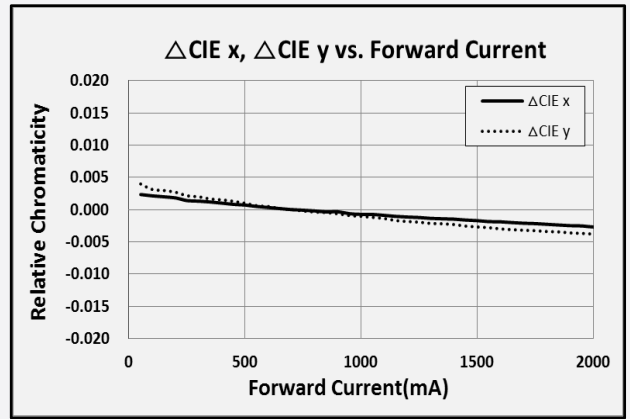

e) Derating Curve and Beam Angle Characteristics ($I_F = 700 \text{ mA}$, $T_s = 25 \text{ }^\circ\text{C}$)

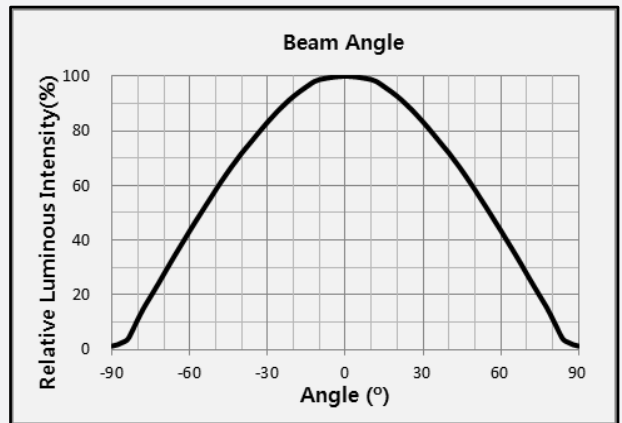

4. Outline Drawing & Dimension



- Measurement unit: mm
- Tolerance: ± 0.13 mm

Precautions:

- 1) Pressure on the LEDs will influence to the reliability of the LEDs. Precautions should be taken to avoid strong pressure on the LEDs. Do not put stress on the LEDs during heating.
- 2) Re-soldering should not be done after the LEDs have been soldered. If re-soldering is unavoidable, LED's characteristics should be carefully checked before and after such repair.
- 3) Do not stack assembled PCBs together. Since materials of LEDs is soft, abrasion between two PCB assembled with LED might cause catastrophic failure of the LEDs.

5. Reliability Test Items & Conditions

a) Test Items

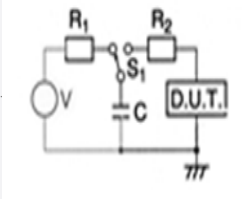
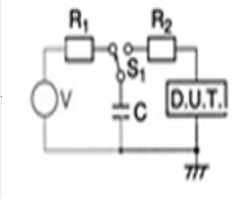
Test Item	Test Condition	Test Hour / Cycle
High Temperature Life Test	85 °C, Derating maximum current	1000 h
High Temperature Humidity Life Test	85 °C, 85% RH, Derating maximum current	1000 h
Temperature Humidity Cycle Test	-10°C ↔ 25°C/Dry, 25°C ↔ 65°C 95% R.H. Derating maximum current	10 cycles
Thermal Shock	-45 °C / 15 min ↔ 125 °C / 15 min temperature change within 5 min	700 cycles
High Temperature Storage	125 °C	1000 h
Low Temperature Storage	-40 °C	1000 h
ESD (HBM)	 <p> R_1: 10 MΩ R_2: 1.5 kΩ C: 100 pF V: ± 2 kV </p>	5 times
ESD (MM)	 <p> R_1: 10 MΩ R_2: 0 C: 200 pF V: ± 0.2 kV </p>	5 times
Vibration Test	20~2000~20 Hz, 200 m/s ² , sweep 4 min X, Y, Z 3 direction, each 1 cycle	4 cycles
Mechanical Shock Test	1500 g, 0.5 ms 3 shocks each X-Y-Z axis	5 cycles

b) Criteria for Judging the Damage

Item	Symbol	Test Condition ($T_s = 25$ °C)	Limit	
			Min.	Max.
Forward Voltage	V_F	$I_F = 700$ mA	Init. Value * 0.9	Init. Value * 1.1
Luminous Flux	Φ_v	$I_F = 700$ mA	Init. Value * 0.7	Init. Value * 1.1

6. Soldering Conditions

a) Reflow Conditions (Pb free)

Reflow frequency: 2 times max.

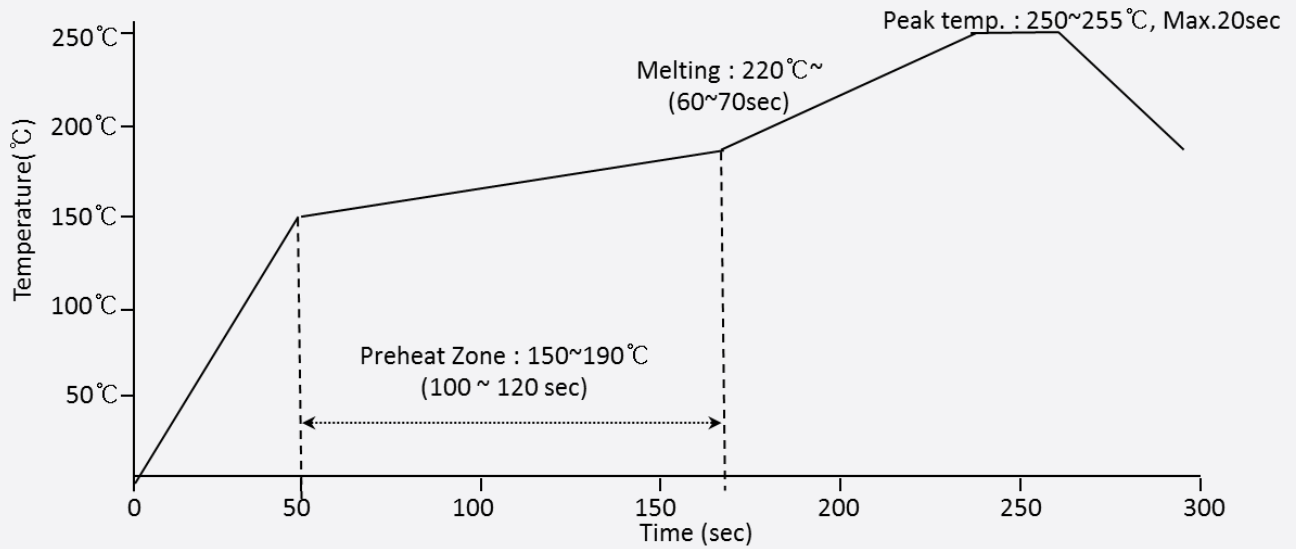

b) Manual Soldering Conditions

No more than 5 seconds @ max. 300 °C, under soldering iron.

7. Tape & Reel

a) Taping Dimension

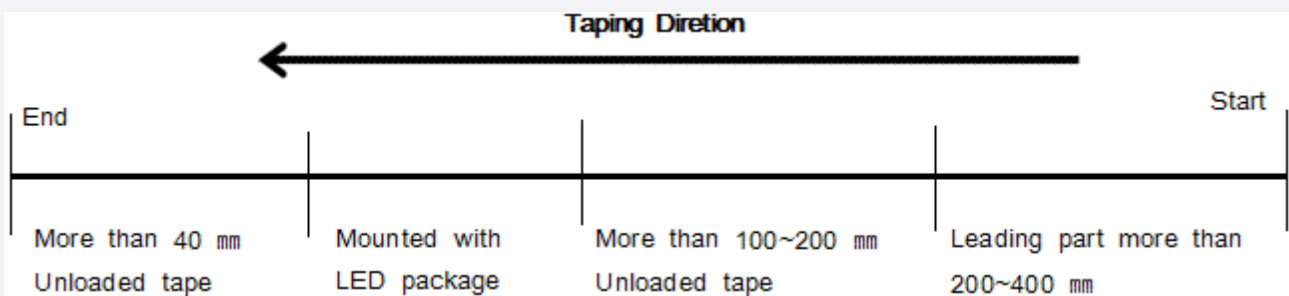
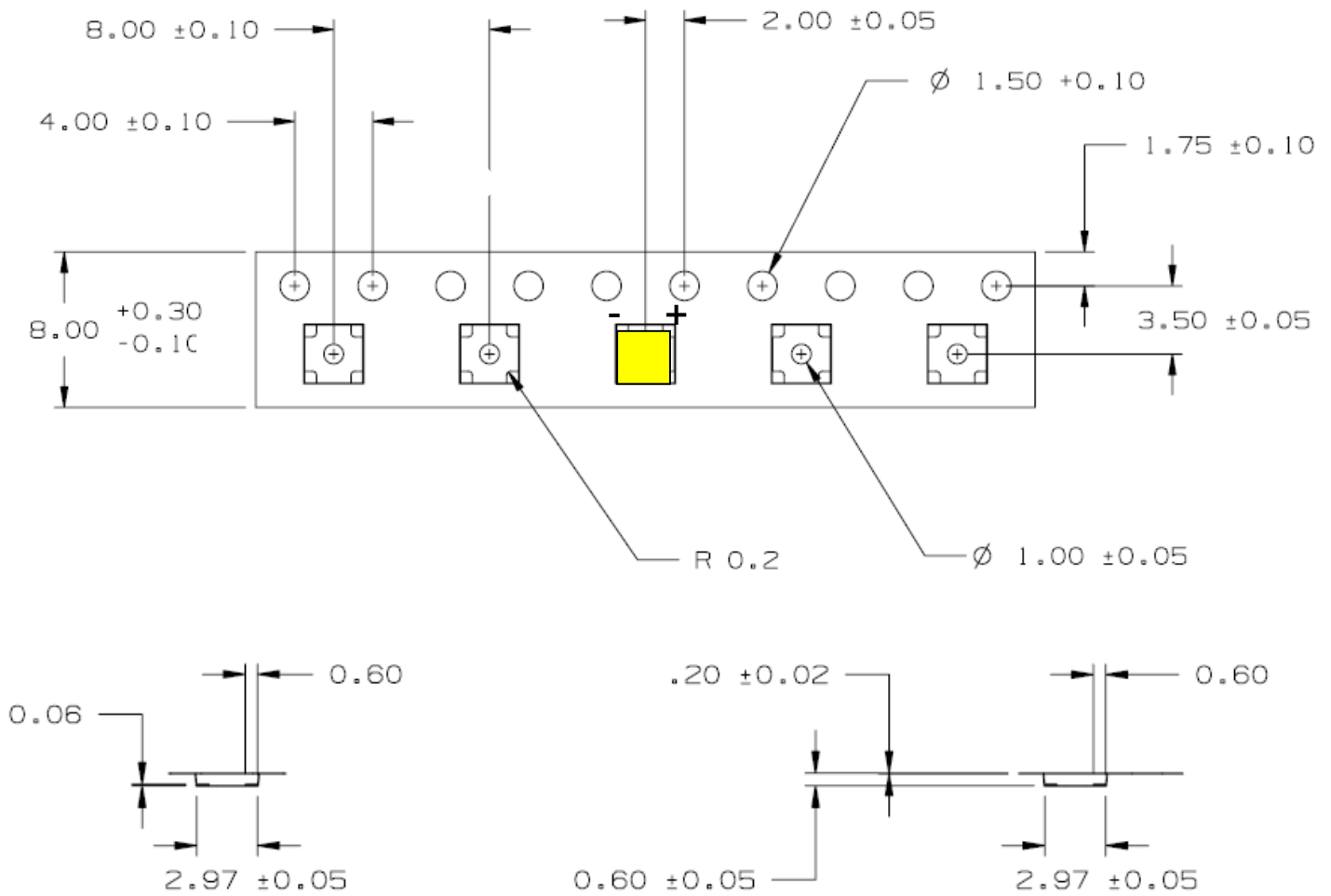

b) Reel Dimension

(unit: mm)

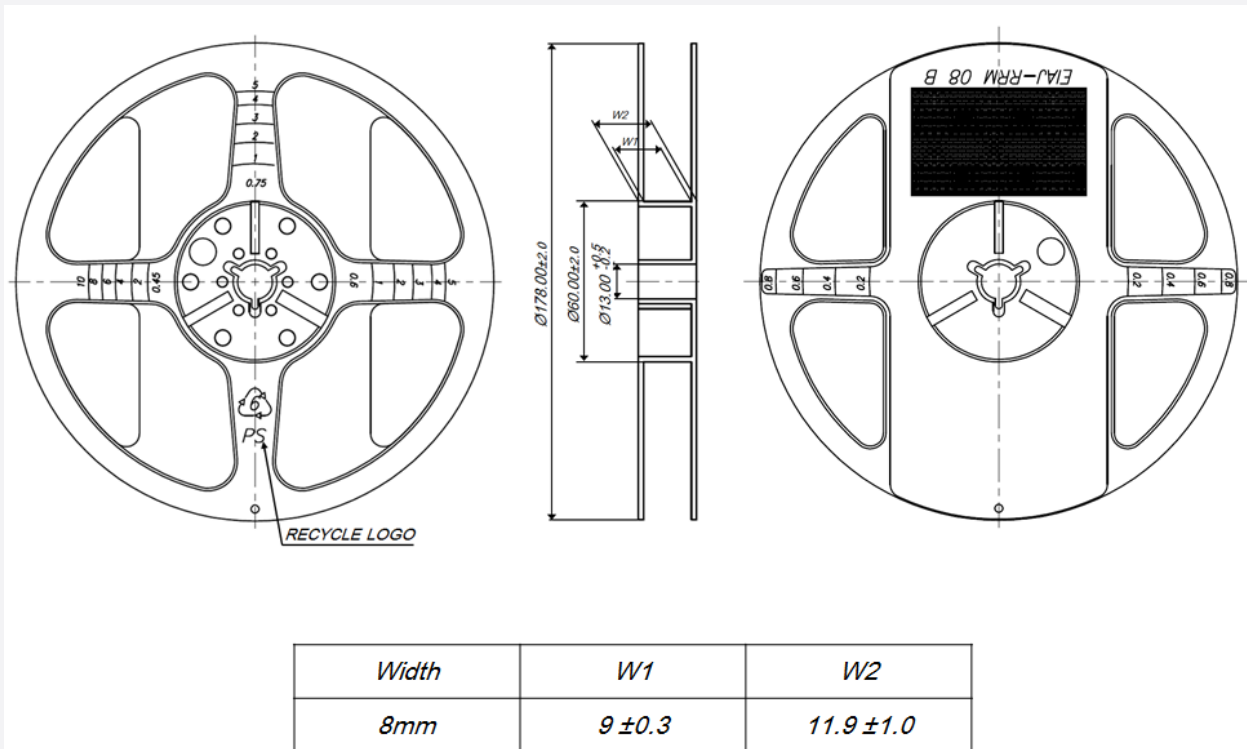
**Notes:**

- 1) Quantity: The quantity/reel is 2,000 pcs
- 2) Cumulative tolerance: Cumulative tolerance / 10 pitches is ± 0.2 mm
- 3) Adhesion strength of cover tape: Adhesion strength is 0.1-0.7 N when the cover tape is turned off from the carrier tape at 10° angle to the carrier tape
- 4) Packaging: P/N, Manufacturing data code no. and quantity are indicated on the aluminum packing bag

8. Label Structure

a) Label Structure



Note: Denoted Bin ID and product code above is only an example

Rank Code:

- ⒶⒷ: Chromaticity bin (refer to page 6)
- ⒸⒹ: Luminous Flux bin (refer to page 6,7)
- ⒺⒻ: Voltage bin (refer to page 6,9)

b) Lot Number

The lot number is composed of the following characters:



- ① : T (T: Taping ID)
- ② : 1 (1: LED Manufacture Line)
- ③ : Year (G:2016, H: 2017, ...)
- ④ : Month (1, 2, ..., 7: July, ..., A: Oct., B: Nov., C: Dec.)
- ⑤ : Day (1~9, A: 10, ..., K: 20, ..., U: 30, V:31)
- ⑥⑦⑧⑨ : Product serial number (0001 ~ 9999)

9. Packing Structure

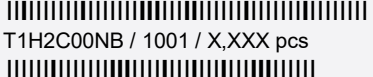

a) Packing Process

Reel

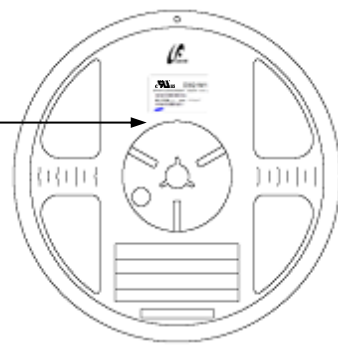

LH231B [CRI] [CCT]
RLQB6A
 SCP7RTJ5HEL1RLQF6E RLQB6A
 T1H2C00NB / 1001 / X,XXX pcs

SAMSUNG



Aluminum Vinyl Packing Bag



LH231B [CRI] [CCT]
RLQB6A
 SCP7RTJ5HEL1RLQF6E RLQB6A
 T1H2C00NB / 1001 / X,XXX pcs

SAMSUNG



Outer Box

Material: Paper SW(B)

Type	Size (mm)			Note
	(a)	(b)	(c)	
7 inch	245 ± 5	220 ± 5	182 ± 5	Up to 7 reels

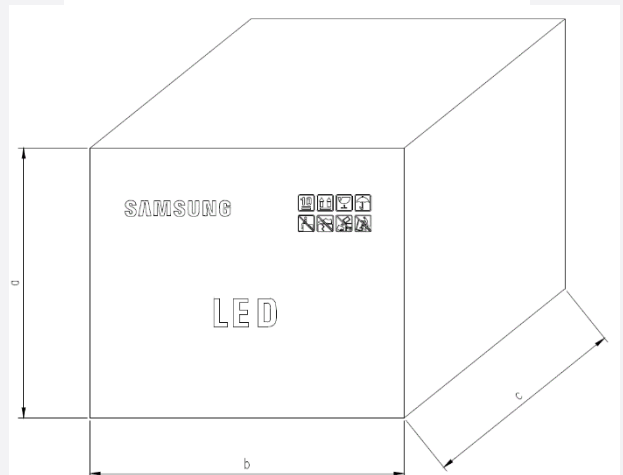

LH231B [CRI] [CCT]
RLQB6A
 SCP7RTJ5HEL1RLQF6E RLQB6A
 T1H2C00NB / 1001 / X,XXX pcs

SAMSUNG



b) Aluminum Vinyl Packing Bag



CAUTION
 This bag contains
MOISTURE SENSITIVE DEVICES

LEVEL
2a

1. Shelf life in sealed bag: 12 months at <math>< 40^{\circ}\text{C}</math> and <math>< 90\%</math> relative humidity (RH)
2. Peak package body temperature: 240 °C
3. After this bag is opened, devices that will be subjected to reflow solder or other high temperature processes must be:
 - a. Mounted within 672 hours at factory conditions of equal to or less than 30°C /60% RH, or
 - b. Stored at <math>< 10\%</math> RH
4. Devices require bake, before mounting, if:
 - a. Humidity Indicator Card is > 65% when read at 23±5°C, or
 - b. 2a is not met.
5. If baking is required, devices must be baked for 1 hours at 60±5°C

Note: If device containers cannot be subjected to high temperature or shorter bake times are desired, reference IPC/JEDEC J-STD-033 for bake procedure.

Bag seal due date: _____
 (if blank, see code label)

Note: Level and body temperature by IPC/JEDEC J-STD-020



LH231B [CRI] [CCT]
RLQB6A

SCP7RTJ5HEL1RLQF6E RLQB6A

T1H2C00NB / 1001 / X,XXX pcs

SAMSUNG



LEAD-FREE





ATTENTION
OBSERVE PRECAUTIONS
FOR HANDLING
ELECTROSTATIC
SENSITIVE
DEVICES



OTHER

주의 사항

이 알루미늄 지퍼 팩은 습기 및 정전기로부터 제품을 보호하기 위하여 제작되었습니다. 개봉 후에는 즉시 솔더 작업을 실시하는 것을 권장합니다.

습기 및 정전기로부터 제품을 보호 하기 위해서 개봉 후 사용하지 않는 자재는 본 팩에 넣어 보관 하시기 바랍니다. 사용하지 않는 자재를 본 팩에 넣을 때는 반드시 동봉된 드라이 팩과 함께 넣고 지퍼부분을 완전하게 밀봉하여 주시기 바랍니다.

Important

This Al Zipper bag is designed to protect the enclosed products from moisture and ESD. Once opened, the products should be soldered onto the printed circuit board immediately. When not in use, please do not leave the products unprotected by the Al Zipper Bag. To repack unused products., please ensure the zip-lock is completely sealed with the dry pack left inside.

c) Silica Gel & Humidity Indicator Card inside Aluminum Vinyl Bag



DESICCANT
SILICA
DO NOT
GEL
SIL

HUMISAFE™ HUMIDITY INDICATOR
COBALT-FREE

10%
20%
30%
40%
50%
60%



Warning if Green Change Desiccant

READ AT TOP OF GREEN COLOR
 CHANGE BETWEEN YELLOW AND GREEN

GP&E Co., Ltd.
6CF-60NS

10. Precautions in Handling & Use

- 1) For over-current protection, users are recommended to apply resistors connected in series with the LEDs to mitigate sudden change of the forward current caused by shift of forward voltage.
- 2) This device should not be used in any type of fluid such as water, oil, organic solvent, etc. When cleaning is required, IPA is recommended as the cleaning agent. Some solvent-based cleaning agent may damage the silicone resins used in the device.
- 3) When the device is in operation, the forward current should be carefully determined considering the maximum ambient temperature and corresponding junction temperature.
- 4) LEDs must be stored in a clean environment.
- 5) After storage bag is opened, device subjected to soldering, solder reflow, or other high temperature processes must be:
 - a. Mounted within 672 hours (28 days) at an assembly line with a condition of no more than 30 °C / 60 % RH, or
 - b. Stored at <10 % RH
- 6) Repack unused devices with anti-moisture packing, fold to close any opening and then store in a dry place.
- 7) Devices require baking before mounting, if humidity card reading is >60 % at 23 ± 5 °C.
- 8) Devices must be baked for 1 hour at 60 ± 5 °C, if baking is required.
- 9) The LEDs are sensitive to the static electricity and surge current. It is recommended to use a wrist band or anti-electrostatic glove when handling the LEDs. If voltage exceeding the absolute maximum rating is applied to LEDs, it may cause damage or even destruction to LED devices. Damaged LEDs may show some unusual characteristics such as increase in leakage current, lowered turn-on voltage, or abnormal lighting of LEDs at low current.
- 10) VOCs (Volatile Organic Compounds) can be generated from adhesives, flux, hardener or organic additives used in luminaires (fixtures). Transparent LED silicone encapsulant is permeable to those chemicals and they may lead to a discoloration of encapsulant when they exposed to heat or light. This phenomenon can cause a significant loss of light emitted (output) from the luminaires. In order to prevent these problems, we recommend users to know the physical properties of materials used in luminaires and they must be carefully selected.
- 11) Risk of sulfurization (or tarnishing)

The LED from Samsung does not use a silver-plated lead frame but if the LED is attached in silver-plated substrate, the surface color of substrate may change to black (or dark colored) when it is exposed to sulfur (S), chlorine (Cl) or other halogen compound. Sulfurization of substrate may cause intensity degradation, change of chromaticity coordinates and, in extreme cases, open circuit, It requires caution. Due to possible sulfurization of substrate, LED should not be used and stored together with oxidizing substances made of materials such as rubber, plain paper, lead solder cream, etc.

Legal and additional information.

[About Samsung Electronics Co., Ltd.](#)

Samsung inspires the world and shapes the future with transformative ideas and technologies.

The company is redefining the worlds of TVs, smartphones, wearable devices, tablets, digital appliances, network systems, and memory, system LSI, foundry and LED solutions. For the latest news, please visit the Samsung Newsroom at news.samsung.com.

Copyright © 2020 Samsung Electronics Co., Ltd. All rights reserved.

Samsung is a registered trademark of Samsung Electronics Co., Ltd.

Specifications and designs are subject to change without notice. Non-metric weights and measurements are approximate. All data were deemed correct at time of creation. Samsung is not liable for errors or omissions. All brand, product, service names and logos are trademarks and/or registered trademarks of their respective owners and are hereby recognized and acknowledged.

Samsung Electronics Co., Ltd.

1, Samsung-ro

Giheung-gu

Yongin-si, Gyeonggi-do, 17113

KOREA

www.samsungled.com

SAMSUNG

Looking for pricing, stock, or lifecycle information?

Click below to explore more details on WIN SOURCE:

- ⊖ [View SCP9UTJ5HEL1ULJF6E on WIN SOURCE](#)
- ⊖ [Samsung Information](#)

Optimize Your Supply Chain with WIN SOURCE Solutions

- ✓ Global Sourcing Solution
- ✓ Obsolete Management
- ✓ Cost Control Management
- ✓ Shortage Management
- ✓ Alternative Solution
- ✓ Excess Inventory Management