

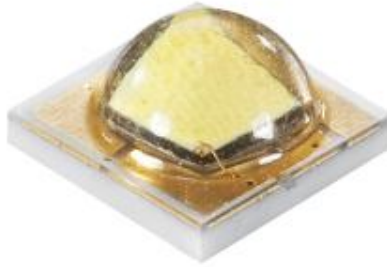

**THE DATASHEET OF
SPHWHTL3D305E6TPJ2**



LH351A – 3535 Ceramic LED @25°C



Introduction

Features

- Package : Ceramic Substrate LED Package
- View Angle: 125 °
- Precondition : JEDEC Level 2a
- Dimension : 3.5 x 3.5 x 1.89 mm
- ESD withstand Voltage : up to ±5KV [HBM]
- Reliability Test : IES-LM-80-08 qualified

Applications

- INDOOR LIGHTING : Spot light, Down light
- OUTDOOR LIGHTING : Street light, Security light, Tunnel light, Parking lots light
- INDUSTRIAL LIGHTING : High-bay light, Low-bay light
- CONSUMER LIGHTING : Torch light

SAMSUNG ELECTRONICS

95, Samsung2-Ro, Giheung-Gu,
Yongin-City, Gyeonggi-Do 446-711, KOREA

Copyright © 2009-2011 SAMSUNG ELECTRONICS Co.,Ltd. All rights reserved. The information in this document is subject to change without notice. SAMSUNG,  SAMSUNG is a registered trademark of SAMSUNG ELECTRONICS.

Contents

1. Luminous Flux Characteristics	-----	3
2. Characteristics	-----	6
3. Typical Characteristics Graph	-----	7
4. Outline Drawing & Dimension	-----	13
5. Reliability Test Items and Conditions	-----	14
6. Solder Conditions	-----	15
7. Tape & Reel	-----	16
8. Label Structure	-----	17
9. Packing Structure	-----	18
10. Precaution For Use	-----	20
11. Hazard Substance Analysis	-----	22
12. Revision History	-----	27

1. Luminous Flux Characteristics (T_j= 25°C)

Nominal CCT	Minimum CRI ¹⁾	Sorting condition Flux ²⁾ @350mA		Calculated Minimum Flux ³⁾			Product Code	BIN Structure
		Rank	Min Flux ²⁾	@700mA	@1000mA	@1500mA		
2700K	80	G4	100	182	244	334	SPHWHTL3D305E6W0G4	Whole
							SPHWHTL3D305E6WUG4	Half
							SPHWHTL3D305E6WPG4	Quater
							SPHWHTL3D305E6WMG4	M3
		H3	110	200	268	368	SPHWHTL3D305E6W0H3	Whole
							SPHWHTL3D305E6WUH3	Half
							SPHWHTL3D305E6WPH3	Quater
							SPHWHTL3D305E6WMH3	M3
	90	E6	80	146	195	267	SPHWHTL3D307E6W0E6	Whole
							SPHWHTL3D307E6WUE6	Half
							SPHWHTL3D307E6WPE6	Quater
							SPHWHTL3D307E6WME6	M3
		F5	90	164	219	301	SPHWHTL3D307E6W0F5	Whole
							SPHWHTL3D307E6WUF5	Half
							SPHWHTL3D307E6WPF5	Quater
							SPHWHTL3D307E6WMF5	M3
G4	100	182	244	334	SPHWHTL3D307E6W0G4	Whole		
					SPHWHTL3D307E6WUG4	Half		
					SPHWHTL3D307E6WPG4	Quater		
					SPHWHTL3D307E6WMG4	M3		
3000K	70	H5	110	200	268	368	SPHWHTL3D303E6V0H5	Whole
							SPHWHTL3D303E6VPH5	Quater
		J4	120	218	293	401	SPHWHTL3D303E6V0J4	Whole
							SPHWHTL3D303E6VPJ4	Quater
		K3	130	237	317	434	SPHWHTL3D303E6V0K3	Whole
							SPHWHTL3D303E6VPK3	Quater

1. Luminous Flux Characteristics (T_j= 25°C) (Continued)

Nominal CCT	Minimum CRI ¹⁾	Sorting condition Flux ²⁾ @350mA		Calculated Minimum Flux ³⁾			Product Code	BIN Structure
		Rank	Min Flux ²⁾	@700mA	@1000mA	@1500mA		
3000K	80	G4	100	182	244	334	SPHWHTL3D305E6V0G4	Whole
							SPHWHTL3D305E6VUG4	Half
							SPHWHTL3D305E6VPG4	Quater
							SPHWHTL3D305E6VMG4	M3
	H3	110	200	268	368	SPHWHTL3D305E6V0H3	Whole	
						SPHWHTL3D305E6VUH3	Half	
						SPHWHTL3D305E6VPH3	Quater	
						SPHWHTL3D305E6VMH3	M3	
3500K	80	G4	100	182	244	334	SPHWHTL3D305E6U0G4	Whole
							SPHWHTL3D305E6UUG4	Half
							SPHWHTL3D305E6UPG4	Quater
							SPHWHTL3D305E6UMG4	M3
	H3	110	200	268	368	SPHWHTL3D305E6U0H3	Whole	
						SPHWHTL3D305E6UUH3	Half	
						SPHWHTL3D305E6UPH3	Quater	
						SPHWHTL3D305E6UMH3	M3	
4000K	70	K3	130	237	317	434	SPHWHTL3D303E6T0K3	Whole
		M2	140	254	341	468	SPHWHTL3D303E6T0M2	Whole
	80	G4	100	182	244	334	SPHWHTL3D305E6T0G4	Whole
							SPHWHTL3D305E6TUG4	Half
							SPHWHTL3D305E6TPG4	Quater
							SPHWHTL3D305E6TMG4	M3
	H3	110	200	268	368	SPHWHTL3D305E6T0H3	Whole	
						SPHWHTL3D305E6TUH3	Half	
						SPHWHTL3D305E6TPH3	Quater	
						SPHWHTL3D305E6TMH3	M3	
	J2	120	218	293	401	SPHWHTL3D305E6T0J2	Whole	
						SPHWHTL3D305E6TUJ2	Half	
SPHWHTL3D305E6TPJ2						Quater		
SPHWHTL3D305E6TMJ2						M3		



1. Luminous Flux Characteristics (T_j= 25°C) (Continued)

Nominal CCT	Minimum CRI ¹⁾	Sorting condition Flux ²⁾ @350mA		Calculated Minimum Flux ³⁾			Product Code	BIN Structure
		Rank	Min Flux ²⁾	@700mA	@1000mA	@1500mA		
5000K	70	J4	120	218	293	401	SPHWHTL3D303E6RTJ4	half
		K3	130	237	317	434	SPHWHTL3D303E6RTK3	half
		M2	140	254	341	468	SPHWHTL3D303E6RTM2	half
	75	J4	120	218	293	401	SPHWHTL3D304E6RTJ4	half
		K3	130	237	317	434	SPHWHTL3D304E6RTK3	half
5700K	70	J4	120	218	293	401	SPHWHTL3D303E6QTJ4	half
		K3	130	237	317	434	SPHWHTL3D303E6QTK3	half
		M2	140	254	341	468	SPHWHTL3D303E6QTM2	half
	75	J4	120	218	293	401	SPHWHTL3D304E6QTJ4	half
		K3	130	237	317	434	SPHWHTL3D304E6QTK3	half
6500K	70	J4	120	218	293	401	SPHWHTL3D303E6PTJ4	half
		K3	130	237	317	434	SPHWHTL3D303E6PTK3	half
		M2	140	254	341	468	SPHWHTL3D303E6PTM2	half
7600K	68	J4	120	218	293	401	SPHWHTL3D303E6N0J4	Whole
		K3	130	237	317	434	SPHWHTL3D303E6N0K3	Whole

Notes:

- 1) SAMSUNG ELECTRONICS maintains a tolerance of ±3.0 on CRI measurements.
- 2) SAMSUNG ELECTRONICS maintains a tolerance of ±7% on flux measurements.
- 3) Calculated flux values are for reference only.

2. Characteristics

1) Electro-optical Characteristics

Item	Unit	Min	Typ	Max
Forward voltage ¹⁾ (@350 mA, T _j = 25°C)	V	2.70	2.95	3.30
Forward voltage ¹⁾ (@700 mA, T _j = 25°C)	V		3.09	
Forward voltage ¹⁾ (@1000 mA, T _j = 25°C)	V		3.19	
Forward voltage ¹⁾ (@1500 mA, T _j = 25°C)	V		3.34	
Operation forward current (T _j = 25°C)	mA	–	–	1500
Thermal resistance R _{th,j-c}	°C/W	–	4	6
LED junction temperature T _j	°C	–	–	150
Operating temperature range T _{opr}	°C	–40	–	85
Storage temperature range T _{stg}	°C	–40	–	100
Viewing Angle	°	–	125	–

Item	Unit	3000K	5000K
Forward voltage ¹⁾ (@350 mA, T _j = 25°C)	V	2.95	
Forward voltage ¹⁾ (@350 mA, T _j = 85°C)	V	2.86	
Luminous flux (@350 mA, T _j = 25°C)	lm	110	136
Luminous flux ²⁾ (@350 mA, T _j = 85°C)	lm	101	125
Luminous flux ²⁾ (@700 mA, T _j = 85°C)	lm	184	227
Luminous flux ²⁾ (@1000 mA, T _j = 85°C)	lm	246	305
Luminous flux ²⁾ (@1500 mA, T _j = 85°C)	lm	337	417

Notes:

- 1) SAMSUNG ELECTRONICS maintains a tolerance of ±0.1V on forward voltage measurements.
- 2) Characteristics @ 85°C are for reference only.

2) Vf Rank

Parameter	Symbol	Condition	Rank	Rank	Min.	Typ.	Max.
Forward Voltage	V _F	I _F = 350mA	E6	E3	2.7	–	3.0
				H3	3.0	–	3.3

3. Typical Characteristics Graph

1) Spectrum Distribution

($T_j = 25^\circ\text{C}$)

2700K(CRI 80) & 3000K(CRI 80)

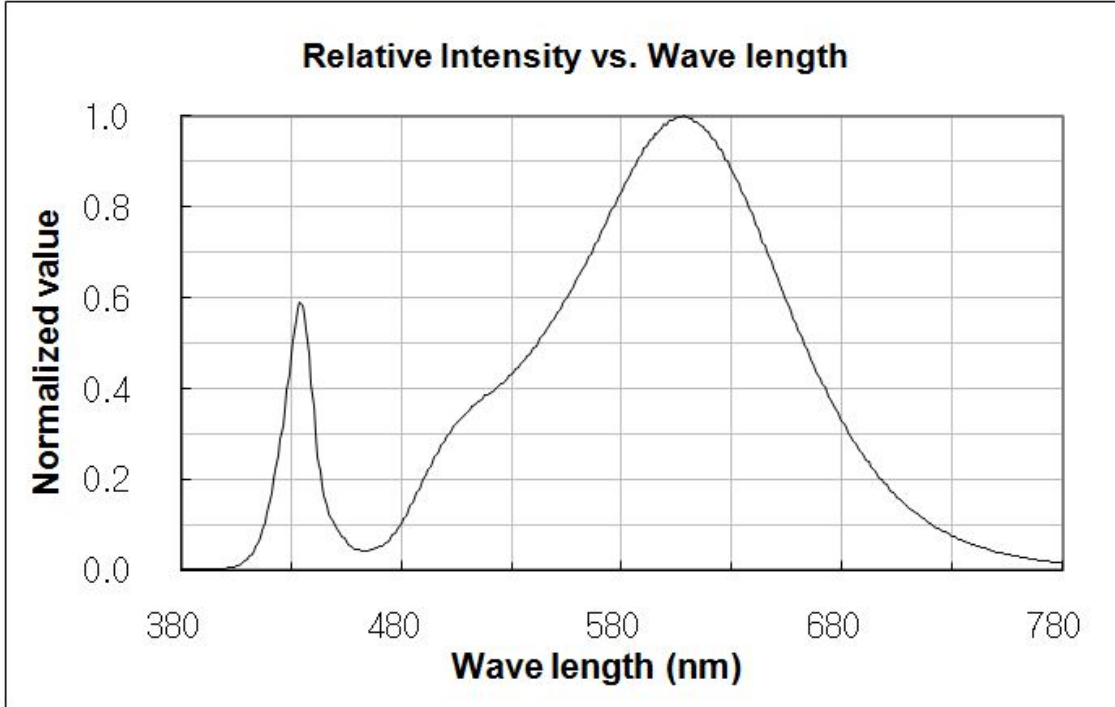

3500K(CRI 80) & 4000K(CRI 80)

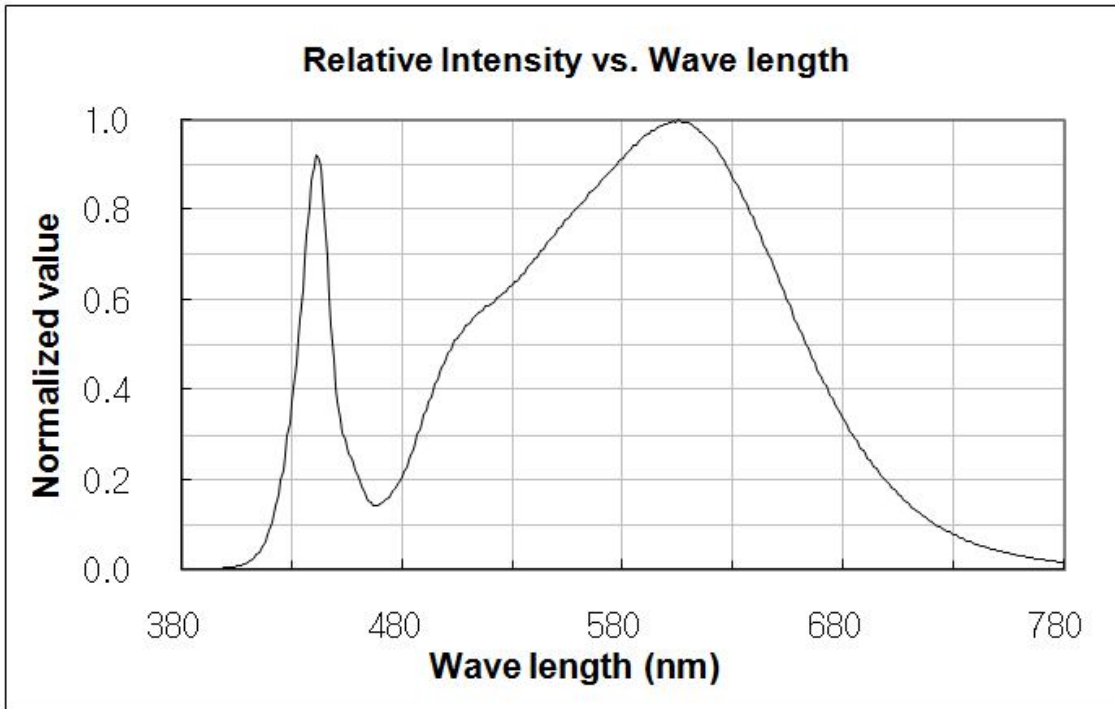

5000K(CRI 70) & 5700K(CRI 70)

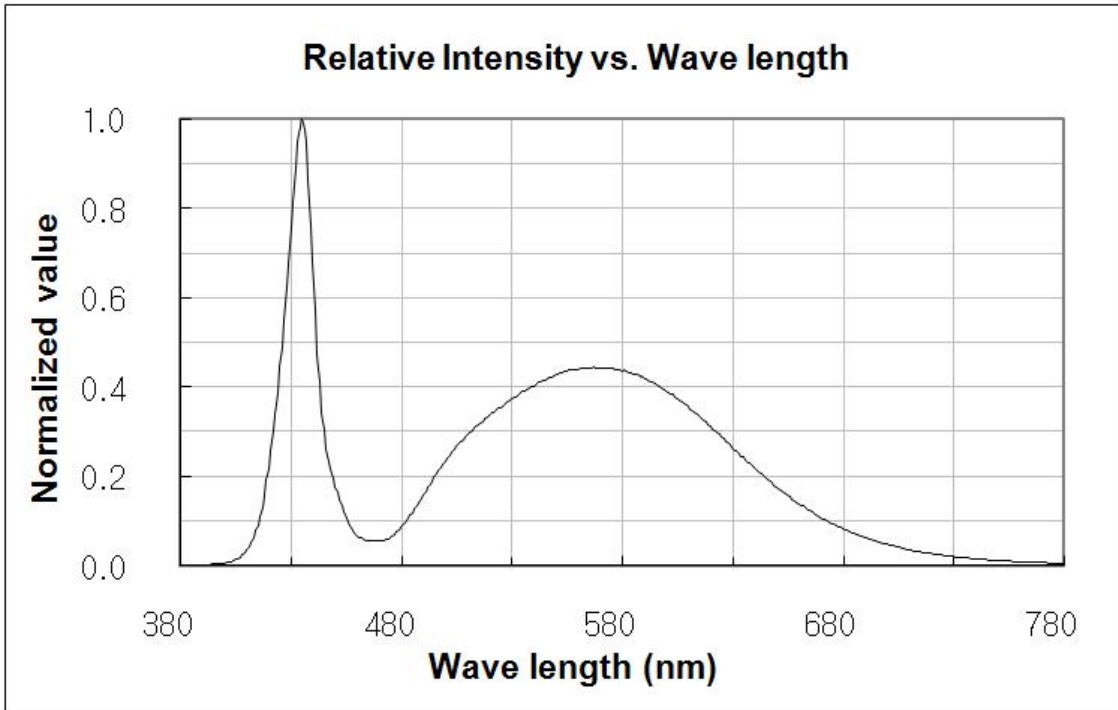

6500K(CRI 70) & 7600K(CRI 68)

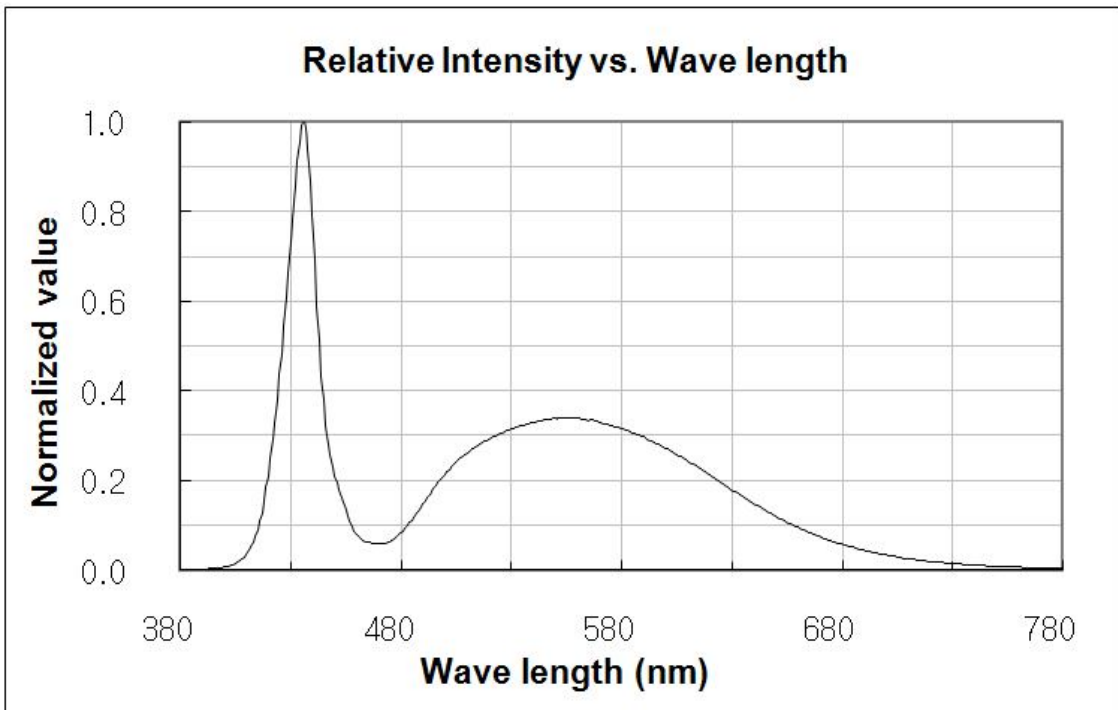

2) Forward Current Characteristics

($T_j = 25^\circ\text{C}$)

Relative Flux vs. Forward Current

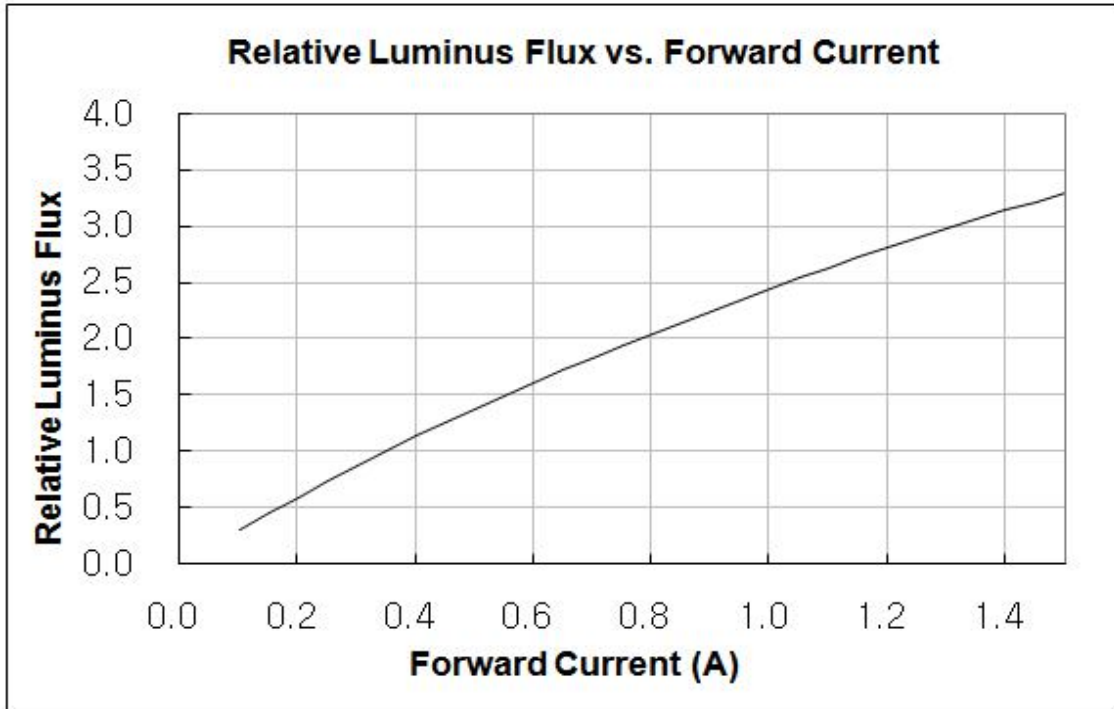

Forward Current vs. Forward Voltage

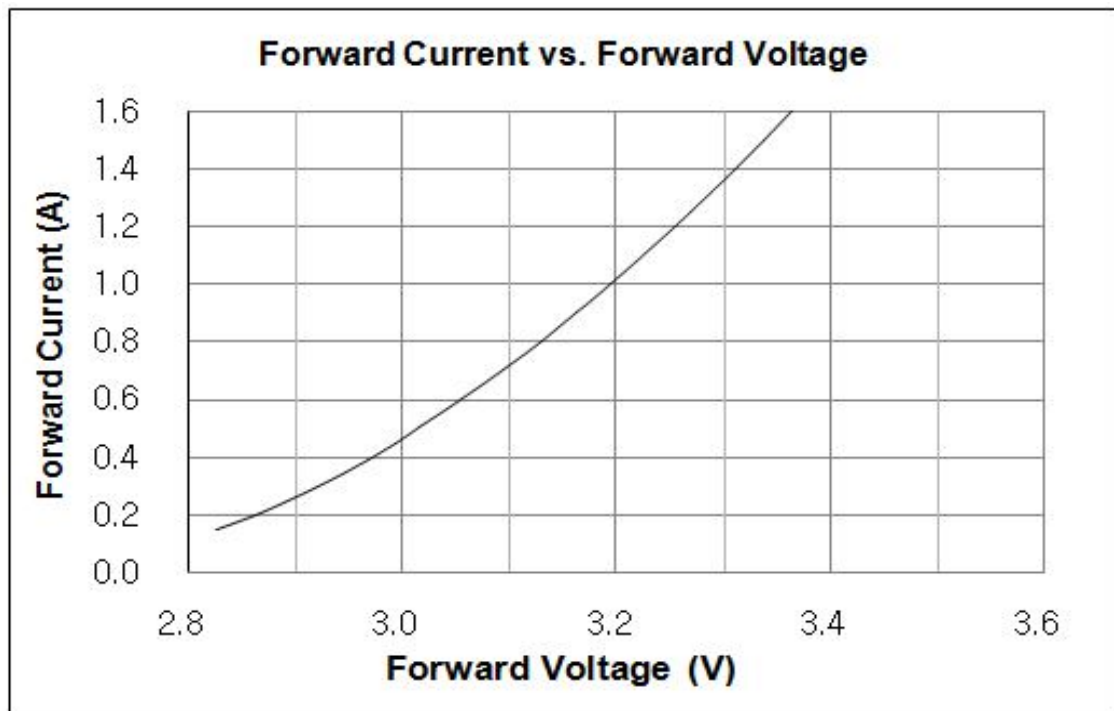

3) Temperature Characteristics

Relative Flux vs. T_s (solder temp.)

($I_F = 350\text{mA}$)

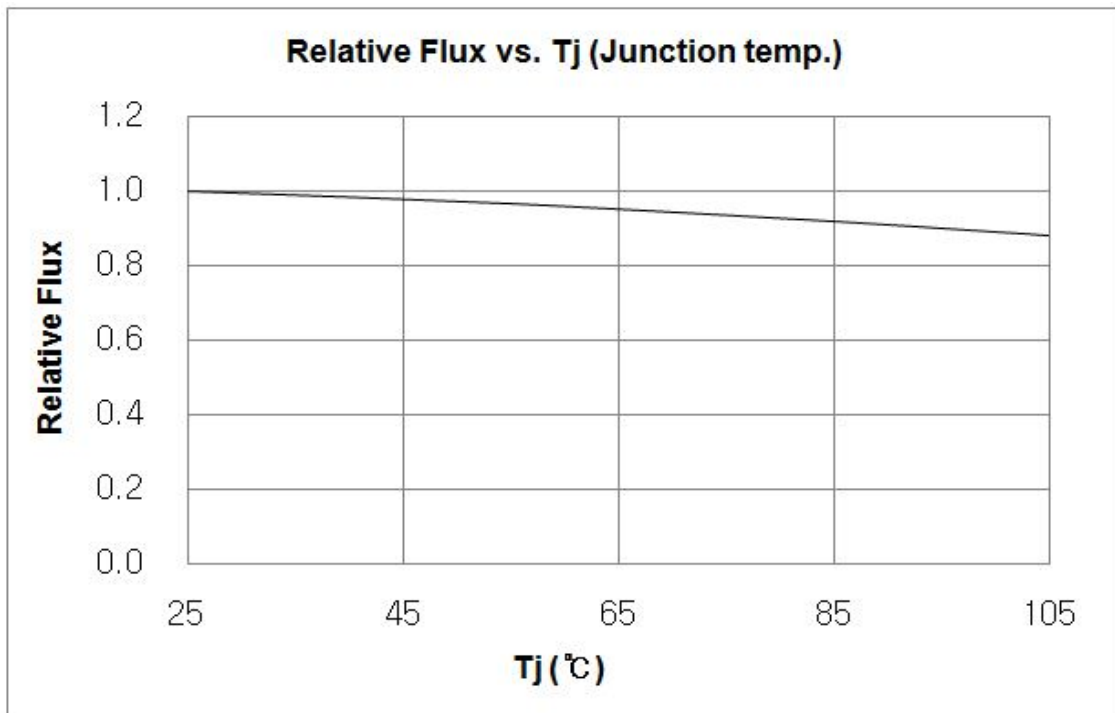

Forward Voltage vs. T_s (solder temp.)

($I_F = 350\text{mA}$)

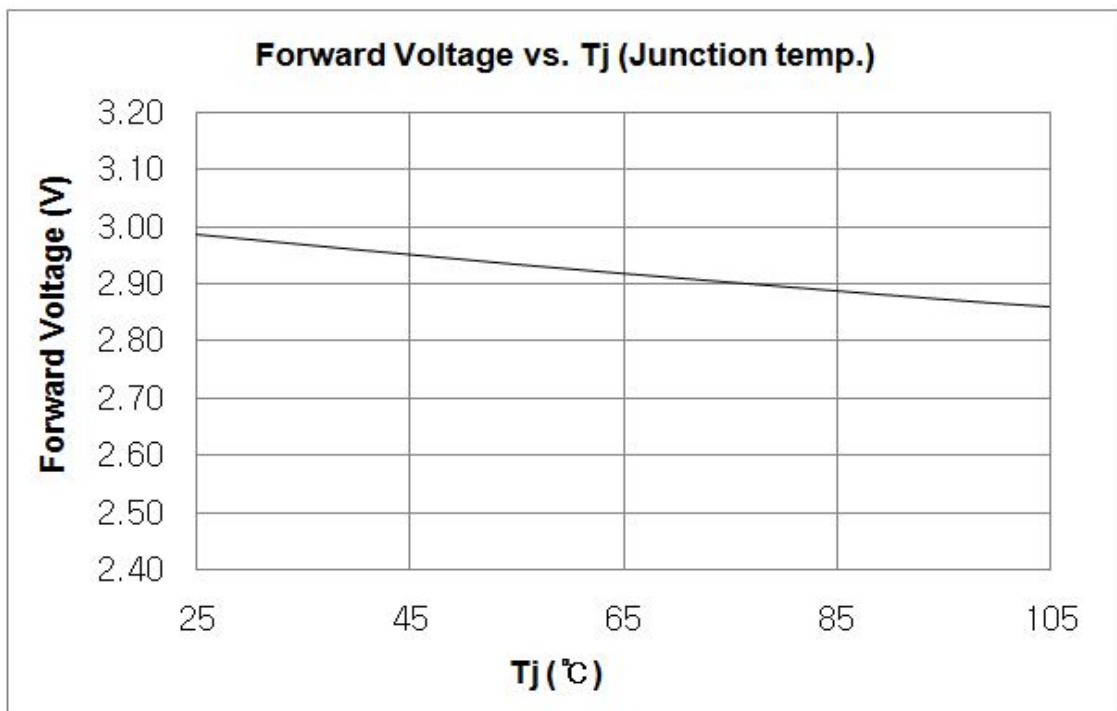

4) Color shift Characteristics

Color x,y vs. Forward Current

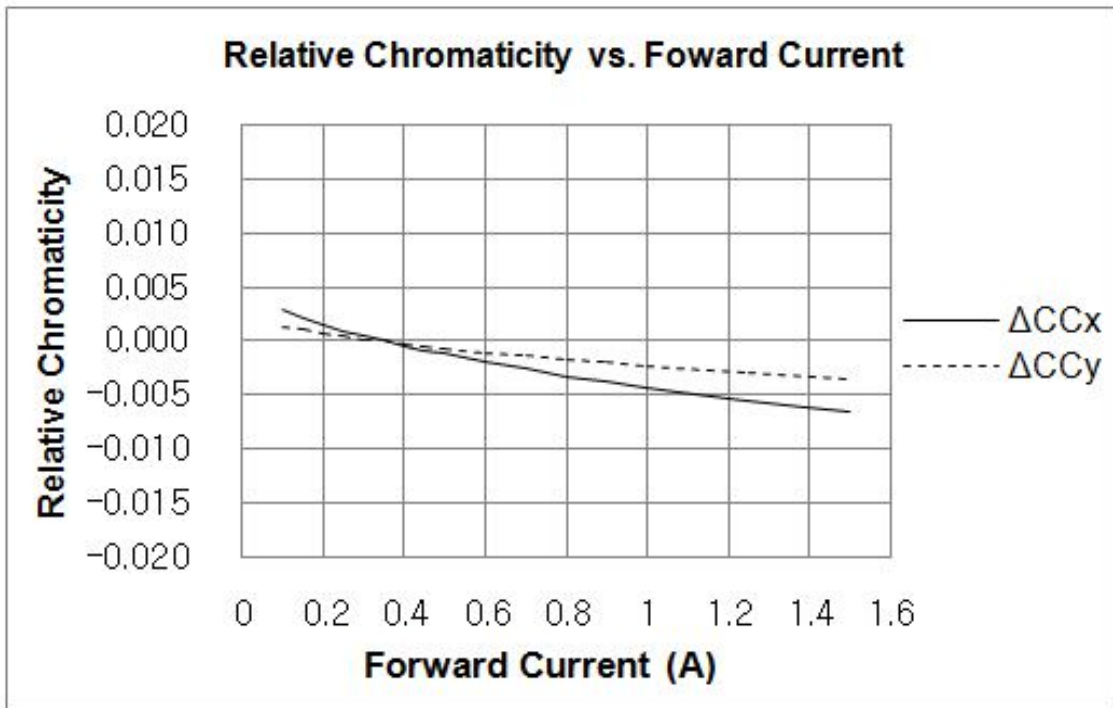

Color x,y vs. Substrate Temp.

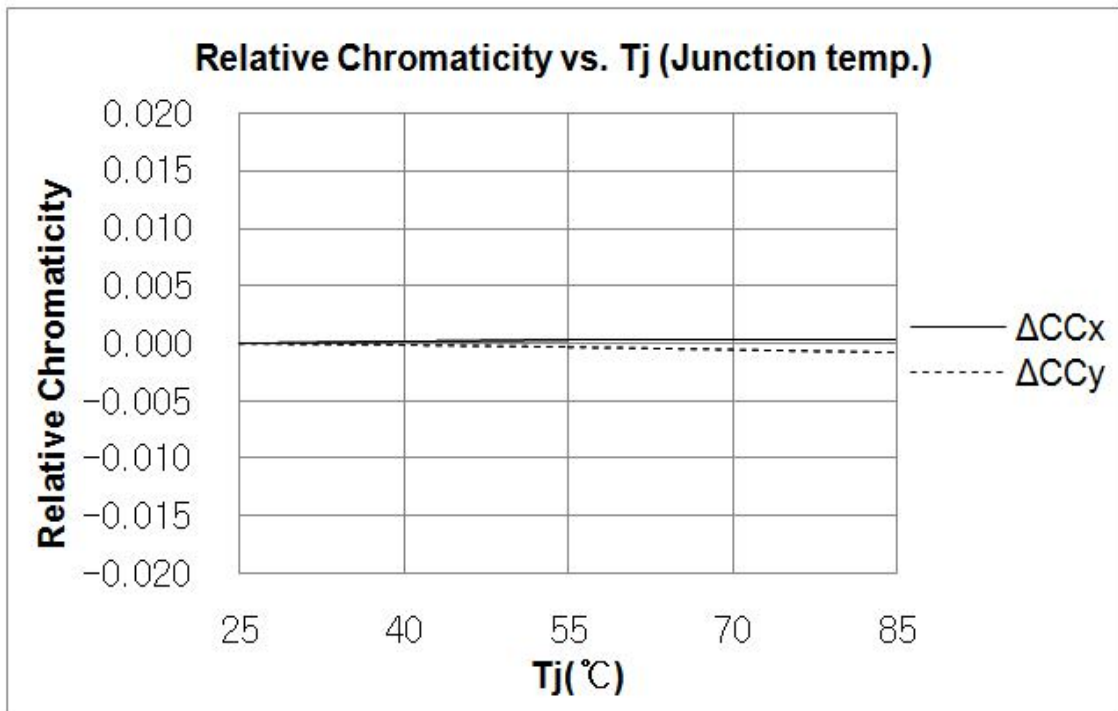

5) Derating Curve

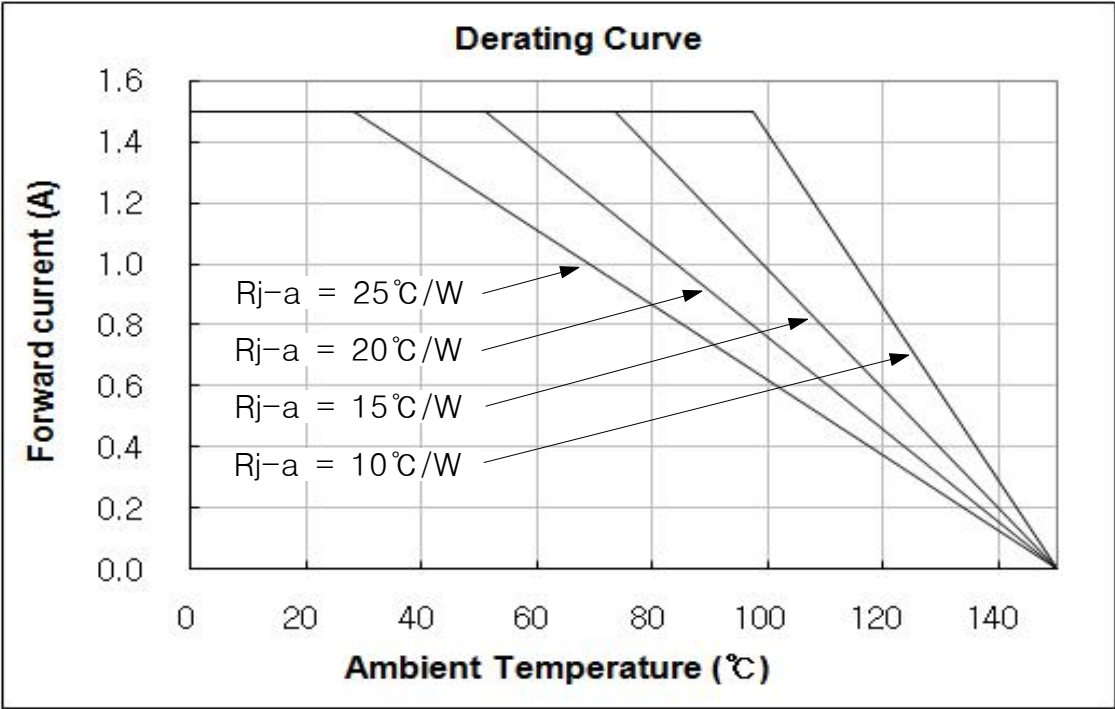

6) Viewing angle Characteristics

Viewing angle

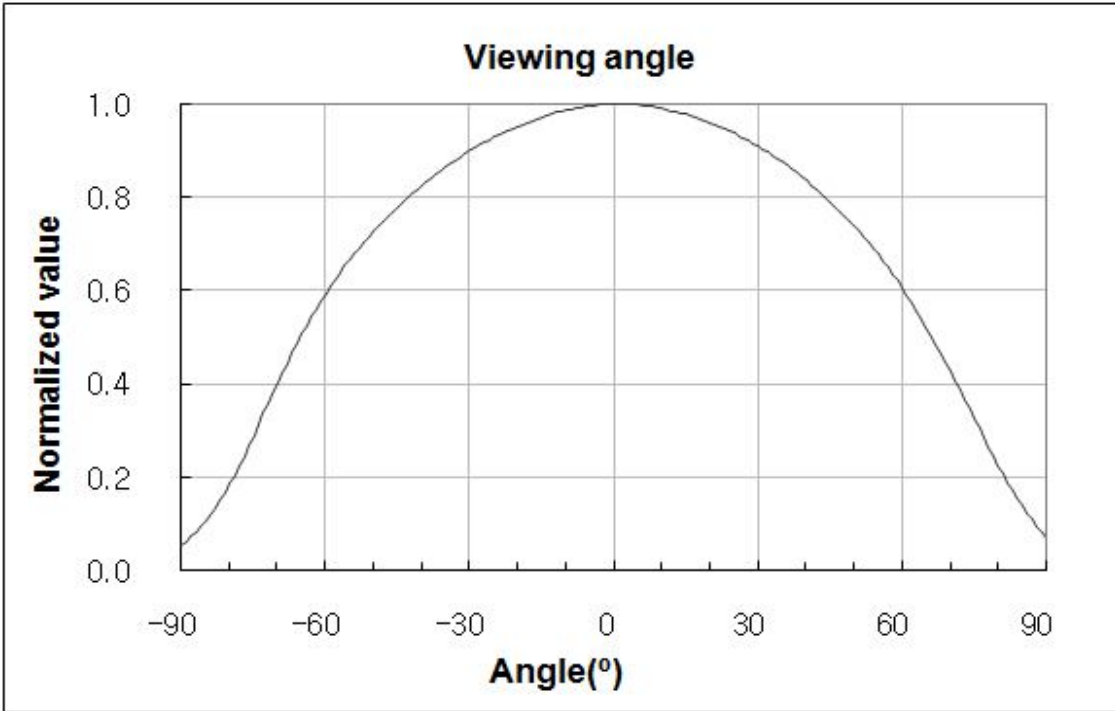

4. Outline Drawing & Dimension

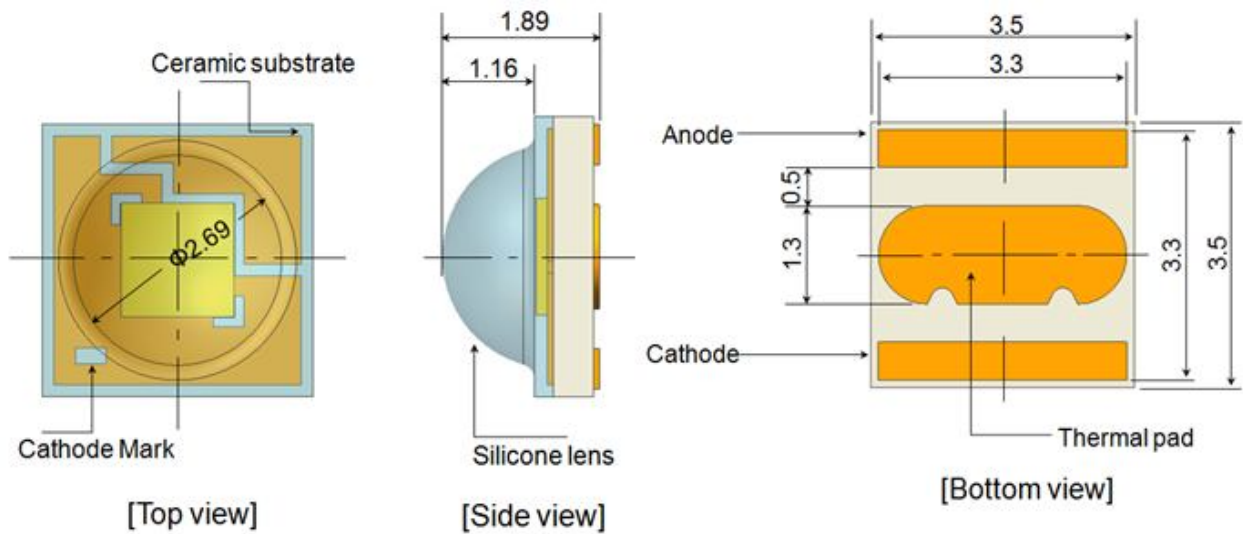

Recommended Land Pattern

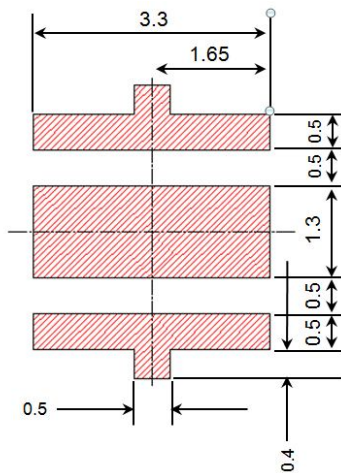

unit : mm
Tolerance : ± 0.13

- * This LED has built-in ESD protection device(s) connected in parallel to LED Chip(s).
- * The thermal pad is electrically isolated from the anode and cathode contact pads.

Ts Point & Measurement Method

- * Measure the nearest point to the thermal pad as shown below. If necessary, remove PSR of PCB to reach Ts point.
- * Thermal pad must be soldered to the PCB to dissipate heat properly. Otherwise, LED can be damaged.

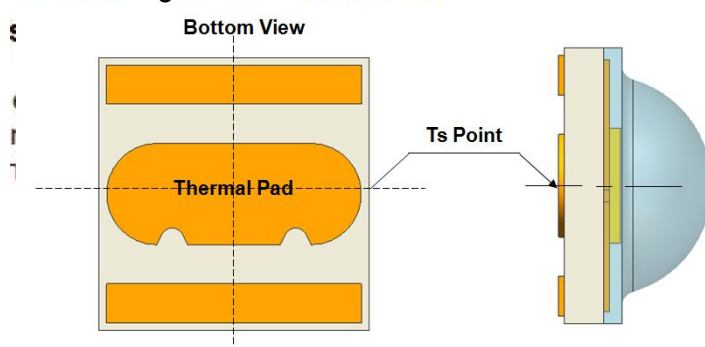

5. Reliability Test Items and Conditions

1) Test Items and Results

Test Items	Test Conditions	Test Hours/Cycles	n
Room Temperature Life Test	25℃, DC 1000 mA	1000 Hr	22
High Temperature humidity Life Test	85℃, 85%, DC 1000 mA	1000 Hr	22
High Temperature Life Test	85℃, DC 1000 mA	1000 Hr	22
Low Temperature Life Test	-40℃, DC 1000 mA	1000 Hr	22
Temperature Humidity Cycle	-10℃ ↔ 25℃ 95%RH ↔ 85℃ 95%RH 1000mA, 95%RH, 24hrs/1cycle	10 Cycles	11
Thermal Shock	-45℃/15 min ↔ 125℃/ 15 min. Temp.change within 5min.	500 Cycles	100
High Temperature Storage	Ta=120℃	1000 Hr	11
Low Temperature Storage	Ta=-40℃	1000 Hr	11
ESD(HBM)	Q1=10MΩ, R2=1.5KΩ, C=100pF, V=±5KV, 5Times	5 Times (±5kV)	5

6. Solder Conditions

1) Reflow Conditions (Pb Free)

Reflow Frequency : 2 times max.

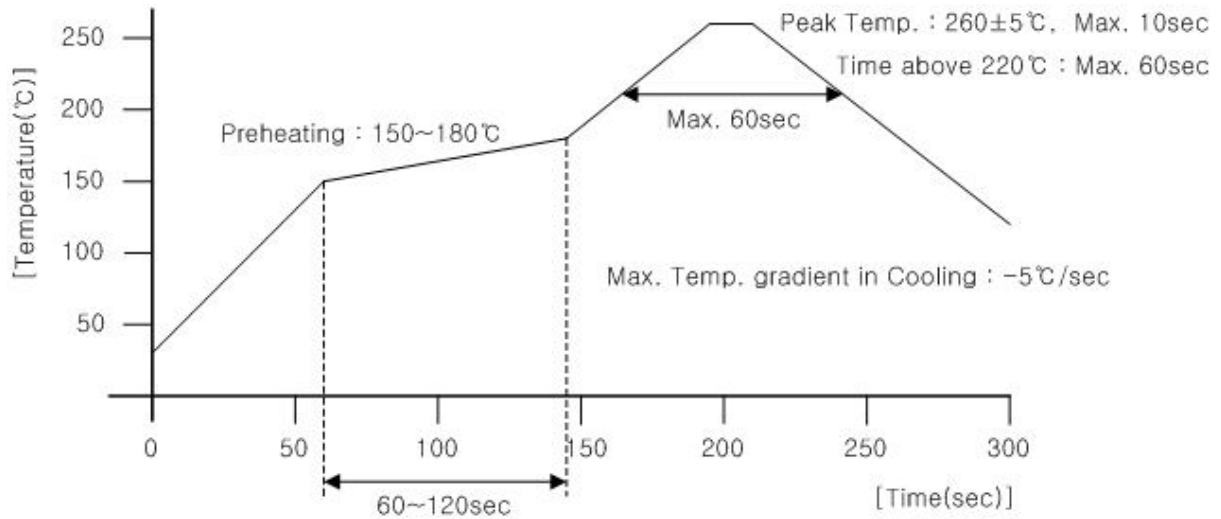

2) For Manual Soldering

Not more than 5 seconds @Max. 300°C, under soldering iron.

7. Tape And Reel

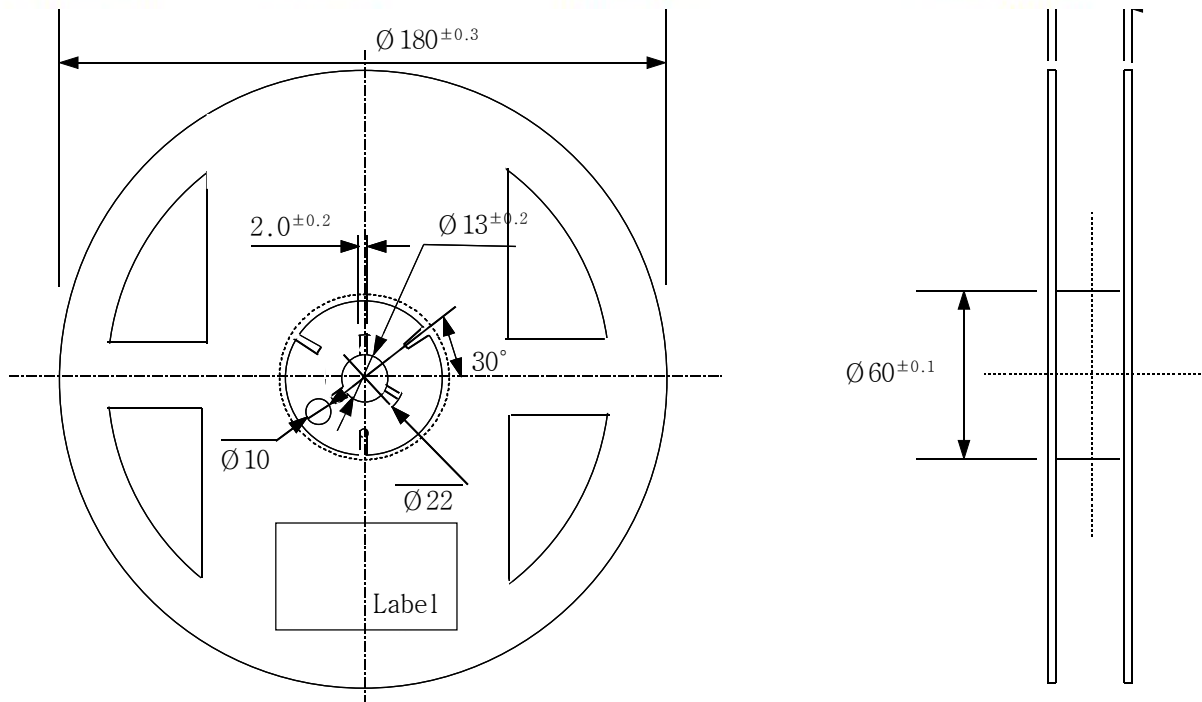
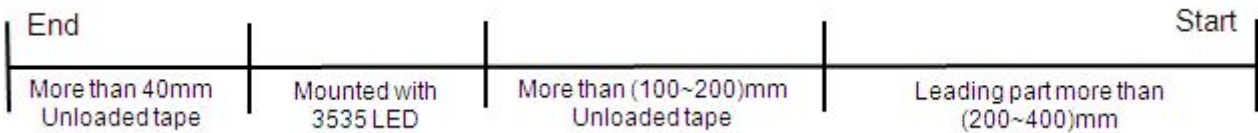
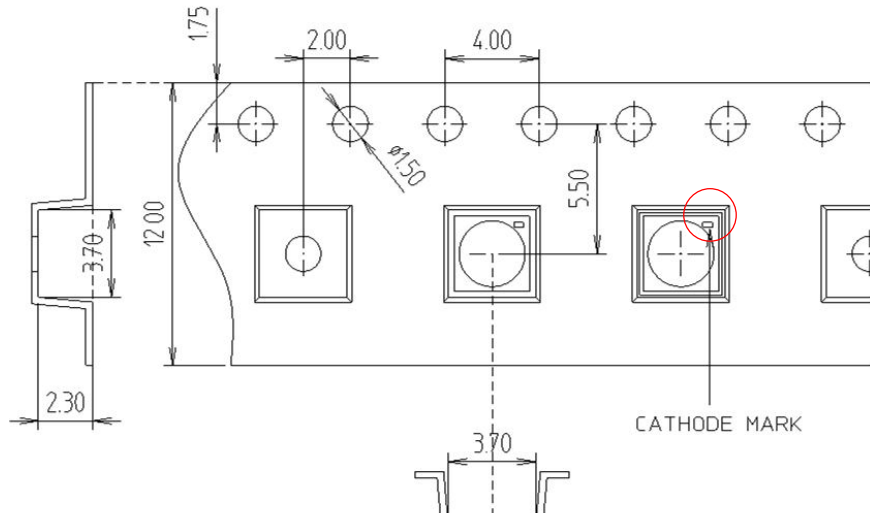

- (1) Quantity : The quantity/reel to be 1,000 pcs.
- (2) Cumulative Tolerance : Cumulative tolerance/10 pitches to be ± 0.2 mm
- (3) Adhesion Strength of Cover Tape : Adhesion strength to be 0.1-0.7N when the cover tape is turned off from the carrier tape at 10° angle to be the carrier tape.
- (4) Packaging : P/N, Manufacturing data code no. and quantity to be indicated on a damp proof package.



8. Label Structure

1) Label Structure



Rank Code

/E1/ : VF Rank

/Q1/ : Color Rank

/J1/ : Flux Bin

2) LOT Number

The Lot number is composed of the following characters

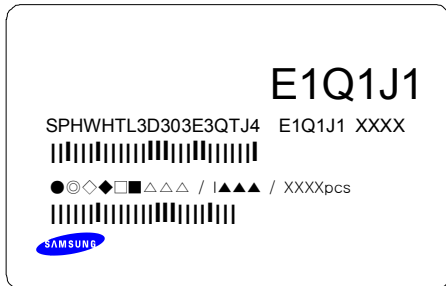

●◎◇◆□■△△△ / |▲▲▲ / 1000PCS

● : Production Site (S:SAMSUNG ELECTRONICS, G:Gosin China)

◎ : L (LED)

◇ : Product State (A:Normality, B:Bulk, C:First Production, R:Reproduction, S:Sample)

◆ : Year (S:2008, T:2009, U:2010...)

□ : Month (1 ~ 9, A, B)

■ : Day (1 ~ 9, A, B ~ V)

△ : SAMSUNG ELECTRONICS Product Number (1 ~ 999)

▲ : Reel Number (1 ~ 999)



9. Packing Structure

1) Packing Process

Reel

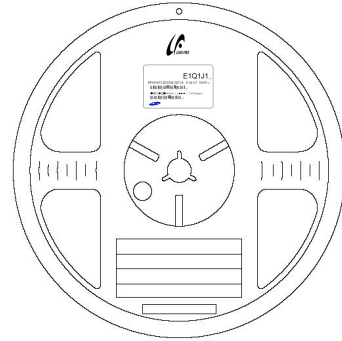

Aluminum Vinyl Bag

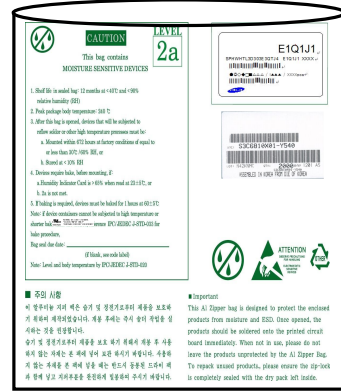
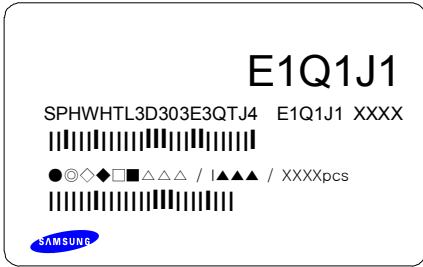

Out Box (Max. 7 Aluminum Vinyl Bag)

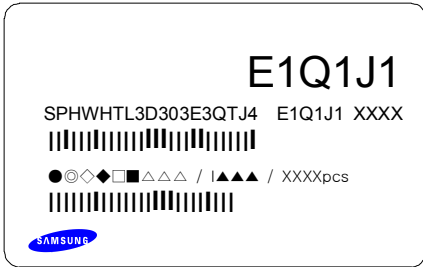

Material :

Paper(DW2A/DW(AB))

TYPE	SIZE(mm)		
	a	b	c
7inch	250	225	190

2) Aluminum Packing Bag



CAUTION

This bag contains
MOISTURE SENSITIVE DEVICES

LEVEL

2a

1. Shelf life in sealed bag: 12 months at 40°C and 90% relative humidity (RH)
2. Peak package body temperature: 240°C
3. After this bag is opened, devices that will be subjected to reflow solder or other high temperature processes must be:
 - a. Mounted within 672 hours at factory conditions of equal to or less than 30°C / 60% RH, or
 - b. Stored at 10% RH
4. Devices require bake, before mounting, if:
 - a. Humidity Indicator Card is > 65% when read at $23 \pm 5^{\circ}\text{C}$, or
 - b. 2a is not met.
5. If baking is required, devices must be baked for 1 hours at $60 \pm 5^{\circ}\text{C}$

Note: if device containers cannot be subjected to high temperature or shorter bake times are desired, reference IPC/JEDEC J-STD-033 for bake procedure,

Bag seal due date: _____
(if blank, see code label)

Note: Level and body temperature by IPC/JEDEC J-STD-020

E1Q1J1

SPHWHTL3D303E3QTJ4 E1Q1J1 XXXX



●◎◇◆□△△△ / ▲▲▲ / XXXXpcs





QTY: S3C6810X01-Y540



LOT: N42KNMC QTY: 2000 U/W: 1201 AS
S3C6810X01-Y540
ASSEMBLED IN KOREA FROM DIE OF KOREA



LEAD-FREE





ATTENTION
OBSERVE PRECAUTIONS
FOR HANDLING
ELECTROSTATIC
SENSITIVE
DEVICES



OTHER

주의 사항

이 알루미늄 지퍼 백은 습기 및 정전기로부터 제품을 보호하기 위하여 제작되었습니다. 개봉 후에는 즉시 솔더 작업을 실시하는 것을 권장합니다.

습기 및 정전기로부터 제품을 보호 하기 위해서 개봉 후 사용하지 않는 자재는 본 팩에 넣어 보관 하시기 바랍니다. 사용하지 않는 자재를 본 팩에 넣을 때는 반드시 동봉된 드라이 팩과 함께 넣고 지퍼부분을 완전하게 밀봉하여 주시기 바랍니다.

Important

This Al Zipper bag is designed to protect the enclosed products from moisture and ESD. Once opened, the products should be soldered onto the printed circuit board immediately. When not in use, please do not leave the products unprotected by the Al Zipper Bag. To repack unused products., please ensure the zip-lock is completely sealed with the dry pack left inside.

There are Silica Gel and Humidity Indicator Card in the Aluminum Bag



10. Precaution for use

- 1) For over current-protection, customers are recommended to apply resistors connected in series with the LEDs to mitigate sudden change of the forward current caused by shift of the forward voltage.
- 2) This device should not be used in any type of fluid such as water, oil, organic solvent, etc. When cleaning is required, IPA is recommended as cleaning agent. Solvent-based cleaning agent such as Zestron^(R) may damage the silicone resins used in the device.
- 3) When the device is in operation, the forward current should be carefully determined considering the maximum ambient temperature and the corresponding junction temperature.
- 4) LEDs must be stored in a clean environment. If the LEDs are to be stored for 3 months or more after being shipped from SAMSUNG ELECTRONICS, they should be packed with a nitrogen-filled container.
(Shelf life of sealed bags: 12 months, temp. 0~40°C, 0~90%RH)
- 5) After storage bag is open, device subject to soldering, solder reflow, or other high temperature processes must be:
 - a. Mounted within 672 hours (28 days) at an assembly line with a condition of no more than 30°C/60%RH.
 - b. Stored at <10% RH.
- 6) Repack unused Products with anti-moisture packing, fold to close any opening and then store in a dry place.
- 7) Devices require baking before mounting, if humidity card reading reaches 60% at 23±5°C.
- 8) Devices must be baked for 1hours at 60±5°C, if baking is required.
- 9) The LEDs are sensitive to the static electricity and surge current. It is recommended to use a wrist band or anti-electrostatic glove when handling the LEDs.
If voltage exceeding the absolute maximum rating is applied to LEDs, it may cause damage or even destruction to LED devices.
Damaged LEDs may show some unusual characteristics such as increase in leakage current, lowered turn-on voltage, or abnormal lighting of LEDs at low current.
- 10) VOCs (volatile organic compounds) can be generated from adhesives, flux, hardener or organic additives used in luminaires (fixtures). Transparent LED silicone encapsulant is permeable to those chemicals and they may lead a discoloration of encapsulant when they expose to heat or light. This phenomenon can cause a significant loss of light emitted(output) from the luminaires(fixture). This phenomenon can give a significant loss of light emitted(output) from the luminaires(fixture). In order to prevent these problems, we recommend you to know the physical properties of materials used in luminaires, They must be selected carefully.

11) Risk of Sulfurization (or Tarnishing)

The LED from Samsung Electronics uses a silver-plated lead frame and its surface color may change to black(or dark colored) when it is exposed to sulfur (S), chlorine (Cl) or other halogen compound. Sulfurization of lead frame may cause intensity degradation, change of chromaticity coordinates and, in extreme cases, open circuit. It requires caution. Due to possible sulfurization of lead frame, LED should not be used and stored together with oxidizing substances made of materials in a following list, : Rubber, plain paper, lead solder cream and so on.

Test Report No. F690101/LF-CTSAYAA13-13769

Issued Date: 2013. 03. 22 Page 2 of 5

Sample No. : AYAA13-13769.001
 Sample Description : SPHWHTL3D
 Item No./Part No. : LH351A
 Materials : Al2O3,Cu,Ni,Pd,Au,Silicone,Phosphor

Heavy Metals

Test Items	Unit	Test Method	MDL	Results
Cadmium (Cd)	mg/kg	With reference to IEC 62321:2008, ICP	0.5	N.D.
Lead (Pb)	mg/kg	With reference to IEC 62321:2008, ICP	5	N.D.
Mercury (Hg)	mg/kg	With reference to IEC 62321:2008, ICP	2	N.D.
Hexavalent Chromium (CrVI)	mg/kg	With reference to IEC 62321:2008, UV-VIS	1	N.D.

Flame Retardants- PBBs/PBDEs

Test Items	Unit	Test Method	MDL	Results
Monobromobiphenyl	mg/kg	With reference to IEC 62321:2008, GC-MS	5	N.D.
Dibromobiphenyl	mg/kg	With reference to IEC 62321:2008, GC-MS	5	N.D.
Tribromobiphenyl	mg/kg	With reference to IEC 62321:2008, GC-MS	5	N.D.
Tetrabromobiphenyl	mg/kg	With reference to IEC 62321:2008, GC-MS	5	N.D.
Pentabromobiphenyl	mg/kg	With reference to IEC 62321:2008, GC-MS	5	N.D.
Hexabromobiphenyl	mg/kg	With reference to IEC 62321:2008, GC-MS	5	N.D.
Heptabromobiphenyl	mg/kg	With reference to IEC 62321:2008, GC-MS	5	N.D.
Octabromobiphenyl	mg/kg	With reference to IEC 62321:2008, GC-MS	5	N.D.
Nonabromobiphenyl	mg/kg	With reference to IEC 62321:2008, GC-MS	5	N.D.
Decabromobiphenyl	mg/kg	With reference to IEC 62321:2008, GC-MS	5	N.D.
Monobromodiphenyl ether	mg/kg	With reference to IEC 62321:2008, GC-MS	5	N.D.
Dibromodiphenyl ether	mg/kg	With reference to IEC 62321:2008, GC-MS	5	N.D.
Tribromodiphenyl ether	mg/kg	With reference to IEC 62321:2008, GC-MS	5	N.D.
Tetrabromodiphenyl ether	mg/kg	With reference to IEC 62321:2008, GC-MS	5	N.D.
Pentabromodiphenyl ether	mg/kg	With reference to IEC 62321:2008, GC-MS	5	N.D.
Hexabromodiphenyl ether	mg/kg	With reference to IEC 62321:2008, GC-MS	5	N.D.
Heptabromodiphenyl ether	mg/kg	With reference to IEC 62321:2008, GC-MS	5	N.D.
Octabromodiphenyl ether	mg/kg	With reference to IEC 62321:2008, GC-MS	5	N.D.
Nonabromodiphenyl ether	mg/kg	With reference to IEC 62321:2008, GC-MS	5	N.D.
Decabromodiphenyl ether	mg/kg	With reference to IEC 62321:2008, GC-MS	5	N.D.

Halogen Content
NOTE:

- (1) N.D. = Not detected (<MDL)
- (2) mg/kg = ppm
- (3) MDL = Method Detection Limit
- (4) - = No regulation
- (5) Negative = Undetectable / Positive = Detectable
- (6) ° = Qualitative analysis (No Unit)
- (7) * = Boiling-water-extraction:
 - Negative = Absence of CrVI coating
 - Positive = Presence of CrVI coating; the detected concentration in boiling-water-extraction solution is equal or greater than 0.02 mg/kg with 50 cm² sample surface area.

This document is issued by the Company subject to the General Conditions of Service which are available on our website at www.samsung.com. We undertake to provide accurate information, subject to our own conditions, for the information of our customers. The Company's sole responsibility is to its Client and this document is not intended to constitute any form of insurance policy. It is the Client's responsibility to ensure that all data is correct and complete. The Company's liability is limited to the extent of the fee. The Client's liability is limited to the extent of the fee. The Client's liability is limited to the extent of the fee. The Client's liability is limited to the extent of the fee.

SGS Korea Co., Ltd.

 922, The Gateway, 355-9, Haeje-dong, Daejeon-gu, Anyang-si, Gyeonggi-do, Korea 431-030
 +82 (0)21 4803 000 -132 (0)21 4803 059 <http://www.sgs.com>

F052 Ver4.065

Member of the SGS Group (Société Générale de Surveillance)



Test Report No. F690101/LF-CTSAYAA13-13769

Issued Date: 2013.03.22 Page 4 of 5

Testing Flow Chart for RoHS: Cd/Pb/Hg/Cr⁶⁺ /PBBs&PBDEs Testing

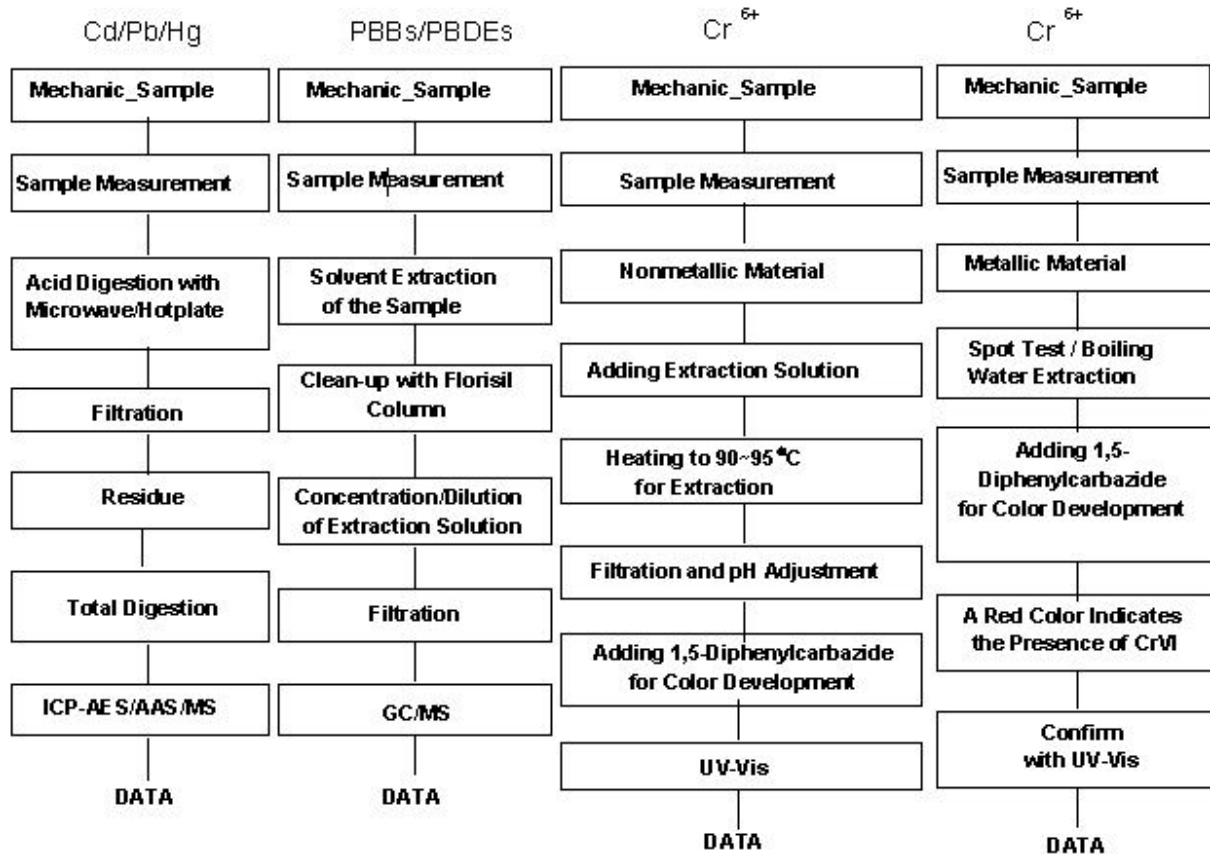

The samples were dissolved totally by pre-conditioning method according to above flow chart for Cd,Pb,Hg.
Section Chief : Gilsae Yi

NOTE:

- (1) N.D. = Not detected (<MDL)
- (2) mg/kg = ppm
- (3) MDL = Method Detection Limit
- (4) - = No regulation
- (5) Negative = Undetectable / Positive = Detectable
- (6) ^m = Qualitative analysis (No Unit)
- (7) ^s = Boiling-water-extraction:
Negative = Absence of CrVI coating
Positive = Presence of CrVI coating; the detected concentration in boiling-water-extraction solution is equal or greater than 0.02 mg/kg with 50 cm² sample surface area.

This document is issued by the Company subject to the General Conditions of Service which are available on request at http://www.samsungled.com/eng/condition_of_service.html. The Company is not responsible for the content of this document and shall not be liable for any damage or loss of data caused by the use of this document. The Company is not responsible for the content of this document and shall not be liable for any damage or loss of data caused by the use of this document.

Revision History

Date	Revision History	Writer	
		Drawn	Approved
2012.08.17	New version	I.J.PYEON	Y.T.KIM
2012.09.24	2nd version	G.E.CHO	Y.T.KIM
2012.10.26	3rd version	I.J.PYEON	Y.T.KIM
2013.02.22	4th version	I.J.PYEON	Y.T.KIM
2013.02.28	5th version	I.J.PYEON	Y.T.KIM
2013.04.19	6th version	I.J.PYEON	Y.T.KIM
2013.06.02	7th version	I.J.PYEON	Y.T.KIM
2013.06.27	8th version	I.J.PYEON	Y.T.KIM
2013.07.26	9th version	I.J.PYEON	Y.T.KIM

Looking for pricing, stock, or lifecycle information?

Click below to explore more details on WIN SOURCE:

- ⊖ [View SPHWHTL3D305E6TPJ2 on WIN SOURCE](#)
- ⊖ [Samsung Information](#)

Optimize Your Supply Chain with WIN SOURCE Solutions

- ✓ Global Sourcing Solution
- ✓ Obsolete Management
- ✓ Cost Control Management
- ✓ Shortage Management
- ✓ Alternative Solution
- ✓ Excess Inventory Management