



**THE DATASHEET OF  
SPHWH1L5N603YEV5A2**



High Power LED Series

# LH502C General

Preliminary



High efficacy and lumen makes

The LH502C suitable for Streetlight and High-bay applications

## Features & Benefits

- Operates at a maximum current of up to 880mA
- Uniform light distribution under any beam angle
- Color binning @ 85°C



## Table of Contents

1.	Characteristics	-----	3
2.	Product Code Information	-----	5
3.	Typical Characteristics Graphs	-----	9
4.	Outline Drawing & Dimension	-----	11
5.	Reliability Test Items & Conditions	-----	12
6.	Soldering Conditions	-----	13
7.	Tape & Reel	-----	14
8.	Label Structure	-----	16
9.	Packing Structure	-----	17
10.	Precautions in Handling & Use	-----	19

## 1. Characteristics

### a) Absolute Maximum Rating

Item	Symbol	Rating	Unit	Condition
Operating Temperature	$T_{opr}$	-40 ~ +85	°C	
Storage Temperature	$T_{stg}$	-40 ~ +100	°C	-
LED Junction Temperature	$T_j$	125	°C	-
Forward Current	$I_F$	880	mA	-
Peak Pulse Forward Current	$I_{FP}$	1000	mA	Duty cycle ≤ 1/10, pulse width 10ms
Soldering Temperature		260 <10	°C	-

### b) Electro-optical Characteristics ( $I_F = 640 \text{ mA}$ , $T_j = 25^\circ\text{C}$ )

Item	Unit	Rank	Min.	Typ.	Max.
Forward Voltage ( $V_F$ )	V	YE	5.9	6.2	6.3
		3	70	-	-
Color Rendering Index ( $R_a$ )	-	5	80	-	-
		7	90	-	-
Thermal Resistance (junction to chip point)	°C/W		-	3	-
Beam Angle	°		-	120	-
ESD (HBM)	kV			±4	

#### Notes:

Samsung maintains measurement tolerance of: luminous flux = ±7 %, forward voltage = ±0.1 V

c) Luminous Flux Characteristics (I<sub>F</sub> = 640 mA)

CRI (R <sub>a</sub> ) Min.	Nominal CCT (K)	Flux Rank	Flux @ T <sub>J</sub> = 25 °C (lm)		
			Min.	Typ.	Max.
70	2700K	A2	590		
	3000K	A2	620		
	3500K	A2	640		
	4000K	A2	660		
	5000K	A2	660		
	5700K	A2	650		
	6500K	A2	640		
80	2700K	A2	545		
	3000K	A2	570		
	3500K	A2	585		
	4000K	A2	600		
	5000K	A2	600		
	5700K	A2	600		
	6500K	A2	590		
90	2700K	A2	460	-	-
	3000K	A2	585	-	-
	3500K	A2	500	-	-
	4000K	A2	510	-	-
	5000K	A2	510	-	-
	5700K	A2	510	-	-
	6500K	A2	510	-	-

## Notes:

- 1) Tested in pulsed operating condition at rated test current (10 ms pulse width) and rated temperature
- 2) Samsung maintains measurement tolerance of: Luminous flux = ±7 %, CRI = ±1

## 2. Product Code Information

1	2	3	4	5	6	7	8	9	10	11	12	13	14	15	16	17	18
---	---	---	---	---	---	---	---	---	----	----	----	----	----	----	----	----	----

S P H W H 1 L 5 N 6 0 3 Y E T 5 A 2

Digit	PKG Information	Code	Specification		
1 2 3	Samsung Package High Power	SPH	High Power PKG		
4 5	Color	WH	White		
6	Product Version	1	1		
7 8	Form Factor	L5	5050 size		
9	Lens Type	N	No lens		
10	Model	6	LH502C		
11	Internal Code	0			
12	CRI	3	Min. 70		
		5	Min. 80		
		7	Min. 90		
13 14	Forward Voltage (V)	YE	<b>Bin code</b>	A0	5.9 – 6.1
			A1	6.1 – 6.3	
15	CCT (K)	W	2700K		
		V	3000K		
		U	3500K		
		T	4000K		
		R	5000K		
		Q	5700K		
		P	6500K		
16	MacAdam Step	3	MacAdam 3-Step		
		5	MacAdam 5-Step		
17 18	Luminous Flux (lm)	A2			

a) Luminous flux Rank ( I<sub>f</sub> = 640 mA, T<sub>j</sub> = 25°C )

CRI (R <sub>a</sub> ) Min.	Nominal CCT(K)	Product Code	VF Rank	Chrom Rank (Bins)	Flux		Flux Range (Φ <sub>v</sub> , lm)			
					Rank	Bins				
70	2700	SPHWH1L5N603YEW3A2	YE	W3, W5	A2	59	590-630			
		SPHWH1L5N603YEW5A2				63	630-670			
	3000	SPHWH1L5N603YEV3A2		V3, V5		61	610-650			
		SPHWH1L5N603YEV5A2				65	650-690			
	3500	SPHWH1L5N603YEU3A2		U3, U5		64	640-680			
		SPHWH1L5N603YEU5A2				68	680-720			
	4000	SPHWH1L5N603YET3A2		T3, T5		66	660-700			
		SPHWH1L5N603YET5A2				70	700-740			
	5000	SPHWH1L5N603YER3A2		R3, R5		66	660-700			
		SPHWH1L5N603YER5A2				70	700-740			
	5700	SPHWH1L5N603YEQ3A2		Q3, Q5		65	650-690			
		SPHWH1L5N603YEQ5A2				69	690-730			
	6500	SPHWH1L5N603YEP3A2		P3, P5		64	640-680			
		SPHWH1L5N603YEP5A2				68	680-720			
	80	2700		SPHWH1L5N605YEW3A2		YE	W3, W5	A2	54	540-580
				SPHWH1L5N605YEW5A2					58	580-620
3000		SPHWH1L5N605YEV3A2	V3, V5	56	560-600					
		SPHWH1L5N605YEV5A2		60	600-640					
3500		SPHWH1L5N605YEU3A2	U3, U5	58	580-620					
		SPHWH1L5N605YEU5A2		62	620-660					
4000		SPHWH1L5N605YET3A2	T3, T5	60	600-640					
		SPHWH1L5N605YET5A2		64	640-680					
5000		SPHWH1L5N605YER3A2	R3, R5	60	600-640					
		SPHWH1L5N605YER5A2		64	640-680					
5700		SPHWH1L5N605YEQ3A2	Q3, Q5	60	600-640					
		SPHWH1L5N605YEQ5A2		64	640-680					
6500		SPHWH1L5N605YEP3A2	P3, P5	59	590-630					
		SPHWH1L5N605YEP5A2		63	630-670					
90		2700	SPHWH1L5N607YEW3A2	YE	W3, W5		A2		45	450-490
			SPHWH1L5N607YEW5A2						49	490-530
	3000	SPHWH1L5N607YEV3A2	V3, V5		47	470-510				
		SPHWH1L5N607YEV5A2			51	510-550				
	3500	SPHWH1L5N607YEU3A2	U3, U5		49	490-530				
		SPHWH1L5N607YEU5A2			53	530-570				
	4000	SPHWH1L5N607YET3A2	T3, T5		50	500-540				
		SPHWH1L5N607YET5A2			54	540-580				
	5000	SPHWH1L5N607YER3A2	R3, R5		50	500-540				
		SPHWH1L5N607YER5A2			54	540-580				
	5700	SPHWH1L5N607YEQ3A2	Q3, Q5		50	500-540				
		SPHWH1L5N607YEQ5A2			54	540-580				

b) Voltage Bins (  $I_f = 640 \text{ mA}$ ,  $T_j = 25^\circ\text{C}$  )

Nominal CCT (K)	CRI (R <sub>a</sub> ) Min.	Product Code	Voltage Rank	Voltage Bin	Voltage Range (V)
-	-	-	YE	A0	5.9 - 6.1
				A1	6.1 - 6.3

PRELIMINARY

### c) Chromaticity Region & Coordinates ( $I_F = 640 \text{ mA}$ , $T_J = 85^\circ\text{C}$ )

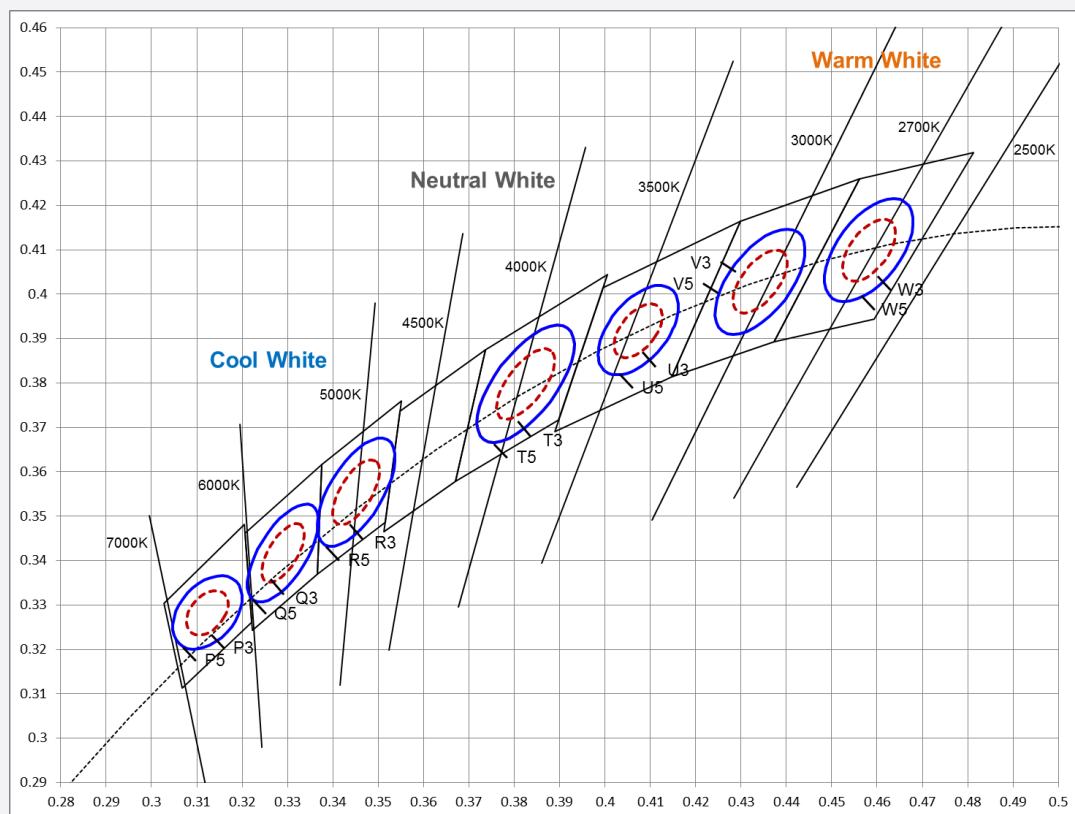

CRI	CCT	Rank	CIE x	CIE y	$\Phi$	A	b
70	2700K	W3	0.4578	0.4101	53.7	0.0081	0.0042
		W5				0.0135	0.0070
80	3000K	V3	0.4338	0.4030	53.2	0.0083	0.0041
		V5				0.0138	0.0068
90	3500K	U3	0.4073	0.3917	54.0	0.0093	0.0041
		U5				0.0155	0.0069
70	4000K	T3	0.3818	0.3797	53.7	0.0094	0.0040
		T5				0.0157	0.0067
80	5000K	R3	0.3447	0.3553	59.6	0.0082	0.0035
		R5				0.0137	0.0058
90	5700K	Q3	0.3287	0.3417	59.1	0.0094	0.0040
		Q5				0.0157	0.0067
70	6500K	P3	0.3123	0.3282	58.6	0.0067	0.0029
		P5				0.0112	0.004

Note : Samsung maintains measurement tolerance of:  $C_x, C_y = \pm 0.005$

### 3. Typical Characteristic Graphs

a) Spectral Distribution ( $I_F = 640 \text{ mA}$ ,  $T_j = 25^\circ\text{C}$ )



b) Forward Current Characteristics ( $T_j = 25^\circ\text{C}$ )



### c) Temperature Characteristics ( $I_f = 640 \text{ mA}$ )



### d) Color Shift Characteristics ( $I_f = 640 \text{ mA}$ , $T_j = 25^\circ\text{C}$ )

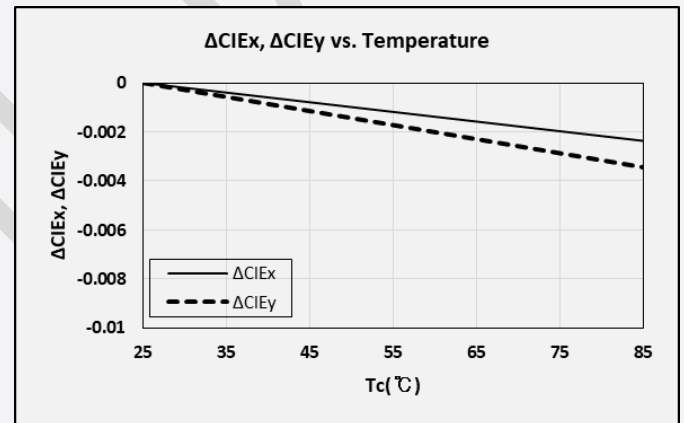
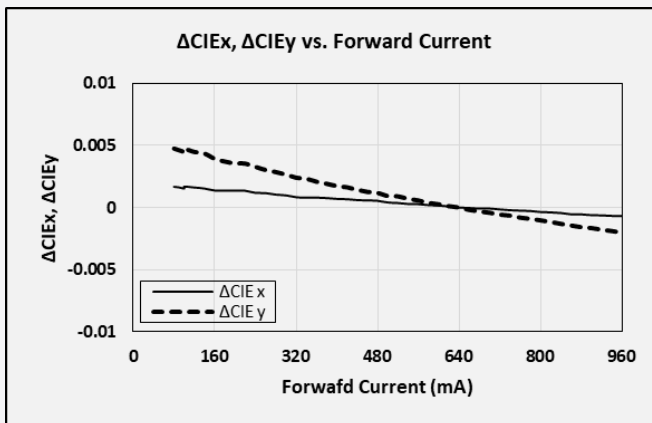

### e) Beam Angle Characteristics ( $I_f = 640 \text{ mA}$ , $T_j = 25^\circ\text{C}$ )



## 4. Outline Drawing & Dimension

### a) Mechanical Dimensions



#### Notes:

- 1) Mark for the Anode
- 2) Unit : mm
- 3) Tolerance :  $\pm 0.1\text{mm}$

### b) Recommended Solder Pad



## 5. Reliability Test Items & Conditions

### a) Test Items

Test Item	Test Condition	Test Hour / Cycle
High Temperature Operating Life Test	85°C, DC Derating, $I_F$	1000 h
Wet High Temperature Operating Life Test	60°C, 90 % RH, DC Derating, $I_F$	1000 h
Low Temperature Operating Life Test	-40°C, DC Derating $I_F$	1000 h
High Temperature Storage	120°C	1000 h
Low Temperature Storage	-40°C	1000 h
Wet High Temperature Storage		1000h
Powered Temperature Cycle		100 cycles
Temperature Cycling	Temperature range / 15min Temperature range within 5min	500 cycles
ESD (HBM)	R <sub>1</sub> : 10 MΩ R <sub>2</sub> : 1.5 kΩ C: 100 pF V: ±2 kV	5 times
Vibration Test	20~ 80 Hz (displacement: 0.06 inch, max. 20 g) 80 ~ 2 kHz (max. 20 g) min. frequency ↔ max. frequency 4 min transfer	4 times
Mechanical Shock Test	1500g, 0.5 ms each of the 6 surfaces (3 axis x 2 sides)	5 times

### b) Criteria for Judging the Damage

Item	Symbol	Test Condition ( $T_c = 25^\circ\text{C}$ )	Limit	
			Min.	Max.
Forward Voltage	$V_F$	$I_F = \text{Sorting Current}$	L.S.L. * 0.9	U.S.L. * 1.1
Luminous Flux	$\Phi_v$	$I_F = \text{Sorting Current}$	L.S.L * 0.7	U.S.L * 1.3

## 6. Soldering Conditions

### a) Reflow Conditions (Pb free)

Reflow frequency: 2 times max.



### b) Manual Soldering Conditions

Not more than 5 seconds @ max. 300°C, under soldering iron.

## 7. Tape & Reel

### a) Taping Dimension

(unit: mm)

symbol	AO	BO	KO	PO	P1	P2
Spec	5.20±0.10	5.40±0.10	0.95±0.10	4.00±0.10	8.0±0.10	2.0±0.10
symbol	W	T	E	F	DO	D1
Spec	12.0±0.2	0.20±0.05	1.75±0.10	5.50±0.05	150+0.1/-0	1.50±0.10

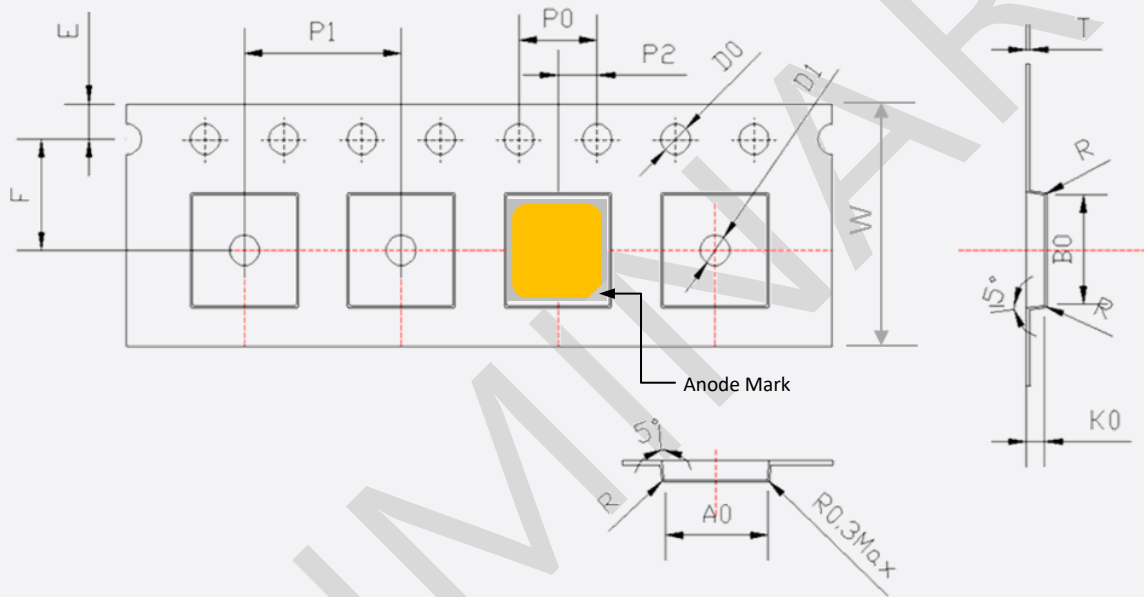

Taping Direction

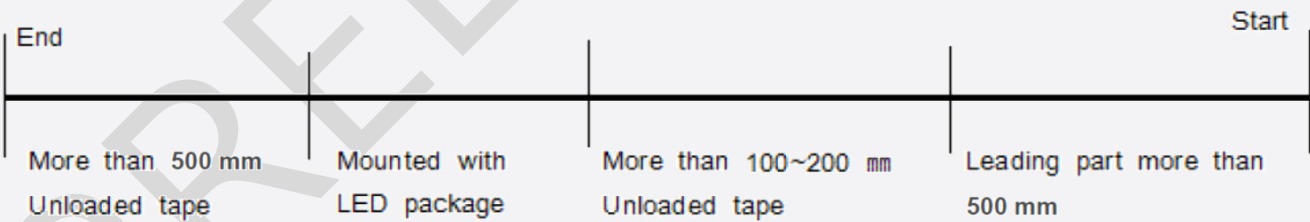

## b) Reel Dimension (max 2,000 pcs)

(unit: mm)

**Notes:**

- 1) Quantity: The quantity/reel is 2000 pcs
- 2) All dimensions are millimeters (Tolerance :  $\pm 0.2$ mm)
- 3) Packaging : P/N, Manufacturing data code no. and quantity are indicated on the aluminum packing bag.

## 8. Label Structure

### a) Label Structure



Note: Denoted bin code and product code above is only an example (see description on page 5)

Bin Code:

- ⒶⒷ: Forward Voltage bin (refer to page 8)
- ⒸⒹ: Chromaticity bin (refer to page 9)
- ⒺⒻ: Luminous Flux bin (refer to page 7)

### b) Lot Number

The lot number is composed of the following characters:

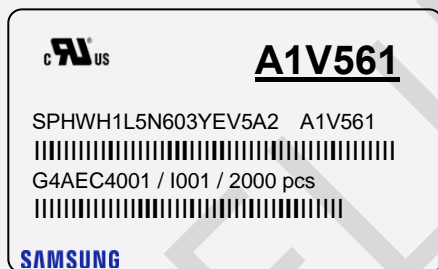

①②③④⑤⑥⑦⑧⑨ / IⒶⒷⒸ / xxxx pcs

- ①② : Production site (G4 : Guangzhou ,China)
- ③ : Product state (A: Normal, B: Bulk, C: First Production, R: Reproduction, S: Sample)
- ④ : Year (D:2019, E:2020, F:2021 ... )
- ⑤ : Month (1-9, A, B, C)
- ⑥ : Day (1-9, A, B-V)
- ⑦⑧⑨ : Samsung Electronics Product serial number (001 - 999)
- ⒶⒷⒸ : Reel number(001 - 999)

### 9. Packing Structure

#### a) Packing Process

##### Reel

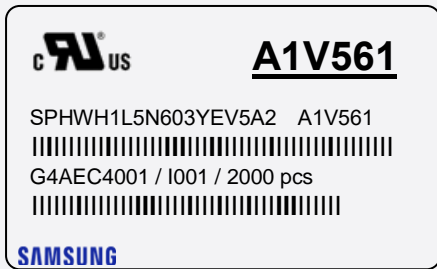

##### Desiccant



##### Aluminum Vinyl Packing Bag

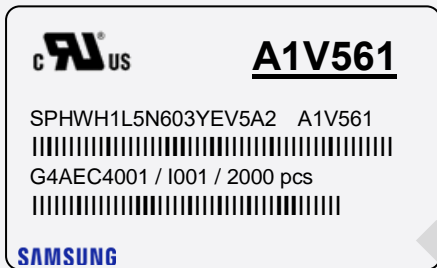

Contains up to 2 bags

##### Inner Box

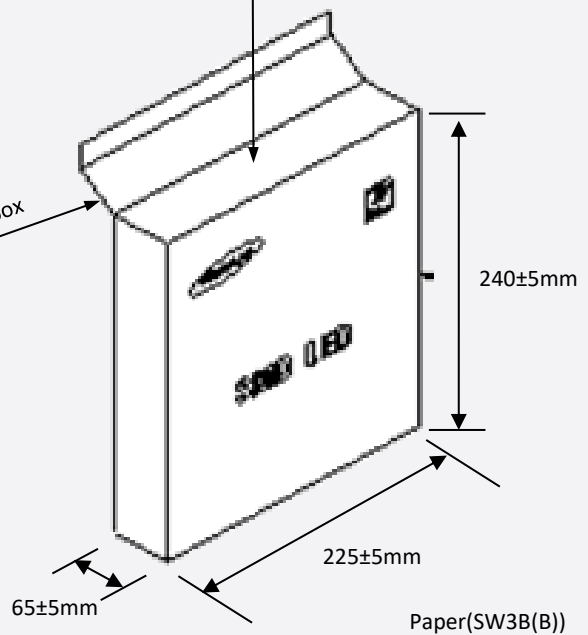
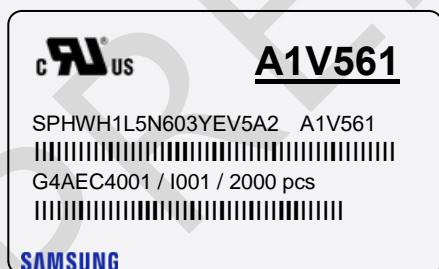

b) Aluminum Vinyl Packing Bag



**CAUTION**

This bag contains  
**MOISTURE SENSITIVE DEVICES**

**LEVEL**  
**2a**

1. Shelf life in sealed bag: 12 months at < 40°C and < 90% relative humidity (RH)
2. Peak package body temperature: 240 °C
3. After this bag is opened, devices that will be subjected to reflow solder or other high temperature processes must be:
  - a. Mounted within 672 hours at factory conditions of equal to or less than 30°C / 60% RH, or
  - b. Stored at < 10% RH
4. Devices require bake, before mounting, if:
  - a. Humidity Indicator Card is > 60% when read at 23±5°C, or
  - b. 2a is not met.
5. If baking is required, devices must be baked for 10 ~ 24 hours at 60±5°C

Note: If device containers cannot be subjected to high temperature or shorter bake times are desired, reference IPC/JEDEC J-STD-033 for bake procedure.

Bag seal due date: \_\_\_\_\_  
(If blank, see code label)

Note: Level and body temperature by IPC/JEDEC J-STD-020



**A1V561**

SPHWH1L5N603YEV5A2 A1V561  
 |||  
 G4AEC4001 / I001 / 2000 pcs  
 |||

**SAMSUNG**



**ATTENTION**

OBSEVE PRECAUTIONS  
FOR HANDLING  
ELECTROSTATIC  
SENSITIVE  
DEVICES



**■ 주의 사항**

이 알루미늄 지퍼 백은 습기 및 정전기로부터 제품을 보호하기 위하여 제작되었습니다. 개봉 후에는 즉시 솔더 작업을 실시하는 것을 권장합니다.

습기 및 정전기로부터 제품을 보호 하기 위해서 개봉 후 사용하지 않는 자재는 본 팩에 넣어 보관 하시기 바랍니다. 사용하지 않는 자재를 본 팩에 넣을 때는 반드시 동봉된 드라이 팩과 함께 넣고 지퍼부분을 완전하게 밀봉하여 주시기 바랍니다.

**■ Important**

This Al Zipper bag is designed to protect the enclosed products from moisture and ESD. Once opened, the products should be soldered onto the printed circuit board immediately. When not in use, please do not leave the products unprotected by the Al Zipper Bag. To repack unused products, please ensure the zip-lock is completely sealed with the dry pack left inside.

c) Silica Gel & Humidity Indicator Card inside Aluminum Vinyl Bag

(This image is for reference only. Silicagel and humidity indicator shapes may be different.)



**HUMISAFE™**

10%    20%    30%    40%    50%    60%



READ AT TOP OF GREEN COLOR  
CHANGE BETWEEN YELLOW AND GREEN

Warning If Green  
Change Desiccant

**HUMIDITY INDICATOR  
COBALT-FREE**

GP&E Co., Ltd.  
6CF-60NS

## 10. Precautions in Handling & Use

- 1) For over-current protection, users are recommended to apply resistors connected in series with the LEDs to mitigate sudden change of the forward current caused by shift of forward voltage.
- 2) This device should not be used in any type of fluid such as water, oil, organic solvent, etc. When cleaning is required, IPA is recommended as the cleaning agent. Some solvent-based cleaning agent may damage the silicone resins used in the device.
- 3) When the device is in operation, the forward current should be carefully determined considering the maximum ambient temperature and corresponding junction temperature.
- 4) LEDs must be stored in a clean environment. If the LEDs are to be stored for three months or more after being shipped from Samsung, they should be packed with a nitrogen-filled container (shelf life of sealed bags is 12 months at temperature 0~40°C, 0~90 % RH).
- 5) After storage bag is opened, device subjected to soldering, solder reflow, or other high temperature processes must be:
  - a. Mounted within 672 hours (28 days) at an assembly line with a condition of no more than 30°C / 60 % RH, or
  - b. Stored at <10 % RH
- 6) Repack unused devices with anti-moisture packing, fold to close any opening and then store in a dry place.
- 7) Devices require baking before mounting, if humidity card reading is >60 % at 23 ± 5°C
- 8) Devices must be baked for 1 hour at 60 ± 5°C, if baking is required.
- 9) The LEDs are sensitive to the static electricity and surge current. It is recommended to use a wrist band or anti-electrostatic glove when handling the LEDs. If voltage exceeding the absolute maximum rating is applied to LEDs, it may cause damage or even destruction to LED devices. Damaged LEDs may show some unusual characteristics such as increase in leakage current, lowered turn-on voltage, or abnormal lighting of LEDs at low current.
- 10) VOCs (Volatile Organic Compounds) can be generated from adhesives, flux, hardener or organic additives used in luminaires (fixtures). Transparent LED silicone encapsulant is permeable to those chemicals and they may lead to a discoloration of encapsulant when they exposed to heat or light. This phenomenon can cause a significant loss of light emitted (output) from the luminaires. In order to prevent these problems, we recommend users to know the physical properties of materials used in luminaires and they must be carefully selected.
- 11) Risk of sulfurization (or tarnishing)  
The LED from Samsung Electronics Co., Ltd. uses a silver-plated lead frame and its surface color may change to black (or dark colored) when it is exposed to sulfur (S), chlorine (Cl) or other halogen compound. Sulfurization of lead frame may cause intensity degradation, change of chromaticity coordinates and, in extreme cases, open circuit. It requires caution. Due to possible sulfurization of lead frame, LED should not be used and stored together with oxidizing substances made of materials such as: rubber, plain paper, lead solder cream, etc.

# Legal and additional information.

## [About Samsung Electronics Co., Ltd.](#)

Samsung Electronics Co., Ltd. inspires the world and shapes the future with transformative ideas and technologies, redefining the worlds of TVs, smartphones, wearable devices, tablets, cameras, digital appliances, printers, medical equipment, network systems and semiconductors.

We are also leading in the Internet of Things space through, among others, our Digital Health and Smart Home initiatives. We employ 307,000 people across 84 countries. To discover more, please visit our official website at [www.samsung.com](http://www.samsung.com) and our official blog at [global.samsungtomorrow.com](http://global.samsungtomorrow.com).

Copyright © 2020 Samsung Electronics Co., Ltd. All rights reserved.

Samsung is a registered trademark of Samsung Electronics Co., Ltd.

Specifications and designs are subject to change without notice. Non-metric weights and measurements are approximate. All data were deemed correct at time of creation. Samsung is not liable for errors or omissions. All brand, product, service names and logos are trademarks and/or registered trademarks of their respective owners and are hereby recognized and acknowledged.

Samsung Electronics Co., Ltd.

95, Samsung 2-ro

Giheung-gu

Yongin-si, Gyeonggi-do, 446-711

KOREA

[www.samsungled.com](http://www.samsungled.com)

**SAMSUNG**

## Looking for pricing, stock, or lifecycle information?

Click below to explore more details on WIN SOURCE:

- ⊖ [View SPHWH1L5N603YEV5A2 on WIN SOURCE](#)
- ⊖ [Samsung Information](#)

## Optimize Your Supply Chain with WIN SOURCE Solutions

- ✓ Global Sourcing Solution
- ✓ Obsolete Management
- ✓ Cost Control Management
- ✓ Shortage Management
- ✓ Alternative Solution
- ✓ Excess Inventory Management