



**THE DATASHEET OF  
SPHWH1L5N403XEV5A1**



## High Power LED Series

# LH508A

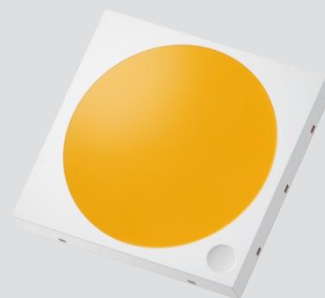

High efficacy and lumen makes the LH508A suitable use in a broad range of applications

### Features & Benefits

- Operates at a maximum current of up to 0.24A (XE rank) / 0.96A (GB rank)
- Uniform light distribution under any beam angle
- CIE Hot binning @ 85 °C



## Table of Contents

1.	Characteristics	-----	3
2.	Product Code Information	-----	5
3.	Typical Characteristics Graphs	-----	10
4.	Outline Drawing & Dimension	-----	13
5.	Reliability Test Items & Conditions	-----	14
6.	Soldering Conditions	-----	15
7.	Tape & Reel	-----	16
8.	Label Structure	-----	18
9.	Packing Structure	-----	19
10.	Precautions in Handling & Use	-----	22

## 1. Characteristics

### a) Absolute Maximum Rating

Item	Symbol	Rating	Unit	Condition
Operating Temperature	$T_{opr}$	-40 ~ +85	°C	
Storage Temperature	$T_{stg}$	-40 ~ +85	°C	-
LED Junction Temperature	$T_j$	125	°C	-
Forward Current	$I_F$	240 (24V)	mA	XE Rank, 8 chips in series
		960 (6V)		GB Rank, 2 chips in series 4 chips in parallel
Peak Pulse Forward Current	$I_{FP}$	300 (24V)	mA	Duty cycle ≤ 1/10, pulse width 100µm
		1200 (6V)		
Soldering Temperature		260 <10	°C s	-

### b) Electro-optical Characteristics( $T_j = 25\text{ °C}$ )

Item	Unit	Rank	Min.	Typ.	Max.
Forward Voltage ( $V_f$ )	V	XE	23.5	24.5	26.5
		GB	5.8	6.1	6.7
Color Rendering Index ( $R_a$ )	-	3	70	-	-
		5	80		
		7	90		
Thermal Resistance (junction to chip point)	°C/W		-	1.9	-
Beam Angle	°		-	116	-
Nominal Power	W			3.9	
ESD (HBM)	kV			±4	

#### Notes:

- 1) Samsung maintains measurement tolerance of: luminous flux =  $\pm 7\%$ , forward voltage =  $\pm 0.1\text{ V}$
- 2) Characteristics @ 25 °C are for reference only

**c) Luminous Flux Characteristics (  $I_F = 160 \text{ mA}^{(3)}$  /  $640 \text{ mA}^{(3)}$  )**

CRI (R <sub>s</sub> ) Min.	Nominal CCT (K)	Flux Rank	Flux Bin	Flux @ T <sub>J</sub> = 25 °C (lm)		
				Min.	Typ.	Max.
70	3000K	-	-	521	572	-
	4000K	-	-	558	610	-
	5000K	-	-	558	610	-
	5700K	-	-	558	610	-
	6500K	-	-	558	610	-
80	2700K	-	-	459	504	-
	3000K	-	-	473	520	-
	4000K	-	-	521	550	-
	5000K	-	-	521	550	-
	5700K	-	-	521	550	-
90	6500K	-	-	521	550	-
	2700K	-	-	402	429	-
	3000K	-	-	416	444	-
	4000K	-	-	443	473	-

**Notes:**

- 1) The LED is tested in pulsed operating condition at rated test current (10 ms pulse width) and rated temperature (T<sub>J</sub> = T<sub>C</sub> = 25 °C).
- 2) Samsung maintains measurement tolerance of: Luminous flux = ±7 %, CRI = ±1
- 3) If=160mA is for XE rank, and If=640mA for GB rank.

## 2. Product Code Information

1	2	3	4	5	6	7	8	9	10	11	12	13	14	15	16	17	18
S	P	H	W	H	1	L	5	N	4	0	3	X	E	W	3	A	1

Digit	PKG Information	Code	Specification
1 2 3	Samsung Package High Power	<b>SPH</b>	
4 5	Color	<b>WH</b>	White
6	Product Version	<b>1</b>	
7 8	Form Factor	<b>L5</b>	5050 size
9	Lens Type	<b>N</b>	No lens
10	Wattage or Model	<b>4</b>	LH508A
11	Internal Code	<b>0</b>	
12	CRI & Sorting Temperature	<b>3</b>	Min. 70 (25°C)
		<b>5</b>	Min. 80 (25°C)
		<b>7</b>	Min. 90 (25°C)
13 14	Forward Voltage (V)	<b>XE</b>	23.5~26.5V
		<b>GB</b>	5.8~6.7
15	CCT (K)	<b>W</b>	2700K
		<b>V</b>	3000K
		<b>U</b>	3500K
		<b>T</b>	4000K
		<b>R</b>	5000K
		<b>Q</b>	5700K
		<b>P</b>	6500K
16	MacAdam Step	<b>3</b>	MacAdam 3-step
17 18	Luminous Flux	<b>A1</b>	A1 Flux binning

a) Binning Structure (I<sub>F</sub> = 160 mA)

CRI (R <sub>a</sub> ) Min.	Nominal CCT (K)	Product Code	V <sub>F</sub> Rank (T <sub>J</sub> =25°C)	Chrom. Bin (T <sub>J</sub> =85°C)	Flux Rank	Flux Range (Φ <sub>v</sub> , lm) (T <sub>J</sub> =25°C)
90	2700	SPHWH1L5N407XEW3A1	XE	W3	A1	402~
		SPHWH1L5N407XEW5A1		W5		
	3000	SPHWH1L5N407XEV3A1	XE	V3	A1	416~
		SPHWH1L5N407XEV5A1		V5		
	4000	SPHWH1L5N407XET3A1	XE	T3	A1	443~
		SPHWH1L5N407XET5A1		T5		
80	2700	SPHWH1L5N405XEW3A1	XE	W3	A1	459~
		SPHWH1L5N405XEW5A1		W5		
	3000	SPHWH1L5N405XEV3A1	XE	V3	A1	473~
		SPHWH1L5N405XEV5A1		V5		
	4000	SPHWH1L5N405XET3A1	XE	T3	A1	521~
		SPHWH1L5N405XET5A1		T5		
	5000	SPHWH1L5N405XER3A1	XE	R3	A1	521~
		SPHWH1L5N405XER5A1		R5		
	5700	SPHWH1L5N403XEQ3A1	XE	Q3	A1	521~
		SPHWH1L5N403XEQ5A1		Q5		
	6500	SPHWH1L5N403XEP3A1	XE	P3	A1	521~
		SPHWH1L5N403XEP5A1		P5		
70	3000	SPHWH1L5N403XEV3A1	XE	V3	A1	521~
		SPHWH1L5N403XEV5A1		V5		
	4000	SPHWH1L5N403XET3A1	XE	T3	A1	558~
		SPHWH1L5N403XET5A1		T5		
	5000	SPHWH1L5N403XER3A1	XE	R3	A1	558~
		SPHWH1L5N403XER5A1		R5		
	5700	SPHWH1L5N403XEQ3A1	XE	Q3	A1	558~
		SPHWH1L5N403XEQ5A1		Q5		
	6500	SPHWH1L5N403XEP3A1	XE	P3	A1	558~
		SPHWH1L5N403XEP5A1		P5		

b) Binning Structure (I<sub>F</sub> = 640 mA)

CRI (R <sub>a</sub> ) Min.	Nominal CCT (K)	Product Code	V <sub>F</sub> Rank (T <sub>J</sub> =25°C)	Chrom. Bin (T <sub>J</sub> =85°C)	Flux Rank	Flux Range (Φ <sub>v</sub> , lm) (T <sub>J</sub> =25°C)
90	2700	SPHWH1L5N407GBW3A1	GB	W3	A1	402~
		SPHWH1L5N407GBW5A1		W5		
	3000	SPHWH1L5N407GBV3A1	GB	V3	A1	416~
		SPHWH1L5N407GBV5A1		V5		
	4000	SPHWH1L5N407GBT3A1	GB	T3	A1	443~
		SPHWH1L5N407GBT5A1		T5		
80	2700	SPHWH1L5N405GBW3A1	GB	W3	A1	459~
		SPHWH1L5N405GBW5A1		W5		
	3000	SPHWH1L5N405GBV3A1	GB	V3	A1	473~
		SPHWH1L5N405GBV5A1		V5		
	4000	SPHWH1L5N405GBT3A1	GB	T3	A1	521~
		SPHWH1L5N405GBT5A1		T5		
	5000	SPHWH1L5N405GBR3A1	GB	R3	A1	521~
		SPHWH1L5N405GBR5A1		R5		
	5700	SPHWH1L5N403GBQ3A1	GB	Q3	A1	521~
		SPHWH1L5N403GBQ5A1		Q5		
	6500	SPHWH1L5N403GBP3A1	GB	P3	A1	521~
		SPHWH1L5N403GBP5A1		P5		
70	3000	SPHWH1L5N403GBV3A1	GB	V3	A1	521~
		SPHWH1L5N403GBV5A1		V5		
	4000	SPHWH1L5N403GBT3A1	GB	T3	A1	558~
		SPHWH1L5N403GBT5A1		T5		
	5000	SPHWH1L5N403GBR3A1	GB	R3	A1	558~
		SPHWH1L5N403GBR5A1		R5		
	5700	SPHWH1L5N403GBQ3A1	GB	Q3	A1	558~
		SPHWH1L5N403GBQ5A1		Q5		
	6500	SPHWH1L5N403GBP3A1	GB	P3	A1	558~
		SPHWH1L5N403GBP5A1		P5		

**c) Voltage Bins (  $I_F = 160 \text{ mA}^1$  /  $640 \text{ mA}^1$ ,  $T_j = 25 \text{ }^\circ\text{C}$  )**

Nominal CCT (K)	CRI (R <sub>a</sub> ) Min.	Product Code	Voltage Rank	Voltage Bin	Voltage Range (V)
-	-	-	XE	D1	23.5 ~ 24.5
-	-	-		E1	24.5 ~ 25.5
-	-	-		F1	25.5 ~ 26.5
-	-	-	GB	B1	5.8 ~ 6.1
-	-	-		B2	6.1 ~ 6.4
-	-	-		B3	6.4 ~ 6.7

**Notes:**

- 1)  $I_F=160\text{mA}$  is for XE rank, and  $I_F=640\text{mA}$  for GB rank.
- 2) ☆☆ stands for Vf rank, which can be GB or XE.
- 3) ○ stands for tolerance on chromaticity binning, which can be 3 or 5.

d) Chromaticity Region & Coordinates ( $I_f = 160 \text{ mA}$ ,  $T_J = 85^\circ\text{C}$ )

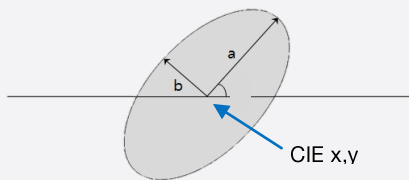
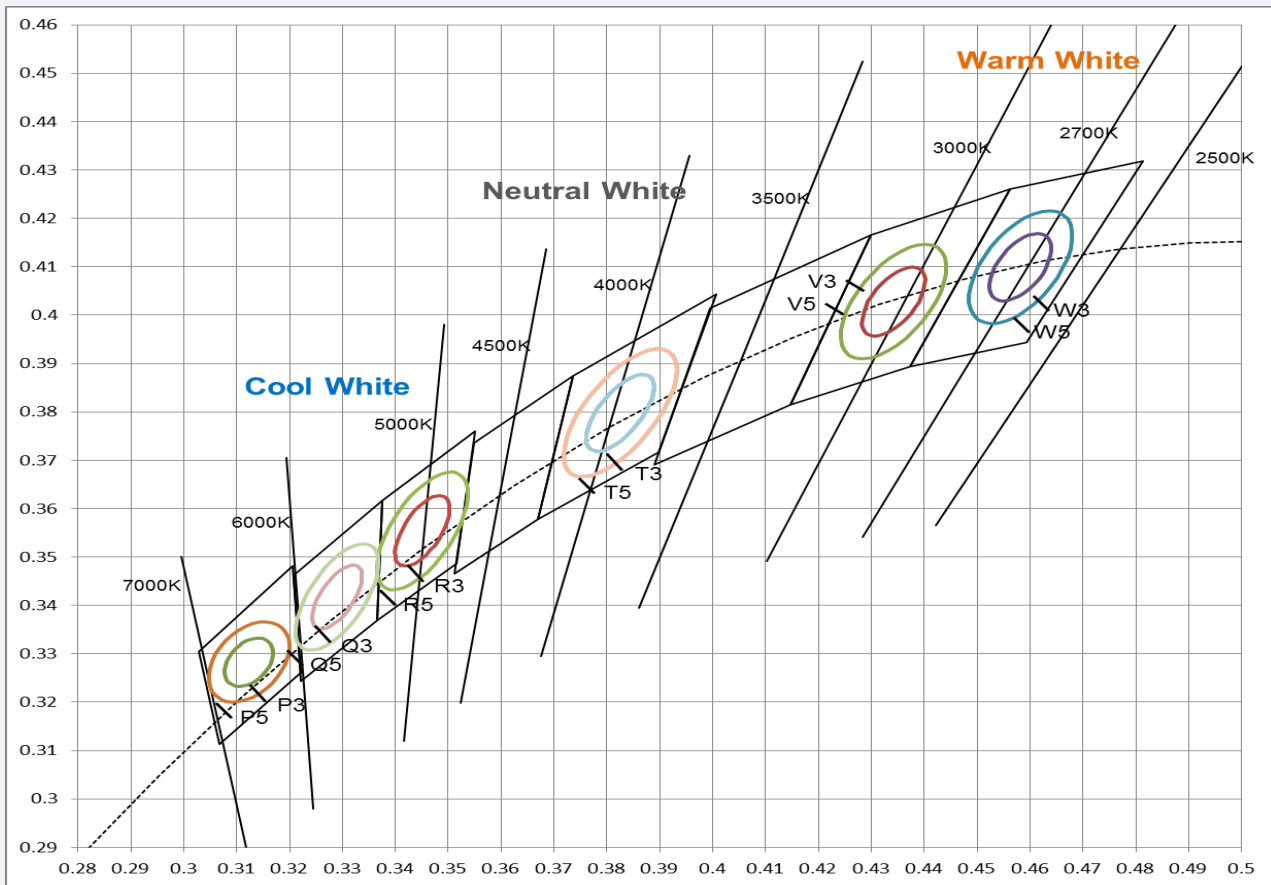

CRI	CCT	Rank	CIE y	CIE x	q	a	b
CRI70+ CRI80+ CRI90+	2700K	W3	0.4101	0.4578	53.7	0.0081	0.0042
		W5	0.4101	0.4578	53.7	0.0135	0.0070
	3000K	V3	0.4030	0.4338	53.2	0.0083	0.0041
		V5	0.4030	0.4338	53.2	0.0138	0.0068
	4000K	T3	0.3797	0.3818	53.7	0.0094	0.0040
		T5	0.3797	0.3818	53.7	0.0157	0.0067
	5000K	R3	0.3553	0.3447	59.6	0.0082	0.0035
		R5	0.3553	0.3447	59.6	0.0137	0.0058
	5700K	Q3	0.3417	0.3287	59.1	0.0075	0.0032
		Q5	0.3417	0.3287	59.1	0.0125	0.0053
	6500K	P3	0.3282	0.3123	58.6	0.0067	0.0029
		P5	0.3282	0.3123	58.6	0.0112	0.0048

### 3. Typical Characteristic Graphs

#### a) Spectrum Distribution ( $I_f = 160 \text{ mA}$ , $T_j = 25 \text{ }^\circ\text{C}$ )

CCT : 4000K (70 CRI)

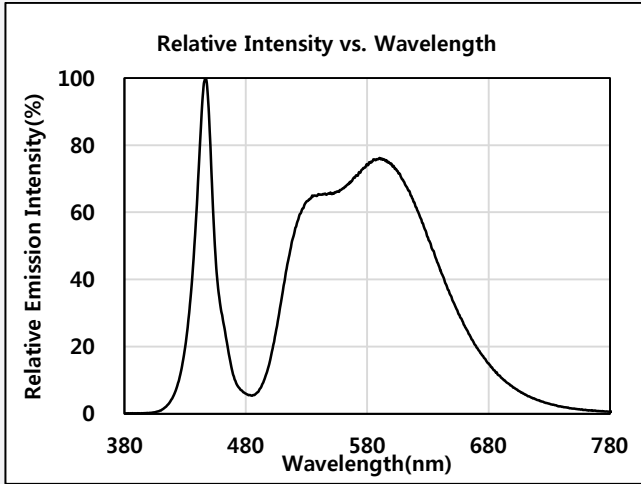

CCT : 5000K (70 CRI)

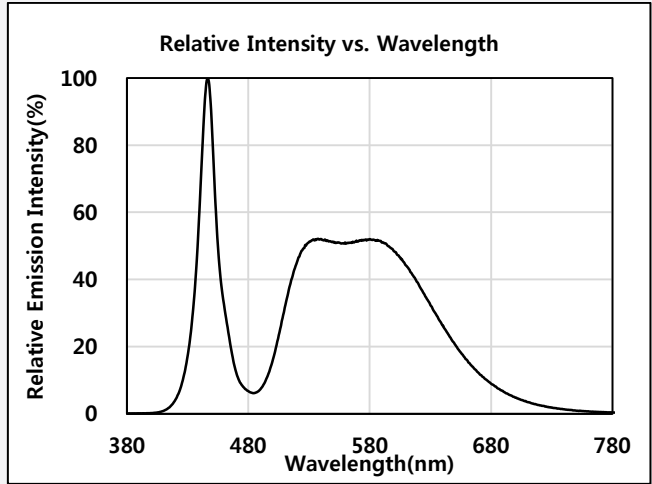

CCT : 3000K (80 CRI)

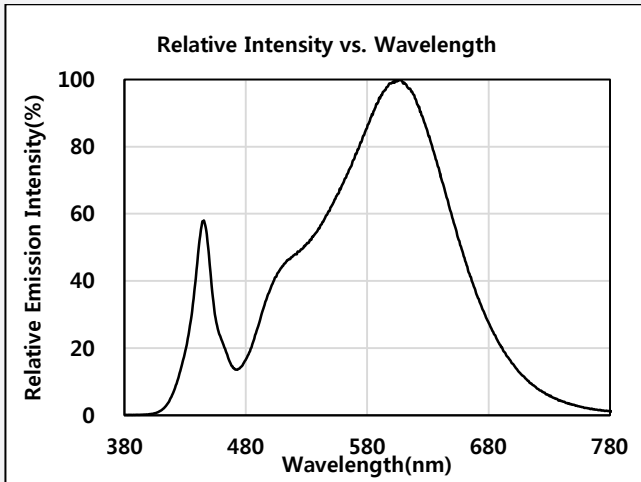

CCT : 4000K (80 CRI)

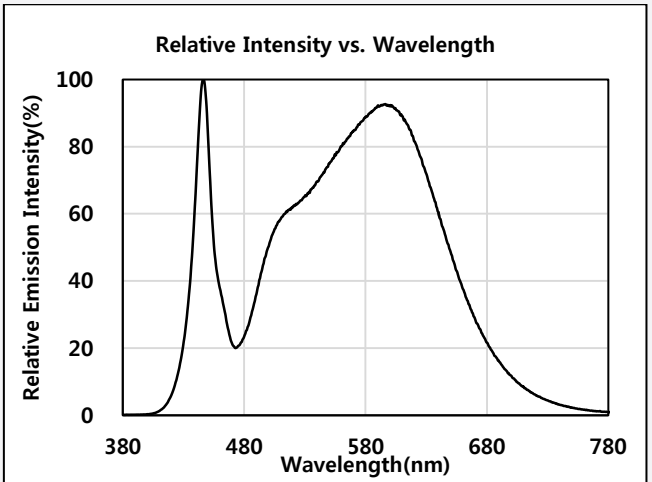

CCT : 5000K (80 CRI)

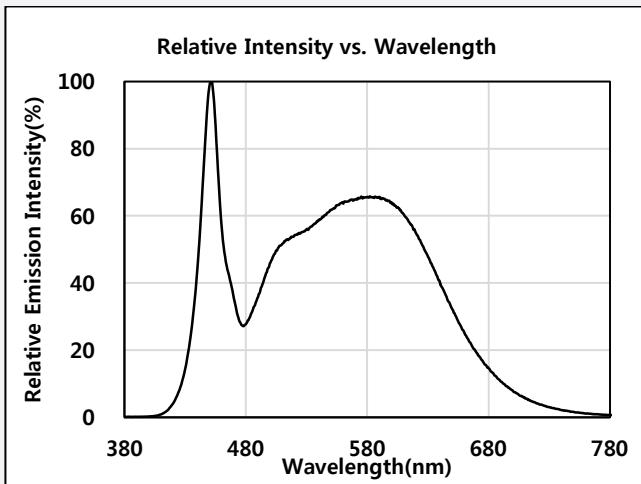

CCT : 3000K (90 CRI)

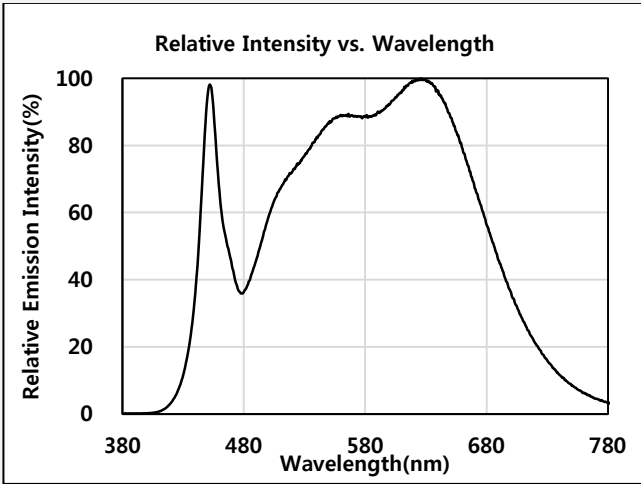

CCT : 4000K (90 CRI)

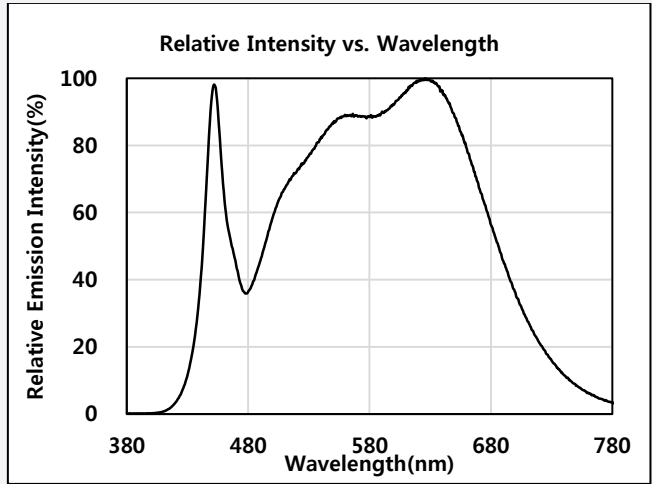

b) Forward Current Characteristics ( $T_J = 25^\circ\text{C}$ )

XE Rank : 24V

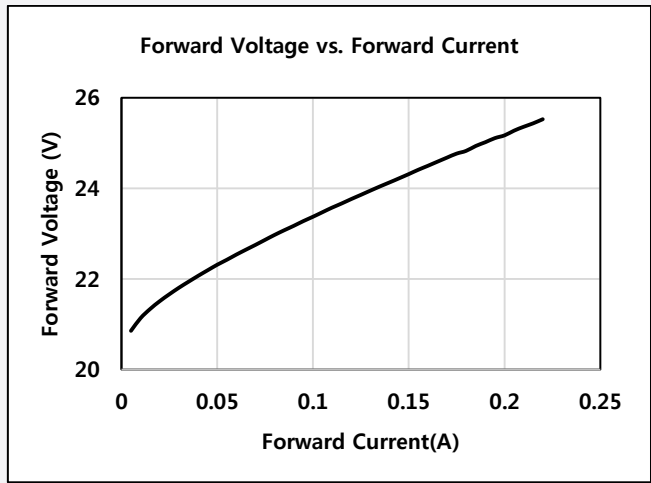
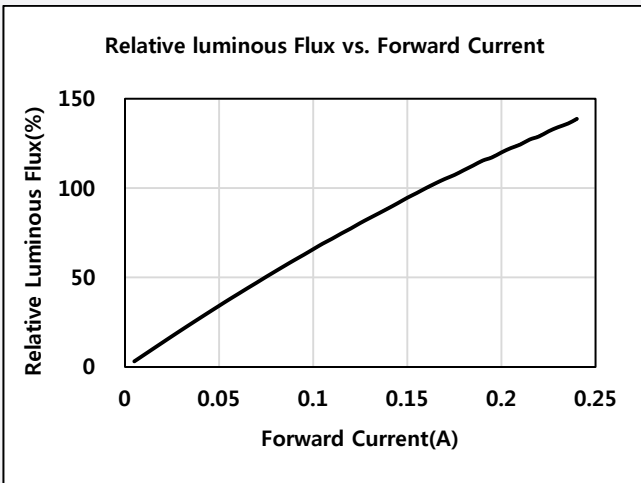

GB Rank : 6V

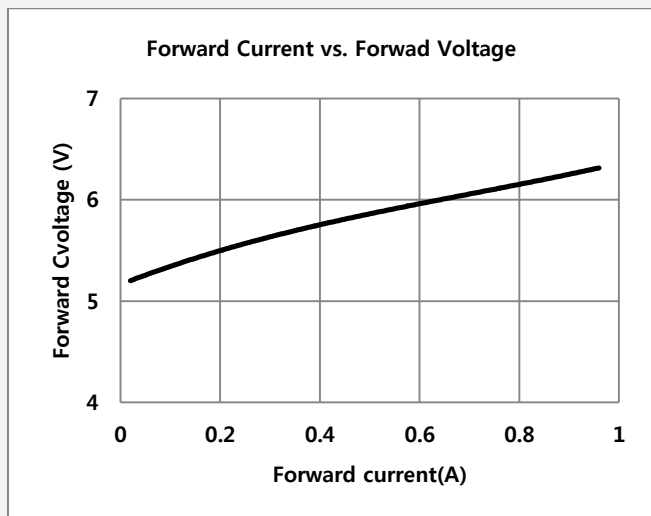
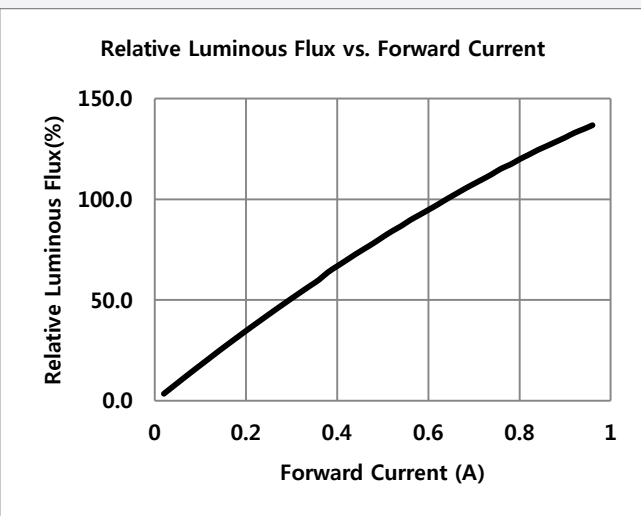

c) Temperature Characteristics ( $I_f = 160 \text{ mA}$ )

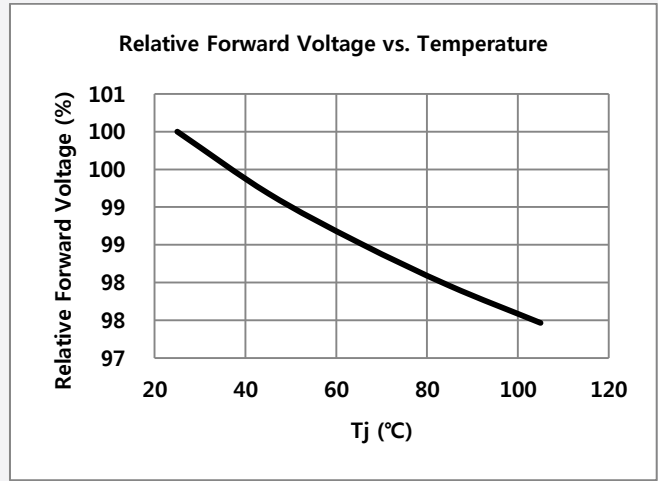
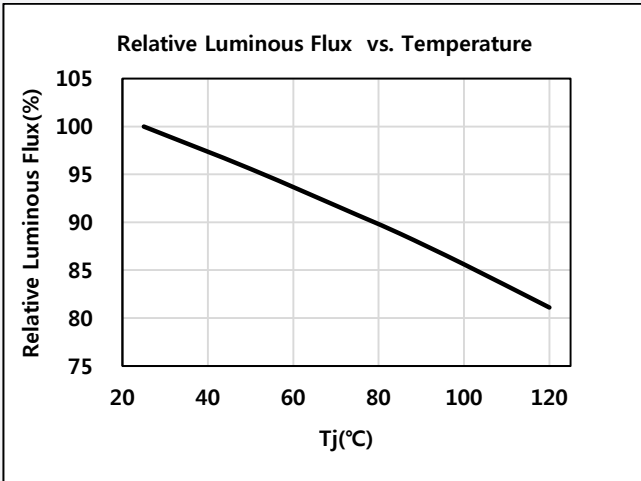

d) Color Shift Characteristics ( $I_f = 160 \text{ mA}$ ,  $T_j = 25 \text{ °C}$ )

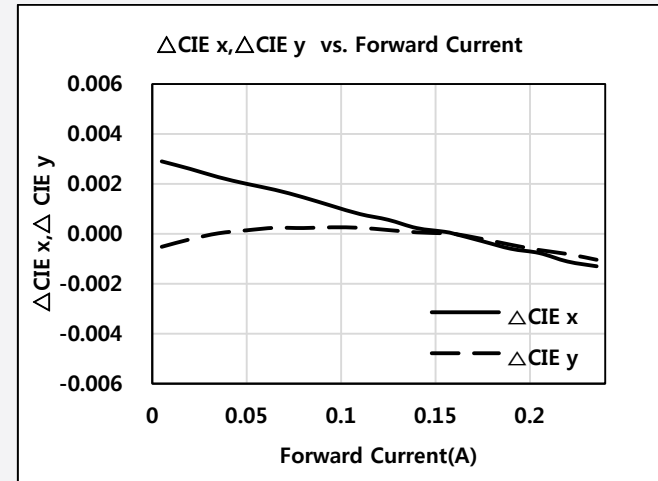
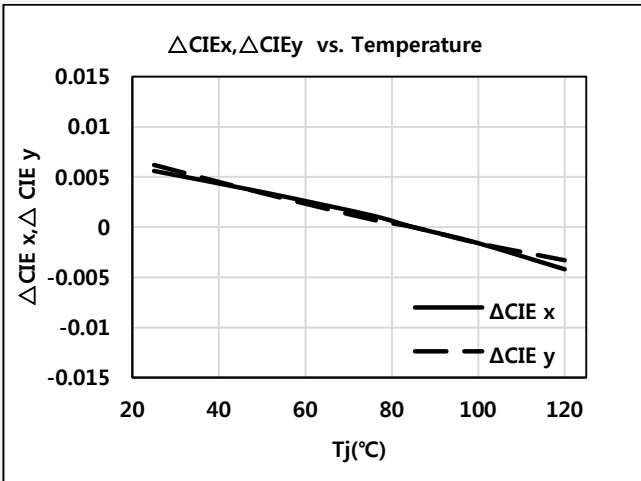

e) Derating Curve and Beam Angle Characteristics ( $I_f = 160 \text{ mA}$ ,  $T_j = 25 \text{ °C}$ )

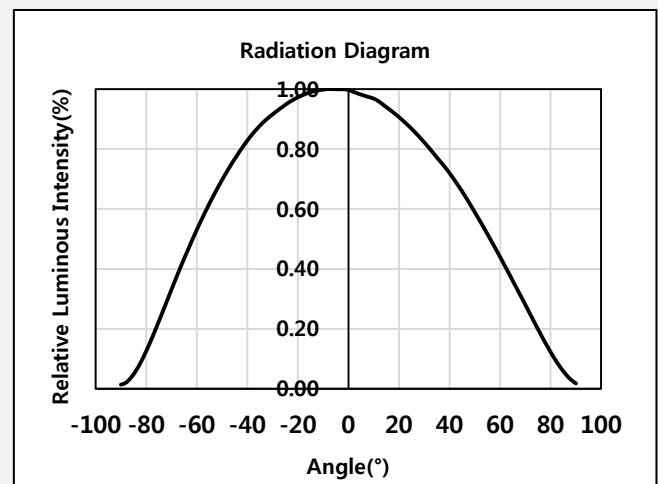
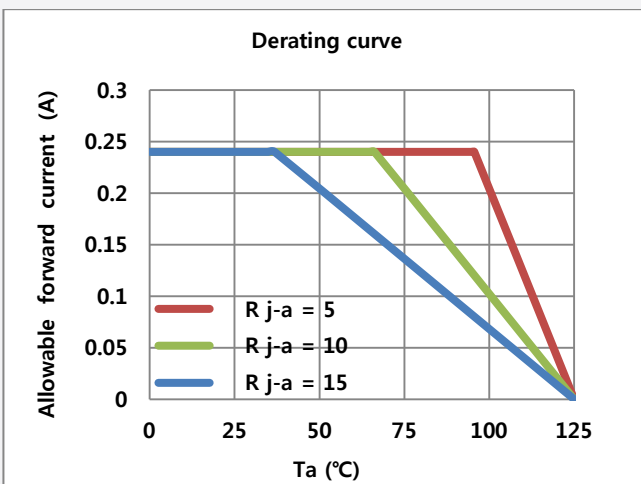

## 4. Outline Drawing & Dimension

### a) Mechanical Dimensions

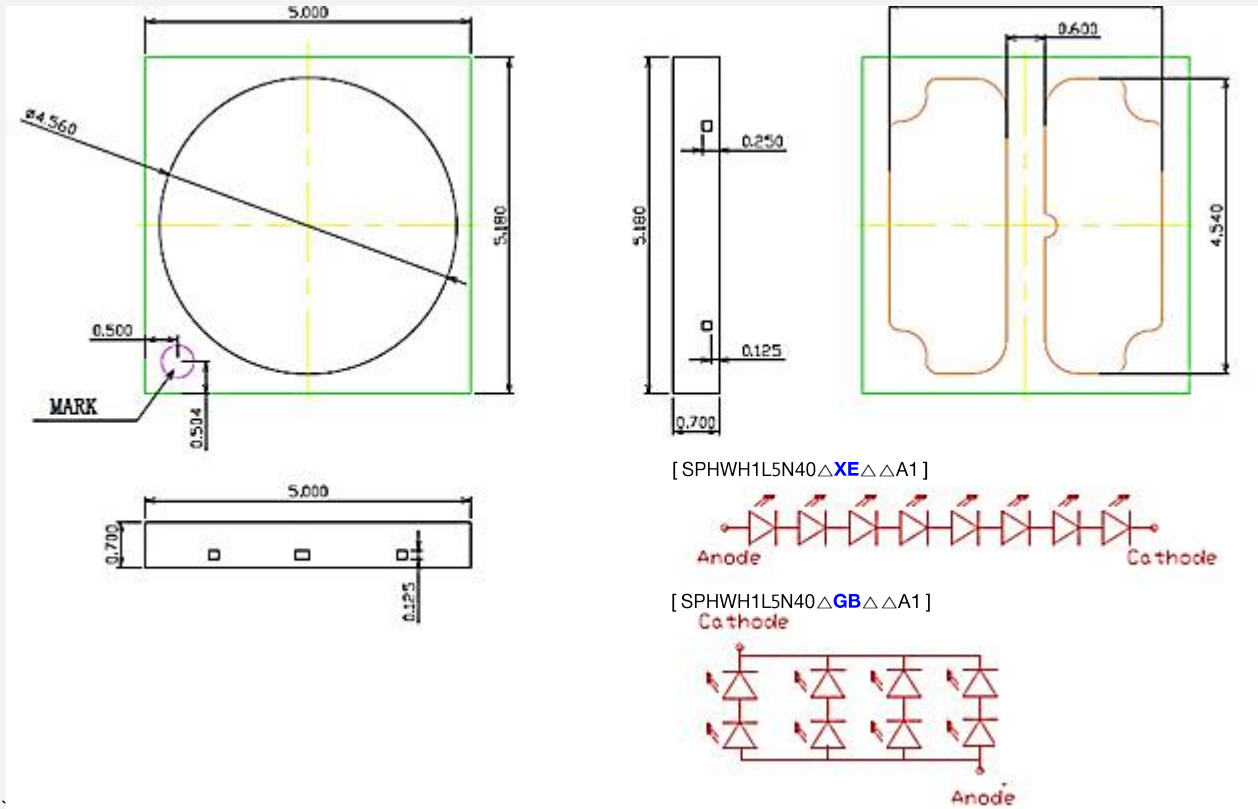

#### Notes:

- 1) Mark for the Anode

### b) Recommended Solder Pad

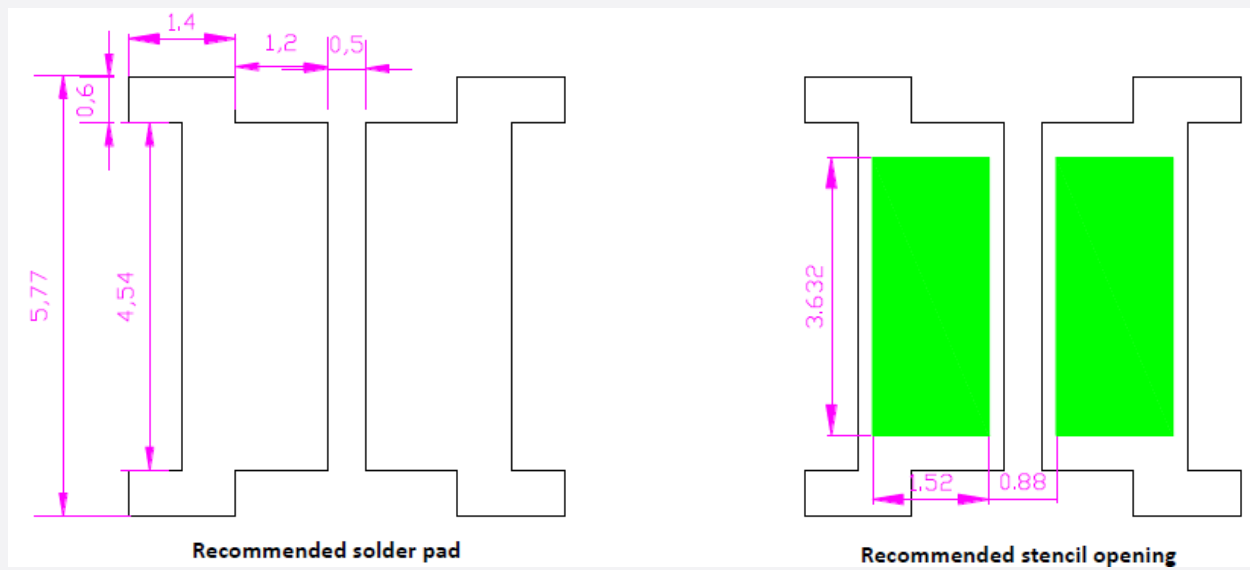

## 5. Reliability Test Items & Conditions

### a) Test Items

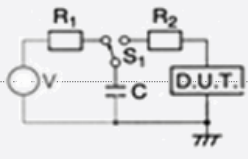
Test Item	Test Condition	Test Hour / Cycle	Sample Size
Room Temperature Life Test	25 °C, DC 240 mA	1000 h	22
High Temperature Life Test	85 °C, DC 240 mA	1000 h	22
High Temperature Humidity Life Test	85 °C, 85 % RH, DC 240 mA	1000 h	22
Low Temperature Life Test	-40 °C, DC 240 mA	1000 h	22
Powered Temperature Cycle Test	-45 °C / 20 min ↔ 85 °C / 20 min, sweep 100 min cycle on/off: each 5 min, DC 240 mA	100 cycles	22
Thermal Cycle	-45 °C / 15 min ↔ 125 °C / 15 min → Hot plate 180 °C	500 cycles	100
High Temperature Storage	120 °C	1000 h	11
Low Temperature Storage	-40 °C	1000 h	11
ESD (HBM)		5 times	30
ESD (MM)			
Vibration Test	20~2000~20 Hz, 200 m/s <sup>2</sup> , sweep 4 min X, Y, Z 3 direction, each 1 cycle	4 cycles	11
Mechanical Shock Test	1500 g, 0.5 ms 3 shocks each X-Y-Z axis	5 cycles	11

### b) Criteria for Judging the Damage

Item	Symbol	Test Condition (T <sub>s</sub> = 25 °C)	Limit	
			Min	Max
Forward Voltage	V <sub>F</sub>	I <sub>F</sub> = 160 mA	Init. Value * 0.9	Init. Value * 1.1
Luminous Flux	Φ <sub>v</sub>	I <sub>F</sub> = 160 mA	Init. Value * 0.7	Init. Value * 1.1

## 6. Soldering Conditions

### a) Reflow Conditions (Pb free)

Reflow frequency: 2 times max.

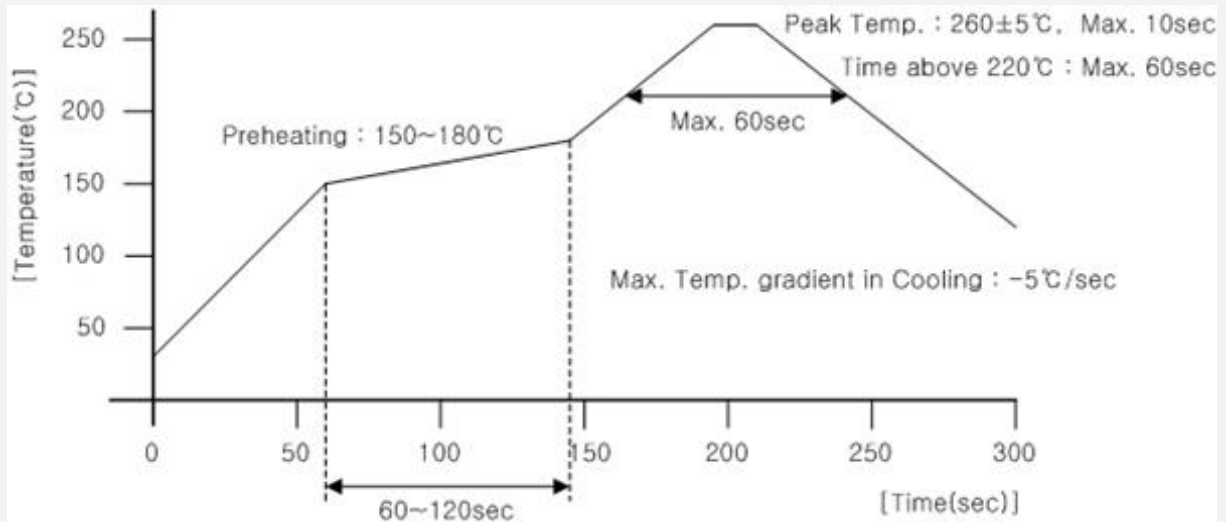

### b) Manual Soldering Conditions

Not more than 5 seconds @ max. 300 °C, under soldering iron.

## 7. Tape & Reel

### a) Taping Dimension

symbol	AO	BO	KO	PO	P1	P2	Length
Spec	5.20±0.10	5.40±0.10	0.95±0.10	4.00±0.10	8.0±0.10	2.0±0.10	1010M/R
symbol	W	T	E	F	DO	D1	
Spec	12.0±0.2	0.20±0.05	1.75±0.10	5.50±0.05	1.50+0.1/-0	1.50±0.10	

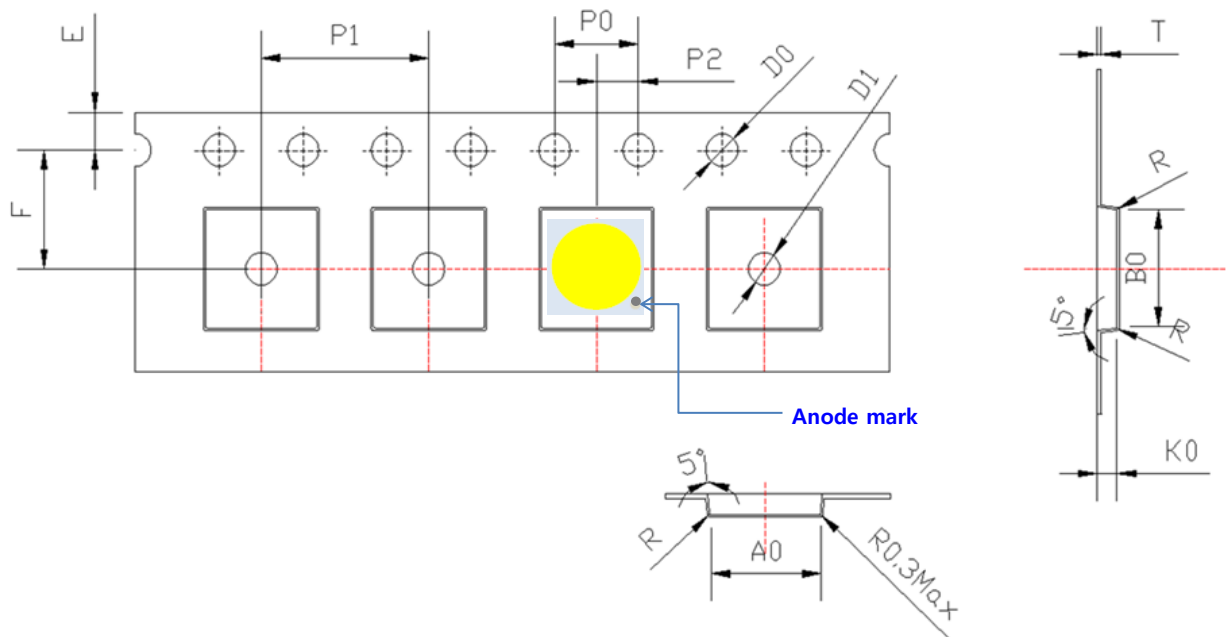

(unit: mm)

b) Reel Dimension (max 2,000 pcs)

(unit: mm)

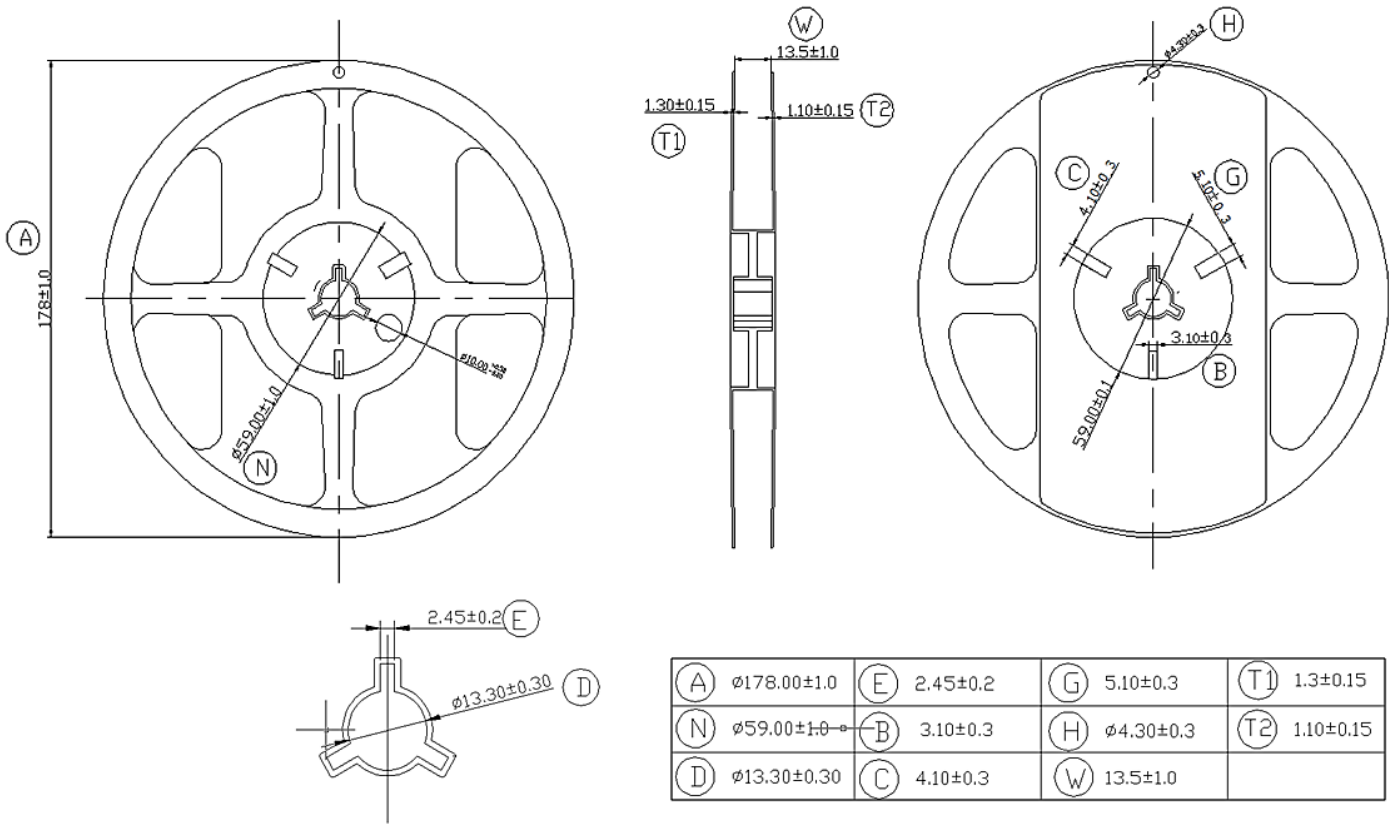

**Notes:**

- 1) Quantity: The quantity/reel is 2000 pcs
- 2) All dimensions are millimeters (tolerance :  $\pm 0.2\text{mm}$ )
- 3) Packaging: P/N, Manufacturing data code no. and quantity are indicated on the aluminum packing bag.

## 8. Label Structure

### a) Label Structure

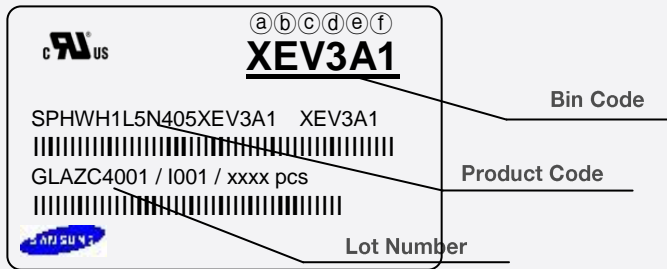

Note: Denoted bin code and product code above is only an example (see description on page 5)

Bin Code:

- ⒶⒷ: Forward Voltage bin (refer to page 7)
- ⒸⒹ: Chromaticity bin (refer to page 8)
- ⒺⒻ: Luminous Flux bin (refer to page 6)

### b) Lot Number

The lot number is composed of the following characters:

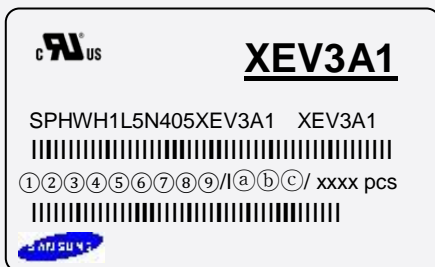

① ③④⑤⑥⑦⑧⑨ / IⒶⒷⒸ / xxxx pcs

- ①② : Production site : G8
- ③ : Product state (A: Normal, B: Bulk, C: First Production, R: Reproduction, S: Sample)
- ④ : Year (Z: 2015, A: 2016, B: 2017...)
- ⑤ : Month (1~9, A, B, C)
- ⑥ : Day (1~9, A, B~V)
- ⑦⑧⑨ : Samsung Electronics Product serial number (001 ~ 999)
- ⒶⒷⒸ : Reel number(001 ~ 999)

## 9. Packing Structure

a) Packing Process (The quantity of PKG on the Reel to be Max 2,000 pcs)

Reel

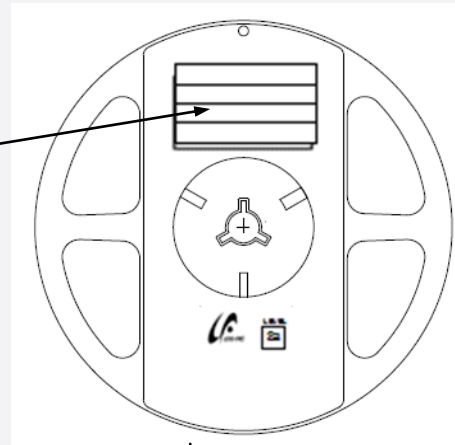
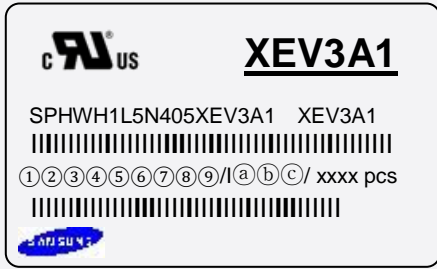

Aluminum Vinyl Packing Bag

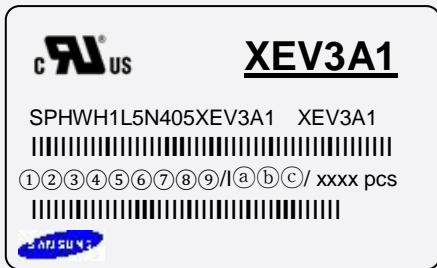

Inner Box

Material: Paper (SW3B(B))

Type	Size (mm)			Note
	L	W	H	
7 inch L	225 ± 5	65 ± 5	240 ± 5	Up to 2 reels

① Side Label

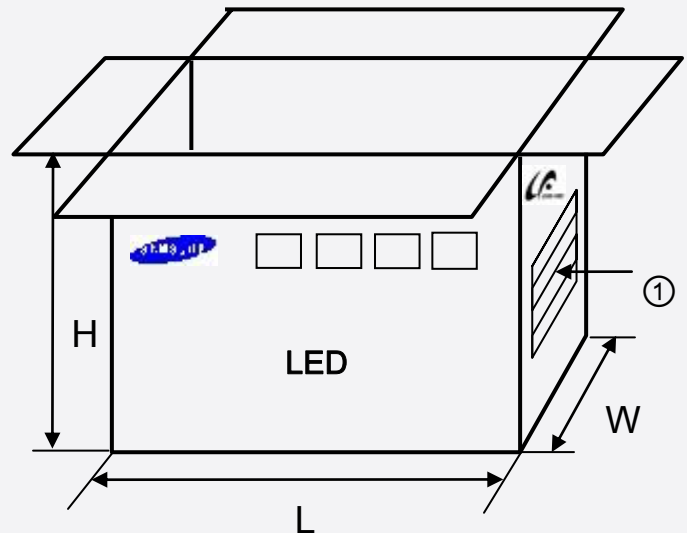
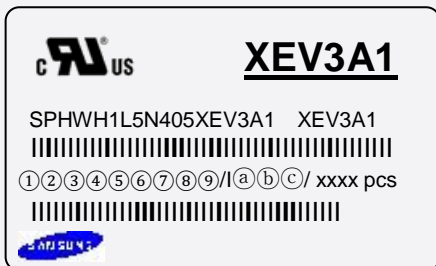

b) Packing Process (The quantity of PKG on the Reel to be Max 2,000 pcs)

Reel

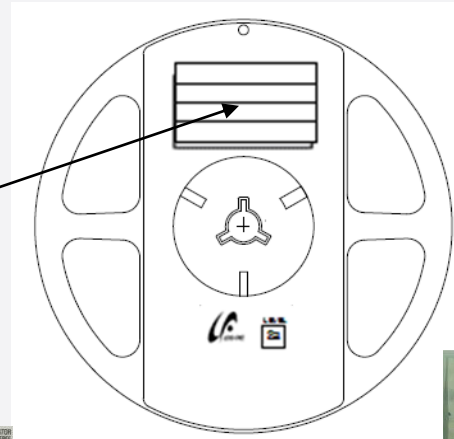
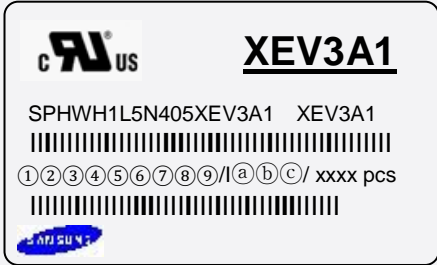

Aluminum Vinyl Packing Bag

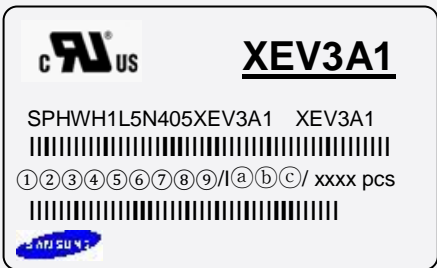

Inner Box

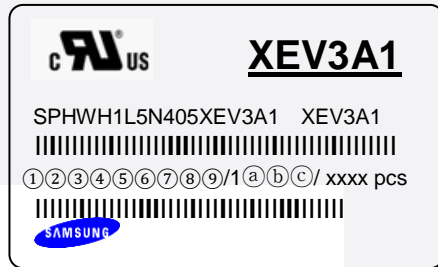

1 REEL / Aluminum Vinyl Packing Bag

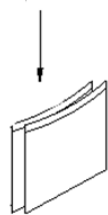

2 REEL / INNER BOX

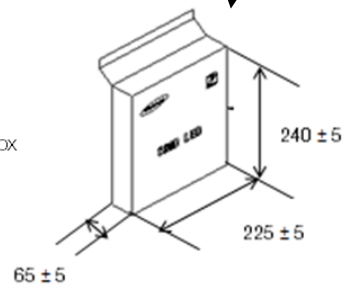



## 10. Precautions in Handling & Use

- 1) For over-current protection, users are recommended to apply resistors connected in series with the LEDs to mitigate sudden change of the forward current caused by shift of forward voltage.
- 2) This device should not be used in any type of fluid such as water, oil, organic solvent, etc. When cleaning is required, IPA is recommended as the cleaning agent. Some solvent-based cleaning agent may damage the silicone resins used in the device.
- 3) When the device is in operation, the forward current should be carefully determined considering the maximum ambient temperature and corresponding junction temperature.
- 4) LEDs must be stored in a clean environment. If the LEDs are to be stored for three months or more after being shipped from Samsung, they should be packed with a nitrogen-filled container (shelf life of sealed bags is 12 months at temperature 0~40 °C, 0~90 % RH).
- 5) After storage bag is opened, device subjected to soldering, solder reflow, or other high temperature processes must be:
  - a. Mounted within 672 hours (28 days) at an assembly line with a condition of no more than 30 °C / 60 % RH, or
  - b. Stored at <10 % RH
- 6) Repack unused devices with anti-moisture packing, fold to close any opening and then store in a dry place.
- 7) Devices require baking before mounting, if humidity card reading is >60 % at 23 ± 5 °C.
- 8) Devices must be baked for 1 hour at 60 ± 5 °C, if baking is required.
- 9) The LEDs are sensitive to the static electricity and surge current. It is recommended to use a wrist band or anti-electrostatic glove when handling the LEDs. If voltage exceeding the absolute maximum rating is applied to LEDs, it may cause damage or even destruction to LED devices. Damaged LEDs may show some unusual characteristics such as increase in leakage current, lowered turn-on voltage, or abnormal lighting of LEDs at low current.
- 10) VOCs (Volatile Organic Compounds) can be generated from adhesives, flux, hardener or organic additives used in luminaires (fixtures). Transparent LED silicone encapsulant is permeable to those chemicals and they may lead to a discoloration of encapsulant when they exposed to heat or light. This phenomenon can cause a significant loss of light emitted (output) from the luminaires. In order to prevent these problems, we recommend users to know the physical properties of materials used in luminaires and they must be carefully selected.
- 11) Risk of sulfurization (or tarnishing)  
 The LED from Samsung Electronics Co., Ltd. uses a silver-plated lead frame and its surface color may change to black (or dark colored) when it is exposed to sulfur (S), chlorine (Cl) or other halogen compound. Sulfurization of lead frame may cause intensity degradation, change of chromaticity coordinates and, in extreme cases, open circuit. It requires caution. Due to possible sulfurization of lead frame, LED should not be used and stored together with oxidizing substances made of materials such as: rubber, plain paper, lead solder cream, etc.

# Legal and additional information.

## [About Samsung Electronics Co., Ltd.](#)

Samsung Electronics Co., Ltd. inspires the world and shapes the future with transformative ideas and technologies, redefining the worlds of TVs, smartphones, wearable devices, tablets, cameras, digital appliances, printers, medical equipment, network systems and semiconductors.

We are also leading in the Internet of Things space through, among others, our Digital Health and Smart Home initiatives. We employ 307,000 people across 84 countries. To discover more, please visit our official website at [www.samsung.com](http://www.samsung.com) and our official blog at [global.samsungtomorrow.com](http://global.samsungtomorrow.com).

Copyright © 2016 Samsung Electronics Co., Ltd. All rights reserved.

Samsung is a registered trademark of Samsung Electronics Co., Ltd.

Specifications and designs are subject to change without notice. Non-metric weights and measurements are approximate. All data were deemed correct at time of creation. Samsung is not liable for errors or omissions. All brand, product, service names and logos are trademarks and/or registered trademarks of their respective owners and are hereby recognized and acknowledged.

Samsung Electronics Co., Ltd.

1, Samsung ro

Giheung-gu

Yongin-si, Gyeonggi-do, 17113

KOREA

[www.samsungled.com](http://www.samsungled.com)



## Looking for pricing, stock, or lifecycle information?

Click below to explore more details on WIN SOURCE:

- ⊖ [View SPHWH1L5N403XEV5A1 on WIN SOURCE](#)
- ⊖ [Samsung Information](#)

## Optimize Your Supply Chain with WIN SOURCE Solutions

- ✓ Global Sourcing Solution
- ✓ Obsolete Management
- ✓ Cost Control Management
- ✓ Shortage Management
- ✓ Alternative Solution
- ✓ Excess Inventory Management