



**THE DATASHEET OF  
SPHWH1L5N605XEP5A1**



High Power LED Series

# LH508A+



High efficacy and lumen makes

the LH508A+ suitable for Streetlight and High-bay applications

#### Features & Benefits

- Operates at a maximum current of up to 220mA
- Uniform light distribution under any beam angle
- Color binning @ 85 °C



**SAMSUNG**

## Table of Contents

1.	Characteristics	-----	3
2.	Product Code Information	-----	5
3.	Typical Characteristics Graphs	-----	9
4.	Outline Drawing & Dimension	-----	11
5.	Reliability Test Items & Conditions	-----	12
6.	Soldering Conditions	-----	13
7.	Tape & Reel	-----	14
8.	Label Structure	-----	16
9.	Packing Structure	-----	17
10.	Precautions in Handling & Use	-----	19

## 1. Characteristics

### a) Absolute Maximum Rating

Item	Symbol	Rating	Unit	Condition
Operating Temperature	$T_{opr}$	-40 ~ +85	°C	
Storage Temperature	$T_{stg}$	-40 ~ +100	°C	-
LED Junction Temperature	$T_j$	125	°C	-
Forward Current	$I_F$	220	mA	-
Peak Pulse Forward Current	$I_{FP}$	300	mA	Duty cycle ≤ 1/10, pulse width 10ms
Soldering Temperature		260 <10	°C s	-

### b) Electro-optical Characteristics ( $I_F = 160$ mA, $T_j = 25$ °C )

Item	Unit	Rank	Min.	Typ.	Max.
Forward Voltage ( $V_F$ )	V	XE	23.5	24.5	26.5
Color Rendering Index ( $R_a$ )	-	3	70	-	-
		5	80		
		7	90		
Thermal Resistance (junction to chip point)	°C/W		-	3	-
Beam Angle	°		-	120	-
Nominal Power	W			3.9	
ESD (HBM)	kV			±4	

#### Notes:

1) Samsung maintains measurement tolerance of: luminous flux = ±7 %, forward voltage = ±0.1 V

### c) Luminous Flux Characteristics ( $I_F = 160 \text{ mA}$ )

CRI ( $R_a$ ) Min.	Nominal CCT (K)	Flux Rank	Flux @ $T_J = 25 \text{ }^\circ\text{C}$ (lm)		
			Min.	Typ.	Max.
70	2700K	A1	580	600	-
	3000K	A1	580	620	-
	4000K	A1	620	650	-
	5000K	A1	620	650	-
	5700k	A1	620	650	-
	6500k	A1	620	620	-
80	2700K	A1	540	560	-
	3000K	A1	540	585	-
	3500K	A1	540	595	-
	4000K	A1	580	610	-
	5000K	A1	580	610	-
	5700k	A1	580	610	-
90	6500k	A1	580	610	-
	2700K	A1	420	471	-
	3000K	A1	428	486	-
	3500K	A1	445	506	-
	4000K	A1	460	526	-
	5000K	A1	460	526	-
	5700k	A1	460	526	-

### d) Luminous Flux Characteristics ( $T_J = 25^\circ\text{C}$ )

Flux Rank	Sorting @ 640mA (lm)			Input Current			
	Flux Range <sup>1)</sup>	Sub Bin	@60mA	@100mA	@160mA	@200mA	@220mA
A1	420 – 460	42	171.0	275.6	420.0	509.8	551.9
	460 – 500	46	187.2	301.8	460.0	558.3	604.5
	500 - 540	50	203.5	328.1	500.0	606.9	657.0
	540 ~ 580	54	219.8	354.3	540.0	655.4	709.6
	580 ~ 620	58	236.1	380.5	580.0	704.0	762.1
	620 ~ 660	62	252.4	406.8	620.0	752.5	814.7
	660 ~ 700	66	268.6	433.0	660.0	801.0	867.2

#### Notes:

- 1) Tested in pulsed operating condition at rated test current (10 ms pulse width) and rated temperature
- 2) Samsung maintains measurement tolerance of: Luminous flux =  $\pm 7\%$ , CRI =  $\pm 1$

## 2. Product Code Information

1	2	3	4	5	6	7	8	9	10	11	12	13	14	15	16	17	18
S	P	H	W	H	1	L	5	N	6	0	5	X	E	Q	5	A	1

Digit	PKG Information	Code	Specification								
1 2 3	Samsung Package High Power	SPH									
4 5	Color	WH	White								
6	Product Version	1	1								
7 8	Form Factor	L5	5050 size								
9	Lens Type	N	No lens								
10	Model	6	LH508A+								
11	Internal Code	0									
12	CRI	3	Min. 70 (25°C)								
		5	Min. 80 (25°C)								
		7	Min. 90 (25°C)								
13 14	Forward Voltage (V)	XE	<b>Bin Code</b>	<b>D1</b>	<b>E1</b>	<b>F1</b>					
			Vf(V)	23.5 ~ 24.5	24.5 ~ 25.5	25.5 ~ 26.5					
15	CCT (K)	W	2700k								
		V	3000k								
		U	3500k								
		T	4000k								
		R	5000k								
		Q	5700k								
		p	6500k								
16	MacAdam Step	3	MacAdam 3-Step								
		5	MacAdam 5-Step								
17 18	Luminous Flux (lm)	A1	<b>Model</b>	<b>Bin Code</b>	<b>42</b>	<b>46</b>	<b>50</b>	<b>54</b>	<b>58</b>	<b>62</b>	<b>66</b>
			<b>Flux(lm)</b>	<b>420-460</b>	<b>460-500</b>	<b>500-540</b>	<b>540-580</b>	<b>580-620</b>	<b>620-660</b>	<b>660-700</b>	
			CRI 70	2700K					SPHWH1L5N603XEW★A1		
				3000K					SPHWH1L5N603XEV★A1		
				4000K						SPHWH1L5N603XET★A1	
				5000K						SPHWH1L5N603XER★A1	
				5700K						SPHWH1L5N603XEQ★A1	
				6500K						SPHWH1L5N603XEP★A1	
			CRI 80	2700K				SPHWH1L5N605XEW★A1			
				3000K				SPHWH1L5N605XEV★A1			
				3500K				SPHWH1L5N605XEU★A1			
				4000K					SPHWH1L5N605XET★A1		
				5000K					SPHWH1L5N605XER★A1		
				5700K					SPHWH1L5N605XEQ★A1		
			CRI 90	2700K		SPHWH1L5N607XEW★A1					
				3000K		SPHWH1L5N607XEV★A1					
				3500K		SPHWH1L5N607XEU★A1					
				4000K			SPHWH1L5N607XET★A1				
				5000K			SPHWH1L5N607XER★A1				
				5700K			SPHWH1L5N607XEQ★A1				

★ can be replaced with '5' for the MAC5 color binning, or '3' for the MAC3 color binning

a) Luminous flux Rank ( $I_F = 160 \text{ mA}$ )

CRI (R <sub>a</sub> ) Min.	Nominal CCT (K)	Product Code	V <sub>F</sub> Rank (T <sub>J</sub> =25°C)	Chrom. Rank (bins) (T <sub>J</sub> =25°C)	Flux		Flux Range (Φ <sub>v</sub> , lm) (T <sub>J</sub> =25°C)
					Rank	Bins	
70	2700	SPHWH1L5N603XEW3A1	XE	W3, W5	A1	58	580 – 620
		SPHWH1L5N603XEW5A1				62	620 – 660
	3000	SPHWH1L5N603XEV3A1	XE	V3, V5	A1	58	580 – 620
		SPHWH1L5N603XEV5A1				62	620 – 660
	4000	SPHWH1L5N603XET3A1	XE	T3, T5	A1	62	620 – 660
		SPHWH1L5N603XET5A1				66	660 – 700
	5000	SPHWH1L5N603XER3A1	XE	R3, R5	A1	58	580 – 620
		SPHWH1L5N603XER5A1				66	660 – 700
	5700	SPHWH1L5N603XEQ3A1	XE	Q3, Q5	A1	58	580 – 620
		SPHWH1L5N603XEQ5A1				66	660 – 700
	6500	SPHWH1L5N603XEP3A1	XE	P3, P5	A1	58	580 – 620
		SPHWH1L5N603XEP5A1				66	660 – 700
80	2700K	SPHWH1L5N605XEW3A1	XE	W3, W5	A1	54	540 – 580
		SPHWH1L5N605XEW5A1				58	580 – 620
	3000K	SPHWH1L5N605XEV3A1	XE	V3, V5	A1	54	540 – 580
		SPHWH1L5N605XEV5A1				58	580 – 620
	3500K	SPHWH1L5N605XEU3A1	XE	U3, U5	A1	54	540 – 580
		SPHWH1L5N605XEU5A1				58	580 – 620
	4000K	SPHWH1L5N605XET3A1	XE	T3, T5	A1	58	580 – 620
		SPHWH1L5N605XET5A1				62	620 – 660
	5000K	SPHWH1L5N605XER3A1	XE	R3, R5	A1	58	580 – 620
		SPHWH1L5N605XER5A1				62	620 – 660
	5700K	SPHWH1L5N605XEQ3A1	XE	Q3, Q5	A1	58	580 – 620
		SPHWH1L5N605XEQ5A1				62	620 – 660
6500K	SPHWH1L5N605XEP3A1	XE	P3, P5	A1	58	580 – 620	
	SPHWH1L5N605XEP5A1				62	620 – 660	
90	2700K	SPHWH1L5N607XEW3A1 SPHWH1L5N607XEW5A1	XE	W3, W5	A1	42	420 – 460
						46	460 – 500
						50	500 – 540
	3000K	SPHWH1L5N607XEV3A1 SPHWH1L5N607XEV5A1	XE	V3, V5	A1	42	420 – 460
						46	460 – 500
						50	500 – 540
	3500K	SPHWH1L5N607XEU3A1 SPHWH1L5N607XEU5A1	XE	U3, U5	A1	42	420 – 460
						46	460 – 500
						50	500 – 540
	4000K	SPHWH1L5N607XET3A1 SPHWH1L5N607XET5A1	XE	T3, T5	A1	46	460 – 500
						50	500 – 540
						54	540 – 580

5000K	SPHWH1L5N607XER3A1 SPHWH1L5N607XER5A1	XE	R3, R5	A1	46	460 ~ 500
					50	500 ~ 540
					54	540 ~ 580
5700K	SPHWH1L5N607XEQ3A1 SPHWH1L5N607XEQ5A1	XE	Q3, Q5	A1	46	460 ~ 500
					50	500 ~ 540
					54	540 ~ 580

**b) Voltage Bins (  $I_F = 160 \text{ mA}$ ,  $T_j = 25 \text{ }^\circ\text{C}$  )**

Nominal CCT (K)	CRI (R <sub>a</sub> ) Min.	Product Code	Voltage Rank	Voltage Bin	Voltage Range (V)
-	-	-	XE	D1	23.5 ~ 24.5
				E1	24.5 ~ 25.5
				F1	25.5 ~ 26.5

### c) Chromaticity Region & Coordinates ( $I_F = 160 \text{ mA}$ , $T_J = 85 \text{ }^\circ\text{C}$ )



CRI	CCT	Rank	CIE x	CIE y	$\Phi$	a	b
70 / 80 / 90	2700K	W3	0.4578	0.4101	53.7	0.0081	0.0042
		W5	0.4578	0.4101	53.7	0.0135	0.0070
	3000K	V3	0.4338	0.4030	53.2	0.0083	0.0041
		V5	0.4338	0.4030	53.2	0.0138	0.0068
	3500K	U3	0.4073	0.3917	54.0	0.0093	0.0041
		U5	0.4073	0.3917	54.0	0.0155	0.0069
	4000K	T3	0.3818	0.3797	53.7	0.0094	0.0040
		T5	0.3818	0.3797	53.7	0.0157	0.0067
	5000K	R3	0.3447	0.3553	59.6	0.0082	0.0035
		R5	0.3447	0.3553	59.6	0.0137	0.0058
	5700K	Q3	0.3287	0.3417	59.1	0.0075	0.0032
		Q5	0.3287	0.3417	59.1	0.0125	0.0053
	6500K	P3	0.3123	0.3282	58.6	0.0067	0.0029
		P5	0.3123	0.3282	58.6	0.0112	0.0048

**Note :** Samsung maintains measurement tolerance of:  $C_x, C_y = \pm 0.005$

### 3. Typical Characteristic Graphs

#### a) Spectral Distribution ( $I_f = 160 \text{ mA}$ , $T_J = 25 \text{ }^\circ\text{C}$ )



#### b) Forward Current Characteristics ( $T_J = 25 \text{ }^\circ\text{C}$ )



c) Temperature Characteristics ( $I_F = 160 \text{ mA}$ )

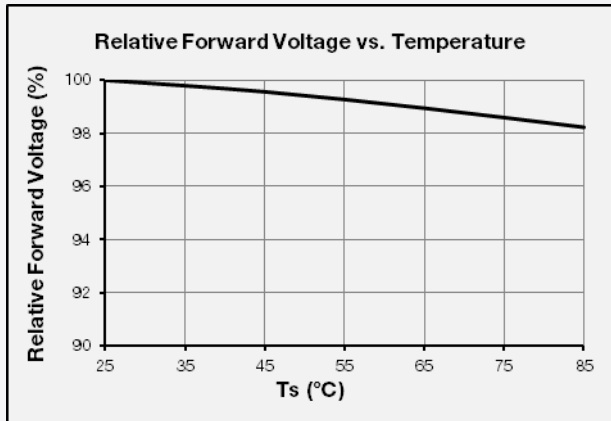

d) Color Shift Characteristics ( $I_F = 160 \text{ mA}$ ,  $T_J = 25 \text{ °C}$ )

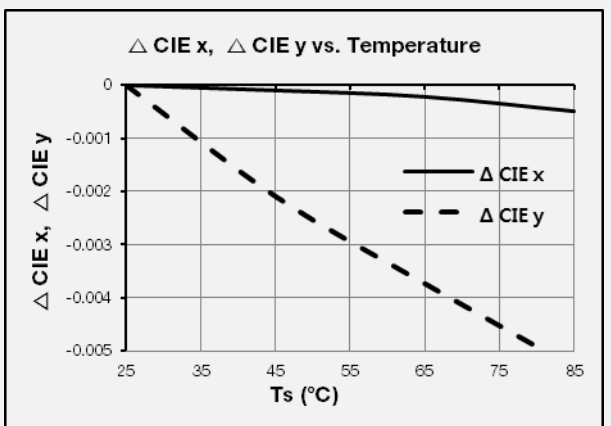

e) Beam Angle Characteristics ( $I_F = 160 \text{ mA}$ ,  $T_J = 25 \text{ °C}$ )



## 4. Outline Drawing & Dimension

### a) Mechanical Dimensions



#### Notes:

- 1) Mark for the Anode
- 2) Unit : mm
- 3) Tolerance :  $\pm 0.1\text{mm}$

### b) Recommended Solder Pad

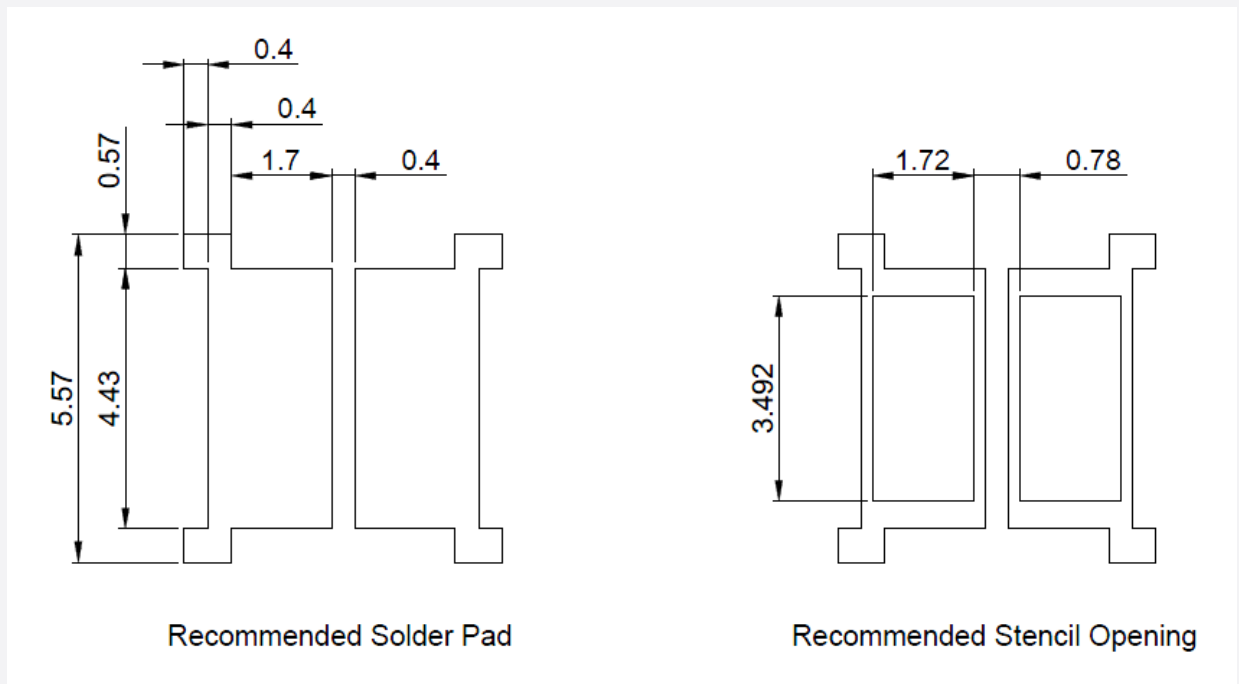

## 5. Reliability Test Items & Conditions

### a) Test Items

Test Item	Test Condition	Test Hour / Cycle
High Temperature Life Test	85 °C, Derating IF	1000 h
High Temperature Humidity Life Test	60 °C, 90 % RH, Derating IF	1000 h
Low Temperature Life Test	-40 °C, Derating IF	1000 h
Powered Temperature Cycle Test	-45 °C / 20 min ↔ 85 °C / 20 min, sweep 100 min cycle on/off: each 5 min, Derating IF	100 cycles
Thermal Cycle	-45 °C / 15 min ↔ 125 °C / 15 min temperature change within 5 min	500 cycles
High Temperature Storage	100 °C	1000 h
Low Temperature Storage	-40 °C	1000 h
ESD (HBM)	 <p> <math>R_1</math>: 10 M<math>\Omega</math>  <math>R_2</math>: 1.5 k<math>\Omega</math>  <math>C</math>: 100 pF  <math>V</math>: <math>\pm 4</math> kV         </p>	5 times
ESD (MM)	$R_1$ : 10 M $\Omega$ $R_2$ : 0 $C$ : 200 pF $V$ : $\pm 0.4$ kV	5 times
Vibration Test	20~2000~20 Hz, 200 m/s <sup>2</sup> , sweep 4 min X, Y, Z 3 direction, each 1 cycle	4 cycles
Mechanical Shock Test	1500 g, 0.5 ms 3 shocks each X-Y-Z axis	5 cycles

### b) Criteria for Judging the Damage

Item	Symbol	Test Condition ( $T_s = 25$ °C)	Limit	
			Min	Max
Forward Voltage	$V_F$	$I_F = 160$ mA	Init. Value * 0.9	Init. Value * 1.1
Luminous Flux	$\Phi_V$	$I_F = 160$ mA	Init. Value * 0.7	Init. Value * 1.1

## 6. Soldering Conditions

### a) Reflow Conditions (Pb free)

Reflow frequency: 2 times max.



### b) Manual Soldering Conditions

Not more than 5 seconds @ max. 300 °C, under soldering iron.

## 7. Tape & Reel

### a) Taping Dimension

(unit: mm)

symbol	AO	BO	KO	PO	P1	P2
Spec	5.20±0.10	5.40±0.10	0.95±0.10	4.00±0.10	8.0±0.10	2.0±0.10
symbol	W	T	E	F	DO	D1
Spec	12.0±0.2	0.20±0.05	1.75±0.10	5.50±0.05	1.50+0.1/-0	1.50±0.10

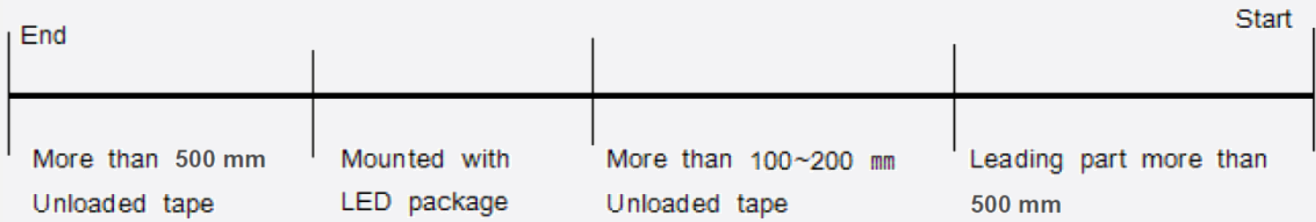
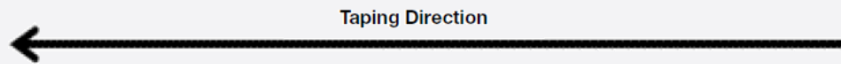

### b) Reel Dimension (max 2,000 pcs)

(unit: mm)

**Notes:**

- 1) Quantity: The quantity/reel is 2000 pcs
- 2) All dimensions are millimeters (tolerance :  $\pm 0.2\text{mm}$ )
- 3) Packaging : P/N, Manufacturing data code no. and quantity are indicated on the aluminum packing bag.

## 8. Label Structure

### a) Label Structure



Note: Denoted bin code and product code above is only an example (see description on page 5)

Bin Code:

- ⒶⒷ: Forward Voltage bin (refer to page 7)
- ⒸⒹ: Chromaticity bin (refer to page 8)
- ⒺⒻ: Luminous Flux bin (refer to page 6)

### b) Lot Number

The lot number is composed of the following characters:

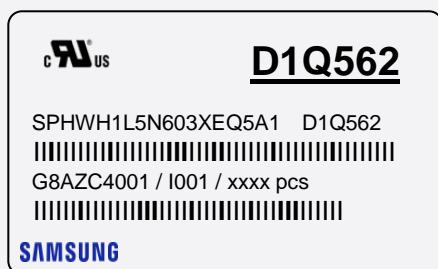

①②③④⑤⑥⑦⑧⑨ / IⒶⒷⒸ / xxxx pcs

- ①② : Production site (G8: Xiamen, China)
- ③ : Product state (A: Normal, B: Bulk, C: First Production, R: Reproduction, S: Sample)
- ④ : Year (B: 2017, C:2018, D:2019...)
- ⑤ : Month (1~9, A, B, C)
- ⑥ : Day (1~9, A, B~V)
- ⑦⑧⑨ : Samsung Electronics Product serial number (001 ~ 999)
- ⒶⒷⒸ : Reel number(001 ~ 999)

### 9. Packing Structure

#### a) Packing Process

Reel

**c AU US** **D1Q562**

SPHWH1L5N603XEQ5A1 D1Q562

|||||

G8AZC4001 / I001 / xxxx pcs

|||||

**SAMSUNG**

Reel



Aluminum Vinyl Packing Bag

**c AU US** **D1Q562**

SPHWH1L5N603XEQ5A1 D1Q562

|||||

G8AZC4001 / I001 / xxxx pcs

|||||

**SAMSUNG**

Aluminum Vinyl Packing Bag



Contains up to 2 bags

Inner Box

**c AU US** **D1Q562**

SPHWH1L5N603XEQ5A1 D1Q562

|||||

G8AZC4001 / I001 / xxxx pcs

|||||

**SAMSUNG**

Inner box

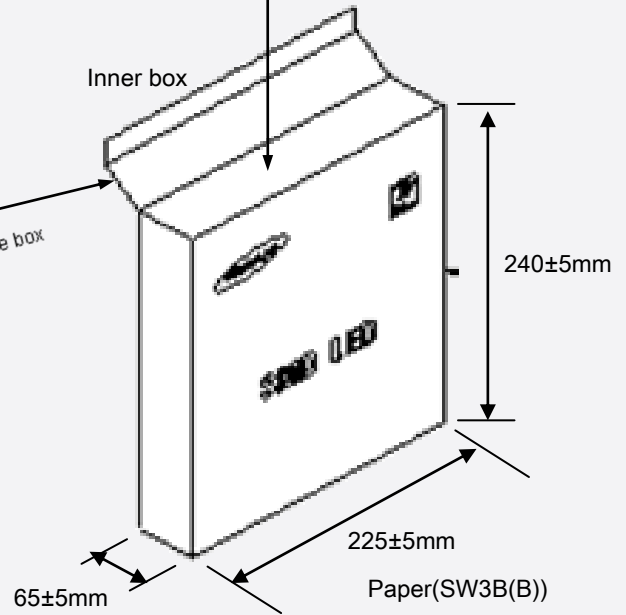

b) Aluminum Vinyl Packing Bag



**CAUTION**

This bag contains  
**MOISTURE SENSITIVE DEVICES**

**LEVEL**

2a



**D1Q562**

SPHWH1L5N603XEQ5A1 D1Q562  
 |||  
 G8AZC4001 / I001 / xxxx pcs  
 |||

**SAMSUNG**

1. Shelf life in sealed bag: 12 months at <math>40^{\circ}\text{C}</math> and <math>90\%</math> relative humidity (RH)

2. Peak package body temperature: <math>240^{\circ}\text{C}</math>

3. After this bag is opened, devices that will be subjected to reflow solder or other high temperature processes must be:

- a. Mounted within 672 hours at factory conditions of equal to or less than <math>30^{\circ}\text{C}</math> / <math>60\%</math> RH, or
- b. Stored at <math>10\%</math> RH

4. Devices require bake, before mounting, if:

- a. Humidity Indicator Card is ><math>60\%</math> when read at <math>23\pm 5^{\circ}\text{C}</math>, or
- b. 2a is not met.

5. If baking is required, devices must be baked for 10 ~ 24 hours at <math>60\pm 5^{\circ}\text{C}</math>

Note: If device containers cannot be subjected to high temperature or shorter bake times are desired, reference IPC/JEDEC J-STD-033 for bake procedure.

Bag seal due date: \_\_\_\_\_  
 (if blank, see code label)

Note: Level and body temperature by IPC/JEDEC J-STD-020





**ATTENTION**  
OBSERVE PRECAUTIONS FOR HANDLING ELECTROSTATIC SENSITIVE DEVICES



**■ 주의 사항**

이 알루미늄 지퍼 백은 습기 및 정전기로부터 제품을 보호하기 위하여 제작되었습니다. 개봉 후에는 즉시 솔더 작업을 실시하는 것을 권장합니다.

습기 및 정전기로부터 제품을 보호 하기 위해서 개봉 후 사용하지 않는 자재는 본 팩에 넣어 보관 하시기 바랍니다. 사용하지 않는 자재를 본 팩에 넣을 때는 반드시 동봉된 드라이 팩과 함께 넣고 지퍼부분을 완전하게 밀봉하여 주시기 바랍니다.

**■ Important**

This Al Zipper bag is designed to protect the enclosed products from moisture and ESD. Once opened, the products should be soldered onto the printed circuit board immediately. When not in use, please do not leave the products unprotected by the Al Zipper Bag. To repack unused products., please ensure the zip-lock is completely sealed with the dry pack left inside.

c) Humidity Indicator Card inside Aluminum Vinyl Bag



## 10. Precautions in Handling & Use

- 1) For over-current protection, users are recommended to apply resistors connected in series with the LEDs to mitigate sudden change of the forward current caused by shift of forward voltage.
- 2) This device should not be used in any type of fluid such as water, oil, organic solvent, etc. When cleaning is required, IPA is recommended as the cleaning agent. Some solvent-based cleaning agent may damage the silicone resins used in the device.
- 3) When the device is in operation, the forward current should be carefully determined considering the maximum ambient temperature and corresponding junction temperature.
- 4) LEDs must be stored in a clean environment. If the LEDs are to be stored for three months or more after being shipped from Samsung, they should be packed with a nitrogen-filled container (shelf life of sealed bags is 12 months at temperature 0~40 °C, 0~90 % RH).
- 5) After storage bag is opened, device subjected to soldering, solder reflow, or other high temperature processes must be:
  - a. Mounted within 672 hours (28 days) at an assembly line with a condition of no more than 30 °C / 60 % RH, or
  - b. Stored at <10 % RH
- 6) Repack unused devices with anti-moisture packing, fold to close any opening and then store in a dry place.
- 7) Devices require baking before mounting, if humidity card reading is >60 % at 23 ± 5 °C.
- 8) Devices must be baked for 1 hour at 60 ± 5 °C, if baking is required.
- 9) The LEDs are sensitive to the static electricity and surge current. It is recommended to use a wrist band or anti-electrostatic glove when handling the LEDs. If voltage exceeding the absolute maximum rating is applied to LEDs, it may cause damage or even destruction to LED devices. Damaged LEDs may show some unusual characteristics such as increase in leakage current, lowered turn-on voltage, or abnormal lighting of LEDs at low current.
- 10) VOCs (Volatile Organic Compounds) can be generated from adhesives, flux, hardener or organic additives used in luminaires (fixtures). Transparent LED silicone encapsulant is permeable to those chemicals and they may lead to a discoloration of encapsulant when they exposed to heat or light. This phenomenon can cause a significant loss of light emitted (output) from the luminaires. In order to prevent these problems, we recommend users to know the physical properties of materials used in luminaires and they must be carefully selected.
- 11) Risk of sulfurization (or tarnishing)  
 The LED from Samsung Electronics Co., Ltd. uses a silver-plated lead frame and its surface color may change to black (or dark colored) when it is exposed to sulfur (S), chlorine (Cl) or other halogen compound. Sulfurization of lead frame may cause intensity degradation, change of chromaticity coordinates and, in extreme cases, open circuit. It requires caution. Due to possible sulfurization of lead frame, LED should not be used and stored together with oxidizing substances made of materials such as: rubber, plain paper, lead solder cream, etc.

# Legal and additional information.

## [About Samsung Electronics Co., Ltd.](#)

Samsung Electronics Co., Ltd. inspires the world and shapes the future with transformative ideas and technologies, redefining the worlds of TVs, smartphones, wearable devices, tablets, cameras, digital appliances, printers, medical equipment, network systems and semiconductors.

We are also leading in the Internet of Things space through, among others, our Digital Health and Smart Home initiatives. We employ 307,000 people across 84 countries. To discover more, please visit our official website at [www.samsung.com](http://www.samsung.com) and our official blog at [global.samsungtomorrow.com](http://global.samsungtomorrow.com).

Copyright © 2018 Samsung Electronics Co., Ltd. All rights reserved.

Samsung is a registered trademark of Samsung Electronics Co., Ltd.

Specifications and designs are subject to change without notice. Non-metric weights and measurements are approximate. All data were deemed correct at time of creation. Samsung is not liable for errors or omissions. All brand, product, service names and logos are trademarks and/or registered trademarks of their respective owners and are hereby recognized and acknowledged.

Samsung Electronics Co., Ltd.

1, Samsung ro

Giheung-gu

**SAMSUNG**

## Looking for pricing, stock, or lifecycle information?

Click below to explore more details on WIN SOURCE:

- ⊖ [View SPHWH1L5N605XEP5A1 on WIN SOURCE](#)
- ⊖ [Samsung Information](#)

## Optimize Your Supply Chain with WIN SOURCE Solutions

- ✓ Global Sourcing Solution
- ✓ Obsolete Management
- ✓ Cost Control Management
- ✓ Shortage Management
- ✓ Alternative Solution
- ✓ Excess Inventory Management