



**THE DATASHEET OF
SPHWH1L5N605YEV5A1**



High Power LED Series

LH508A+



High efficacy and lumen makes

the LH508A+ suitable for Streetlight and High-bay applications

Features & Benefits

- Operates at a maximum current of up to 880mA
- Uniform light distribution under any beam angle
- Color binning @ 85 °C



Table of Contents

1.	Characteristics	-----	3
2.	Product Code Information	-----	5
3.	Typical Characteristics Graphs	-----	9
4.	Outline Drawing & Dimension	-----	11
5.	Reliability Test Items & Conditions	-----	12
6.	Soldering Conditions	-----	13
7.	Tape & Reel	-----	14
8.	Label Structure	-----	16
9.	Packing Structure	-----	17
10.	Precautions in Handling & Use	-----	19

1. Characteristics

a) Absolute Maximum Rating

Item	Symbol	Rating	Unit	Condition
Operating Temperature	T_{opr}	-40 ~ +85	°C	
Storage Temperature	T_{stg}	-40 ~ +100	°C	-
LED Junction Temperature	T_j	125	°C	-
Forward Current	I_F	880	mA	-
Peak Pulse Forward Current	I_{FP}	1000	mA	Duty cycle ≤ 1/10, pulse width 10ms
Soldering Temperature		260 <10	°C s	-

b) Electro-optical Characteristics ($I_F = 640$ mA, $T_j = 25$ °C)

Item	Unit	Rank	Min.	Typ.	Max.
Forward Voltage (V_F)	V	YE	5.8	6.1	6.4
Color Rendering Index (R_a)	-	3	70	-	-
		5	80		
		7	90		
Thermal Resistance (junction to chip point)	°C/W		-	3	-
Beam Angle	°		-	120	-
Nominal Power	W			3.9	
ESD (HBM)	kV			±4	

Notes:

1) Samsung maintains measurement tolerance of: luminous flux = ±7 %, forward voltage = ±0.1 V

c) Luminous Flux Characteristics (I_F = 640 mA)

CRI (R _a) Min.	Nominal CCT (K)	Flux Rank	Flux @ T _J = 25 °C (lm)		
			Min.	Typ.	Max.
70	2700K	A1	580	600	-
	3000K	A1	580	620	-
	4000K	A1	620	650	-
	5000K	A1	620	650	-
	5700k	A1	620	650	-
	6500k	A1	620	650	-
80	2700K	A1	540	560	
	3000K	A1	540	585	
	3500K	A1	540	595	
	4000K	A1	580	610	
	5000K	A1	580	610	
	5700k	A1	580	610	
90	2700K	A1	420	471	
	3000K	A1	428	486	
	3500K	A1	445	506	
	4000K	A1	460	526	
	5000K	A1	460	526	
	5700k	A1	460	526	

d) Luminous Flux Characteristics (T_J = 25°C)

Flux Rank	Sorting @ 640mA (lm)		Input Current				
	Flux Range ¹⁾	Sub Bin	@240mA	@400mA	@640mA	@800mA	@880mA
A1	420 – 460	42	171.0	275.6	420.0	509.8	551.9
	460 – 500	46	187.2	301.8	460.0	558.3	604.5
	500 - 540	50	203.5	328.1	500.0	606.9	657.0
	540 ~ 580	54	219.8	354.3	540.0	655.4	709.6
	580 ~ 620	58	236.1	380.5	580.0	704.0	762.1
	620 ~ 660	62	252.4	406.8	620.0	752.5	814.7
	660 ~ 700	66	268.6	433.0	660.0	801.0	867.2

Notes:

- 1) Tested in pulsed operating condition at rated test current (10 ms pulse width) and rated temperature
- 2) Samsung maintains measurement tolerance of: Luminous flux = ±7 %, CRI = ±1

2. Product Code Information

1	2	3	4	5	6	7	8	9	10	11	12	13	14	15	16	17	18
S	P	H	W	H	1	L	5	N	6	0	5	Y	E	Q	5	A	1

Digit	PKG Information	Code	Specification								
1 2 3	Samsung Package High Power	SPH									
4 5	Color	WH	White								
6	Product Version	1	1								
7 8	Form Factor	L5	5050 size								
9	Lens Type	N	No lens								
10	Model	6	LH508A+								
11	Internal Code	0									
12	CRI	3	Min. 70 (25°C)								
		5	Min. 80 (25°C)								
		7	Min. 90 (25°C)								
13 14	Forward Voltage (V)	YE	Bin Code	A0	A1	A2					
			Vf(V)	5.8 ~ 6.0	6.0 ~ 6.2	6.2 ~ 6.4					
15	CCT (K)	W	2700k								
		V	3000k								
		U	3500k								
		T	4000k								
		R	5000k								
		Q	5700k								
		p	6500k								
16	MacAdam Step	3	MacAdam 3-Step								
		5	MacAdam 5-Step								
17 18	Luminous Flux (lm)	A1	Model	Bin Code	42	46	50	54	58	62	66
			Flux(lm)	420-460	460-500	500-540	540-580	580-620	620-660	660-700	
			CRI 70	2700K					SPHWH1L5N603YEW★A1		
				3000K					SPHWH1L5N603YEV★A1		
				4000K						SPHWH1L5N603YET★A1	
				5000K						SPHWH1L5N603YER★A1	
				5700K						SPHWH1L5N603YEQ★A1	
				6500K						SPHWH1L5N603YEP★A1	
			CRI 80	2700K				SPHWH1L5N605YEW★A1			
				3000K				SPHWH1L5N605YEV★A1			
				3500K				SPHWH1L5N605YEU★A1			
				4000K					SPHWH1L5N605YET★A1		
				5000K					SPHWH1L5N605YER★A1		
				5700K					SPHWH1L5N605YEQ★A1		
			CRI 90	2700K				SPHWH1L5N607YEW★A1			
				3000K				SPHWH1L5N607YEV★A1			
				3500K				SPHWH1L5N607YEU★A1			
				4000K					SPHWH1L5N607YET★A1		
				5000K					SPHWH1L5N607YER★A1		
				5700K					SPHWH1L5N607YEQ★A1		

★ can be replaced with '5' for the MAC5 color binning, or '3' for the MAC3 color binning

a) Luminous flux Rank ($I_F = 640 \text{ mA}$)

CRI (R _a) Min.	Nominal CCT (K)	Product Code	V _F Rank (T _J =25°C)	Chrom. Rank (bins) (T _J =25°C)	Flux		Flux Range (Φ _v , lm) (T _J =25°C)
					Rank	Bins	
70	2700	SPHWH1L5N603YEW3A1	YE	W3, W5	A1	58	580 – 620
		SPHWH1L5N603YEW5A1				62	620 – 660
	3000	SPHWH1L5N603YEV3A1	YE	V3, V5	A1	58	580 – 620
		SPHWH1L5N603YEV5A1				62	620 – 660
	4000	SPHWH1L5N603YET3A1	YE	T3, T5	A1	62	620 – 660
		SPHWH1L5N603YET5A1				66	660 – 700
	5000	SPHWH1L5N603YER3A1	YE	R3, R5	A1	62	620 – 660
		SPHWH1L5N603YER5A1				66	660 – 700
	5700	SPHWH1L5N603YEQ3A1	YE	Q3, Q5	A1	62	620 – 660
		SPHWH1L5N603YEQ5A1				66	660 – 700
	6500	SPHWH1L5N603YEP3A1	YE	P3, P5	A1	62	620 – 660
		SPHWH1L5N603YEP5A1				62	620 – 660
80	2700K	SPHWH1L5N605YEW3A1	YE	W3, W5	A1	54	540 – 580
		SPHWH1L5N605YEW5A1				58	580 – 620
	3000K	SPHWH1L5N605YEV3A1	YE	V3, V5	A1	54	540 – 580
		SPHWH1L5N605YEV5A1				58	580 – 620
	3500K	SPHWH1L5N605YEU3A1	YE	U3, U5	A1	54	540 – 580
		SPHWH1L5N605YEU5A1				58	580 – 620
	4000K	SPHWH1L5N605YET3A1	YE	T3, T5	A1	58	580 – 620
		SPHWH1L5N605YET5A1				62	620 – 660
	5000K	SPHWH1L5N605YER3A1	YE	R3, R5	A1	58	580 – 620
		SPHWH1L5N605YER5A1				62	620 – 660
	5700K	SPHWH1L5N605YEQ3A1	YE	Q3, Q5	A1	58	580 – 620
		SPHWH1L5N605YEQ5A1				62	620 – 660
6500K	SPHWH1L5N605YEP3A1	YE	P3, P5	A1	58	580 – 620	
	SPHWH1L5N605YEP5A1				62	620 – 660	
90	2700K	SPHWH1L5N607YEW3A1 SPHWH1L5N607YEW5A1	YE	W3, W5	A1	42	420 – 460
						46	460 – 500
						50	500 – 540
	3000K	SPHWH1L5N607YEV3A1 SPHWH1L5N607YEV5A1	YE	V3, V5	A1	42	420 – 460
						46	460 – 500
						50	500 – 540
	3500K	SPHWH1L5N607YEU3A1 SPHWH1L5N607YEU5A1	YE	U3, U5	A1	42	420 – 460
						46	460 – 500
						50	500 – 540
	4000K	SPHWH1L5N607YET3A1 SPHWH1L5N607YET5A1	YE	T3, T5	A1	46	460 – 500
						50	500 – 540
						54	540 – 580

5000K	SPHWH1L5N607YER3A1 SPHWH1L5N607YER5A1	YE	R3, R5	A1	46	460 ~ 500
					50	500 ~ 540
					54	540 ~ 580
5700K	SPHWH1L5N607YEQ3A1 SPHWH1L5N607YEQ5A1	YE	Q3, Q5	A1	46	460 ~ 500
					50	500 ~ 540
					54	540 ~ 580

b) Voltage Bins (I_F = 640 mA, T_j = 25 °C)

Nominal CCT (K)	CRI (R _a) Min.	Product Code	Voltage Rank	Voltage Bin	Voltage Range (V)
-	-	-	YE	A0	5.8 ~ 6.0
				A1	6.0 ~ 6.2
				A2	6.2 ~ 6.4

c) Chromaticity Region & Coordinates ($I_F = 640 \text{ mA}$, $T_J = 85 \text{ }^\circ\text{C}$)



CRI	CCT	Rank	CIE x	CIE y	Φ	a	b
70 / 80 / 90	2700K	W3	0.4578	0.4101	53.7	0.0081	0.0042
		W5	0.4578	0.4101	53.7	0.0135	0.0070
	3000K	V3	0.4338	0.4030	53.2	0.0083	0.0041
		V5	0.4338	0.4030	53.2	0.0138	0.0068
	3500K	U3	0.4073	0.3917	54.0	0.0093	0.0041
		U5	0.4073	0.3917	54.0	0.0155	0.0069
	4000K	T3	0.3818	0.3797	53.7	0.0094	0.0040
		T5	0.3818	0.3797	53.7	0.0157	0.0067
	5000K	R3	0.3447	0.3553	59.6	0.0082	0.0035
		R5	0.3447	0.3553	59.6	0.0137	0.0058
	5700K	Q3	0.3287	0.3417	59.1	0.0075	0.0032
		Q5	0.3287	0.3417	59.1	0.0125	0.0053
	6500K	P3	0.3123	0.3282	58.6	0.0067	0.0029
		P5	0.3123	0.3282	58.6	0.0112	0.0048

Note : Samsung maintains measurement tolerance of: $C_x, C_y = \pm 0.005$

3. Typical Characteristic Graphs

a) Spectral Distribution ($I_f = 640 \text{ mA}$, $T_J = 25 \text{ }^\circ\text{C}$)

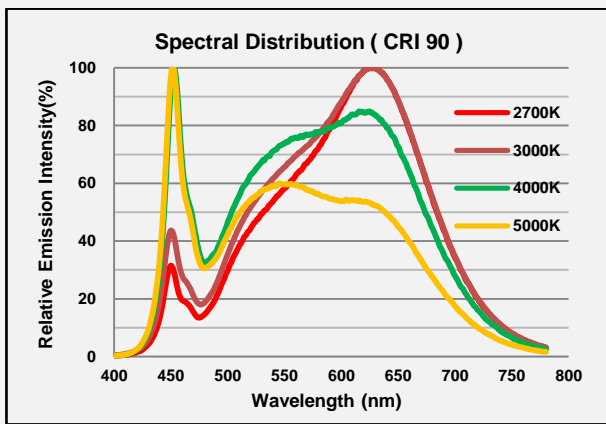
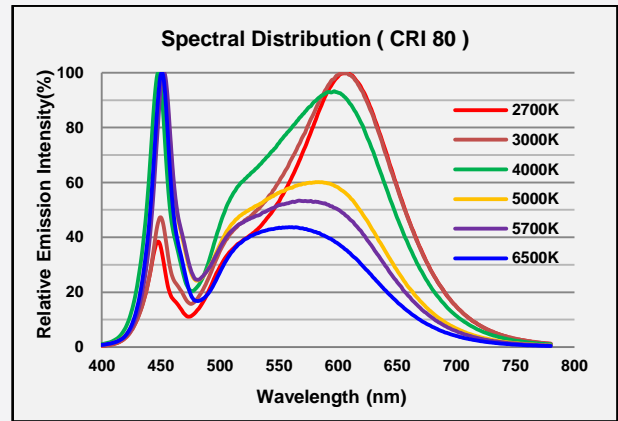
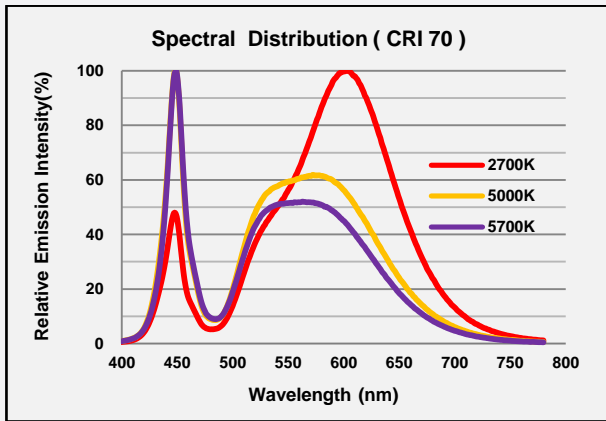

b) Forward Current Characteristics ($T_J = 25 \text{ }^\circ\text{C}$)

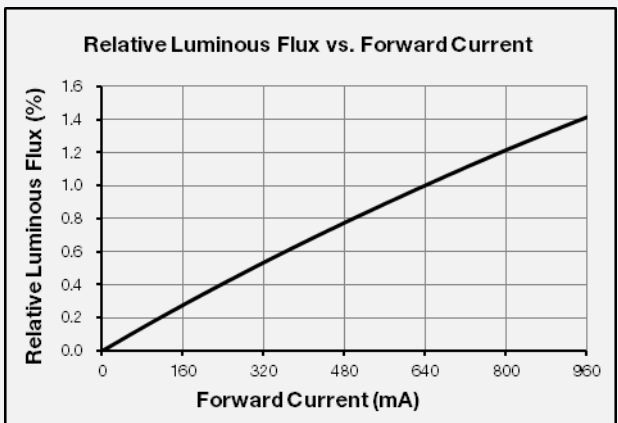
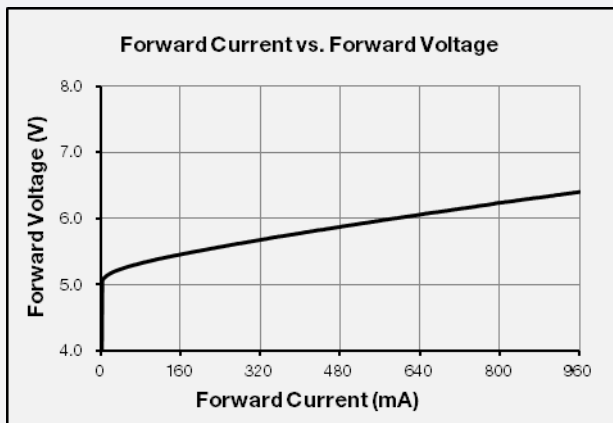

c) Temperature Characteristics ($I_F = 640 \text{ mA}$)

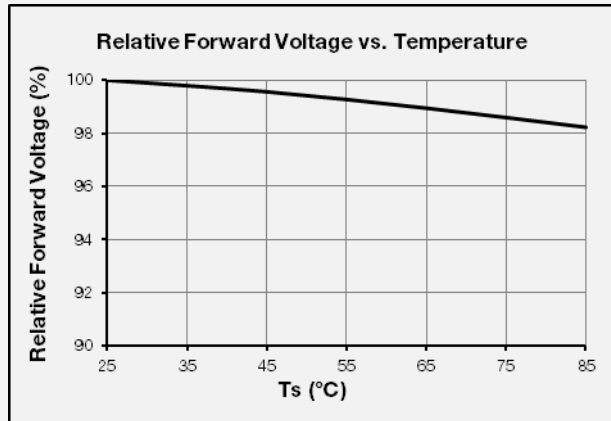

d) Color Shift Characteristics ($I_F = 640 \text{ mA}$, $T_J = 25 \text{ °C}$)

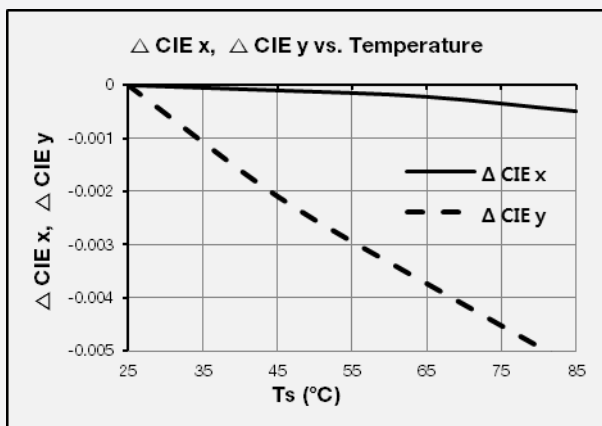

e) Beam Angle Characteristics ($I_F = 640 \text{ mA}$, $T_J = 25 \text{ °C}$)



4. Outline Drawing & Dimension

a) Mechanical Dimensions



Notes:

- 1) Mark for the Anode
- 2) Unit : mm
- 3) Tolerance : $\pm 0.1\text{mm}$

b) Recommended Solder Pad

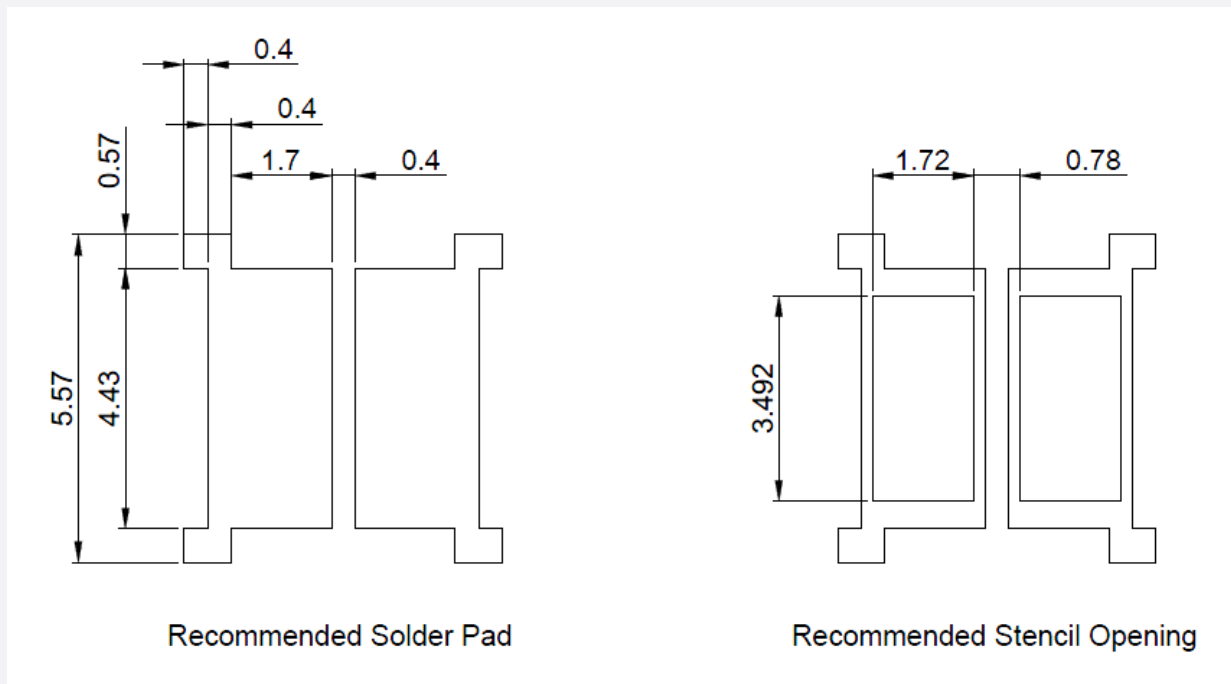

5. Reliability Test Items & Conditions

a) Test Items

Test Item	Test Condition	Test Hour / Cycle
High Temperature Life Test	85 °C, Derating IF	1000 h
High Temperature Humidity Life Test	60 °C, 90 % RH, Derating IF	1000 h
Low Temperature Life Test	-40 °C, Derating IF	1000 h
Powered Temperature Cycle Test	-45 °C / 20 min ↔ 85 °C / 20 min, sweep 100 min cycle on/off: each 5 min, Derating IF	100 cycles
Thermal Cycle	-45 °C / 15 min ↔ 125 °C / 15 min temperature change within 5 min	500 cycles
High Temperature Storage	100 °C	1000 h
Low Temperature Storage	-40 °C	1000 h
ESD (HBM)	 <p> R_1: 10 MΩ R_2: 1.5 kΩ C: 100 pF V: ± 4 kV </p>	5 times
ESD (MM)	R_1 : 10 M Ω R_2 : 0 C : 200 pF V : ± 0.4 kV	5 times
Vibration Test	20~2000~20 Hz, 200 m/s ² , sweep 4 min X, Y, Z 3 direction, each 1 cycle	4 cycles
Mechanical Shock Test	1500 g, 0.5 ms 3 shocks each X-Y-Z axis	5 cycles

b) Criteria for Judging the Damage

Item	Symbol	Test Condition ($T_s = 25$ °C)	Limit	
			Min	Max
Forward Voltage	V_F	$I_F = 640$ mA	Init. Value * 0.9	Init. Value * 1.1
Luminous Flux	Φ_V	$I_F = 640$ mA	Init. Value * 0.7	Init. Value * 1.1

6. Soldering Conditions

a) Reflow Conditions (Pb free)

Reflow frequency: 2 times max.



b) Manual Soldering Conditions

Not more than 5 seconds @ max. 300 °C, under soldering iron.

7. Tape & Reel

a) Taping Dimension

(unit: mm)

symbol	AO	BO	KO	PO	P1	P2
Spec	5.20±0.10	5.40±0.10	0.95±0.10	4.00±0.10	8.0±0.10	2.0±0.10
symbol	W	T	E	F	DO	D1
Spec	12.0±0.2	0.20±0.05	1.75±0.10	5.50±0.05	1.50+0.1/-0	1.50±0.10



Taping Direction



b) Reel Dimension (max 2,000 pcs)

(unit: mm)

**Notes:**

- 1) Quantity: The quantity/reel is 2000 pcs
- 2) All dimensions are millimeters (tolerance : $\pm 0.2\text{mm}$)
- 3) Packaging : P/N, Manufacturing data code no. and quantity are indicated on the aluminum packing bag.

8. Label Structure

a) Label Structure

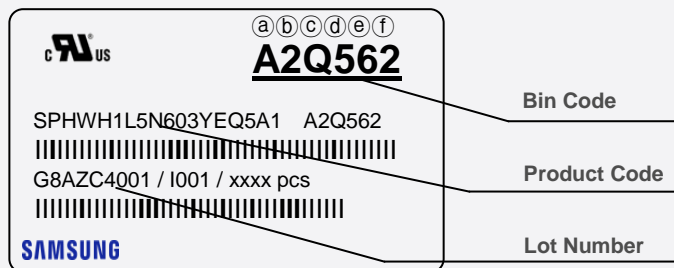

Note: Denoted bin code and product code above is only an example (see description on page 5)

Bin Code:

- ⒶⒷ: Forward Voltage bin (refer to page 7)
- ⒸⒹ: Chromaticity bin (refer to page 8)
- ⒺⒻ: Luminous Flux bin (refer to page 6)

b) Lot Number

The lot number is composed of the following characters:

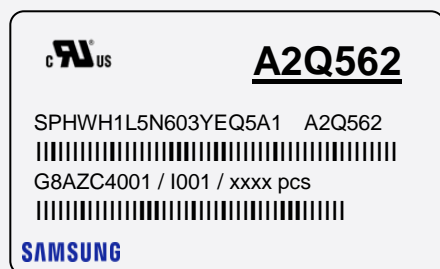

①②③④⑤⑥⑦⑧⑨ / IⒶⒷⒸ / xxxx pcs

- ①② : Production site (G8: Xiamen, China)
- ③ : Product state (A: Normal, B: Bulk, C: First Production, R: Reproduction, S: Sample)
- ④ : Year (B: 2017, C:2018, D:2019...)
- ⑤ : Month (1~9, A, B, C)
- ⑥ : Day (1~9, A, B~V)
- ⑦⑧⑨ : Samsung Electronics Product serial number (001 ~ 999)
- ⒶⒷⒸ : Reel number(001 ~ 999)



CAUTION

This bag contains
MOISTURE SENSITIVE DEVICES

LEVEL

2a

1. Shelf life in sealed bag: 12 months at <40°C and <90% relative humidity (RH)
2. Peak package body temperature: 240 °C
3. After this bag is opened, devices that will be subjected to reflow solder or other high temperature processes must be:
 - a. Mounted within 672 hours at factory conditions of equal to or less than 30°C /60% RH, or
 - b. Stored at <10% RH
4. Devices require bake, before mounting, if:
 - a. Humidity Indicator Card is >/60% when read at 23±5°C, or
 - b. 2a is not met.
5. If baking is required, devices must be baked for 10 ~ 24 hours at 60±5°C

Note: If device containers cannot be subjected to high temperature or shorter bake times are desired, reference IPC/JEDEC J-STD-033 for bake procedure.

Bag seal due date: _____
(If blank, see code label)

Note: Level and body temperature by IPC/JEDEC J-STD-020









■ 주의 사항

이 알루미늄 지퍼 백은 습기 및 정전기로부터 제품을 보호하기 위하여 제작되었습니다. 개봉 후에는 즉시 솔더 작업을 실시하는 것을 권장합니다.

습기 및 정전기로부터 제품을 보호 하기 위해서 개봉 후 사용하지 않는 자재는 본 팩에 넣어 보관 하시기 바랍니다. 사용하지 않는 자재를 본 팩에 넣을 때는 반드시 동봉된 드라이 팩과 함께 넣고 지퍼부분을 완전하게 밀봉하여 주시기 바랍니다.

■ Important

This Al Zipper bag is designed to protect the enclosed products from moisture and ESD. Once opened, the products should be soldered onto the printed circuit board immediately. When not in use, please do not leave the products unprotected by the Al Zipper Bag. To repack unused products., please ensure the zip-lock is completely sealed with the dry pack left inside.

On top of the box

b) Aluminum Vinyl Packing Bag

c) Humidity Indicator Card inside Aluminum Vinyl Bag





A2Q562

SPHWH1L5N603YEQ5A1 A2Q562
 I001 / xxxx pcs
 G8AZC4001 / I001 / xxxx pcs

SAMSUNG

10. Precautions in Handling & Use

- 1) For over-current protection, users are recommended to apply resistors connected in series with the LEDs to mitigate sudden change of the forward current caused by shift of forward voltage.
- 2) This device should not be used in any type of fluid such as water, oil, organic solvent, etc. When cleaning is required, IPA is recommended as the cleaning agent. Some solvent-based cleaning agent may damage the silicone resins used in the device.
- 3) When the device is in operation, the forward current should be carefully determined considering the maximum ambient temperature and corresponding junction temperature.
- 4) LEDs must be stored in a clean environment. If the LEDs are to be stored for three months or more after being shipped from Samsung, they should be packed with a nitrogen-filled container (shelf life of sealed bags is 12 months at temperature 0~40 °C, 0~90 % RH).
- 5) After storage bag is opened, device subjected to soldering, solder reflow, or other high temperature processes must be:
 - a. Mounted within 672 hours (28 days) at an assembly line with a condition of no more than 30 °C / 60 % RH, or
 - b. Stored at <10 % RH
- 6) Repack unused devices with anti-moisture packing, fold to close any opening and then store in a dry place.
- 7) Devices require baking before mounting, if humidity card reading is >60 % at 23 ± 5 °C.
- 8) Devices must be baked for 1 hour at 60 ± 5 °C, if baking is required.
- 9) The LEDs are sensitive to the static electricity and surge current. It is recommended to use a wrist band or anti-electrostatic glove when handling the LEDs. If voltage exceeding the absolute maximum rating is applied to LEDs, it may cause damage or even destruction to LED devices. Damaged LEDs may show some unusual characteristics such as increase in leakage current, lowered turn-on voltage, or abnormal lighting of LEDs at low current.
- 10) VOCs (Volatile Organic Compounds) can be generated from adhesives, flux, hardener or organic additives used in luminaires (fixtures). Transparent LED silicone encapsulant is permeable to those chemicals and they may lead to a discoloration of encapsulant when they exposed to heat or light. This phenomenon can cause a significant loss of light emitted (output) from the luminaires. In order to prevent these problems, we recommend users to know the physical properties of materials used in luminaires and they must be carefully selected.
- 11) Risk of sulfurization (or tarnishing)
 The LED from Samsung Electronics Co., Ltd. uses a silver-plated lead frame and its surface color may change to black (or dark colored) when it is exposed to sulfur (S), chlorine (Cl) or other halogen compound. Sulfurization of lead frame may cause intensity degradation, change of chromaticity coordinates and, in extreme cases, open circuit. It requires caution. Due to possible sulfurization of lead frame, LED should not be used and stored together with oxidizing substances made of materials such as: rubber, plain paper, lead solder cream, etc.

Legal and additional information.

[About Samsung Electronics Co., Ltd.](#)

Samsung Electronics Co., Ltd. inspires the world and shapes the future with transformative ideas and technologies, redefining the worlds of TVs, smartphones, wearable devices, tablets, cameras, digital appliances, printers, medical equipment, network systems and semiconductors.

We are also leading in the Internet of Things space through, among others, our Digital Health and Smart Home initiatives. We employ 307,000 people across 84 countries. To discover more, please visit our official website at www.samsung.com and our official blog at global.samsungtomorrow.com.

Copyright © 2018 Samsung Electronics Co., Ltd. All rights reserved.

Samsung is a registered trademark of Samsung Electronics Co., Ltd.

Specifications and designs are subject to change without notice. Non-metric weights and measurements are approximate. All data were deemed correct at time of creation. Samsung is not liable for errors or omissions. All brand, product, service names and logos are trademarks and/or registered trademarks of their respective owners and are hereby recognized and acknowledged.

Samsung Electronics Co., Ltd.

95, Samsung 2-ro

Giheung-gu

Yongin-si, Gyeonggi-do, 446-711

KOREA

www.samsungled.com

SAMSUNG

Looking for pricing, stock, or lifecycle information?

Click below to explore more details on WIN SOURCE:

- ⊖ [View SPHWH1L5N605YEV5A1 on WIN SOURCE](#)
- ⊖ [Samsung Information](#)

Optimize Your Supply Chain with WIN SOURCE Solutions

- ✓ Global Sourcing Solution
- ✓ Obsolete Management
- ✓ Cost Control Management
- ✓ Shortage Management
- ✓ Alternative Solution
- ✓ Excess Inventory Management