



**THE DATASHEET OF
SCP7TT78HEL1TLS06E**



Middle Power LED Series Flip Chip Package

LM101B

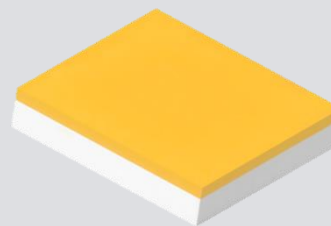

New technology provides high performance and energy conservation

Features & Benefits

- Greater freedom of design with compact package size
- High degree of reliability with plastic-free structure
- Low thermal resistance
- High efficiency providing optimized solution

Table of Contents

1.	Characteristics	-----	3
2.	Product Code Information	-----	6
3.	Typical Characteristics Graphs	-----	15
4.	Outline Drawing & Dimension	-----	17
5.	Reliability Test Items & Conditions	-----	19
6.	Soldering Conditions	-----	20
7.	Tape & Reel	-----	21
8.	Label Structure	-----	23
9.	Packing Structure	-----	24
10.	Precautions in Handling & Use	-----	26

1. Characteristics

a) Absolute Maximum Rating

Item	Symbol	Rating	Unit	Condition
Operating Temperature	T_a	-40 ~ +105	°C	-
Storage Temperature	T_{stg}	-40 ~ +120	°C	-
LED Junction Temperature	T_j	125	°C	-
Forward Current	I_F	350	mA	-
Assembly Process Temperature	-	260 <10	°C s	-
ESD (HBM)	-	±2	kV	-

Note:

Proper current derating must be observed to maintain junction temperature below the maximum at all time.

It is recommended minimum current 10mA in order to avoid un-even brightness, and may vary depending on circuit configuration.

b) Electro-optical Characteristics ($I_F = 150 \text{ mA}$, $T_s = 85 \text{ }^\circ\text{C}$)

Item	Unit	Rank	Bin	Min.	Typ.	Max.
Forward Voltage (V_f)	V	6E	6A	2.7	-	2.9
			AE	2.9	-	3.1
Reverse Voltage (@ $-10 \mu\text{A}$)	V			-10.0	-	-
Color Rendering Index (R_a)	-	7		70	-	-
		8		80	-	-
		9		90	-	-
Special CRI (R9)	-	7		-40	-	-
		8		0	-	-
		9		50	-	-
Thermal Resistance (junction to chip point)	K/W			-	2	-
Beam Angle	°			-	120	-

Note: Samsung maintains measurement tolerance of : Forward voltage = $\pm 0.1 \text{ V}$, Luminous flux = $\pm 5 \%$, CRI = ± 3 , R9 = ± 6.5

c) Luminous Flux Characteristics (I_F = 150 mA, T_s = 85 °C)

CRI	Nominal CCT (K)	SA		SB		SC		SD		SE		SF		SG		SH		SJ	
		Min.	Max.	Min.	Max.	Min.	Max.	Min.	Max.	Min.	Max.	Min.	Max.	Min.	Max.	Min.	Max.	Min.	Max.
		43	47	47	51	51	55	55	59	59	63	63	67	67	71	71	75	75	79
70	2700																		
	3000																		
	3500																		
	4000																		
	5000																		
	5700																		
	6500																		
80	2000																		
	2200																		
	2700																		
	3000																		
	3500																		
	4000																		
	5000																		
	5700																		
	6500																		
90	2700																		
	3000																		
	3500																		
	4000																		
	5000																		

Note:

- 1) The LM101B is tested in pulsed condition at rated test current (10ms pulse width)
- 2) Calculated flux values are for reference only
- 3) Samsung maintains measurement tolerance of : luminous flux = $\pm 5\%$

2. Product Code Information ($I_f = 150 \text{ mA}$, $T_s = 85 \text{ }^\circ\text{C}$)

1	2	3	4	5	6	7	8	9	10	11	12	13	14	15	16	17	18
S	C	P	8	W	T	7	8	H	E	L	1	W	L	S	0	6	E

Digit	PKG Information	Code	Specification
1 2 3	Samsung Chip	SCP	
4	CRI	7 8 9	Min. 70 Min. 80 Min. 90
5	CCT (K)	Z Y W V U T R Q P	2000 2200 2700 3000 3500 4000 5000 5700 6500
6	Chip Shape	T	Square
7 8 9	Chip Code	78H	
10 11 12	Product Purpose	EL1	FeC for Lighting
13	CCT (K)	Y W V U T R Q P	2200K 2700K 3000K 3500K 4000K 5000K 5700K 6500K
14	MacAdam Step	L U	Single Bin for MacAdam 5-step L(MacAdam 5-step Bin) Single Bin for MacAdam 3-step U(MacAdam 3-step Bin) * Note : CRI90 Only MacAdam 3-step
15 16	Luminous Flux (lm)	S0	Bin Code: SY, SZ, SA, SB, SC, SD, SE, SF, SG, SH
17 18	Forward Voltage (V)	6E	2.7~3.1 Bin Code: 6A 2.7~2.9 AE 2.9~3.1

a) Luminous Flux Bins ($I_f = 150 \text{ mA}$, $T_s = 85 \text{ °C}$)

CRI (R _a) Min.	Nominal CCT (K)	Product Code	Flux Bin	Flux Range (Φ _v , lm)	
70	2700	SCP7WT78HEL1W☆S06E	SE	59 ~ 63	
			SF	63 ~ 67	
			SG	67 ~ 71	
	3000	SCP7VT78HEL1V☆S06E	SF	63 ~ 67	
			SG	67 ~ 71	
			SH	71 ~ 75	
	3500	SCP7UT78HEL1U☆S06E	SF	63 ~ 67	
			SG	67 ~ 71	
			SH	71 ~ 75	
	4000	SCP7TT78HEL1T☆S06E	SG	67 ~ 71	
			SH	71 ~ 75	
			SJ	75 ~ 79	
	5000	SCP7RT78HEL1R☆S06E	SG	67 ~ 71	
			SH	71 ~ 75	
			SJ	75 ~ 79	
	5700	SCP7QT78HEL1Q☆S06E	SF	63 ~ 67	
			SG	67 ~ 71	
			SH	71 ~ 75	
	6500	SCP7PT78HEL1P☆S06E	SF	63 ~ 67	
			SG	67 ~ 71	
				SH	71 ~ 75

Note: “☆” can be “L” (Single bin for MacAdam 5-step), “U” (Single bin for MacAdam 3-step)

a) Luminous Flux Bins ($I_f = 150 \text{ mA}$, $T_s = 85 \text{ °C}$)

CRI (R_a) Min.	Nominal CCT (K)	Product Code	Flux Bin	Flux Range (Φ_v , lm)
80	2000	SCP8ZT78HEL1Z☆S06E	SA	43 ~ 47
			SB	47 ~ 51
			SC	51 ~ 55
	2200	SCP8YT78HEL1Y☆S06E	SB	47 ~ 51
			SC	51 ~ 55
			SD	55 ~ 59
	2700	SCP8WT78HEL1W☆S06E	SE	59 ~ 63
			SF	63 ~ 67
			SG	67 ~ 71
	3000	SCP8VT78HEL1V☆S06E	SE	59 ~ 63
			SF	63 ~ 67
			SG	67 ~ 71
	3500	SCP8UT78HEL1U☆S06E	SF	63 ~ 67
			SG	67 ~ 71
			SH	71 ~ 75
	4000	SCP8TT78HEL1T☆S06E	SF	63 ~ 67
			SG	67 ~ 71
			SH	71 ~ 75
	5000	SCP8RT78HEL1R☆S06E	SF	63 ~ 67
			SG	67 ~ 71
			SH	71 ~ 75
	5700	SCP8QT78HEL1Q☆S06E	SF	63 ~ 67
			SG	67 ~ 71
			SH	71 ~ 75
6500	SCP8PT78HEL1P☆S06E	SE	59 ~ 63	
		SF	63 ~ 67	
			SG	67 ~ 71

Note: “☆” can be “L” (Single bin for MacAdam 5-step) “U” (Single bin for MacAdam 3-step)

a) Luminous Flux Bins ($I_f = 150 \text{ mA}$, $T_s = 85 \text{ °C}$)

CRI (R _a) Min.	Nominal CCT (K)	Product Code	Flux Bin	Flux Range (Φ _v , lm)
90	2700	SCP9WT78HEL1WUS06E	SB	47 ~ 51
			SC	51 ~ 55
			SD	55 ~ 59
	3000	SCP9VT78HEL1VUS06E	SB	47 ~ 51
			SC	51 ~ 55
			SD	55 ~ 59
	3500	SCP9UT78HEL1UUS06E	SB	47 ~ 51
			SC	51 ~ 55
			SD	55 ~ 59
	4000	SCP9TT78HEL1TUS06E	SC	51 ~ 55
			SD	55 ~ 59
			SE	59 ~ 63
5000	SCP9RT78HEL1RUS06E	SC	51 ~ 55	
		SD	55 ~ 59	
		SE	59 ~ 63	

Note: “☆” can be “L” (Single bin for MacAdam 5-step), “U” (Single bin for MacAdam 3-step)

b) Color Bins ($I_F = 150 \text{ mA}$, $T_s = 85 \text{ }^\circ\text{C}$)

CRI Min.	Nominal CCT (K)	Product Code	Color Rank	Chromaticity Bins
70	2700	SCP7WT78HEL1W☆S06E	WL	WL
			WU	WU
	3000	SCP7VT78HEL1V☆S06E	VL	VL
			VU	VU
	3500	SCP7UT78HE1U☆S06E	UL	UL
			UU	UU
	4000	SCP7TT78HEL1T☆S06E	TL	TL
			TU	TU
	5000	SCP7RT78HEL1R☆S06E	RL	RL
			RU	RU
	5700	SCP7QT78HEL1Q☆S06E	QL	QL
			QU	QU
	6500	SCP7PT78HEL1P☆S06E	PL	PL
			PU	PU
80	2000	SCP8ZT78HEL1Z☆S06E	ZL	ZL
			ZU	ZU
	2200	SCP8YT78HEL1Y☆S06E	YL	YL
			YU	YU
	2700	SCP8WT78HEL1W☆S06E	WL	WL
			WU	WU
	3000	SCP8VT78HEL1V☆S06E	VL	VL
			VU	VU
	3500	SCP8UT78HEL1U☆S06E	UL	UL
			UU	UU
	4000	SCP8TT78HEL1T☆S06E	TL	TL
			TU	TU
	5000	SCP8RT78HEL1R☆S06E	RL	RL
			RU	RU
5700	SCP8QT78HEL1Q☆S06E	QL	QL	
		QU	QU	
6500	SCP8PT78HEL1P☆S06E	PL	PL	
		PU	PU	
90	2700	SCP9WT78HEL1WUS06E	WU	WU
	3000	SCP9VT78HEL1VUS06E	VU	VU
	3500	SCP9UT78HEL1UUS06E	UU	UU
	4000	SCP9TT78HEL1TUS06E	TU	TU
	5000	SCP9RT78HEL1RUS06E	RU	RU

Note: “☆” can be “L” (Single bin for MacAdam 5-step), “U” (Single bin for MacAdam 3-step), CRI90 Only MacAdam 3-step

c) Voltage Bins ($I_f = 150 \text{ mA}$, $T_s = 85 \text{ °C}$)

Nominal CCT (K)	CRI Min.	Product Code	Voltage Rank	Voltage Bin	Voltage Range (V)
			6E	6A	2.7 ~ 2.9
				AE	2.9 ~ 3.1

d) Chromaticity Region & Coordinates ($I_F = 150 \text{ mA}$, $T_s = 85 \text{ }^\circ\text{C}$) : "L" (Single bin for MacAdam 5-step)

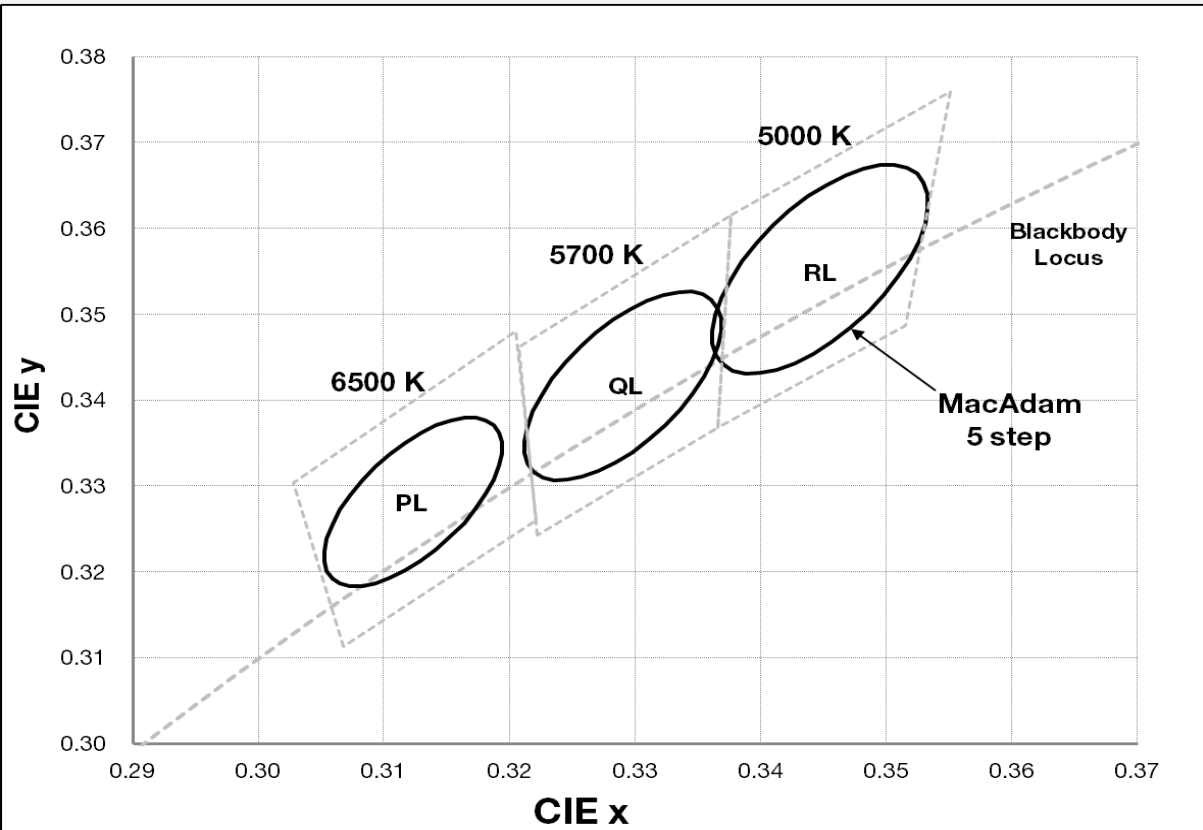
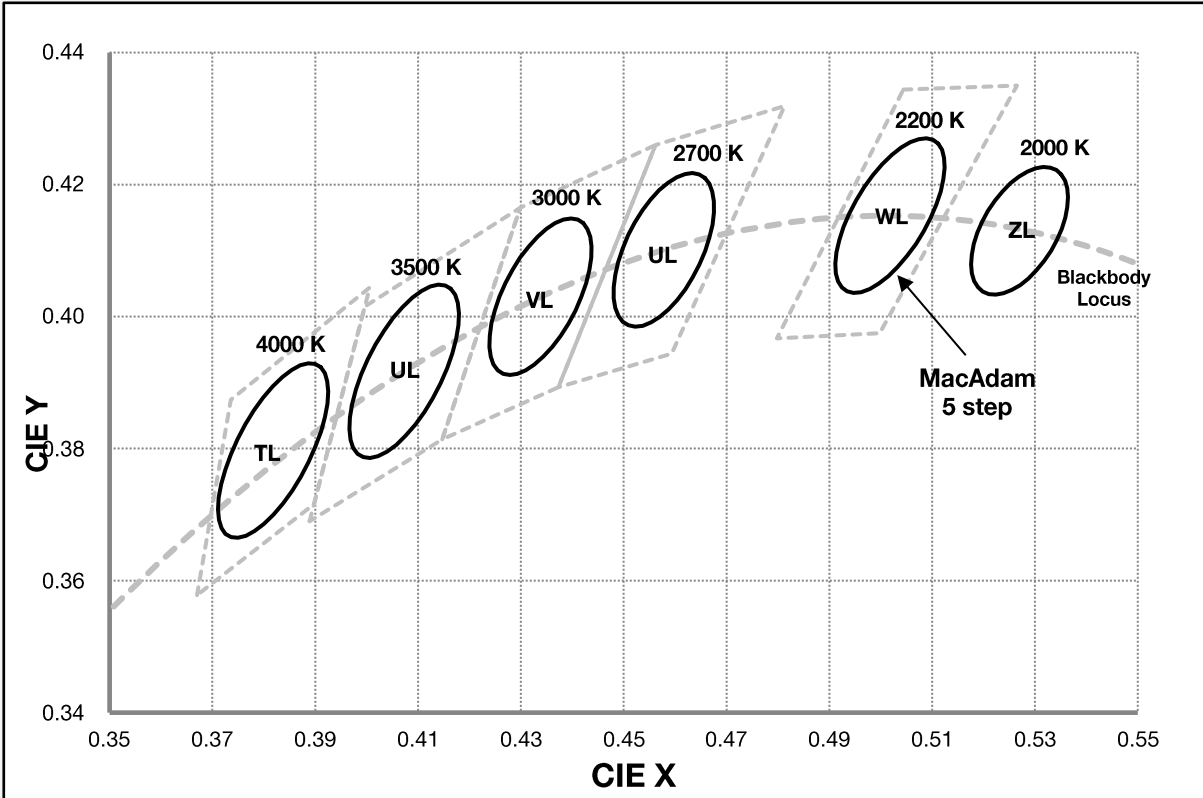

d) Chromaticity Region & Coordinates ($I_F = 150 \text{ mA}$, $T_s = 85 \text{ }^\circ\text{C}$) : "U" (Single bin for MacAdam 3-step)



d) Chromaticity Region & Coordinates ($I_F = 150 \text{ mA}$, $T_s = 85 \text{ }^\circ\text{C}$)

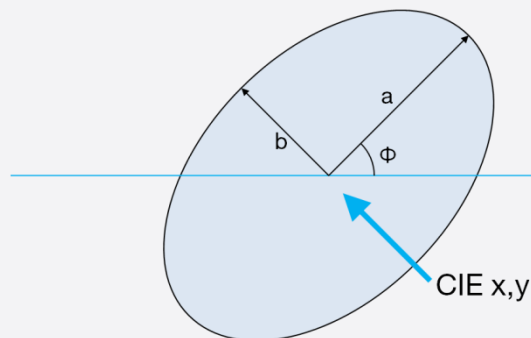

	CCT (K)	Center point		Major-axis	Minor-axis	Rotation
		CIE x	CIE y	a	b	Φ
3 step (U code)	2000	0.5270	0.4130	0.0072	0.0040	46.44
	2200	0.5018	0.4153	0.0086	0.0040	49.27
	2700	0.4578	0.4101	0.0081	0.0042	53.70
	3000	0.4338	0.4030	0.0083	0.0041	53.22
	3500	0.4073	0.3917	0.0093	0.0041	54.00
	4000	0.3818	0.3797	0.0094	0.0040	53.72
	5000	0.3447	0.3553	0.0082	0.0035	59.62
	5700	0.3287	0.3417	0.0075	0.0032	59.10
	6500	0.3123	0.3282	0.0067	0.0029	58.57
5 step (L code)	2000	0.5270	0.4130	0.0118	0.0066	46.44
	2200	0.5018	0.4153	0.0144	0.0066	49.27
	2700	0.4578	0.4101	0.0135	0.0070	53.70
	3000	0.4338	0.4030	0.0138	0.0068	53.22
	3500	0.4073	0.3917	0.0155	0.0068	54.00
	4000	0.3818	0.3797	0.0157	0.0067	53.72
	5000	0.3447	0.3553	0.0137	0.0058	59.62
	5700	0.3287	0.3417	0.0125	0.0053	59.10
	6500	0.3123	0.3282	0.0112	0.0048	58.57

Note: Samsung maintains measurement tolerance of: $C_x, C_y = \pm 0.005$

3. Typical Characteristics Graphs

a) Spectrum Distribution ($I_f = 150 \text{ mA}$, $T_s = 85 \text{ }^\circ\text{C}$)

CCT: 2700 K, CRI80

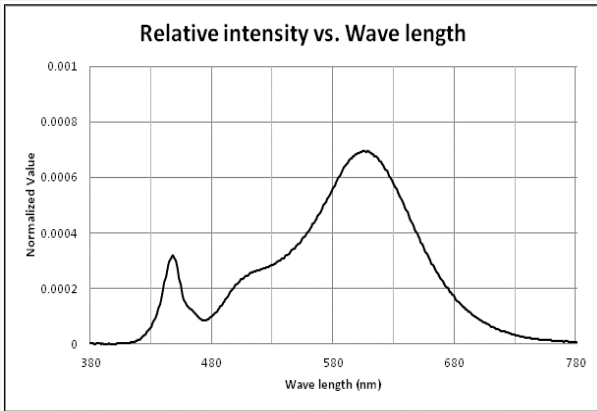

CCT: 5000 K, CRI80

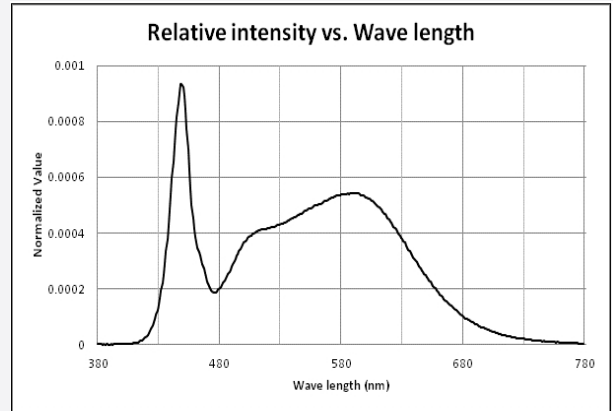

b) Forward Current Characteristics ($T_s = 85 \text{ }^\circ\text{C}$)

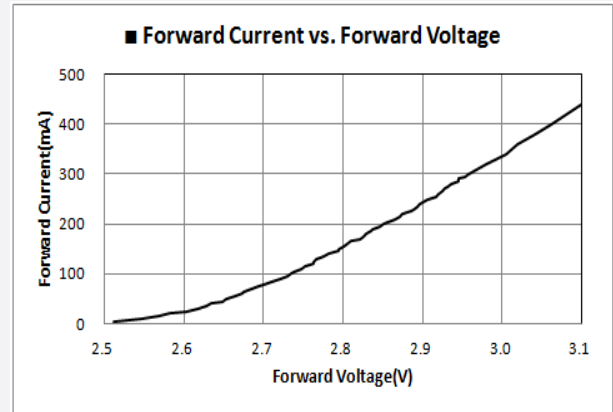
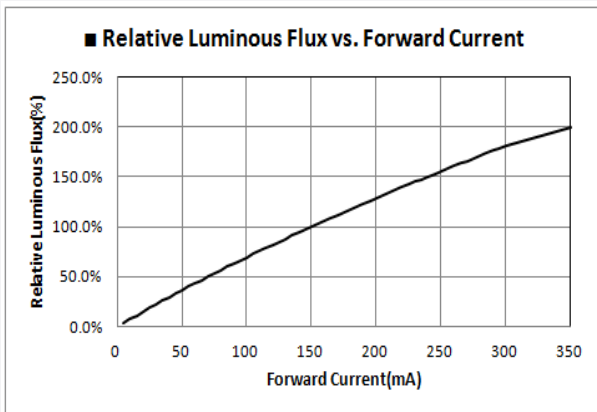

c) Temperature Characteristics ($I_f = 150 \text{ mA}$)

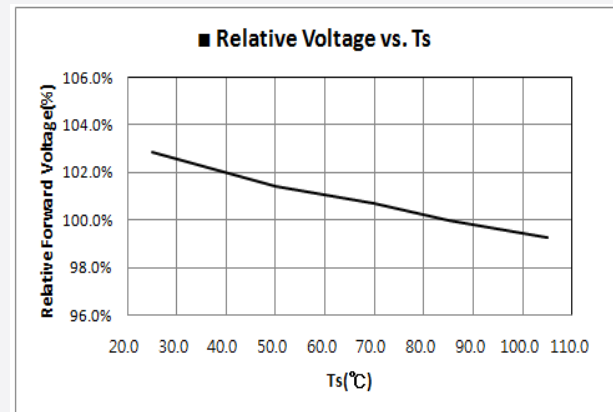
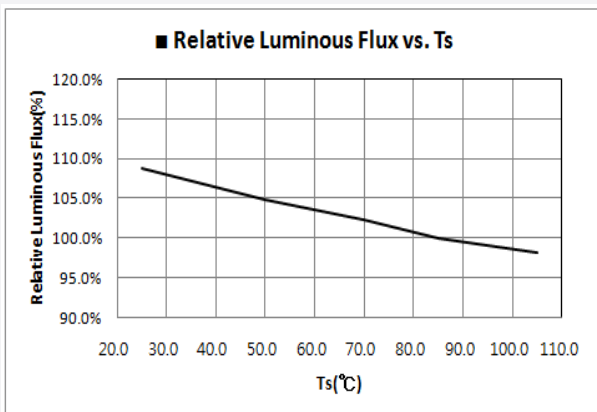

d) Color Shift Characteristics ($T_s = 85^\circ\text{C}$, $I_f = 150\text{ mA}$)

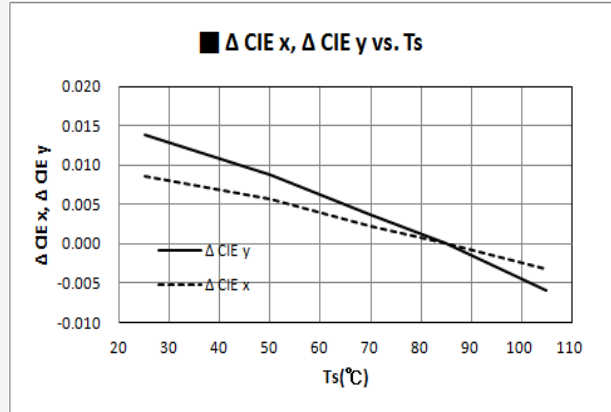
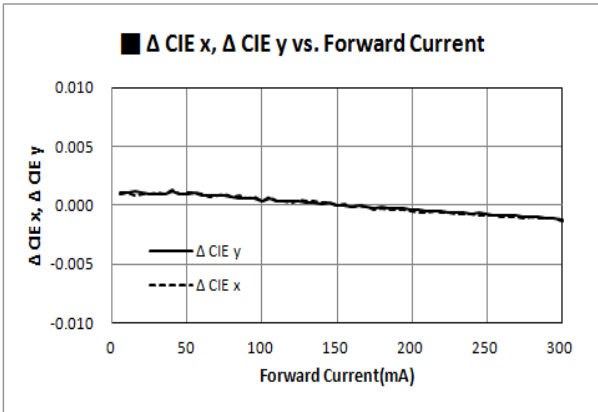

e) Derating Curve

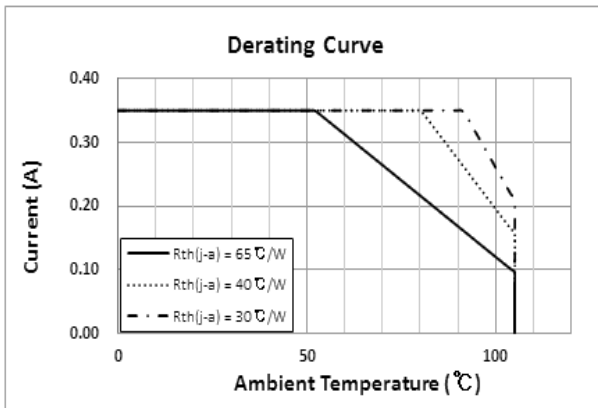

R_{th} is measured after soldering of LED chip on the metal based substrate.
 *metal: aluminum (refer to page 17)

f) Beam Angle Characteristics ($I_f = 150\text{ mA}$)

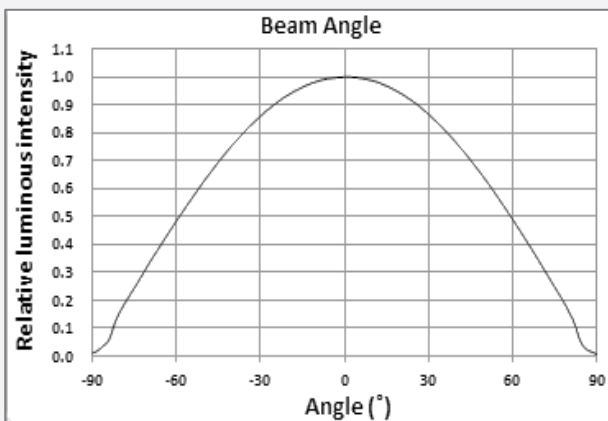

4. Outline Drawing & Dimension

1. Tolerance is ± 0.10 mm
2. Do not place LEDs with pressure

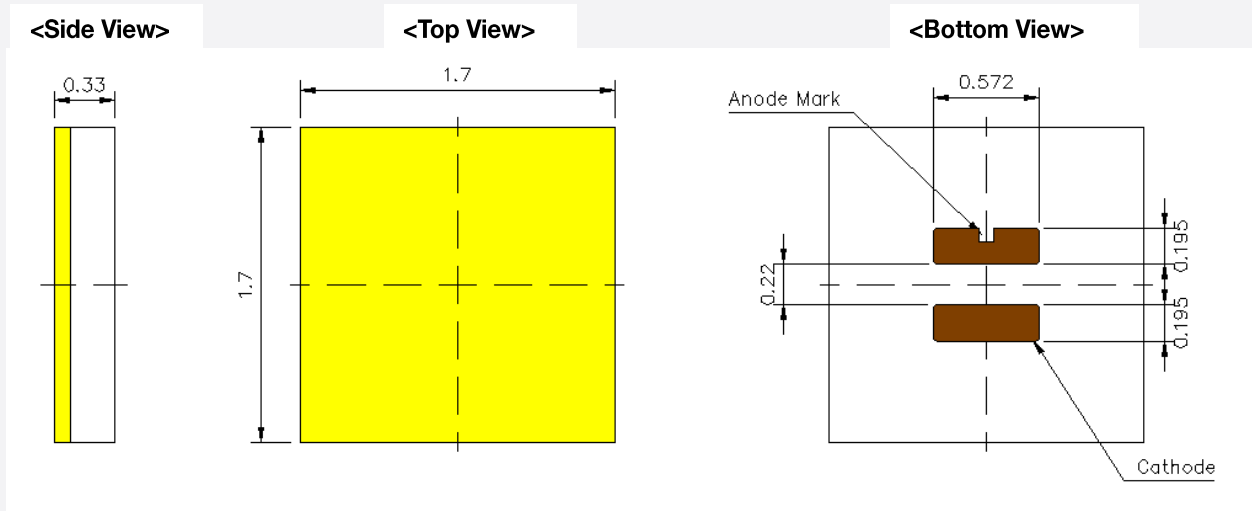

- Measurement unit: mm
- Tolerance: ± 0.10 mm

Precautions:

- 1) Pressure on the LEDs will influence to the reliability of the LEDs. Precautions should be taken to avoid strong pressure on the LEDs. Do not put stress on the LEDs during heating.
- 2) Re-soldering should not be done after the LEDs have been soldered. If re-soldering is unavoidable, LED's characteristics should be carefully checked before and after such repair.
- 3) Do not stack assembled PCBs together. Since materials of LEDs is soft, abrasion between two PCB assembled with LED might cause catastrophic failure of the LEDs.

T_s Point & Measurement Method:

Measure nearest point from the center of LED chip (δ) as shown below.

Distance between chip center and T_s point (δ) = 3.5 mm

$T_j = T_s + \text{Power} \times \text{Thermal resistance at } T_s (R_{j-s})$

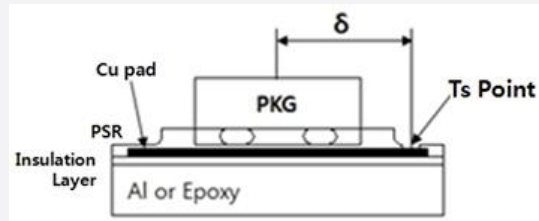
**Precautions:**

- 4) This LED chip PKG does not contain built-in ESD protection device.
- 5) Pressure on the LEDs will influence to the reliability of the LEDs. Precautions should be taken to avoid strong pressure on the LEDs. Do not put stress on the LEDs during heating.
- 6) Re-soldering should not be done after the LEDs have been soldered. If re-soldering is unavoidable, LED's characteristics should be carefully checked before and after such repair.
- 7) Do not stack assembled PCBs together. Since materials of LEDs is soft, abrasion between two PCB assembled with LED might cause catastrophic failure of the LEDs

5. Reliability Test Items & Conditions

a) Test Items

Test Item	Test Condition	Test Hour / Cycle
Room Temperature Life Test	25 °C, Derated max current	1000 h
High Temperature Life Test	85 °C, Derated max current	1000 h
High Temperature Humidity Life Test	85 °C, 85 % RH, Derated max current	1000 h
Low Temperature Life Test	-40 °C, DC Derated max current	1000 h
Powered Temperature Cycle Test	-45 °C / 20 min ↔ 85 °C / 20 min, sweep 100 min cycle on/off: each 5 min, Derated max current	100 cycles
Temperature Cycling	-45 °C / 15 min ↔ 125 °C / 15 min → Hot plate 180 °C	500 cycles
High Temperature Storage	120 °C	1000 h
Low Temperature Storage	-40 °C	1000 h
ESD (HBM)	 <p> R_1: 10 MΩ R_2: 1.5 kΩ C: 100 pF V: ± 2 kV </p>	5 times
Vibration Test	20~2000~20 Hz, 200 m/s ² , sweep 4 min X, Y, Z 3 direction, each 1 cycle	4 cycles
Mechanical Shock Test	1500 g, 0.5 ms	5 cycles

b) Criteria for Judging the Damage

Item	Symbol	Test Condition ($T_s = 25$ °C)	Limit	
			Min	Max
Forward Voltage	V_F	$I_F =$ Derated max current	Init. Value * 0.9	Init. Value * 1.1
Luminous Flux	Φ_v	$I_F =$ Derated max current	Init. Value * 0.7	Init. Value * 1.1

6. Soldering Conditions

a) Reflow Conditions (Pb free)

Reflow frequency: 2 times max.

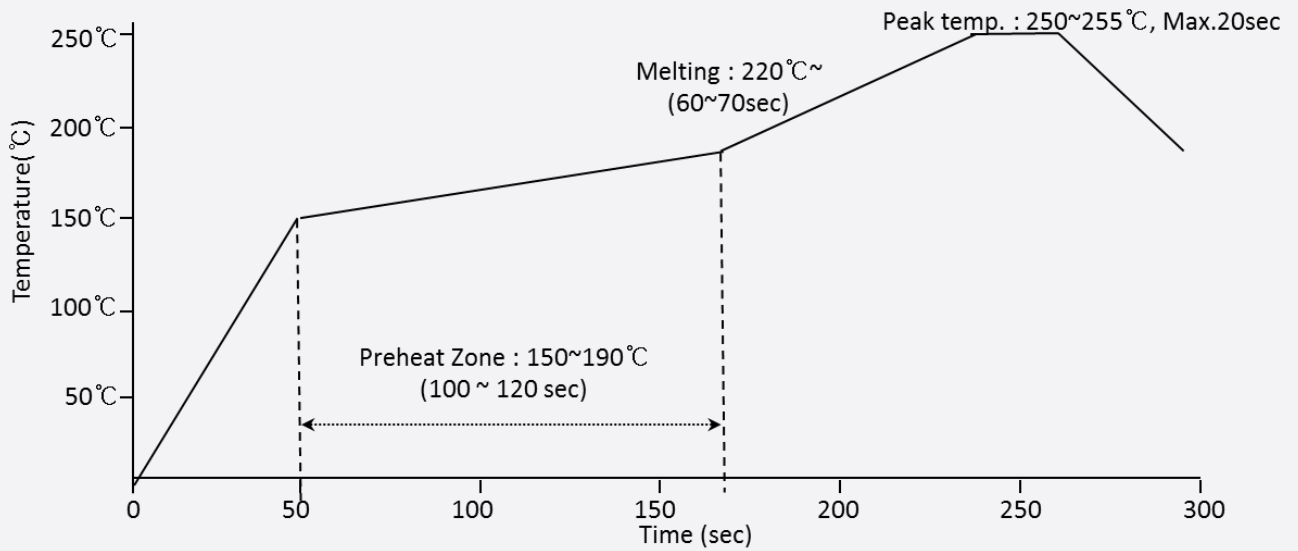

b) Manual Soldering Conditions

Not more than 5 seconds @ max. 300 °C, under soldering iron

7. Tape & Reel

a) Taping Dimension

(unit: mm)

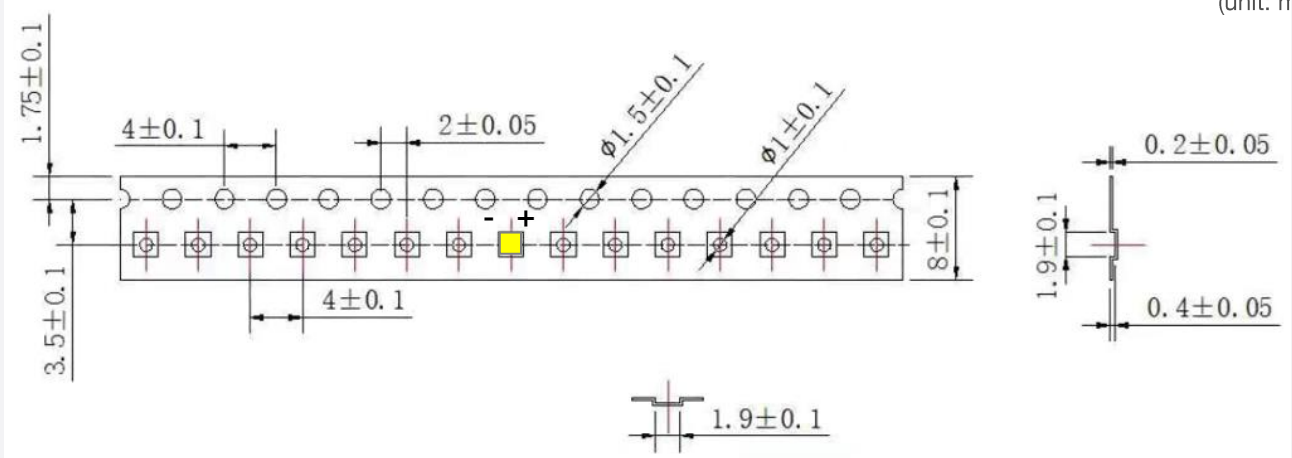

Taping Direction

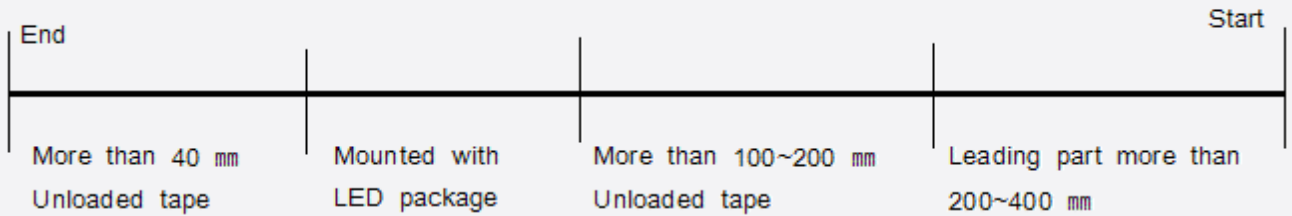

b) Reel Dimension

(unit: mm)

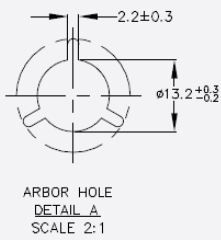
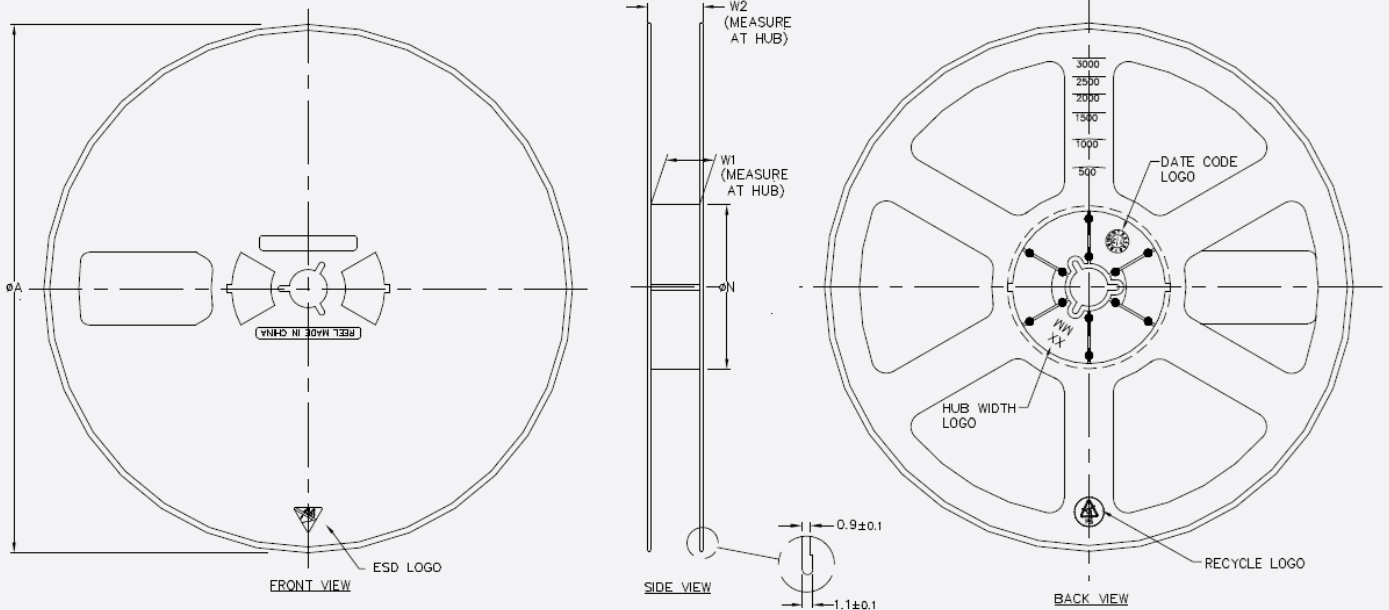

PRODUCT SPECIFICATIONS				
TAPE WIDTH	ϕA ± 1.0	ϕN ± 0.5	$W1$ ± 0.5	$W2$ (MAX)
08MM	$\phi 178.0$	54.0	9.5	15.0
12MM	$\phi 178.0$	54.0	13.5	19.0

Notes:

- 1) Quantity: 4,000 Qty/reel
- 2) Cumulative tolerance: Cumulative tolerance / 10 pitches is ± 0.2 mm
- 3) Packaging: P/N, Manufacturing data code no. and quantity are indicated on the aluminum packing bag

8. Label Structure

a) Label Structure

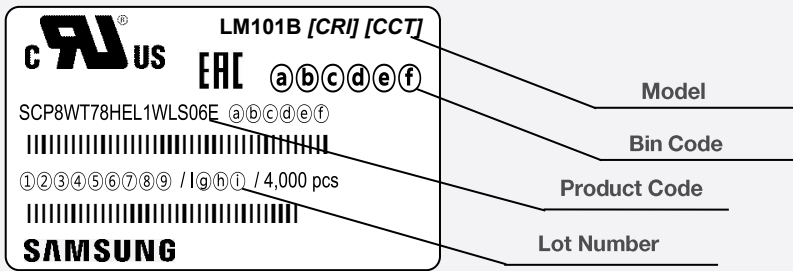

Note: Denoted product code and bin code above is only an example

Bin Code:

- ⓐⓑ: Chromaticity bin (refer to page 10-14)
- ⓒⓓ: Luminous Flux bin (refer to page 7-9)
- ⓔⓕ: Forward Voltage bin (refer to page 11)

b) Lot Number

The lot number is composed of the following characters:



①②③④⑤⑥⑦⑧⑨ / I**a****b****c** / 4,000 pcs

- ① ② : Production site (GB: Nanchang China)
- ③ : Product state (A: Normal, B: Bulk, C: First Production, R: Reproduction, S: Sample)
- ④ : Year (Z: 2015, A: 2016, ..., E: 2020, ...)
- ⑤ : Month (1~9, A, B, C)
- ⑥ : Day (1~9, A, B~V)
- ⑦⑧⑨ : Product serial number (001 ~ 999)
- ⑨**h**① : Reel number (001 ~ 999) or (AAA ~ ZZZ)

9. Packing Structure

a) Packing Process

Reel

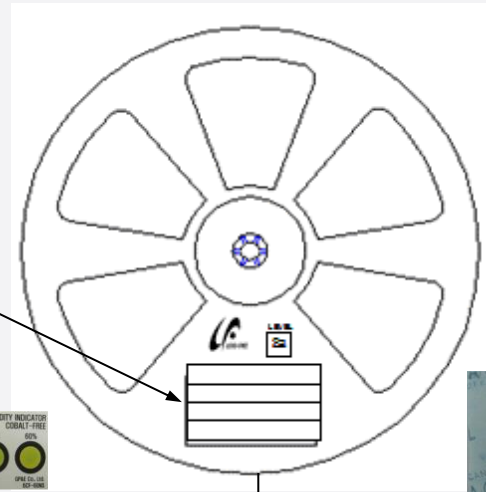
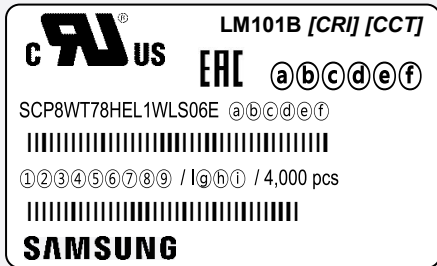

Aluminum Vinyl Bag



Outer Box

Material: Paper (SW3B(A))

Type	Size (mm)			Note
	L	W	H	
7 inch	295 ± 5	290 ± 5	260 ± 5	Max 10 reels

① Side Label

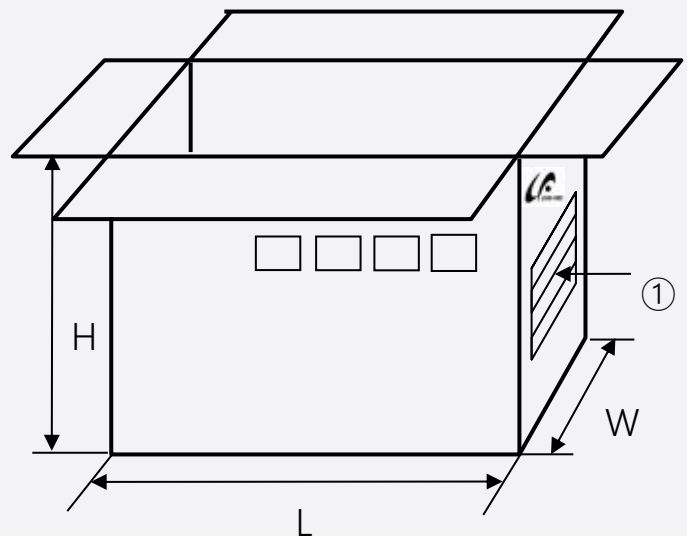
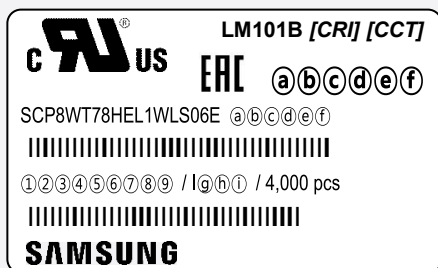

b) Aluminum Vinyl Packing Bag



CAUTION

This bag contains
MOISTURE SENSITIVE DEVICES

LEVEL
2a

1. Shelf life in sealed bag: 12 months at <40°C and <90% relative humidity (RH)
2. Peak package body temperature: 240 °C
3. After this bag is opened, devices that will be subjected to reflow solder or other high temperature processes must be:
 - a. Mounted within 672 hours at factory conditions of equal to or less than 30°C /60% RH, or
 - b. Stored at <10% RH
4. Devices require bake, before mounting, if:
 - a. Humidity Indicator Card is >65% when read at 23±5°C, or
 - b. 2a is not met.
5. If baking is required, devices must be baked for 1 hours at 60±5°C

Note: If device containers cannot be subjected to high temperature or shorter bake times are desired, reference IPC/JEDEC J-STD-033 for bake procedure.

Bag seal due date: _____

(If blank, see code label)

Note: Level and body temperature by IPC/JEDEC J-STD-020



LM101B [CRL] [CCT]

US EAC (a)(b)(c)(d)(e)(f)

SCP8WT78HEL1WLS06E (a)(b)(c)(d)(e)(f)

①②③④⑤⑥⑦⑧⑨ / I@h① / 4,000 pcs

SAMSUNG



LEAD-FREE



ATTENTION
OBSERVE PRECAUTIONS
FOR HANDLING
ELECTROSTATIC
SENSITIVE
DEVICES



OTHER

주의 사항

이 알루미늄 지퍼 팩은 습기 및 정전기로부터 제품을 보호하기 위하여 제작되었습니다. 개봉 후에는 즉시 솔더 작업을 실시하는 것을 권장합니다.

습기 및 정전기로부터 제품을 보호 하기 위해서 개봉 후 사용하지 않는 자재는 본 팩에 넣어 보관 하시기 바랍니다. 사용하지 않는 자재를 본 팩에 넣을 때는 반드시 동봉된 드라이 팩과 함께 넣고 지퍼부분을 완전하게 밀봉하여 주시기 바랍니다.

Important

This Al Zipper bag is designed to protect the enclosed products from moisture and ESD. Once opened, the products should be soldered onto the printed circuit board immediately. When not in use, please do not leave the products unprotected by the Al Zipper Bag. To repack unused products., please ensure the zip-lock is completely sealed with the dry pack left inside.

c) Silica Gel & Humidity Indicator Card inside Aluminum Vinyl Bag

HUMIDITY INDICATOR

Cobalt-Free

10%	20%	30%	40%	50%	60%

T-PC-D

DANGER IF AZURE, CHANGE DESICCANT

Read at Lavender Between Azure & Brown

SAMSUNG

10. Precautions in Handling & Use

- 1) For over-current-proof function, customers are recommended to apply resistors to prevent sudden change of the current caused by slight shift of the voltage.
- 2) This device should not be used in any type of fluid such as water, oil, organic solvent, etc. When washing is required, IPA is recommended to use.
- 3) When the LEDs illuminate, operating current should be decided after considering the ambient maximum temperature.
- 4) LEDs must be stored in a clean environment. Shelf life of sealed bags: 12 months, temperature ~40 °C, ~90 % RH.
- 5) After storage bag is opened, device subjected to soldering, solder reflow, or other high temperature processes must be:
 - a. Mounted within 672 hours (28 days) at an assembly line with a condition of no more than 30 °C / 60 % RH, or
 - b. Stored at <10 % RH
- 6) Repack unused products with anti-moisture packing, fold to close any opening and then store in a dry place.
- 7) Devices require baking before mounting, if humidity card reading is >60 % at 23 ± 5 °C.
- 8) Devices must be baked for 1 hour at 60 ± 5 °C, if baking is required.
- 9) The LEDs are sensitive to the static electricity and surge. It is recommended to use a wrist band or anti-electrostatic glove when handling the LEDs. If voltage exceeding the absolute maximum rating is applied to LEDs, it may cause damage or even destruction to LED devices. Damaged LEDs may show some unusual characteristics such as increase in leak current, lowered turn-on voltage, or abnormal lighting of LEDs at low current.
- 10) VoCs (Volatile Organic Compounds) can be generated from adhesives, flux, hardener or organic additives used in luminaires (fixtures). LED silicone encapsulant is permeable to those chemicals and they may lead to a discoloration of encapsulant when they exposed to heat or light. This phenomenon can cause a significant loss of light emitted (output) from the luminaires. In order to prevent these problems, we recommend users to know the physical properties of materials used in luminaires and they must be carefully selected.
- 11) Risk of sulfurization (or tarnishing)

The LED from Samsung does not use a silver-plated lead frame but if the LED is attached in silver-plated substrate, the surface color of substrate may change to black (or dark colored) when it is exposed to sulfur (S), chlorine (Cl) or other halogen compound. Sulfurization of substrate may cause intensity degradation, change of chromaticity coordinates and, in extreme cases, open circuit. It requires caution. Due to possible sulfurization of substrate, LED should not be used and stored together with oxidizing substances made of materials such as rubber, plain paper, lead solder cream, etc.

Legal and additional information.

[About Samsung Electronics Co., Ltd.](#)

Samsung inspires the world and shapes the future with transformative ideas and technologies.

The company is redefining the worlds of TVs, smartphones, wearable devices, tablets, digital appliances, network systems, and memory, system LSI, foundry and LED solutions. For the latest news, please visit the Samsung Newsroom at news.samsung.com.

US\$216.7 billion. To discover more, please visit www.samsungled.com.

Copyright © 2020 Samsung Electronics Co., Ltd. All rights reserved.

Samsung is a registered trademark of Samsung Electronics Co., Ltd.

Specifications and designs are subject to change without notice. Non-metric weights and measurements are approximate. All data were deemed correct at time of creation. Samsung is not liable for errors or omissions. All brand, product, service names and logos are trademarks and/or registered trademarks of their respective owners and are hereby recognized and acknowledged.

Samsung Electronics Co., Ltd.

95, Samsung 2-ro

Giheung-gu

Yongin-si, Gyeonggi-do, 446-711

KOREA

www.samsungled.com

SAMSUNG

Looking for pricing, stock, or lifecycle information?

Click below to explore more details on WIN SOURCE:

- ⊖ [View SCP7TT78HEL1TLS06E on WIN SOURCE](#)
- ⊖ [Samsung Information](#)

Optimize Your Supply Chain with WIN SOURCE Solutions

- ✓ Global Sourcing Solution
- ✓ Obsolete Management
- ✓ Cost Control Management
- ✓ Shortage Management
- ✓ Alternative Solution
- ✓ Excess Inventory Management