



**THE DATASHEET OF  
SCP7QT78HEL1QUS06E**



## Middle Power LED Series Flip Chip Package

# LM101B

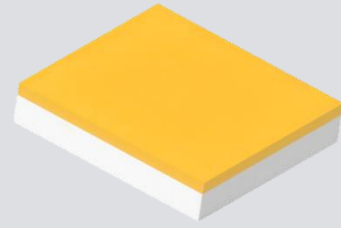

New technology provides high performance and energy conservation

### Features & Benefits

- Greater freedom of design with compact package size
- High degree of reliability with plastic-free structure
- Low thermal resistance
- High efficiency providing optimized solution

## Table of Contents

|     |                                     |       |    |
|-----|-------------------------------------|-------|----|
| 1.  | Characteristics                     | ----- | 3  |
| 2.  | Product Code Information            | ----- | 6  |
| 3.  | Typical Characteristics Graphs      | ----- | 15 |
| 4.  | Outline Drawing & Dimension         | ----- | 17 |
| 5.  | Reliability Test Items & Conditions | ----- | 19 |
| 6.  | Soldering Conditions                | ----- | 20 |
| 7.  | Tape & Reel                         | ----- | 21 |
| 8.  | Label Structure                     | ----- | 23 |
| 9.  | Packing Structure                   | ----- | 24 |
| 10. | Precautions in Handling & Use       | ----- | 26 |

## 1. Characteristics

### a) Absolute Maximum Rating

| Item                         | Symbol    | Rating     | Unit    | Condition |
|------------------------------|-----------|------------|---------|-----------|
| Operating Temperature        | $T_a$     | -40 ~ +105 | °C      | -         |
| Storage Temperature          | $T_{stg}$ | -40 ~ +120 | °C      | -         |
| LED Junction Temperature     | $T_j$     | 125        | °C      | -         |
| Forward Current              | $I_F$     | 350        | mA      | -         |
| Assembly Process Temperature | -         | 260<br><10 | °C<br>s | -         |
| ESD (HBM)                    | -         | ±2         | kV      | -         |

#### Note:

Proper current derating must be observed to maintain junction temperature below the maximum at all time.

It is recommended minimum current 10mA in order to avoid un-even brightness, and may vary depending on circuit configuration.

**b) Electro-optical Characteristics (I<sub>F</sub> = 150 mA, T<sub>s</sub> = 85 °C)**

| Item   | Unit | Rank | Bin | Min.  | Typ. | Max. |
|--|------|------|-----|-------|------|------|
| Forward Voltage (V <sub>F</sub> )              | V    | 6E   | 6A  | 2.7   | -    | 2.9  |
|  |      |      | AE  | 2.9   | -    | 3.1  |
| Reverse Voltage<br>(@ -10 μA)                  | V    |      |     | -10.0 | -    | -    |
| Color Rendering Index (R <sub>a</sub> )        | -    | 7    |     | 70    | -    | -    |
|  |      | 8    |     | 80    | -    | -    |
|  |      | 9    |     | 90    | -    | -    |
| Special CRI (R9)                               | -    | 7    |     | -40   | -    | -    |
|  |      | 8    |     | 0     | -    | -    |
|  |      | 9    |     | 50    | -    | -    |
| Thermal Resistance<br>(junction to chip point) | K/W  |      |     | -     | 2    | -    |
| Beam Angle                                     | °    |      |     | -     | 120  | -    |

**Note:** Samsung maintains measurement tolerance of : Forward voltage = ±0.1 V, Luminous flux = ±5 %, CRI = ±3, R9 = ±6.5

**c) Luminous Flux Characteristics (I<sub>F</sub> = 150 mA, T<sub>s</sub> = 85 °C)**

| CRI | Nominal CCT (K) | SA   |      | SB   |      | SC   |      | SD   |      | SE   |      | SF   |      | SG   |      | SH   |      | SJ   |      |
|-----|-----------------|------|------|------|------|------|------|------|------|------|------|------|------|------|------|------|------|------|------|
|     |                 | Min. | Max. | Min. | Max. | Min. | Max. | Min. | Max. | Min. | Max. | Min. | Max. | Min. | Max. | Min. | Max. | Min. | Max. |
|     |                 | 43   | 47   | 47   | 51   | 51   | 55   | 55   | 59   | 59   | 63   | 63   | 67   | 67   | 71   | 71   | 75   | 75   | 79   |
| 70  | 2700            |      |      |      |      |      |      |      |      |      |      |      |      |      |      |      |      |      |      |
|     | 3000            |      |      |      |      |      |      |      |      |      |      |      |      |      |      |      |      |      |      |
|     | 3500            |      |      |      |      |      |      |      |      |      |      |      |      |      |      |      |      |      |      |
|     | 4000            |      |      |      |      |      |      |      |      |      |      |      |      |      |      |      |      |      |      |
|     | 5000            |      |      |      |      |      |      |      |      |      |      |      |      |      |      |      |      |      |      |
|     | 5700            |      |      |      |      |      |      |      |      |      |      |      |      |      |      |      |      |      |      |
|     | 6500            |      |      |      |      |      |      |      |      |      |      |      |      |      |      |      |      |      |      |
| 80  | 2000            |      |      |      |      |      |      |      |      |      |      |      |      |      |      |      |      |      |      |
|     | 2200            |      |      |      |      |      |      |      |      |      |      |      |      |      |      |      |      |      |      |
|     | 2700            |      |      |      |      |      |      |      |      |      |      |      |      |      |      |      |      |      |      |
|     | 3000            |      |      |      |      |      |      |      |      |      |      |      |      |      |      |      |      |      |      |
|     | 3500            |      |      |      |      |      |      |      |      |      |      |      |      |      |      |      |      |      |      |
|     | 4000            |      |      |      |      |      |      |      |      |      |      |      |      |      |      |      |      |      |      |
|     | 5000            |      |      |      |      |      |      |      |      |      |      |      |      |      |      |      |      |      |      |
|     | 5700            |      |      |      |      |      |      |      |      |      |      |      |      |      |      |      |      |      |      |
|     | 6500            |      |      |      |      |      |      |      |      |      |      |      |      |      |      |      |      |      |      |
| 90  | 2700            |      |      |      |      |      |      |      |      |      |      |      |      |      |      |      |      |      |      |
|     | 3000            |      |      |      |      |      |      |      |      |      |      |      |      |      |      |      |      |      |      |
|     | 3500            |      |      |      |      |      |      |      |      |      |      |      |      |      |      |      |      |      |      |
|     | 4000            |      |      |      |      |      |      |      |      |      |      |      |      |      |      |      |      |      |      |
|     | 5000            |      |      |      |      |      |      |      |      |      |      |      |      |      |      |      |      |      |      |

**Note:**

- 1) The LM101B is tested in pulsed condition at rated test current (10ms pulse width)
- 2) Calculated flux values are for reference only
- 3) Samsung maintains measurement tolerance of : luminous flux =  $\pm 5\%$



a) Luminous Flux Bins ( $I_f = 150 \text{ mA}$ ,  $T_s = 85 \text{ °C}$ )

| CRI (R <sub>a</sub> )<br>Min. | Nominal CCT<br>(K) | Product Code       | Flux Bin | Flux Range<br>(Φ <sub>v</sub> , lm) |         |
|-------------------------------|--------------------|--------------------|----------|-------------------------------------|---------|
| 70                            | 2700               | SCP7WT78HEL1W☆S06E | SE       | 59 ~ 63                             |         |
|                               |                    |                    | SF       | 63 ~ 67                             |         |
|                               |                    |                    | SG       | 67 ~ 71                             |         |
|                               | 3000               | SCP7VT78HEL1V☆S06E | SF       | 63 ~ 67                             |         |
|                               |                    |                    | SG       | 67 ~ 71                             |         |
|                               |                    |                    | SH       | 71 ~ 75                             |         |
|                               | 3500               | SCP7UT78HEL1U☆S06E | SF       | 63 ~ 67                             |         |
|                               |                    |                    | SG       | 67 ~ 71                             |         |
|                               |                    |                    | SH       | 71 ~ 75                             |         |
|                               | 4000               | SCP7TT78HEL1T☆S06E | SG       | 67 ~ 71                             |         |
|                               |                    |                    | SH       | 71 ~ 75                             |         |
|                               |                    |                    | SJ       | 75 ~ 79                             |         |
|                               | 5000               | SCP7RT78HEL1R☆S06E | SG       | 67 ~ 71                             |         |
|                               |                    |                    | SH       | 71 ~ 75                             |         |
|                               |                    |                    | SJ       | 75 ~ 79                             |         |
|                               | 5700               | SCP7QT78HEL1Q☆S06E | SF       | 63 ~ 67                             |         |
|                               |                    |                    | SG       | 67 ~ 71                             |         |
|                               |                    |                    | SH       | 71 ~ 75                             |         |
|                               | 6500               | SCP7PT78HEL1P☆S06E | SF       | 63 ~ 67                             |         |
|                               |                    |                    | SG       | 67 ~ 71                             |         |
|                               |                    |                    |          | SH                                  | 71 ~ 75 |

**Note:** “☆” can be “L” (Single bin for MacAdam 5-step), “U” (Single bin for MacAdam 3-step)

a) Luminous Flux Bins ( $I_f = 150 \text{ mA}$ ,  $T_s = 85 \text{ °C}$ )

| CRI ( $R_a$ )<br>Min. | Nominal CCT<br>(K) | Product Code       | Flux Bin | Flux Range<br>( $\Phi_v$ , lm) |
|-----------------------|--------------------|--------------------|----------|--------------------------------|
| 80                    | 2000               | SCP8ZT78HEL1Z☆S06E | SA       | 43 ~ 47                        |
|                       |                    |                    | SB       | 47 ~ 51                        |
|                       |                    |                    | SC       | 51 ~ 55                        |
|                       | 2200               | SCP8YT78HEL1Y☆S06E | SB       | 47 ~ 51                        |
|                       |                    |                    | SC       | 51 ~ 55                        |
|                       |                    |                    | SD       | 55 ~ 59                        |
|                       | 2700               | SCP8WT78HEL1W☆S06E | SE       | 59 ~ 63                        |
|                       |                    |                    | SF       | 63 ~ 67                        |
|                       |                    |                    | SG       | 67 ~ 71                        |
|                       | 3000               | SCP8VT78HEL1V☆S06E | SE       | 59 ~ 63                        |
|                       |                    |                    | SF       | 63 ~ 67                        |
|                       |                    |                    | SG       | 67 ~ 71                        |
|                       | 3500               | SCP8UT78HEL1U☆S06E | SF       | 63 ~ 67                        |
|                       |                    |                    | SG       | 67 ~ 71                        |
|                       |                    |                    | SH       | 71 ~ 75                        |
|                       | 4000               | SCP8TT78HEL1T☆S06E | SF       | 63 ~ 67                        |
|                       |                    |                    | SG       | 67 ~ 71                        |
|                       |                    |                    | SH       | 71 ~ 75                        |
|                       | 5000               | SCP8RT78HEL1R☆S06E | SF       | 63 ~ 67                        |
|                       |                    |                    | SG       | 67 ~ 71                        |
|                       |                    |                    | SH       | 71 ~ 75                        |
|                       | 5700               | SCP8QT78HEL1Q☆S06E | SF       | 63 ~ 67                        |
|                       |                    |                    | SG       | 67 ~ 71                        |
|                       |                    |                    | SH       | 71 ~ 75                        |
| 6500                  | SCP8PT78HEL1P☆S06E | SE                 | 59 ~ 63  |                                |
|                       |                    | SF                 | 63 ~ 67  |                                |
|                       |                    |                    | SG       | 67 ~ 71                        |

**Note:** “☆” can be “L” (Single bin for MacAdam 5-step) “U” (Single bin for MacAdam 3-step)

**a) Luminous Flux Bins ( $I_f = 150 \text{ mA}$ ,  $T_s = 85 \text{ }^\circ\text{C}$ )**

| CRI ( $R_a$ )<br>Min. | Nominal CCT<br>(K) | Product Code       | Flux Bin | Flux Range<br>( $\Phi_v$ , lm) |
|-----------------------|--------------------|--------------------|----------|--------------------------------|
| 90                    | 2700               | SCP9WT78HEL1WUS06E | SB       | 47 ~ 51                        |
|                       |                    |                    | SC       | 51 ~ 55                        |
|                       |                    |                    | SD       | 55 ~ 59                        |
|                       | 3000               | SCP9VT78HEL1VUS06E | SB       | 47 ~ 51                        |
|                       |                    |                    | SC       | 51 ~ 55                        |
|                       |                    |                    | SD       | 55 ~ 59                        |
|                       | 3500               | SCP9UT78HEL1UUS06E | SB       | 47 ~ 51                        |
|                       |                    |                    | SC       | 51 ~ 55                        |
|                       |                    |                    | SD       | 55 ~ 59                        |
|                       | 4000               | SCP9TT78HEL1TUS06E | SC       | 51 ~ 55                        |
|                       |                    |                    | SD       | 55 ~ 59                        |
|                       |                    |                    | SE       | 59 ~ 63                        |
| 5000                  | SCP9RT78HEL1RUS06E | SC                 | 51 ~ 55  |                                |
|                       |                    | SD                 | 55 ~ 59  |                                |
|                       |                    | SE                 | 59 ~ 63  |                                |

**Note:** “☆” can be “L” (Single bin for MacAdam 5-step), “U” (Single bin for MacAdam 3-step)

b) Color Bins ( $I_F = 150 \text{ mA}$ ,  $T_s = 85 \text{ }^\circ\text{C}$ )

| CRI Min. | Nominal CCT (K)    | Product Code       | Color Rank | Chromaticity Bins |
|----------|--------------------|--------------------|------------|-------------------|
| 70       | 2700               | SCP7WT78HEL1W☆S06E | WL         | WL                |
|          |                    |                    | WU         | WU                |
|          | 3000               | SCP7VT78HEL1V☆S06E | VL         | VL                |
|          |                    |                    | VU         | VU                |
|          | 3500               | SCP7UT78HE1U☆S06E  | UL         | UL                |
|          |                    |                    | UU         | UU                |
|          | 4000               | SCP7TT78HEL1T☆S06E | TL         | TL                |
|          |                    |                    | TU         | TU                |
|          | 5000               | SCP7RT78HEL1R☆S06E | RL         | RL                |
|          |                    |                    | RU         | RU                |
|          | 5700               | SCP7QT78HEL1Q☆S06E | QL         | QL                |
|          |                    |                    | QU         | QU                |
|          | 6500               | SCP7PT78HEL1P☆S06E | PL         | PL                |
|          |                    |                    | PU         | PU                |
| 80       | 2000               | SCP8ZT78HEL1Z☆S06E | ZL         | ZL                |
|          |                    |                    | ZU         | ZU                |
|          | 2200               | SCP8YT78HEL1Y☆S06E | YL         | YL                |
|          |                    |                    | YU         | YU                |
|          | 2700               | SCP8WT78HEL1W☆S06E | WL         | WL                |
|          |                    |                    | WU         | WU                |
|          | 3000               | SCP8VT78HEL1V☆S06E | VL         | VL                |
|          |                    |                    | VU         | VU                |
|          | 3500               | SCP8UT78HEL1U☆S06E | UL         | UL                |
|          |                    |                    | UU         | UU                |
|          | 4000               | SCP8TT78HEL1T☆S06E | TL         | TL                |
|          |                    |                    | TU         | TU                |
|          | 5000               | SCP8RT78HEL1R☆S06E | RL         | RL                |
|          |                    |                    | RU         | RU                |
| 5700     | SCP8QT78HEL1Q☆S06E | QL                 | QL         |                   |
|          |                    | QU                 | QU         |                   |
| 6500     | SCP8PT78HEL1P☆S06E | PL                 | PL         |                   |
|          |                    | PU                 | PU         |                   |
| 90       | 2700               | SCP9WT78HEL1WUS06E | WU         | WU                |
|          | 3000               | SCP9VT78HEL1VUS06E | VU         | VU                |
|          | 3500               | SCP9UT78HEL1UUS06E | UU         | UU                |
|          | 4000               | SCP9TT78HEL1TUS06E | TU         | TU                |
|          | 5000               | SCP9RT78HEL1RUS06E | RU         | RU                |

**Note:** “☆” can be “L” (Single bin for MacAdam 5-step), “U” (Single bin for MacAdam 3-step), CRI90 Only MacAdam 3-step

**c) Voltage Bins ( $I_f = 150 \text{ mA}$ ,  $T_s = 85 \text{ °C}$ )**

| Nominal CCT (K) | CRI Min. | Product Code | Voltage Rank | Voltage Bin | Voltage Range (V) |
|-----------------|----------|--------------|--------------|-------------|-------------------|
|                 |          |              | 6E           | 6A          | 2.7 ~ 2.9         |
|                 |          |              |              | AE          | 2.9 ~ 3.1         |

d) Chromaticity Region & Coordinates ( $I_F = 150 \text{ mA}$ ,  $T_s = 85 \text{ }^\circ\text{C}$ ) : "L" (Single bin for MacAdam 5-step)

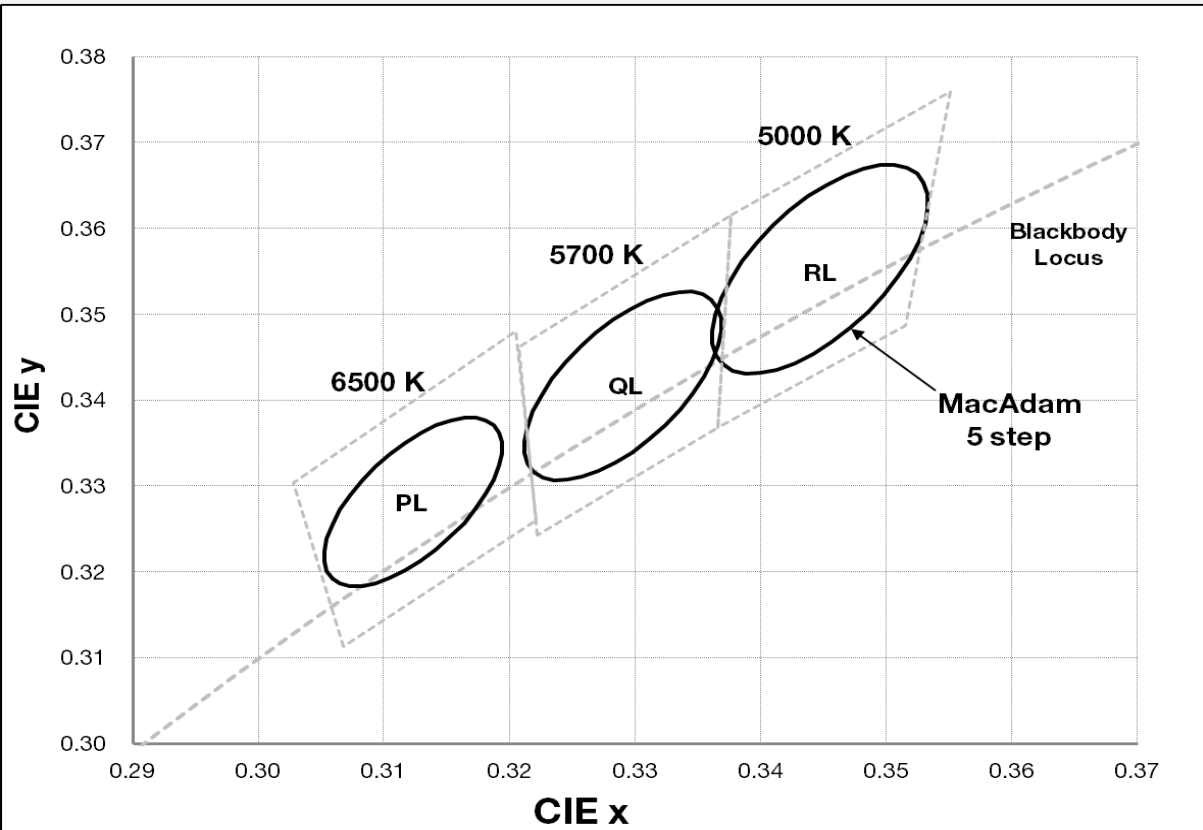
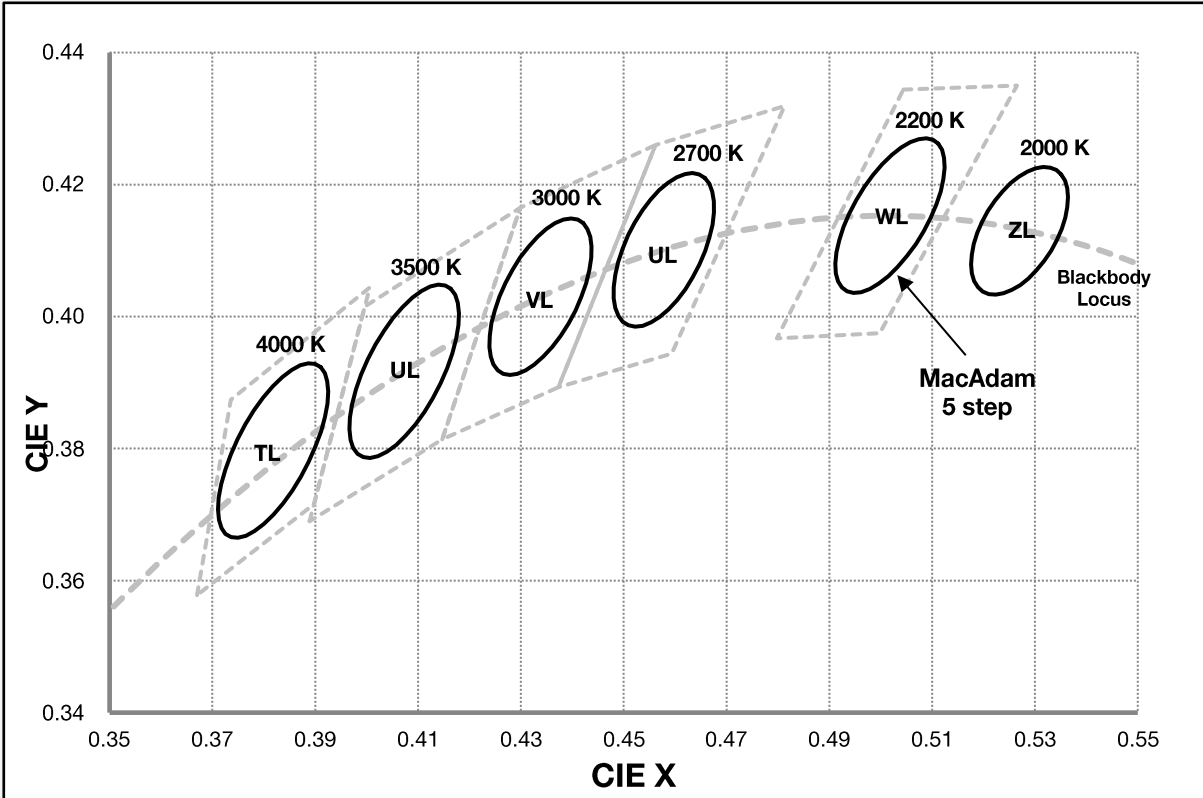

d) Chromaticity Region & Coordinates ( $I_F = 150 \text{ mA}$ ,  $T_s = 85 \text{ }^\circ\text{C}$ ) : "U" (Single bin for MacAdam 3-step)



d) Chromaticity Region & Coordinates ( $I_F = 150 \text{ mA}$ ,  $T_s = 85 \text{ }^\circ\text{C}$ )

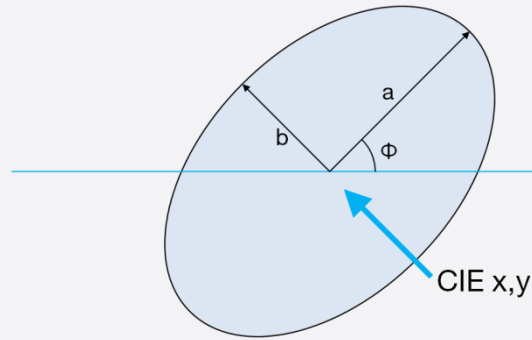

|                    | CCT (K) | Center point |        | Major-axis | Minor-axis | Rotation |
|--------------------|---------|--------------|--------|------------|------------|----------|
|                    |         | CIE x        | CIE y  | a          | b          | $\Phi$   |
| 3 step<br>(U code) | 2000    | 0.5270       | 0.4130 | 0.0072     | 0.0040     | 46.44    |
|                    | 2200    | 0.5018       | 0.4153 | 0.0086     | 0.0040     | 49.27    |
|                    | 2700    | 0.4578       | 0.4101 | 0.0081     | 0.0042     | 53.70    |
|                    | 3000    | 0.4338       | 0.4030 | 0.0083     | 0.0041     | 53.22    |
|                    | 3500    | 0.4073       | 0.3917 | 0.0093     | 0.0041     | 54.00    |
|                    | 4000    | 0.3818       | 0.3797 | 0.0094     | 0.0040     | 53.72    |
|                    | 5000    | 0.3447       | 0.3553 | 0.0082     | 0.0035     | 59.62    |
|                    | 5700    | 0.3287       | 0.3417 | 0.0075     | 0.0032     | 59.10    |
|                    | 6500    | 0.3123       | 0.3282 | 0.0067     | 0.0029     | 58.57    |
| 5 step<br>(L code) | 2000    | 0.5270       | 0.4130 | 0.0118     | 0.0066     | 46.44    |
|                    | 2200    | 0.5018       | 0.4153 | 0.0144     | 0.0066     | 49.27    |
|                    | 2700    | 0.4578       | 0.4101 | 0.0135     | 0.0070     | 53.70    |
|                    | 3000    | 0.4338       | 0.4030 | 0.0138     | 0.0068     | 53.22    |
|                    | 3500    | 0.4073       | 0.3917 | 0.0155     | 0.0068     | 54.00    |
|                    | 4000    | 0.3818       | 0.3797 | 0.0157     | 0.0067     | 53.72    |
|                    | 5000    | 0.3447       | 0.3553 | 0.0137     | 0.0058     | 59.62    |
|                    | 5700    | 0.3287       | 0.3417 | 0.0125     | 0.0053     | 59.10    |
|                    | 6500    | 0.3123       | 0.3282 | 0.0112     | 0.0048     | 58.57    |

**Note:** Samsung maintains measurement tolerance of:  $C_x, C_y = \pm 0.005$

### 3. Typical Characteristics Graphs

#### a) Spectrum Distribution ( $I_f = 150 \text{ mA}$ , $T_s = 85 \text{ }^\circ\text{C}$ )

CCT: 2700 K, CRI80

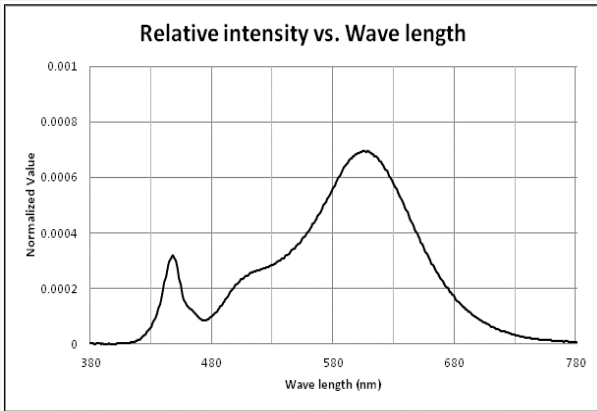

CCT: 5000 K, CRI80

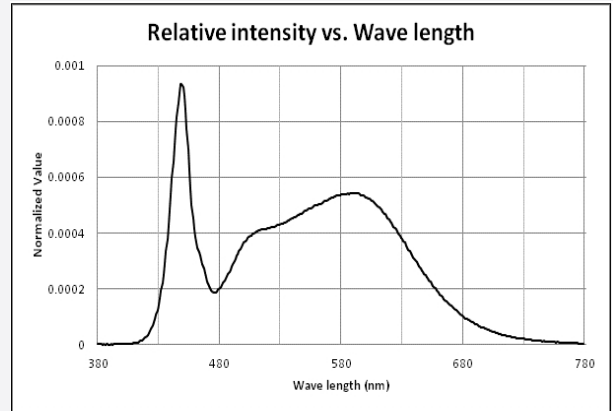

#### b) Forward Current Characteristics ( $T_s = 85 \text{ }^\circ\text{C}$ )

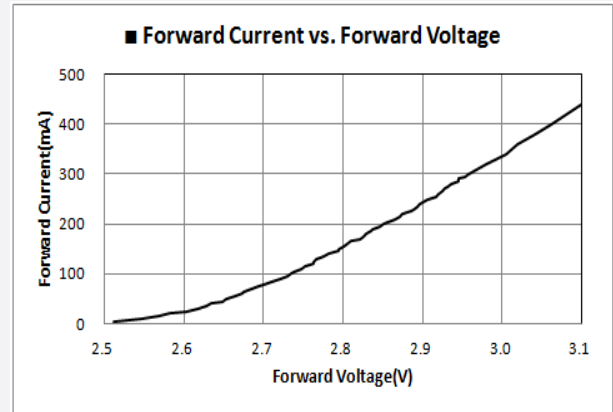
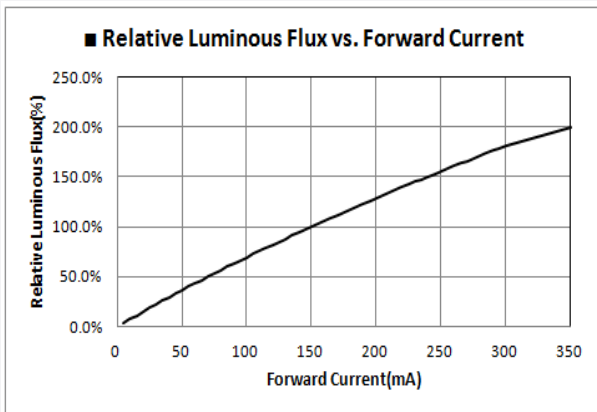

#### c) Temperature Characteristics ( $I_f = 150 \text{ mA}$ )

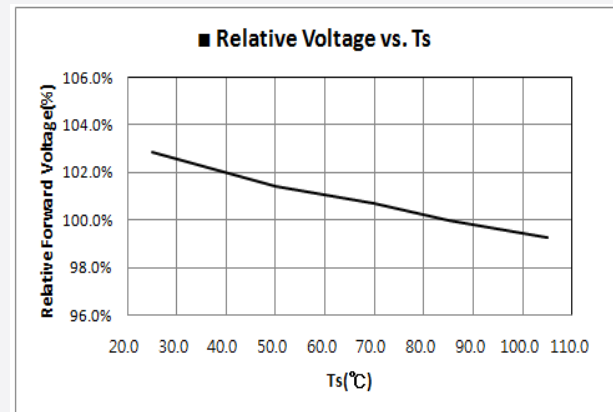
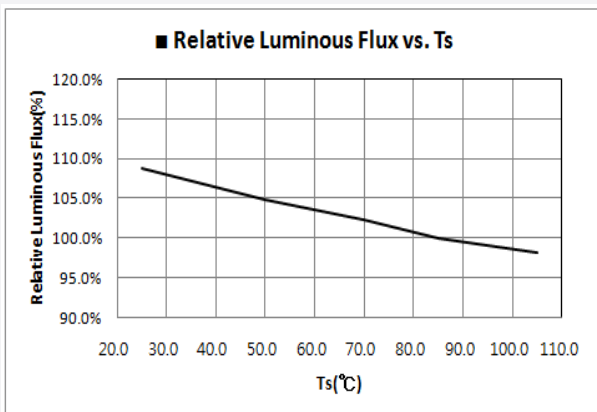

d) Color Shift Characteristics ( $T_s = 85^\circ\text{C}$ ,  $I_f = 150\text{ mA}$ )

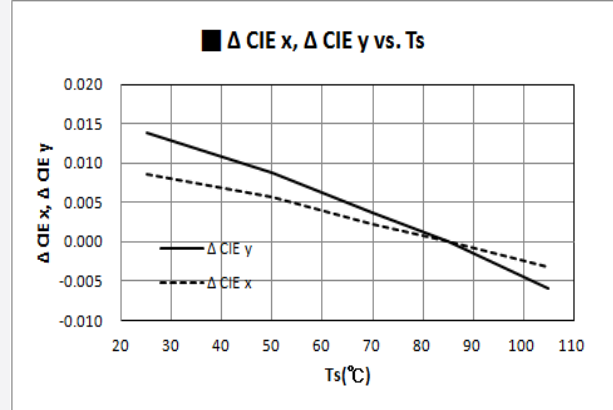
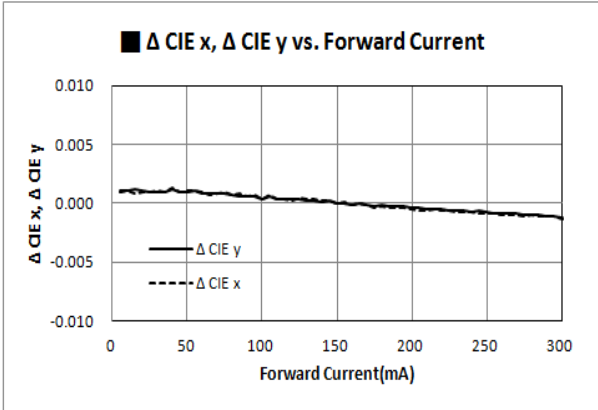

e) Derating Curve

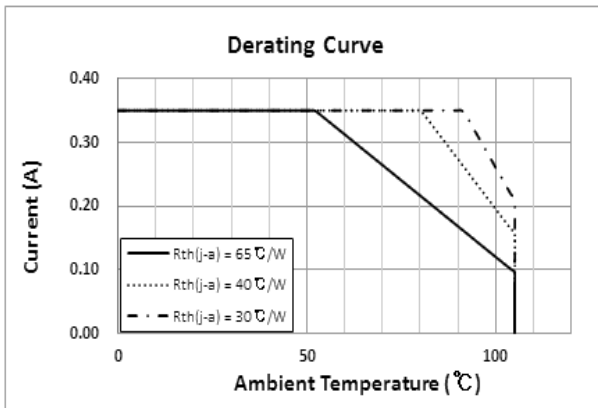

$R_{th}$  is measured after soldering of LED chip on the metal based substrate.  
 \*metal: aluminum (refer to page 17)

f) Beam Angle Characteristics ( $I_f = 150\text{ mA}$ )

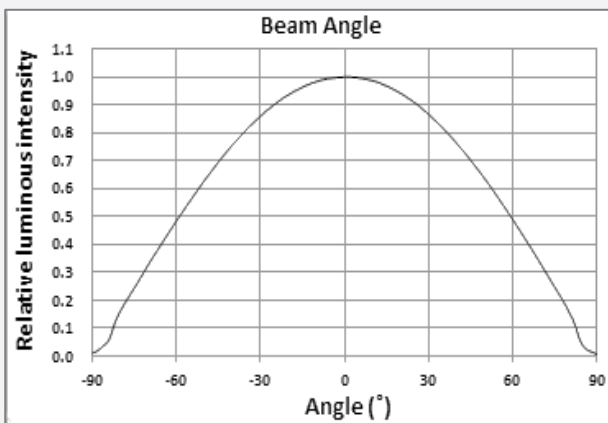

## 4. Outline Drawing & Dimension

1. Tolerance is  $\pm 0.10$  mm
2. Do not place LEDs with pressure

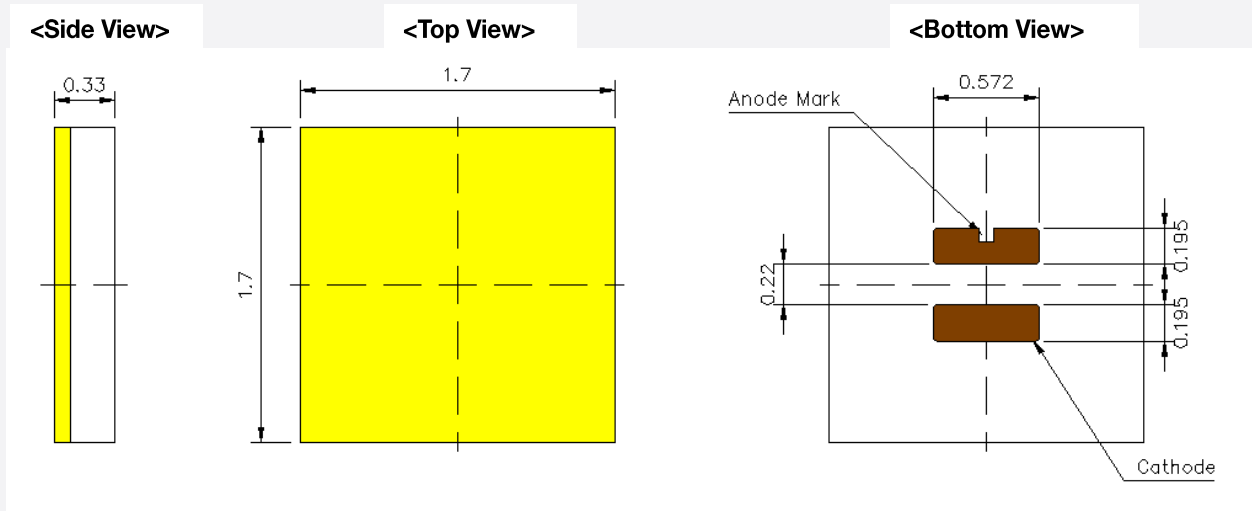

- Measurement unit: mm
- Tolerance:  $\pm 0.10$  mm

### Precautions:

- 1) Pressure on the LEDs will influence to the reliability of the LEDs. Precautions should be taken to avoid strong pressure on the LEDs. Do not put stress on the LEDs during heating.
- 2) Re-soldering should not be done after the LEDs have been soldered. If re-soldering is unavoidable, LED's characteristics should be carefully checked before and after such repair.
- 3) Do not stack assembled PCBs together. Since materials of LEDs is soft, abrasion between two PCB assembled with LED might cause catastrophic failure of the LEDs.

**T<sub>s</sub> Point & Measurement Method:**

Measure nearest point from the center of LED chip ( $\delta$ ) as shown below.

Distance between chip center and T<sub>s</sub> point ( $\delta$ ) = 3.5 mm

$T_j = T_s + \text{Power} \times \text{Thermal resistance at } T_s (R_{j-s})$

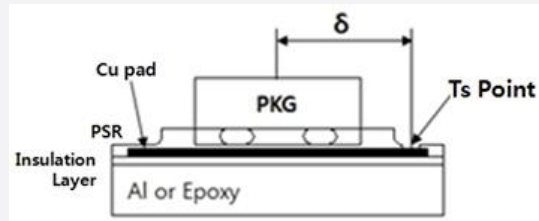
**Precautions:**

- 4) This LED chip PKG does not contain built-in ESD protection device.
- 5) Pressure on the LEDs will influence to the reliability of the LEDs. Precautions should be taken to avoid strong pressure on the LEDs. Do not put stress on the LEDs during heating.
- 6) Re-soldering should not be done after the LEDs have been soldered. If re-soldering is unavoidable, LED's characteristics should be carefully checked before and after such repair.
- 7) Do not stack assembled PCBs together. Since materials of LEDs is soft, abrasion between two PCB assembled with LED might cause catastrophic failure of the LEDs

## 5. Reliability Test Items & Conditions

### a) Test Items

| Test Item                           | Test Condition   | Test Hour / Cycle |
|-------------------------------------|--|-------------------|
| Room Temperature Life Test          | 25 °C, Derated max current   | 1000 h            |
| High Temperature Life Test          | 85 °C, Derated max current   | 1000 h            |
| High Temperature Humidity Life Test | 85 °C, 85 % RH, Derated max current  | 1000 h            |
| Low Temperature Life Test           | -40 °C, DC Derated max current   | 1000 h            |
| Powered Temperature Cycle Test      | -45 °C / 20 min ↔ 85 °C / 20 min, sweep<br>100 min cycle on/off: each 5 min, Derated max current   | 100 cycles        |
| Temperature Cycling                 | -45 °C / 15 min ↔ 125 °C / 15 min<br>→ Hot plate 180 °C  | 500 cycles        |
| High Temperature Storage            | 120 °C   | 1000 h            |
| Low Temperature Storage             | -40 °C   | 1000 h            |
| ESD (HBM)                           |  <p>           R<sub>1</sub>: 10 MΩ<br/>           R<sub>2</sub>: 1.5 kΩ<br/>           C: 100 pF<br/>           V: ±2 kV         </p> | 5 times           |
| Vibration Test                      | 20~2000~20 Hz, 200 m/s <sup>2</sup> , sweep 4 min<br>X, Y, Z 3 direction, each 1 cycle   | 4 cycles          |
| Mechanical Shock Test               | 1500 g, 0.5 ms   | 5 cycles          |

### b) Criteria for Judging the Damage

| Item            | Symbol         | Test Condition<br>(T <sub>s</sub> = 25 °C) | Limit             |                   |
|-----------------|----------------|--|-------------------|-------------------|
|                 |                |  | Min               | Max               |
| Forward Voltage | V <sub>F</sub> | I <sub>F</sub> = Derated max current       | Init. Value * 0.9 | Init. Value * 1.1 |
| Luminous Flux   | Φ <sub>v</sub> | I <sub>F</sub> = Derated max current       | Init. Value * 0.7 | Init. Value * 1.1 |

## 6. Soldering Conditions

### a) Reflow Conditions (Pb free)

Reflow frequency: 2 times max.

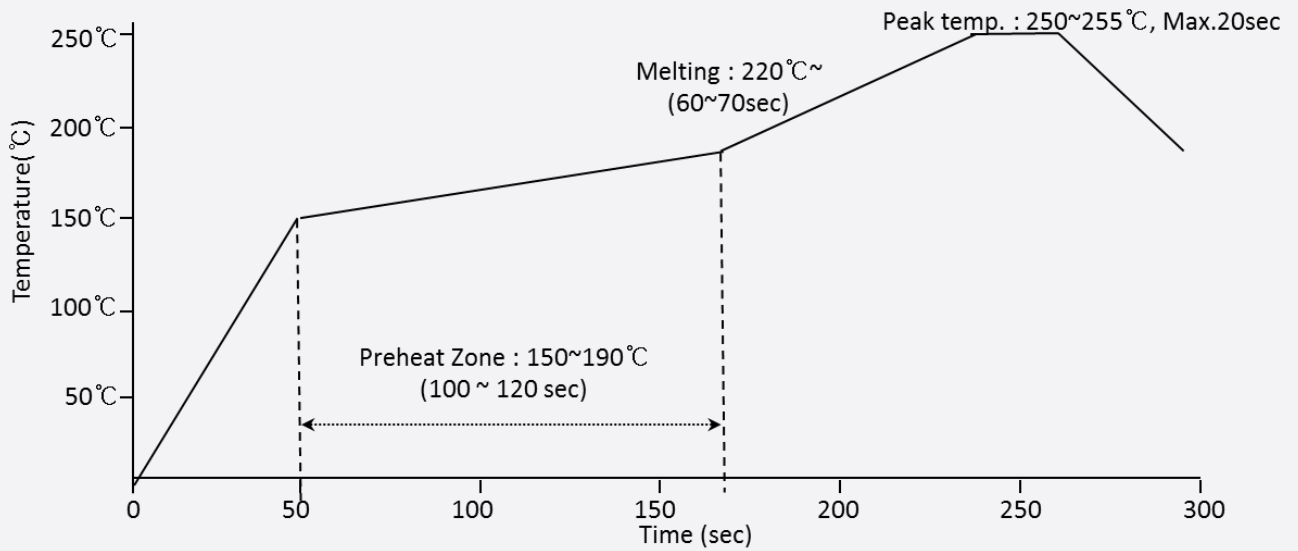

### b) Manual Soldering Conditions

Not more than 5 seconds @ max. 300 °C, under soldering iron



**b) Reel Dimension**

(unit: mm)

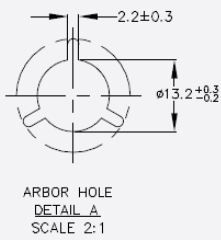
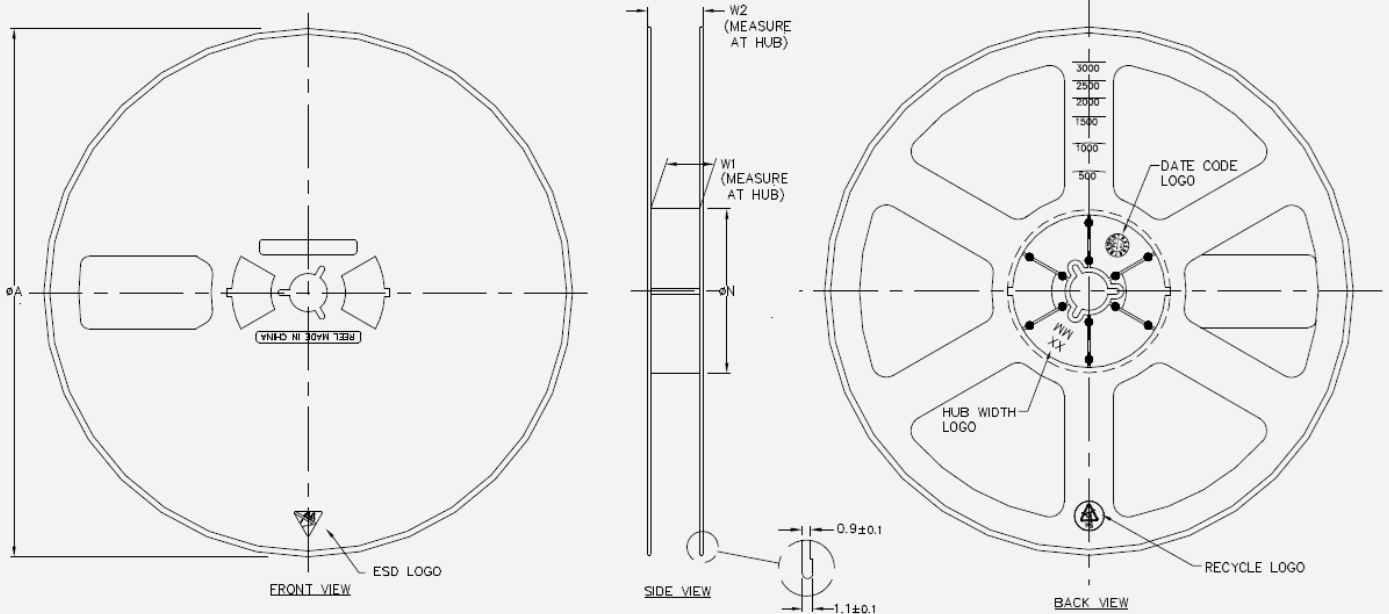

| PRODUCT SPECIFICATIONS |                       |                       |                   |               |
|------------------------|-----------------------|-----------------------|-------------------|---------------|
| TAPE WIDTH             | $\phi A$<br>$\pm 1.0$ | $\phi N$<br>$\pm 0.5$ | $W1$<br>$\pm 0.5$ | $W2$<br>(MAX) |
| 08MM                   | $\phi 178.0$          | 54.0                  | 9.5               | 15.0          |
| 12MM                   | $\phi 178.0$          | 54.0                  | 13.5              | 19.0          |

**Notes:**

- 1) Quantity: 4,000 Qty/reel
- 2) Cumulative tolerance: Cumulative tolerance / 10 pitches is  $\pm 0.2$  mm
- 3) Packaging: P/N, Manufacturing data code no. and quantity are indicated on the aluminum packing bag

## 8. Label Structure

### a) Label Structure

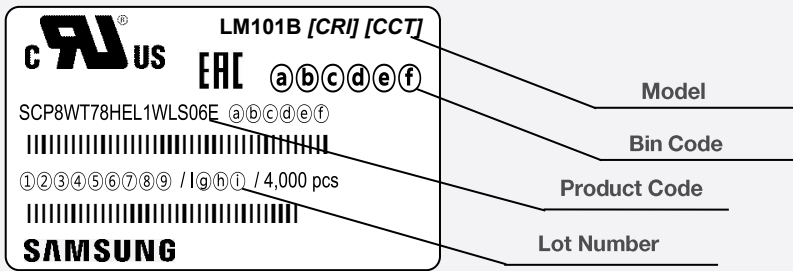

Note: Denoted product code and bin code above is only an example

Bin Code:

- ⓐⓑ: Chromaticity bin (refer to page 10-14)
- ⓒⓓ: Luminous Flux bin (refer to page 7-9)
- ⓔⓕ: Forward Voltage bin (refer to page 11)

### b) Lot Number

The lot number is composed of the following characters:



①②③④⑤⑥⑦⑧⑨ / I a b c / 4,000 pcs

- ① ② : Production site (GB: Nanchang China)
- ③ : Product state (A: Normal, B: Bulk, C: First Production, R: Reproduction, S: Sample)
- ④ : Year (Z: 2015, A: 2016, ..., E: 2020, ...)
- ⑤ : Month (1~9, A, B, C)
- ⑥ : Day (1~9, A, B~V)
- ⑦⑧⑨ : Product serial number (001 ~ 999)
- ⑨ h ⑩ : Reel number (001 ~ 999) or (AAA ~ ZZZ)

## 9. Packing Structure

### a) Packing Process

Reel

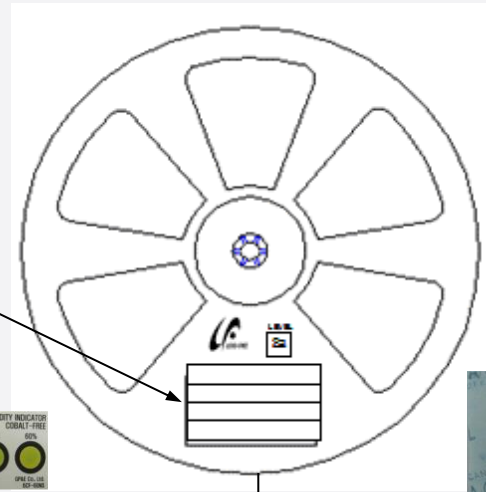
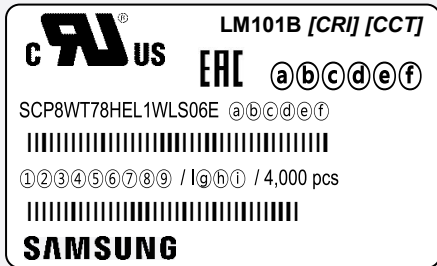

Aluminum Vinyl Bag



Outer Box

Material: Paper (SW3B(A))

| Type   | Size (mm) |         |         | Note         |
|--------|-----------|---------|---------|--------------|
|        | L         | W       | H       |              |
| 7 inch | 295 ± 5   | 290 ± 5 | 260 ± 5 | Max 10 reels |

① Side Label

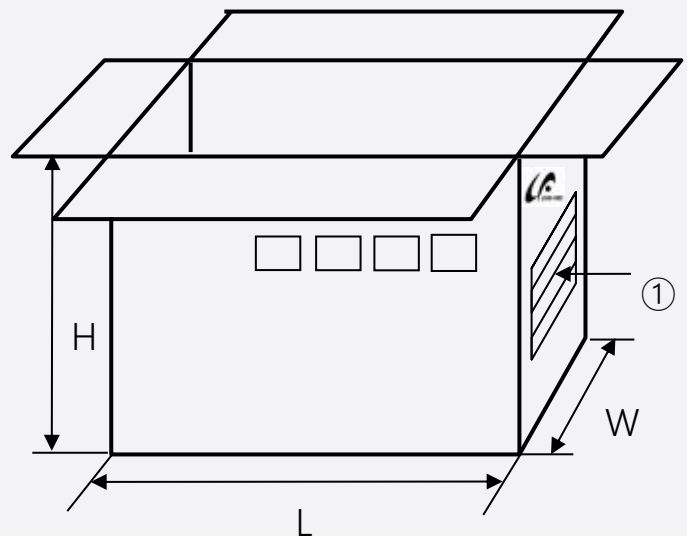
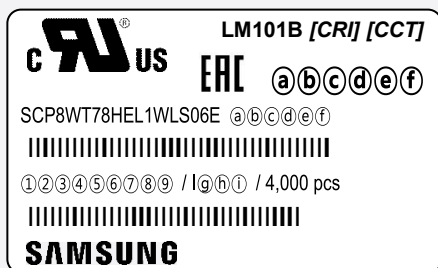

b) Aluminum Vinyl Packing Bag



**CAUTION**

This bag contains  
**MOISTURE SENSITIVE DEVICES**

LEVEL  
**2a**

1. Shelf life in sealed bag: 12 months at <40°C and <90% relative humidity (RH)
2. Peak package body temperature: 240 °C
3. After this bag is opened, devices that will be subjected to reflow solder or other high temperature processes must be:
  - a. Mounted within 672 hours at factory conditions of equal to or less than 30°C /60% RH, or
  - b. Stored at <10% RH
4. Devices require bake, before mounting, if:
  - a. Humidity Indicator Card is >65% when read at 23±5°C, or
  - b. 2a is not met.
5. If baking is required, devices must be baked for 1 hours at 60±5°C

Note: If device containers cannot be subjected to high temperature or shorter bake times are desired, reference IPC/JEDEC J-STD-033 for bake procedure.

Bag seal due date: \_\_\_\_\_

(If blank, see code label)

Note: Level and body temperature by IPC/JEDEC J-STD-020



LM101B [CRI] [CCT]

ERC (a)(b)(c)(d)(e)(f)

SCP8WT78HEL1WLS06E (a)(b)(c)(d)(e)(f)

①②③④⑤⑥⑦⑧⑨ / I@h① / 4,000 pcs

**SAMSUNG**





**ATTENTION**

OBSEVE PRECAUTIONS  
FOR HANDLING  
ELECTROSTATIC  
SENSITIVE  
DEVICES



**주의 사항**

이 알루미늄 지퍼 팩은 습기 및 정전기로부터 제품을 보호하기 위하여 제작되었습니다. 개봉 후에는 즉시 솔더 작업을 실시하는 것을 권장합니다.

습기 및 정전기로부터 제품을 보호 하기 위해서 개봉 후 사용하지 않는 자재는 본 팩에 넣어 보관 하시기 바랍니다. 사용하지 않는 자재를 본 팩에 넣을 때는 반드시 동봉된 드라이 팩과 함께 넣고 지퍼부분을 완전하게 밀봉하여 주시기 바랍니다.

**Important**

This Al Zipper bag is designed to protect the enclosed products from moisture and ESD. Once opened, the products should be soldered onto the printed circuit board immediately. When not in use, please do not leave the products unprotected by the Al Zipper Bag. To repack unused products., please ensure the zip-lock is completely sealed with the dry pack left inside.

c) Silica Gel & Humidity Indicator Card inside Aluminum Vinyl Bag

**HUMIDITY INDICATOR**

Cobalt-Free

|     |     |     |     |     |     |
|-----|-----|-----|-----|-----|-----|
| 10% | 20% | 30% | 40% | 50% | 60% |
|     |     |     |     |     |     |

T-PC-D

DANGER IF AZURE, CHANGE DESICCANT

Read at Lavender & Brown

**SAMSUNG**

## 10. Precautions in Handling & Use

- 1) For over-current-proof function, customers are recommended to apply resistors to prevent sudden change of the current caused by slight shift of the voltage.
- 2) This device should not be used in any type of fluid such as water, oil, organic solvent, etc. When washing is required, IPA is recommended to use.
- 3) When the LEDs illuminate, operating current should be decided after considering the ambient maximum temperature.
- 4) LEDs must be stored in a clean environment. Shelf life of sealed bags: 12 months, temperature ~40 °C, ~90 % RH.
- 5) After storage bag is opened, device subjected to soldering, solder reflow, or other high temperature processes must be:
  - a. Mounted within 672 hours (28 days) at an assembly line with a condition of no more than 30 °C / 60 % RH, or
  - b. Stored at <10 % RH
- 6) Repack unused products with anti-moisture packing, fold to close any opening and then store in a dry place.
- 7) Devices require baking before mounting, if humidity card reading is >60 % at 23 ± 5 °C.
- 8) Devices must be baked for 1 hour at 60 ± 5 °C, if baking is required.
- 9) The LEDs are sensitive to the static electricity and surge. It is recommended to use a wrist band or anti-electrostatic glove when handling the LEDs. If voltage exceeding the absolute maximum rating is applied to LEDs, it may cause damage or even destruction to LED devices. Damaged LEDs may show some unusual characteristics such as increase in leak current, lowered turn-on voltage, or abnormal lighting of LEDs at low current.
- 10) VoCs (Volatile Organic Compounds) can be generated from adhesives, flux, hardener or organic additives used in luminaires (fixtures). LED silicone encapsulant is permeable to those chemicals and they may lead to a discoloration of encapsulant when they exposed to heat or light. This phenomenon can cause a significant loss of light emitted (output) from the luminaires. In order to prevent these problems, we recommend users to know the physical properties of materials used in luminaires and they must be carefully selected.
- 11) Risk of sulfurization (or tarnishing)

The LED from Samsung does not use a silver-plated lead frame but if the LED is attached in silver-plated substrate, the surface color of substrate may change to black (or dark colored) when it is exposed to sulfur (S), chlorine (Cl) or other halogen compound. Sulfurization of substrate may cause intensity degradation, change of chromaticity coordinates and, in extreme cases, open circuit. It requires caution. Due to possible sulfurization of substrate, LED should not be used and stored together with oxidizing substances made of materials such as rubber, plain paper, lead solder cream, etc.

# Legal and additional information.

## [About Samsung Electronics Co., Ltd.](#)

Samsung inspires the world and shapes the future with transformative ideas and technologies.

The company is redefining the worlds of TVs, smartphones, wearable devices, tablets, digital appliances, network systems, and memory, system LSI, foundry and LED solutions. For the latest news, please visit the Samsung Newsroom at [news.samsung.com](https://news.samsung.com).

US\$216.7 billion. To discover more, please visit [www.samsungled.com](https://www.samsungled.com).

Copyright © 2020 Samsung Electronics Co., Ltd. All rights reserved.

Samsung is a registered trademark of Samsung Electronics Co., Ltd.

Specifications and designs are subject to change without notice. Non-metric weights and measurements are approximate. All data were deemed correct at time of creation. Samsung is not liable for errors or omissions. All brand, product, service names and logos are trademarks and/or registered trademarks of their respective owners and are hereby recognized and acknowledged.

Samsung Electronics Co., Ltd.

95, Samsung 2-ro

Giheung-gu

Yongin-si, Gyeonggi-do, 446-711

KOREA

[www.samsungled.com](https://www.samsungled.com)

**SAMSUNG**

## Looking for pricing, stock, or lifecycle information?

Click below to explore more details on WIN SOURCE:

- ⊖ [View SCP7QT78HEL1QUS06E on WIN SOURCE](#)
- ⊖ [Samsung Information](#)

## Optimize Your Supply Chain with WIN SOURCE Solutions

- ✓ Global Sourcing Solution
- ✓ Obsolete Management
- ✓ Cost Control Management
- ✓ Shortage Management
- ✓ Alternative Solution
- ✓ Excess Inventory Management