



**THE DATASHEET OF
SCS7PT93HPL2PUS03F**



Middle Power LED Series Flip Chip Package

LM102A



LM102A opens up a new world of lighting design with its high output and small form factors

Features & Benefits

- Greater freedom of design with compact package size
- High degree of reliability with plastic-free structure
- Low thermal resistance
- High efficiency providing optimized solution
- Compact footprint (1.30 x 1.30 mm)

Applications

Indoor Lighting:

- Downlight
- LED Bulbs
- LED Tubes
- MR / PAR
- Ambient Light
- Ceiling Light

Table of Contents

1.	Characteristics	-----	3
2.	Product Code Information	-----	6
3.	Typical Characteristics Graphs	-----	15
4.	Outline Drawing & Dimension	-----	17
5.	Reliability Test Items & Conditions	-----	19
6.	Soldering Conditions	-----	20
7.	Tape & Reel	-----	21
8.	Label Structure	-----	23
9.	Packing Structure	-----	24
10.	Precautions in Handling & Use	-----	26

1. Characteristics

a) Absolute Maximum Rating

Item	Symbol	Rating	Unit	Condition
Operating Temperature	T_a	-40 ~ +85	°C	-
Storage Temperature	T_{stg}	-40 ~ +120	°C	-
LED Junction Temperature	T_j	125	°C	-
Forward Current	I_F	250	mA	-
Assembly Process Temperature	-	260 <10	°C s	-
ESD (HBM)	-	±2	kV	-

b) Electro-optical Characteristics ($I_F = 150 \text{ mA}$, $T_s = 85 \text{ °C}$)

Item	Unit	Rank	Bin	Min.	Typ.	Max.
Forward Voltage (V_F)	V	3F	-	-	5.89	-
Reverse Voltage (@ $-10 \mu\text{A}$)	V			-10.0	-	-
Color Rendering Index (R_a)	-	8		80	-	-
Special CRI (R9)	-			0	-	-
Thermal Resistance (junction to chip point)	K/W			-	2	-
Beam Angle	°			-	145	-

Note:

Samsung maintains measurement tolerance of: forward voltage = $\pm 0.1 \text{ V}$, luminous flux = $\pm 5 \%$, CRI = ± 3 , R9 = ± 6.5

c) Luminous Flux Characteristics ($I_F = 150 \text{ mA}$, $T_s = 85 \text{ }^\circ\text{C}$)

Item	CRI	Nominal CCT (K)	SA		SB		SC		SD		SE		SF	
			Min.	Max.	Min.	Max.	Min.	Max.	Min.	Max.	Min.	Max.	Min.	Max.
			79	87	87	95	95	103	103	111	111	119	119	127
Luminous Flux (Φ_v)	70	3000												
		3500												
		4000												
		5000												
		5700												
		6500												
	80	2700												
		3000												
		3500												
		4000												
		5000												
		5700												
	90	6500												
		2700												
		3000												
			3500											

Note:

- 1) The LM102A is tested in pulsed condition at rated test current (10 ms pulse width)
- 2) Samsung maintains measurement tolerance of: luminous flux = $\pm 5 \%$

2. Product Code Information ($I_F = 150 \text{ mA}$, $T_s = 85 \text{ }^\circ\text{C}$)

1	2	3	4	5	6	7	8	9	10	11	12	13	14	15	16	17	18
S	C	S	8	W	T	9	3	H	P	L	2	W	L	S	0	3	F

Digit	PKG Information	Code	Specification
1 2 3	Samsung Chip	SCS	
4	CRI	7 8 9	Min. 70 Min. 80 Min. 90
5	CCT (K)	W V U T R Q P	2700 3000 3500 4000 5000 5700 6500
6	Chip Shape	T	Square
7 8 9	Chip Size (μm)	93H	930x930x170 μm
10 11 12	Product Purpose	PL2	PoC for Lighting
13	CCT (K)	W V U T R Q P	2700K 3000K 3500K 4000K 5000K 5700K 6500K
14	MacAdam Step	L U	Single Bin for MacAdam 5-step L(MacAdam 5-step Bin) Single Bin for MacAdam 3-step U(MacAdam 3-step Bin)
15 16	Luminous Flux (lm)	S0	Bin Code: SA, SB, SC, SD, SE, SF
17 18	Forward Voltage (V)	3F	5.6-6.2 Bin Code: 39 5.6-5.9 9F 5.9-6.2

a) Luminous Flux Bins ($I_F = 150 \text{ mA}$, $T_s = 85 \text{ °C}$)

CRI (R_a) Min.	Nominal CCT (K)	Product Code	Flux Bin	Flux Range (Φ_v, lm)
70	3000	SCS7VT93HPL2V☆S03F	SD	103 ~ 111
			SE	111 ~ 119
	3500	SCS7UT93HPL2U☆S03F	SD	103 ~ 111
			SE	111 ~ 119
	4000	SCS7TT93HPL2T☆S03F	SE	111 ~ 119
			SF	119 ~ 127
	5000	SCS7RT93HPL2R☆S03F	SE	111 ~ 119
			SF	119 ~ 127
	5700	SCS7QT93HPL2Q☆S03F	SE	111 ~ 119
			SF	119 ~ 127
	6500	SCS7PT93HPL2P☆S03F	SE	111 ~ 119
			SF	119 ~ 127

Note: “☆” can be “L” (Single bin for MacAdam 5-step), “U” (Single bin for MacAdam 3-step)

a) Luminous Flux Bins ($I_f = 150 \text{ mA}$, $T_s = 85 \text{ °C}$)

CRI (R_a) Min.	Nominal CCT (K)	Product Code	Flux Bin	Flux Range (Φ_v , lm)
80	2700	SCS8WT93HPL2W☆S03F	SC	95 ~ 103
			SD	103 ~ 111
	3000	SCS8VT93HPL2V☆S03F	SC	95 ~ 103
			SD	103 ~ 111
	3500	SCS8UT93HPL2U☆S03F	SD	103 ~ 111
			SE	111 ~ 119
	4000	SCS8TT93HPL2T☆S03F	SD	103 ~ 111
			SE	111 ~ 119
	5000	SCS8RT93HPL2R☆S03F	SE	111 ~ 119
			SF	119 ~ 127
	5700	SCS8QT93HPL2Q☆S03F	SD	103 ~ 111
			SE	111 ~ 119
	6500	SCS8PT93HPL2P☆S03F	SD	103 ~ 111
			SE	111 ~ 119

Note: “☆” can be “L” (Single bin for MacAdam 5-step), “U” (Single bin for MacAdam 3-step)

a) Luminous Flux Bins ($I_F = 150 \text{ mA}$, $T_s = 85 \text{ °C}$)

CRI (R_a) Min.	Nominal CCT (K)	Product Code	Flux Bin	Flux Range (Φ_v , lm)
90	2700	SCS9WT93HPL2W☆S03F	SA	79 ~ 87
			SB	87 ~ 95
	3000	SCS9VT93HPL2V☆S03F	SA	79 ~ 87
			SB	87 ~ 95
	3500	SCS9UT93HPL2U☆S03F	SA	79 ~ 87
			SB	87 ~ 95

Note: “☆” can be “L” (Single bin for MacAdam 5-step), “U” (Single bin for MacAdam 3-step)

b) Color Bins ($I_F = 150 \text{ mA}$, $T_s = 85 \text{ °C}$)

CRI Min.	Nominal CCT (K)	Product Code	Color Rank	Chromaticity Bins	
70	3000	SCS7VT93HPL2V☆S03F	VL	VL	
			VU	VU	
	3500	SCS7UT93HPL2U☆S03F	UL	UL	
			UU	UU	
	4000	SCS7TT93HPL2T☆S03F	TL	TL	
			TU	TU	
	5000	SCS7RT93HPL2R☆S03F	RL	RL	
			RU	RU	
	5700	SCS7QT93HPL2Q☆S03F	QL	QL	
			QU	QU	
	6500	SCS7PT93HPL2P☆S03F	PL	PL	
			PU	PU	
	80	2700	SCS8WT93HPL2W☆S03F	WL	WL
				WU	WU
3000		SCS8VT93HPL2V☆S03F	VL	VL	
			VU	VU	
3500		SCS8UT93HPL2U☆S03F	UL	UL	
			UU	UU	
4000		SCS8TT93HPL2T☆S03F	TL	TL	
			TU	TU	
5000		SCS8RT93HPL2R☆S03F	RL	RL	
			RU	RU	
5700		SCS8QT93HPL2Q☆S03F	QL	QL	
			QU	QU	
6500		SCS8PT93HPL2P☆S03F	PL	PL	
			PU	PU	
90	2700	SCS8WT93HPL2W☆S03F	WL	WL	
			WU	WU	
	3000	SCS8VT93HPL2V☆S03F	VL	VL	
			VU	VU	
	3500	SCS8UT93HPL2U☆S03F	UL	UL	
			UU	UU	

Note: “☆” can be “L” (Single bin for MacAdam 5-step), “U” (Single bin for MacAdam 3-step)

c) Voltage Bins ($I_F = 150 \text{ mA}$, $T_s = 85 \text{ °C}$)

Nominal CCT /K	CRI Min	Product Code	Voltage Rank	Voltage Bin	Voltage Range /V
			3F	39	5.6 ~ 5.9
				9F	5.9 ~ 6.2

d) Chromaticity Region & Coordinates ($I_F = 150 \text{ mA}$, $T_s = 85 \text{ }^\circ\text{C}$) : "L" (Full bin for MacAdam 5-step)



d) Chromaticity Region & Coordinates ($I_F = 150 \text{ mA}$, $T_s = 85 \text{ }^\circ\text{C}$) : "U" (Single for MacAdam 3-step)

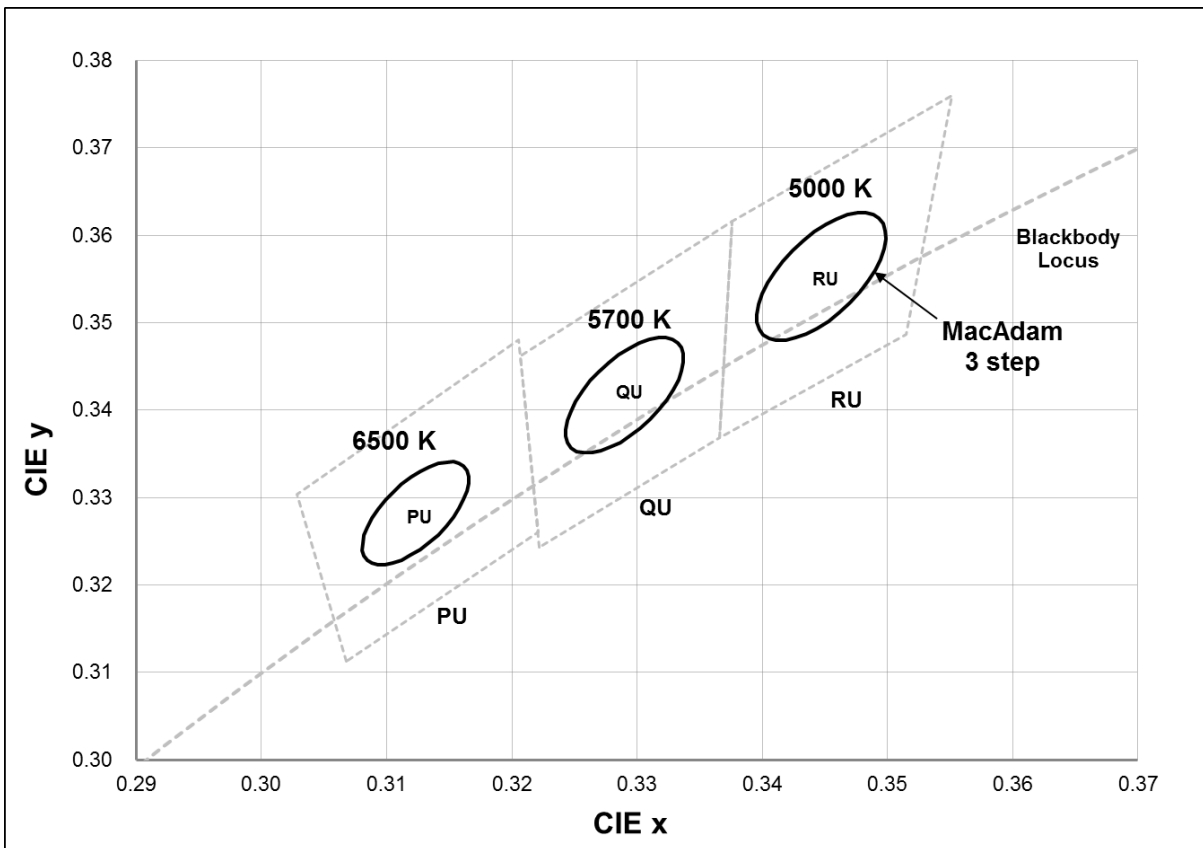
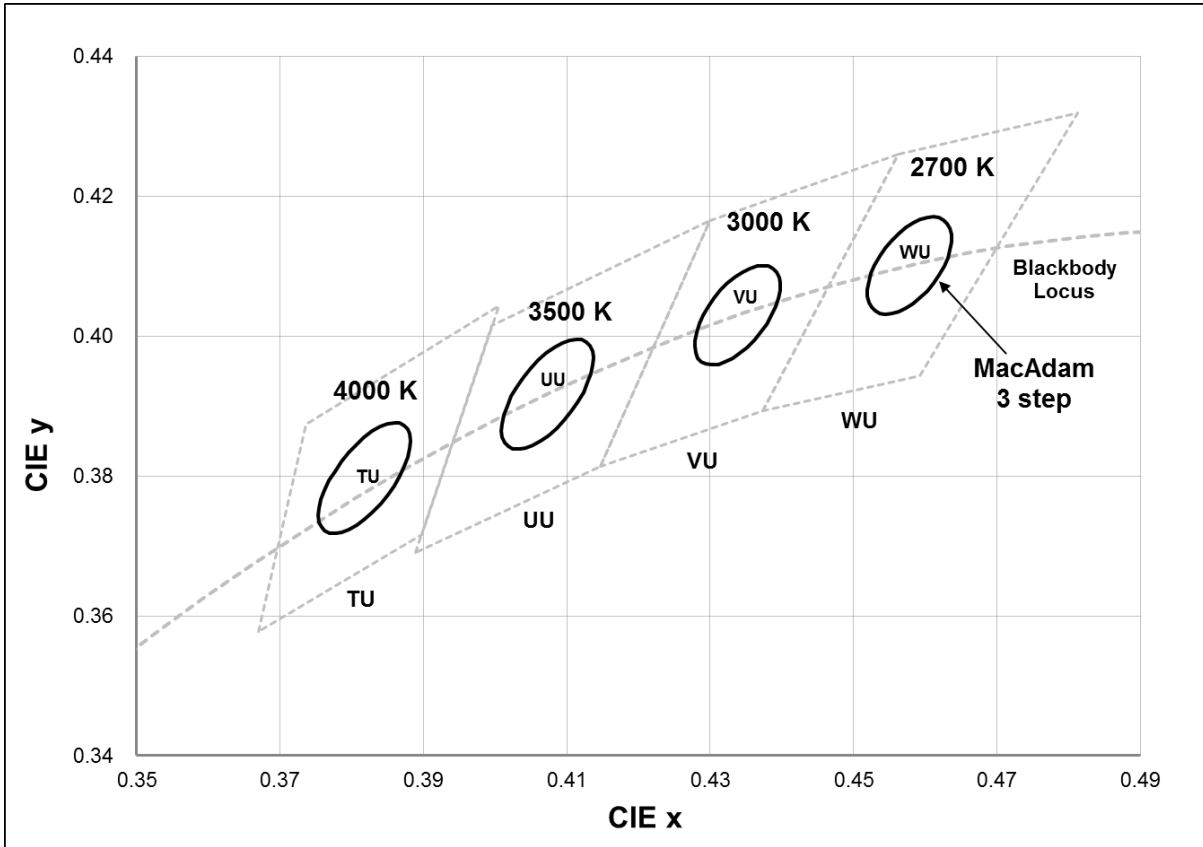

d) Chromaticity Region & Coordinates ($I_F = 150 \text{ mA}$, $T_s = 85 \text{ }^\circ\text{C}$)



	CCT (K)	Center point		Major-axis	Minor-axis	Rotation
		CIE x	CIE y	a	b	ϕ
3 step (U code)	2700	0.4578	0.4101	0.0081	0.0042	53.70
	3000	0.4338	0.4030	0.0083	0.0041	53.22
	3500	0.4073	0.3917	0.0093	0.0041	54.00
	4000	0.3818	0.3797	0.0094	0.0040	53.72
	5000	0.3447	0.3553	0.0082	0.0035	59.62
	5700	0.3287	0.3417	0.0075	0.0032	59.10
	6500	0.3123	0.3282	0.0067	0.0029	58.57
5 step (L code)	2700	0.4578	0.4101	0.0135	0.0070	53.70
	3000	0.4338	0.4030	0.0138	0.0068	53.22
	3500	0.4073	0.3917	0.0155	0.0068	54.00
	4000	0.3818	0.3797	0.0157	0.0067	53.72
	5000	0.3447	0.3553	0.0137	0.0058	59.62
	5700	0.3287	0.3417	0.0125	0.0053	59.10
	6500	0.3123	0.3282	0.0112	0.0048	58.57

Note: Samsung maintains measurement tolerance of: $C_x, C_y = \pm 0.005$

3. Typical Characteristics Graphs

a) Spectrum Distribution ($I_F = 150 \text{ mA}$, $T_s = 25 \text{ }^\circ\text{C}$)

CCT : 2700K

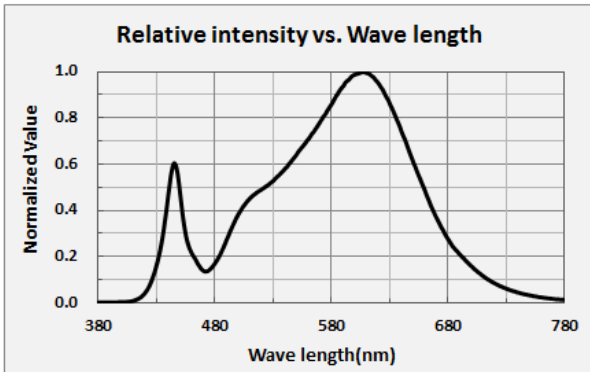

CCT : 5000K



b) Forward Current Characteristics ($T_s = 25 \text{ }^\circ\text{C}$)



c) Temperature Characteristics ($I_F = 150 \text{ mA}$)



d) Color Shift Characteristics

$T_s = 25\text{ }^\circ\text{C}$



$I_F = 150\text{ mA}$



e) Derating Curve

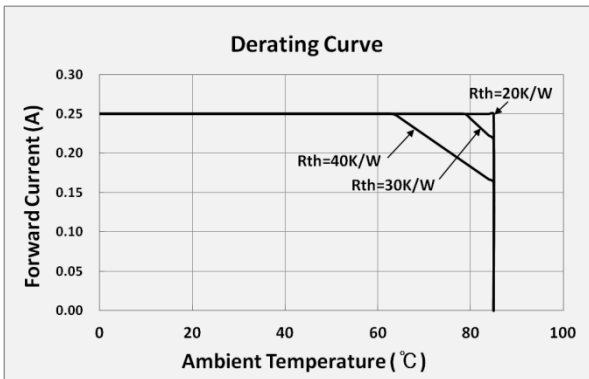

f) Beam Angle Characteristics ($I_F = 150\text{ mA}$)



4. Outline Drawing & Dimension

1. Tolerance is ± 0.10 mm
2. Do not place LEDs with pressure

<Side View>



<Top View>



<Bottom View>



<Recommended Land Pattern>

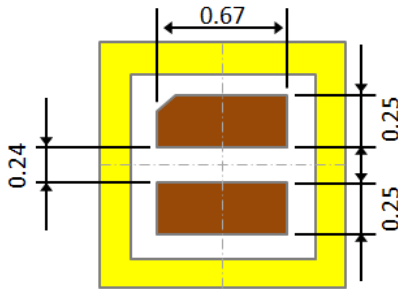

<Chip Pad>

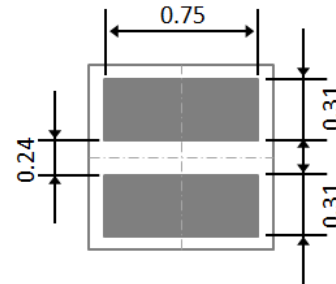

<PCB Land>

T_s Point & Measurement Method:

Measure nearest point from the center of LED chip (δ) as shown below.

Distance between chip center and T_s point (δ) = 3.5 mm

$$T_j = T_s + \text{Power} \times \text{Thermal resistance at } T_s (R_{j-s})$$

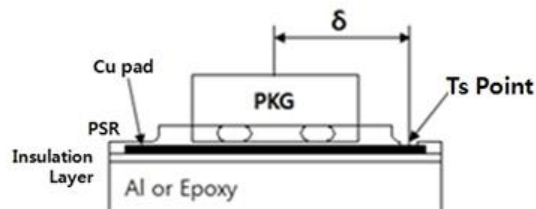

Precautions:

- 1) This LED chip PKG does not contain built-in ESD protection device.
- 2) Pressure on the LEDs will influence to the reliability of the LEDs. Precautions should be taken to avoid strong pressure on the LEDs. Do not put stress on the LEDs during heating.
- 3) Re-soldering should not be done after the LEDs have been soldered. If re-soldering is unavoidable, LED`s characteristics should be carefully checked before and after such repair.
- 4) Do not stack assembled PCBs together. Since materials of LEDs is soft, abrasion between two PCB assembled with LED might cause catastrophic failure of the LEDs.

5. Reliability Test Items & Conditions

a) Test Items

Test Item	Test Condition	Test Hour / Cycle	Sample Size
Room Temperature Life Test	25 °C, DC 250 mA	1000 h	22
High Temperature Life Test	85 °C, DC 250 mA	1000 h	22
High Temperature Humidity Life Test	85 °C, 85 % RH, DC 250 mA	1000 h	22
Low Temperature Life Test	-40 °C, DC 250 mA	1000 h	22
Powered Temperature Cycle Test	-45 °C / 20 min ↔ 85 °C / 20 min, sweep 100 min cycle on/off: each 5 min, DC 250 mA	100 cycles	22
Thermal Shock	-45 °C / 15 min ↔ 125 °C / 15 min → Hot plate 180 °C	800 cycles	100
High Temperature Storage	120 °C	1000 h	11
Low Temperature Storage	-40 °C	1000 h	11
ESD (HBM)	<p> R_1: 10 MΩ R_2: 1.5 kΩ C: 100 pF V: ± 5 kV </p>	5 times	5
Vibration Test	20~2000~20 Hz, 200 m/s ² , sweep 4 min X, Y, Z 3 direction, each 1 cycle	4 cycles	11
Mechanical Shock Test	1500 g, 0.5 ms	5 cycles	11

b) Criteria for Judging the Damage

Item	Symbol	Test Condition ($T_s = 25$ °C)	Limit	
			Min	Max
Forward Voltage	V_F	$I_F = 250$ mA	Init. Value * 0.9	Init. Value * 1.1
Luminous Flux	Φ_v	$I_F = 250$ mA	Init. Value * 0.7	Init. Value * 1.1

6. Soldering Conditions

a) Reflow Conditions (Pb free)

Reflow frequency: 2 times max.



b) Manual Soldering Conditions

Not more than 5 seconds @ max. 300 °C, under soldering iron.

7. Tape & Reel

a) Taping Dimension

(unit: mm)

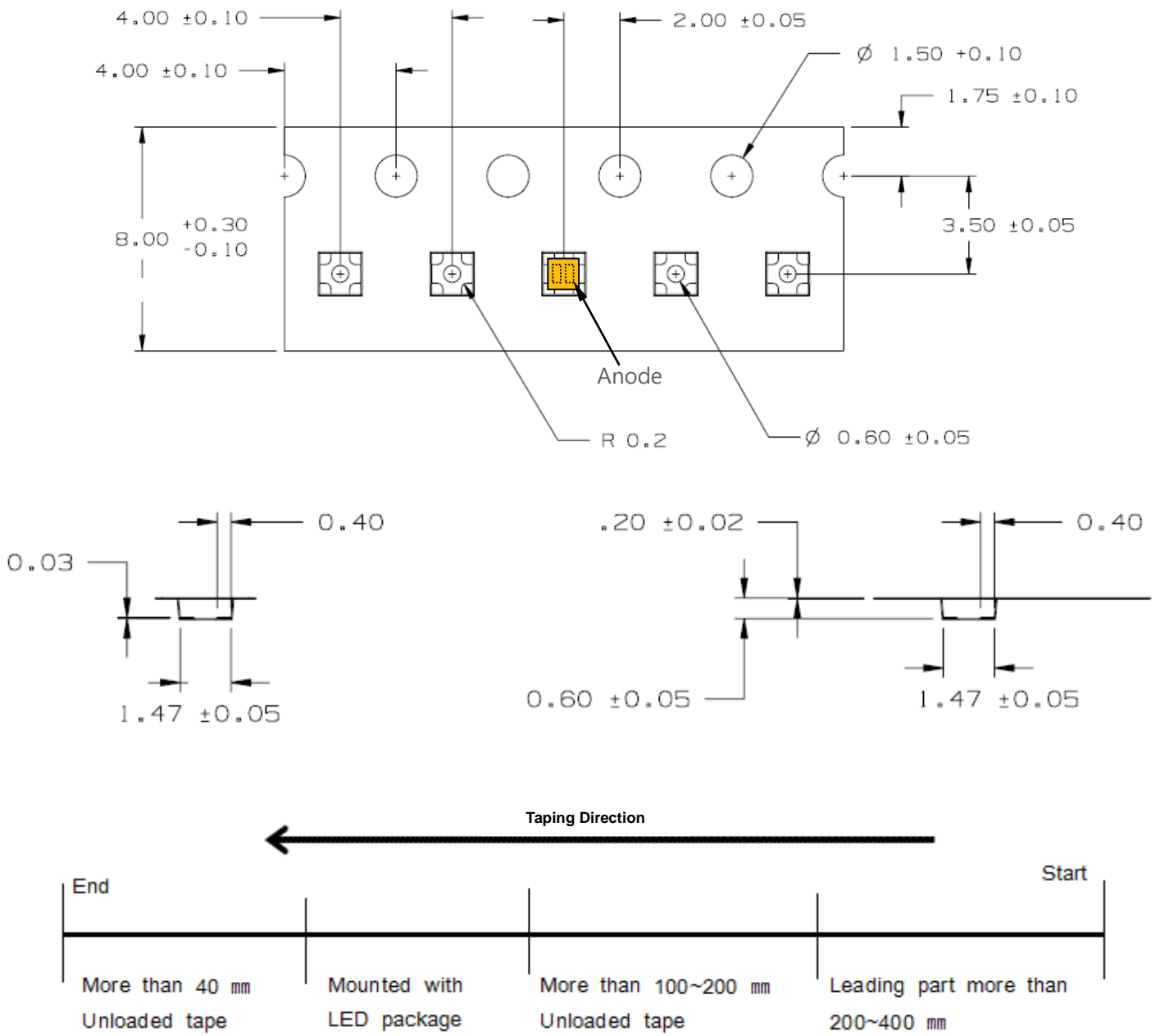

b) Reel Dimension



Width	W1	W2
8mm	9 ±0.3	11.9 ±1.0

Notes:

- 1) Quantity: The quantity/reel is 4,000 pcs
- 2) Cumulative Tolerance: Cumulative tolerance / 10 pitches is ± 0.2 mm
- 3) Packaging: P/N, Manufacturing data code no. and quantity are indicated on the aluminum packing bag

8. Label Structure

a) Label Structure



Note: Denoted product code and bin code above is only an example

Rank Code:

- ⓐⓑ: Chromaticity bin (refer to page 10-11)
- ⓒⓓ: Luminous Flux bin (refer to page 7)
- ⓔⓕ: Forward Voltage bin (refer to page 12)

b) Lot Number

The lot number is composed of the following characters:

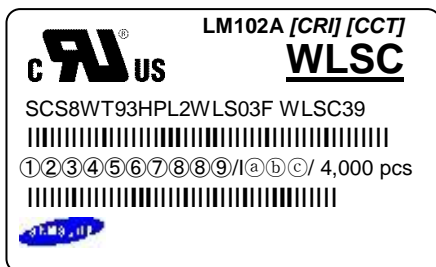

①②③④⑤⑥⑦⑧⑨ / Iⓐⓑⓒ / 4,000 pcs

- ①② : Production site (G3: Shenzhen China, G4: Guangzhou China, GB: Nanchang China)
- ③ : Product state (A: Normal, B: Bulk, C: First Production, R: Reproduction, S: Sample)
- ④ : Year (Y: 2014, Z: 2015, A: 2016 ...)
- ⑤ : Month (1~9, A, B, C)
- ⑥ : Day (1~9, A, B~V)

⑦⑧⑨ : Product serial number (001 ~ 999)

ⒶⒷⒸ : Reel number (001 ~ 999)

9. Packing Structure

a) Packing Process

Reel



Aluminum Vinyl Bag



Outer Box

Material: Paper (SW3B(A))

Type	Size (mm)			Note
	L	W	H	
7 inch	245 ± 5	220 ± 5	86 ± 5	Up to 7 reels max.

① Side Label



b) Aluminum Vinyl Packing Bag



CAUTION

This bag contains
MOISTURE SENSITIVE DEVICES

LEVEL
2a

1. Shelf life in sealed bag: 12 months at <40°C and <90% relative humidity (RH)
2. Peak package body temperature: 240 °C
3. After this bag is opened, devices that will be subjected to reflow solder or other high temperature processes must be:
 - a. Mounted within 672 hours at factory conditions of equal to or less than 30°C /60% RH, or
 - b. Stored at <10% RH
4. Devices require bake, before mounting, if:
 - a. Humidity Indicator Card is > 65% when read at 23±5°C, or
 - b. 2a is not met.
5. If baking is required, devices must be baked for 1 hours at 60±5°C

Note: if device containers cannot be subjected to high temperature or shorter bake times are desired, reference IPC/JEDEC J-STD-033 for bake procedure,

Bag seal due date: _____
(if blank, see code label)

Note: Level and body temperature by IPC/JEDEC J-STD-020



LM102A [CRI] [CCT]
WLSC3F

SCS8WT93HPL2WLS03F WLSC39

①②③④⑤⑥⑦⑧⑨/10/11/12/ 4,000 pcs





ATTENTION

OBSEVE PRECAUTIONS
FOR HANDLING
ELECTROSTATIC
SENSITIVE
DEVICES



■ 주의 사항

이 알루미늄 지퍼 팩은 습기 및 정전기로부터 제품을 보호하기 위하여 제작되었습니다. 개봉 후에는 즉시 솔더 작업을 실시하는 것을 권장합니다.

습기 및 정전기로부터 제품을 보호 하기 위해서 개봉 후 사용하지 않는 자재는 본 팩에 넣어 보관 하시기 바랍니다. 사용하지 않는 자재를 본 팩에 넣을 때는 반드시 동봉된 드라이 팩과 함께 넣고 지퍼부분을 완전하게 밀봉하여 주시기 바랍니다.

■ Important

This Al Zipper bag is designed to protect the enclosed products from moisture and ESD. Once opened, the products should be soldered onto the printed circuit board immediately. When not in use, please do not leave the products unprotected by the Al Zipper Bag. To repack unused products., please ensure the zip-lock is completely sealed with the dry pack left inside.

c) Silica Gel & Humidity Indicator Card inside Aluminum Vinyl Bag

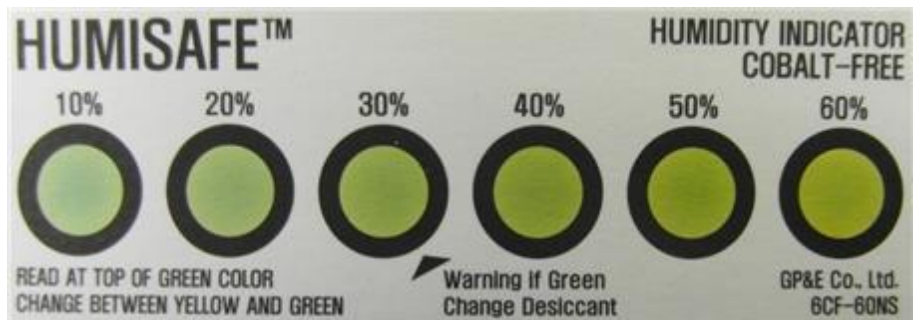

10. Precautions in Handling & Use

- 1) For over-current-proof function, customers are recommended to apply resistors to prevent sudden change of the current caused by slight shift of the voltage.
- 2) This device should not be used in any type of fluid such as water, oil, organic solvent, etc. When washing is required, IPA is recommended to use.
- 3) When the LEDs illuminate, operating current should be decided after considering the ambient maximum temperature.
- 4) LEDs must be stored in a clean environment. If the LEDs are to be stored for three months or more after being shipped from Samsung, they should be packed by a sealed container with nitrogen gas injected (shelf life of sealed bags: 12 months, temperature ~ 40 °C, ~ 90 % RH).
- 5) After storage bag is opened, device subjected to soldering, solder reflow, or other high temperature processes must be:
 - a. Mounted within 672 hours (28 days) at an assembly line with a condition of no more than 30 °C / 60 % RH, or
 - b. Stored at <10 % RH
- 6) Repack unused products with anti-moisture packing, fold to close any opening and then store in a dry place.
- 7) Devices require baking before mounting, if humidity card reading is >65 % at 23 ± 5 °C.
- 8) Devices must be baked for 1 hour at 60 ± 5 °C, if baking is required.
- 9) The LEDs are sensitive to the static electricity and surge. It is recommended to use a wrist band or anti-electrostatic glove when handling the LEDs. If voltage exceeding the absolute maximum rating is applied to LEDs, it may cause damage or even destruction to LED devices. Damaged LEDs may show some unusual characteristics such as increase in leak current, lowered turn-on voltage, or abnormal lighting of LEDs at low current.
- 10) VoCs (Volatile Organic Compounds) can be generated from adhesives, flux, hardener or organic additives used in luminaires (fixtures). LED silicone encapsulant is permeable to those chemicals and they may lead to a discoloration of encapsulant when they exposed to heat or light. This phenomenon can cause a significant loss of light emitted (output) from the luminaires. In order to prevent these problems, we recommend users to know the physical properties of materials used in luminaires and they must be carefully selected.
- 11) Risk of sulfurization (or tarnishing)

The LED from Samsung does not use a silver-plated lead frame but if the LED is attached in silver-plated substrate, the surface color of substrate may change to black (or dark colored) when it is exposed to sulfur (S), chlorine (Cl) or other halogen compound. Sulfurization of substrate may cause intensity degradation, change of chromaticity coordinates and, in extreme cases, open circuit. It requires caution. Due to possible sulfurization of substrate, LED should not be used and stored together with oxidizing substances made of materials such as rubber, plain paper, lead solder cream, etc.

Legal and additional information.

[About Samsung Electronics Co., Ltd.](#)

Samsung Electronics Co., Ltd. is a global leader in technology, opening new possibilities for people everywhere. Through relentless innovation and discovery, we are transforming the worlds of TVs, smartphones, tablets, PCs, cameras, home appliances, printers, LTE systems, medical devices, semiconductors and LED solutions. We employ 286,000 people across 80 countries with annual sales of US\$216.7 billion. To discover more, please visit www.samsungled.com.

Copyright © 2015 Samsung Electronics Co., Ltd. All rights reserved.
Samsung is a registered trademark of Samsung Electronics Co., Ltd.
Specifications and designs are subject to change without notice. Non-metric weights and measurements are approximate. All data were deemed correct at time of creation. Samsung is not liable for errors or omissions. All brand, product, service names and logos are trademarks and/or registered trademarks of their respective owners and are hereby recognized and acknowledged.

Samsung Electronics Co., Ltd.
95, Samsung 2-ro
Giheung-gu
Yongin-si, Gyeonggi-do, 446-711
KOREA

www.samsungled.com



Looking for pricing, stock, or lifecycle information?

Click below to explore more details on WIN SOURCE:

- ⊖ [View SCS7PT93HPL2PUS03F on WIN SOURCE](#)
- ⊖ [Samsung Information](#)

Optimize Your Supply Chain with WIN SOURCE Solutions

- ✓ Global Sourcing Solution
- ✓ Obsolete Management
- ✓ Cost Control Management
- ✓ Shortage Management
- ✓ Alternative Solution
- ✓ Excess Inventory Management