



**THE DATASHEET OF
SPMWH1228FD5WAWMS3**



Middle Power LED Series
2835

LM281B
3V General



Designed for better lm/\$ (Ambient, Linear)

Features & Benefits

- 0.5W Class mid power LED
- Standard form factor for design flexibility (2.8 × 3.5 mm)



Table of Contents

1.	Characteristics	-----	3
2.	Product Code Information	-----	6
3.	Typical Characteristics Graphs	-----	19
4.	Outline Drawing & Dimension	-----	22
5.	Reliability Test Items & Conditions	-----	23
6.	Soldering Conditions	-----	24
7.	Tape & Reel	-----	25
8.	Label Structure	-----	27
9.	Packing Structure	-----	28
10.	Precautions in Handling & Use	-----	31

1. Characteristics

a) Absolute Maximum Rating

Item	Symbol	Rating	Unit	Condition
Ambient / Operating Temperature	T_a	-40 ~ +80	°C	-
Storage Temperature	T_{stg}	-40 ~ +80	°C	-
LED Junction Temperature	T_j	115	°C	-
Forward Current	I_F	160	mA	-
Peak Pulsed Forward Current	I_{FP}	300	mA	Duty 1/10, pulse width 10ms
Assembly Process Temperature	-	260 <10	°C s	-
ESD (HBM)	-	2	kV	-

Note:

Proper current derating must be observed to maintain junction temperature below the maximum at all time.

b) Electro-optical Characteristics ($I_F = 150 \text{ mA}$, $T_s = 25 \text{ }^\circ\text{C}$)

Item	Unit	Rank	Bin	Min.	Typ.	Max.
Forward Voltage (VF)	V	WA	A2	2.9		3.0
			A3	3.0		3.1
			A4	3.1	-	3.2
			A5	3.2	-	3.3
Color Rendering Index (Ra)	-	5		80	-	-
Thermal Resistance (junction to solder point)	$^\circ\text{C/W}$			-	25	-
Beam Angle	$^\circ$			-	120	-

Note:

Samsung maintains measurement tolerance of: forward voltage = $\pm 0.1 \text{ V}$, CRI = ± 3

b) Electro-optical Characteristics (I_F = 150 mA, T_s = 25 °C)

Item	CRI (R _a) Min.	Nominal CCT (K)	Bin	150mA		Calculated value at 65mA	
				Min.	Max.	Min.	Max.
Luminous Flux (Φ _v)	80	2700	S2	53.3	57.3	26.0	28.0
			S3	57.3	61.3	28.0	30.0
			S4	61.3	65.3	30.0	32.0
		3000	S2	54.3	58.3	26.5	28.5
			S3	58.3	62.3	28.5	30.5
			S4	62.3	66.3	30.5	32.5
		3500	S2	55.3	59.3	27.0	29.0
			S3	59.3	63.3	29.0	31.0
			S4	63.3	67.3	31.0	33.0
		4000	S2	57.3	61.3	28.0	30.0
			S3	61.3	65.3	30.0	32.0
			S4	65.3	69.3	32.0	34.0
		5000	S2	59.3	63.3	29.0	31.0
			S3	63.3	67.3	31.0	33.0
			S4	67.3	71.3	33.0	37.0
		5700	S2	58.3	62.3	28.5	30.5
			S3	62.3	66.3	30.5	32.5
			S4	66.3	71.3	32.5	36.5
		6500	S2	57.3	61.3	28.0	30.0
			S3	61.3	65.3	30.0	32.0
			S4	65.3	69.3	32.0	34.0

Note:

Samsung maintains measurement tolerance of: forward voltage = ±0.1V, luminous flux = ±5 %, CRI = ±3

Calculated luminous flux values at 65mA are for reference only.

2. Product Code Information

1	2	3	4	5	6	7	8	9	10	11	12	13	14	15	16	17	18
S	P	M	W	H	1	2	2	8	F	D	5	W	A	R	0	S	0

Digit	PKG Information	Code	Specification				
1 2 3	Samsung Package Middle Power	SPM					
4 5	Color	WH	White				
6	Product Version	1					
7 8 9	Form Factor	228	2.8 x 3.5 x 0.65 mm; 2 pads; 1chip;				
10	Sorting Current (mA)	F	150 mA				
11	Chromaticity Coordinates	D	ANSI Standard				
12	CRI	5	Min. 80				
13 14	Forward Voltage (V)	WA	2.9~3.3	Bin code	A2	2.9 ~ 3.0	
					A3	3.0 ~ 3.1	
					A4	3.1 ~ 3.2	
					A5	3.2 ~ 3.3	
15 16	CCT (K)	W☆ V☆ U☆ T☆ R☆ Q☆ P☆	2700 3000 3500 4000 5000 5700 6500	Bin Code:	W1, W2, W3, W4, W5, W6, W7, W8, W9, WA, WB, WC, WD, WE, WF, WG V1, V2, V3, V4, V5, V6, V7, V8, V9, VA, VB, VC, VD, VE, VF, VG U1, U2, U3, U4, U5, U6, U7, U8, U9, UA, UB, UC, UD, UE, UF, UG T1, T2, T3, T4, T5, T6, T7, T8, T9, TA, TB, TC, TD, TE, TF, TG R1, R2, R3, R4, R5, R6, R7, R8, R9,RA,RB,RC,RD,RE,RF,RG Q1, Q2, Q3, Q4, Q5, Q6, Q7, Q8, Q9,QA,QB,QC,QD,QE,QF,QG P1, P2, P3, P4, P5, P6, P7, P8, P9,PA,PB,PC,PD,PE,PF,PG		
			☆ : "0" (Whole bin) "M" (Quarter bin) or "K" (kitting bin)				
17 18	Luminous Flux	S2 S3 S4	S2 Bin Code S3 S4				

a) Luminous Flux Bins ($I_f = 150 \text{ mA}$, $T_s = 25^\circ\text{C}$)

CRI (R_a) Min.	Nominal CCT (K)	Product Code	Flux Bin	Flux Range (Φ_v , lm)
80	2700	SPMWH1228FD5WAW☆S2	S2	53.3 ~ 57.3
		SPMWH1228FD5WAW☆S3	S3	57.3 ~ 61.3
		SPMWH1228FD5WAW☆S4	S4	61.3 ~ 65.3
	3000	SPMWH1228FD5WAV☆S2	S2	54.3 ~ 58.3
		SPMWH1228FD5WAV☆S3	S3	58.3 ~ 62.3
		SPMWH1228FD5WAV☆S4	S4	62.3 ~ 66.3
	3500	SPMWH1228FD5WAU☆S2	S2	55.3 ~ 59.3
		SPMWH1228FD5WAU☆S3	S3	59.3 ~ 63.3
		SPMWH1228FD5WAU☆S4	S4	63.3 ~ 67.3
	4000	SPMWH1228FD5WAT☆S2	S2	57.3 ~ 61.3
		SPMWH1228FD5WAT☆S3	S3	61.3 ~ 65.3
		SPMWH1228FD5WAT☆S4	S4	65.3 ~ 69.3
	5000	SPMWH1228FD5WAR☆S2	S2	59.3 ~ 63.3
		SPMWH1228FD5WAR☆S3	S3	63.3 ~ 67.3
		SPMWH1228FD5WAR☆S4	S4	67.3 ~ 71.3
	5700	SPMWH1228FD5WAQ☆S2	S2	58.3 ~ 62.3
		SPMWH1228FD5WAQ☆S3	S3	62.3 ~ 66.3
		SPMWH1228FD5WAQ☆S4	S4	66.3 ~ 70.3
	6500	SPMWH1228FD5WAP☆S2	S2	57.3 ~ 61.3
		SPMWH1228FD5WAP☆S3	S3	61.3 ~ 65.3
		SPMWH1228FD5WAP☆S4	S4	65.3 ~ 69.3

Note:

"☆" can be "0" (Whole bin), "M" (Quarter bin) or "K" (Kitting bin) of the color binning

b) Kitting rule

1) Kitting bin Concept

1. Under agreement between customer and SAMSUNG ELECTRONICS, SAMSUNG can supply kitting bin (VF, Color, Im).
2. A forward voltage (VF) of kitting bin is combined by a pair of same VF rank such as (A2+A2), (A3+A3), (A4+A4) or (A5+A5).
3. A Chromaticity Coordinates of kitting bin is mixed by kitting procedure.(below kitting simulation)

[Kitting example]

D Y	E	F	Z G
9	A	B	C
5	6	7	8
W 1	2	3	X 4

[Binning Information]

	Bin #1	Bin #2
VF	A2	A2
	A3	A3
	A4	A4
	A5	A5
CIE	W (1, 2, 5, 6 bin)	Z (B, C, F, G bin)
	V (6, 7, A, B bin)	V (6, 7, A, B bin)
	X (3, 4, 7, 8 bin)	Y (9, A, D, E bin)

※ Each of V, W, X, Y and Z can be one bin without details division

c) Color Bins ($I_F = 150 \text{ mA}$, $T_s = 25 \text{ }^\circ\text{C}$)

CRI (R _a) Min.	Nominal CCT (K)	Product Code	Color Rank	Chromaticity Bins
80	2700	SPMWH1228FD5WAW0S☆	W0 (Whole bin)	W1, W2, W3, W4, W5, W6, W7, W8, W9, WA, WB, WC, WD, WE, WF, WG
		SPMWH1228FD5WAWMS☆	WM (Quarter bin)	W6, W7, WA, WB
		SPMWH1228FD5WAWKS☆	WK (Kitting bin)	WV, WW, WX, WY, WZ
	3000	SPMWH1228FD5WAV0S☆	V0 (Whole bin)	V1, V2, V3, V4, V5, V6, V7, V8, V9, VA, VB, VC, VD, VE, VF, VG
		SPMWH1228FD5WAVMS☆	VM (Quarter bin)	V6, V7, VA, VB
		SPMWH1228FD5WAVKS☆	VK (Kitting bin)	VV, VW, VX, VY, VZ
	3500	SPMWH1228FD5WAU0S☆	U0 (Whole bin)	U1, U2, U3, U4, U5, U6, U7, U8, U9, UA, UB, UC, UD, UE, UF, UG
		SPMWH1228FD5WAUMS☆	UM (Quarter bin)	U6, U7, UA, UB
		SPMWH1228FD5WAUKS☆	UK (Kitting bin)	UV, UW, UX, UY, UZ
	4000	SPMWH1228FD5WAT0S☆	T0 (Whole bin)	T1, T2, T3, T4, T5, T6, T7, T8, T9, TA, TB, TC, TD, TE, TF, TG
		SPMWH1228FD5WATMS☆	TM (Quarter bin)	T6, T7, TA, TB
		SPMWH1228FD5WATKS☆	TK (Kitting bin)	TV, TW, TX, TY, TZ
	5000	SPMWH1228FD5WAR0S☆	R0 (Whole bin)	R1, R2, R3, R4, R5, R6, R7, R8, R9, RA, RB, RC, RD, RE, RF, RG
		SPMWH1228FD5WARMS☆	RM (Quarter bin)	R6, R7, RA, RB
		SPMWH1228FD5WARKS☆	RK (Kitting bin)	RV, RW, RX, RY, RZ
	5700	SPMWH1228FD5WAQ0S☆	Q0 (Whole bin)	Q1, Q2, Q3, Q4, Q5, Q6, Q7, Q8, Q9, QA, QB, QC, QD, QE, QF, QG
		SPMWH1228FD5WAQMS☆	QM (Quarter bin)	Q6, Q7, QA, QB
		SPMWH1228FD5WAQKS☆	QK (Kitting bin)	QV, QW, QX, QY, QZ
	6500	SPMWH1228FD5WAP0S☆	P0 (Whole bin)	P1, P2, P3, P4, P5, P6, P7, P8, P9, PA, PB, PC, PD, PE, PF, PG
		SPMWH1228FD5WAPMS☆	PM (Quarter bin)	P6, P7, PA, PB
		SPMWH1228FD5WAPKS☆	P0 (Kitting bin)	PV, PW, PX, PY, PZ

Note:

"☆" can be "S2", "S3" or "S4" of luminous flux bin

d) Voltage Bins ($I_f = 150 \text{ mA}$, $T_s = 25 \text{ °C}$)

CRI (Ra) Min.	Nominal CCT (K)	Product Code	Voltage Rank	Voltage Bin	Voltage Range (V)
-	-	-	WA	A2	2.9 ~ 3.0
				A3	3.0 ~ 3.1
				A4	3.1 ~ 3.2
				A5	3.2 ~ 3.3

e) Chromaticity Region & Coordinates ($I_F = 150 \text{ mA}$, $T_s = 25 \text{ }^\circ\text{C}$)



e) Chromaticity Region & Coordinates

Region	CIE x	CIE y	Region	CIE x	CIE y
W rank (2700 K)					
W1	0.4373	0.3893	W9	0.4465	0.4071
	0.4418	0.3981		0.4513	0.4164
	0.4475	0.3994		0.4573	0.4178
	0.4428	0.3906		0.4523	0.4085
W2	0.4428	0.3906	WA	0.4523	0.4085
	0.4475	0.3994		0.4573	0.4178
	0.4532	0.4008		0.4634	0.4193
	0.4483	0.3919		0.4582	0.4099
W3	0.4483	0.3919	WB	0.4582	0.4099
	0.4532	0.4008		0.4634	0.4193
	0.4589	0.4021		0.4695	0.4207
	0.4538	0.3931		0.4641	0.4112
W4	0.4538	0.3931	WC	0.4641	0.4112
	0.4589	0.4021		0.4695	0.4207
	0.4646	0.4034		0.4756	0.4221
	0.4593	0.3944		0.4700	0.4126
W5	0.4418	0.3981	WD	0.4513	0.4164
	0.4465	0.4071		0.4562	0.4260
	0.4523	0.4085		0.4624	0.4274
	0.4475	0.3994		0.4573	0.4178
W6	0.4475	0.3994	WE	0.4573	0.4178
	0.4523	0.4085		0.4624	0.4274
	0.4582	0.4099		0.4687	0.4289
	0.4532	0.4008		0.4634	0.4193
W7	0.4532	0.4008	WF	0.4634	0.4193
	0.4582	0.4099		0.4687	0.4289
	0.4641	0.4112		0.4750	0.4304
	0.4589	0.4021		0.4695	0.4207
W8	0.4589	0.4021	WG	0.4695	0.4207
	0.4641	0.4112		0.4750	0.4304
	0.4700	0.4126		0.4813	0.4319
	0.4646	0.4034		0.4756	0.4221

Region	CIE x	CIE y	Region	CIE x	CIE y
V rank (3000 K)					
V1	0.4147	0.3814	V9	0.4221	0.3984
	0.4183	0.3898		0.4259	0.4073
	0.4242	0.3919		0.4322	0.4096
	0.4203	0.3833		0.4281	0.4006
V2	0.4203	0.3833	VA	0.4281	0.4006
	0.4242	0.3919		0.4322	0.4096
	0.4300	0.3939		0.4385	0.4119
	0.4259	0.3853		0.4342	0.4028
V3	0.4259	0.3853	VB	0.4342	0.4028
	0.4300	0.3939		0.4385	0.4119
	0.4359	0.3960		0.4449	0.4141
	0.4316	0.3873		0.4403	0.4049
V4	0.4316	0.3873	VC	0.4403	0.4049
	0.4359	0.3960		0.4449	0.4141
	0.4418	0.3981		0.4513	0.4164
	0.4373	0.3893		0.4465	0.4071
V5	0.4183	0.3898	VD	0.4259	0.4073
	0.4221	0.3984		0.4299	0.4165
	0.4281	0.4006		0.4364	0.4188
	0.4242	0.3919		0.4322	0.4096
V6	0.4242	0.3919	VE	0.4322	0.4096
	0.4281	0.4006		0.4364	0.4188
	0.4342	0.4028		0.4430	0.4212
	0.4300	0.3939		0.4385	0.4119
V7	0.4300	0.3939	VF	0.4385	0.4119
	0.4342	0.4028		0.4430	0.4212
	0.4403	0.4049		0.4496	0.4236
	0.4359	0.3960		0.4449	0.4141
V8	0.4359	0.3960	VG	0.4449	0.4141
	0.4403	0.4049		0.4496	0.4236
	0.4465	0.4071		0.4562	0.4260
	0.4418	0.3981		0.4513	0.4164

e) Chromaticity Region & Coordinates

Region	CIE x	CIE y	Region	CIE x	CIE y
U rank (3500 K)					
U1	0.3889	0.3690	U9	0.3941	0.3848
	0.3915	0.3768		0.3968	0.3930
	0.3981	0.3800		0.4040	0.3966
	0.3953	0.3720		0.4010	0.3882
U2	0.3953	0.3720	UA	0.4010	0.3882
	0.3981	0.3800		0.4040	0.3966
	0.4048	0.3832		0.4113	0.4001
	0.4017	0.3751		0.4080	0.3916
U3	0.4017	0.3751	UB	0.4080	0.3916
	0.4048	0.3832		0.4113	0.4001
	0.4116	0.3865		0.4186	0.4037
	0.4082	0.3782		0.4150	0.3950
U4	0.4082	0.3782	UC	0.4150	0.3950
	0.4116	0.3865		0.4186	0.4037
	0.4183	0.3898		0.4259	0.4073
	0.4147	0.3814		0.4221	0.3984
U5	0.3915	0.3768	UD	0.3968	0.3930
	0.3941	0.3848		0.3996	0.4015
	0.4010	0.3882		0.4071	0.4052
	0.3981	0.3800		0.4040	0.3966
U6	0.3981	0.3800	UE	0.4040	0.3966
	0.4010	0.3882		0.4071	0.4052
	0.4080	0.3916		0.4146	0.4089
	0.4048	0.3832		0.4113	0.4001
U7	0.4048	0.3832	UF	0.4113	0.4001
	0.4080	0.3916		0.4146	0.4089
	0.4150	0.3950		0.4222	0.4127
	0.4116	0.3865		0.4186	0.4037
U8	0.4116	0.3865	UG	0.4186	0.4037
	0.4150	0.3950		0.4222	0.4127
	0.4221	0.3984		0.4299	0.4165
	0.4183	0.3898		0.4259	0.4073

Region	CIE x	CIE y	Region	CIE x	CIE y
T rank (4000 K)					
T1	0.3670	0.3578	T9	0.3702	0.3722
	0.3726	0.3612		0.3763	0.3760
	0.3744	0.3685		0.3782	0.3837
	0.3686	0.3649		0.3719	0.3797
T2	0.3726	0.3612	TA	0.3763	0.3760
	0.3783	0.3646		0.3825	0.3798
	0.3804	0.3721		0.3847	0.3877
	0.3744	0.3685		0.3782	0.3837
T3	0.3783	0.3646	TB	0.3825	0.3798
	0.3840	0.3681		0.3887	0.3836
	0.3863	0.3758		0.3912	0.3917
	0.3804	0.3721		0.3847	0.3877
T4	0.3840	0.3681	TC	0.3887	0.3837
	0.3898	0.3716		0.3950	0.3875
	0.3924	0.3794		0.3978	0.3958
	0.3863	0.3758		0.3912	0.3917
T5	0.3686	0.3649	TD	0.3719	0.3797
	0.3744	0.3685		0.3782	0.3837
	0.3763	0.3760		0.3802	0.3916
	0.3702	0.3722		0.3736	0.3874
T6	0.3744	0.3685	TE	0.3782	0.3837
	0.3804	0.3721		0.3847	0.3877
	0.3825	0.3798		0.3869	0.3958
	0.3763	0.376		0.3802	0.3916
T7	0.3804	0.3721	TF	0.3847	0.3877
	0.3863	0.3758		0.3912	0.3917
	0.3887	0.3836		0.3937	0.4001
	0.3825	0.3798		0.3869	0.3958
T8	0.3863	0.3758	TG	0.3912	0.3917
	0.3924	0.3794		0.3978	0.3958
	0.3950	0.3875		0.4006	0.4044
	0.3887	0.3836		0.3937	0.4001

e) Chromaticity Region & Coordinates

Region	CIE x	CIE y	Region	CIE x	CIE y
R rank (5000 K)					
R1	0.3366	0.3369	R9	0.3371	0.3490
	0.3369	0.3430		0.3374	0.3553
	0.3407	0.3460		0.3415	0.3587
	0.3403	0.3398		0.3411	0.3522
R2	0.3403	0.3398	RA	0.3411	0.3522
	0.3407	0.3460		0.3415	0.3587
	0.3446	0.3491		0.3457	0.3621
	0.3440	0.3427		0.3451	0.3554
R3	0.3440	0.3427	RB	0.3451	0.3554
	0.3446	0.3491		0.3457	0.3621
	0.3485	0.3522		0.3500	0.3655
	0.3478	0.3457		0.3492	0.3587
R4	0.3478	0.3457	RC	0.3492	0.3587
	0.3485	0.3522		0.3500	0.3655
	0.3524	0.3554		0.3542	0.3690
	0.3515	0.3487		0.3533	0.3620
R5	0.3369	0.3430	RD	0.3374	0.3553
	0.3371	0.3490		0.3376	0.3616
	0.3411	0.3522		0.3420	0.3652
	0.3407	0.3460		0.3415	0.3587
R6	0.3407	0.3460	RE	0.3415	0.3587
	0.3411	0.3522		0.3420	0.3652
	0.3451	0.3554		0.3463	0.3687
	0.3446	0.3491		0.3457	0.3621
R7	0.3446	0.3491	RF	0.3457	0.3621
	0.3451	0.3554		0.3463	0.3687
	0.3492	0.3587		0.3507	0.3724
	0.3485	0.3522		0.3500	0.3655
R8	0.3485	0.3522	RG	0.3500	0.3655
	0.3492	0.3587		0.3507	0.3724
	0.3533	0.3620		0.3551	0.3760
	0.3524	0.3554		0.3542	0.3690

Region	CIE x	CIE y	Region	CIE x	CIE y
Q rank (5700 K)					
Q1	0.3222	0.3243	Q9	0.3215	0.3350
	0.3219	0.3297		0.3211	0.3406
	0.3254	0.3328		0.3251	0.3442
	0.3256	0.3272		0.3253	0.3384
Q2	0.3294	0.3306	QA	0.3253	0.3384
	0.3293	0.3384		0.3251	0.3442
	0.3369	0.3451		0.3290	0.3478
	0.3366	0.3369		0.3290	0.3417
Q3	0.3290	0.3300	QB	0.3290	0.3417
	0.3290	0.3359		0.3290	0.3478
	0.3329	0.3394		0.3332	0.3515
	0.3328	0.3335		0.3331	0.3454
Q4	0.3293	0.3384	QC	0.3331	0.3454
	0.3292	0.3461		0.3332	0.3515
	0.3373	0.3534		0.3374	0.3553
	0.3369	0.3451		0.3371	0.3490
Q5	0.3219	0.3297	QD	0.3211	0.3406
	0.3215	0.3350		0.3207	0.3462
	0.3253	0.3384		0.3249	0.3500
	0.3254	0.3328		0.3251	0.3442
Q6	0.3292	0.3461	QE	0.3251	0.3442
	0.3292	0.3539		0.3249	0.3500
	0.3376	0.3616		0.3290	0.3538
	0.3373	0.3534		0.3290	0.3478
Q7	0.3290	0.3359	QF	0.3290	0.3478
	0.3290	0.3417		0.3290	0.3538
	0.3331	0.3454		0.3333	0.3577
	0.3329	0.3394		0.3332	0.3515
Q8	0.3295	0.3228	QG	0.3332	0.3515
	0.3294	0.3306		0.3333	0.3577
	0.3366	0.3369		0.3376	0.3616
	0.3363	0.3287		0.3374	0.3553

e) Chromaticity Region & Coordinates

Region	CIE x	CIE y	Region	CIE x	CIE y
P rank (6500 K)					
P1	0.3068	0.3113	P9	0.3048	0.3207
	0.3145	0.3187		0.3089	0.3249
	0.3135	0.3256		0.3080	0.3298
	0.3055	0.3177		0.3038	0.3256
P2	0.3145	0.3187	PA	0.3089	0.3249
	0.3221	0.3261		0.3130	0.3290
	0.3216	0.3334		0.3123	0.3341
	0.3135	0.3256		0.3080	0.3298
P3	0.3055	0.3177	PB	0.3130	0.3290
	0.3135	0.3256		0.3172	0.3332
	0.3126	0.3324		0.3166	0.3384
	0.3041	0.3240		0.3123	0.3341
P4	0.3135	0.3256	PC	0.3172	0.3332
	0.3216	0.3334		0.3213	0.3373
	0.3211	0.3408		0.3209	0.3427
	0.3126	0.3324		0.3166	0.3384
P5	0.3041	0.3240	PD	0.3038	0.3256
	0.3126	0.3324		0.3080	0.3298
	0.3117	0.3393		0.3072	0.3348
	0.3028	0.3304		0.3028	0.3304
P6	0.3126	0.3324	PE	0.3080	0.3298
	0.3211	0.3408		0.3123	0.3341
	0.3206	0.3481		0.3115	0.3391
	0.3117	0.3393		0.3072	0.3348
P7	0.3081	0.3049	PF	0.3123	0.3341
	0.3154	0.3119		0.3166	0.3384
	0.3145	0.3187		0.3160	0.3436
	0.3068	0.3113		0.3115	0.3391
P8	0.3154	0.3119	PG	0.3166	0.3384
	0.3226	0.3188		0.3209	0.3427
	0.3221	0.3261		0.3205	0.3481
	0.3145	0.3187		0.3160	0.3436

Note: Samsung maintains measurement tolerance of: $C_x, C_y = \pm 0.005$

f) Kitting Chromaticity Region & Coordinates ($I_F = 150 \text{ mA}$, $T_s = 25^\circ\text{C}$)

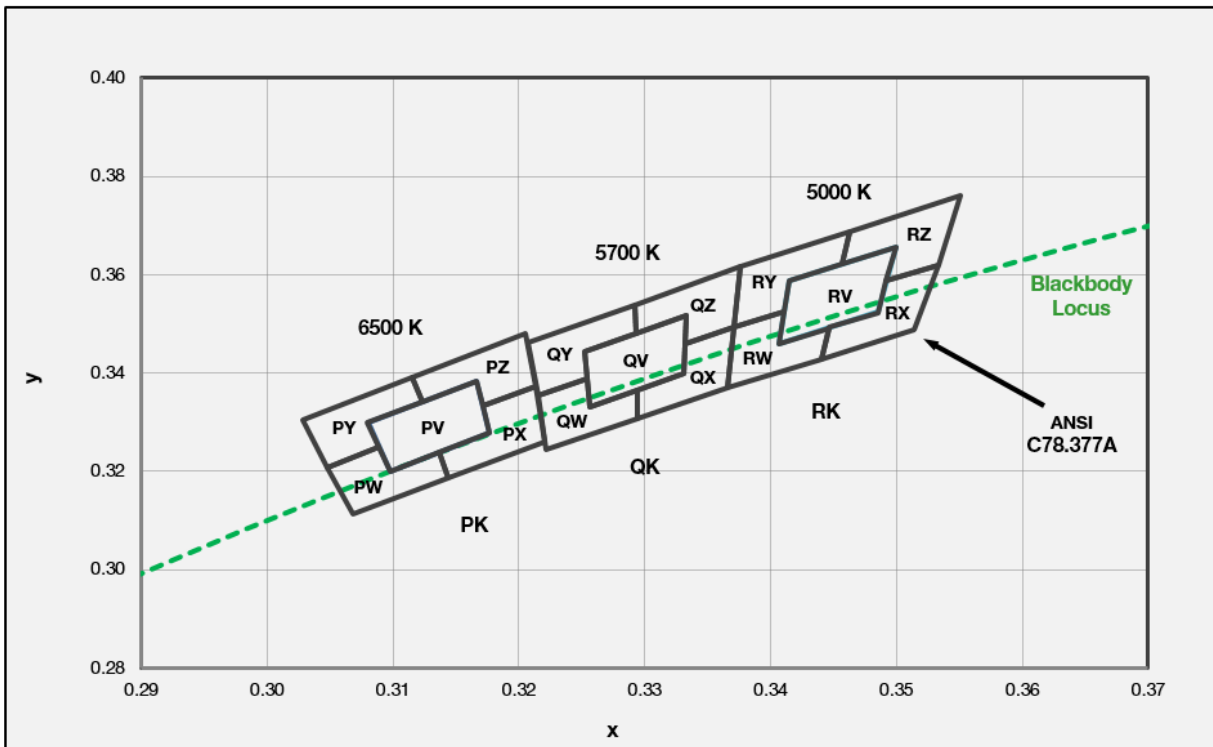
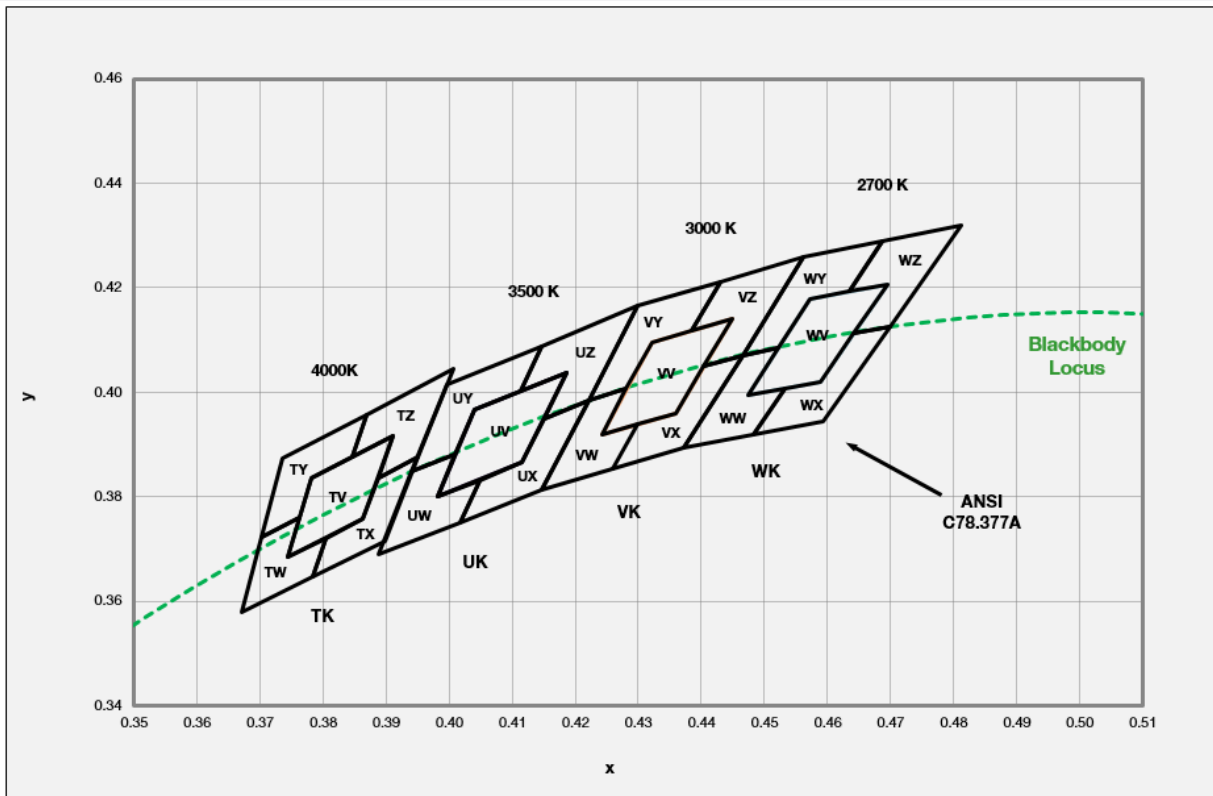

f) Kitting Chromaticity Region & Coordinates

Region	CIE x	CIE y	Region	CIE x	CIE y
W rank (2700 K)					
WV	0.4475	0.3994			
	0.4589	0.4021			
	0.4695	0.4207			
	0.4573	0.4178			
WW	0.4373	0.3893	WY	0.4465	0.4071
	0.4483	0.3919		0.4523	0.4085
	0.4532	0.4008		0.4573	0.4178
	0.4475	0.3994		0.4634	0.4193
	0.4523	0.4085		0.4687	0.4289
	0.4465	0.4071		0.4562	0.4260
WX	0.4483	0.3919	WZ	0.4641	0.4112
	0.4593	0.3944		0.4700	0.4126
	0.4700	0.4126		0.4813	0.4319
	0.4641	0.4112		0.4687	0.4289
	0.4589	0.4021		0.4634	0.4193
	0.4532	0.4008		0.4695	0.4207

Region	CIE x	CIE y	Region	CIE x	CIE y
V rank (3000 K)					
VW	0.4242	0.3919			
	0.4359	0.3960			
	0.4449	0.4141			
	0.4322	0.4096			
VW	0.4147	0.3814	VY	0.4221	0.3984
	0.4259	0.3853		0.4281	0.4006
	0.4300	0.3939		0.4322	0.4096
	0.4242	0.3919		0.4385	0.4119
	0.4281	0.4006		0.4430	0.4212
	0.4221	0.3984		0.4299	0.4165
VX	0.4259	0.3853	VZ	0.4403	0.4049
	0.4373	0.3893		0.4465	0.4071
	0.4465	0.4071		0.4562	0.4260
	0.4403	0.4049		0.4430	0.4212
	0.4359	0.3960		0.4385	0.4119
	0.4300	0.3939		0.4449	0.4141

Region	CIE x	CIE y	Region	CIE x	CIE y
U rank (3500 K)					
UV	0.3981	0.3800			
	0.4116	0.3865			
	0.4186	0.4037			
	0.4040	0.3966			
UW	0.3889	0.3690	UY	0.3941	0.3848
	0.4017	0.3751		0.4010	0.3882
	0.4048	0.3832		0.4040	0.3966
	0.3981	0.3800		0.4113	0.4001
	0.4010	0.3882		0.4146	0.4089
	0.3941	0.3848		0.3996	0.4015
UX	0.4017	0.3751	UZ	0.4150	0.3950
	0.4147	0.3814		0.4221	0.3984
	0.4221	0.3984		0.4299	0.4165
	0.4150	0.3950		0.4146	0.4089
	0.4116	0.3865		0.4113	0.4001
	0.4048	0.3832		0.4186	0.4037

Region	CIE x	CIE y	Region	CIE x	CIE y
T rank (4000 K)					
TV	0.3744	0.3685			
	0.3863	0.3758			
	0.3912	0.3917			
	0.3782	0.3837			
TW	0.3670	0.3578	TY	0.3702	0.3722
	0.3783	0.3646		0.3763	0.3760
	0.3804	0.3721		0.3782	0.3837
	0.3744	0.3685		0.3847	0.3877
	0.3763	0.3760		0.3869	0.3958
	0.3702	0.3722		0.3736	0.3874
TX	0.3783	0.3646	TZ	0.3887	0.3837
	0.3898	0.3716		0.3950	0.3875
	0.3950	0.3875		0.4006	0.4044
	0.3887	0.3837		0.3869	0.3958
	0.3863	0.3758		0.3847	0.3877
	0.3804	0.3721		0.3912	0.3917



f) Kitting Chromaticity Region & Coordinates

Region	CIE x	CIE y	Region	CIE x	CIE y
R rank (5000 K)					
RV	0.3407	0.3460			
	0.3485	0.3524			
	0.3500	0.3655			
	0.3415	0.3588			
RW	0.3366	0.3369	RY	0.3371	0.3493
	0.3440	0.3427		0.3411	0.3525
	0.3446	0.3491		0.3415	0.3588
	0.3407	0.3460		0.3457	0.3621
	0.3411	0.3525		0.3463	0.3687
	0.3371	0.3493		0.3376	0.3616
RX	0.3440	0.3428	RZ	0.3457	0.3621
	0.3514	0.3487		0.3500	0.3655
	0.3533	0.3620		0.3492	0.3587
	0.3492	0.3587		0.3533	0.3620
	0.3485	0.3522		0.3551	0.3760
	0.3446	0.3493		0.3463	0.3687

Region	CIE x	CIE y	Region	CIE x	CIE y
Q rank (5700 K)					
QV	0.3256	0.3331			
	0.3331	0.3398			
	0.3333	0.3518			
	0.3252	0.3444			
QW	0.3222	0.3243	QY	0.3215	0.3353
	0.3294	0.3306		0.3254	0.3388
	0.3294	0.3364		0.3252	0.3444
	0.3256	0.3331		0.3293	0.3481
	0.3254	0.3388		0.3292	0.3539
	0.3215	0.3353		0.3207	0.3462
QX	0.3294	0.3306	QZ	0.3293	0.3481
	0.3366	0.3369		0.3333	0.3518
	0.3371	0.3493		0.3332	0.3458
	0.3332	0.3458		0.3371	0.3493
	0.3331	0.3398		0.3376	0.3616
	0.3294	0.3364		0.3292	0.3539

Region	CIE x	CIE y	Region	CIE x	CIE y
P rank (6500 K)					
PV	0.3098	0.3199			
	0.3177	0.3278			
	0.3166	0.3384			
	0.3080	0.3298			
PW	0.3068	0.3113	PY	0.3048	0.3207
	0.3144	0.3186		0.3089	0.3249
	0.3137	0.3238		0.308	0.3298
	0.3098	0.3199		0.3123	0.3341
	0.3089	0.3249		0.3115	0.3391
	0.3048	0.3207		0.3028	0.3304
PX	0.3144	0.3186	PZ	0.3123	0.3341
	0.3221	0.3261		0.3166	0.3384
	0.3213	0.3373		0.3172	0.3332
	0.3172	0.3332		0.3213	0.3373
	0.3177	0.3278		0.3205	0.3481
	0.3137	0.3238		0.3115	0.3391

Note:

Samsung maintains measurement tolerance of: Cx, Cy = ±0.005

3. Typical Characteristics Graphs

a) Spectrum Distribution ($I_f = 150 \text{ mA}$, $T_s = 25 \text{ }^\circ\text{C}$)

CCT: 2700 K (80 CRI)



CCT: 3000 K (80 CRI)

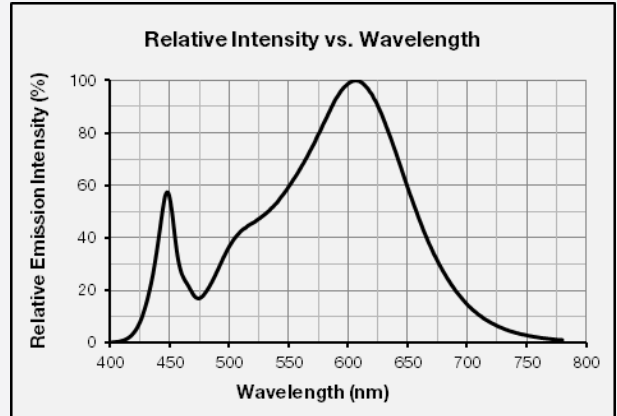

CCT: 3500 K (80 CRI)

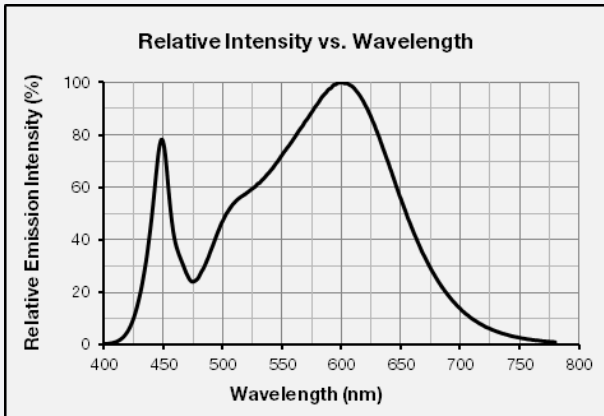

CCT: 4000 K (80 CRI)

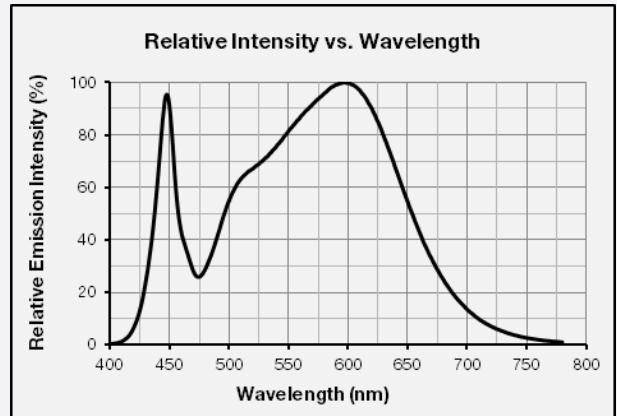

CCT: 5000 K (80 CRI)

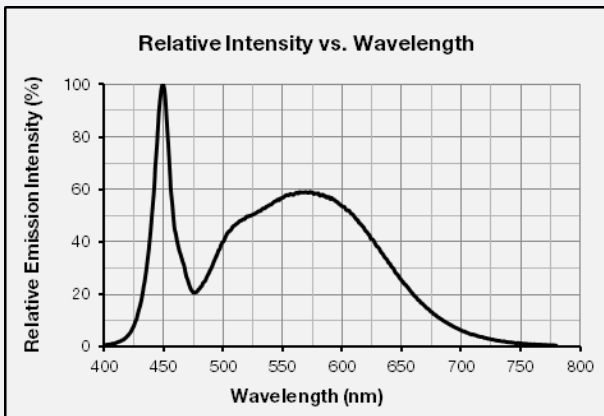

CCT: 5700 K (80 CRI)

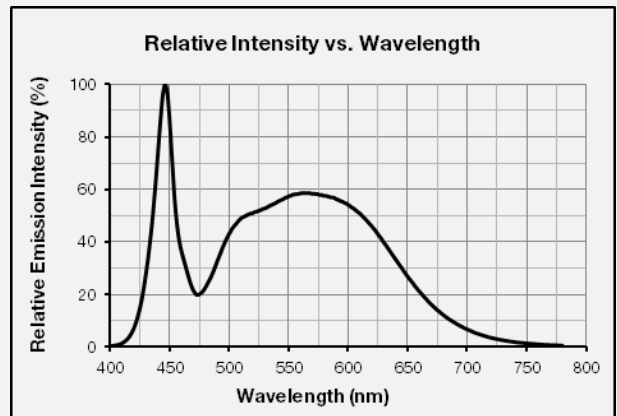

CCT: 6500 K (80 CRI)



b) Forward Current Characteristics ($T_s = 25\text{ }^\circ\text{C}$)



c) Temperature Characteristics ($I_f = 150\text{ mA}$)



d) Color Shift Characteristics ($I_f = 150 \text{ mA}$, $T_s = 25 \text{ }^\circ\text{C}$)



e) Derating Curve



f) Beam Angle Characteristics ($I_f = 150 \text{ mA}$, $T_s = 25 \text{ }^\circ\text{C}$)



4. Outline Drawing & Dimension

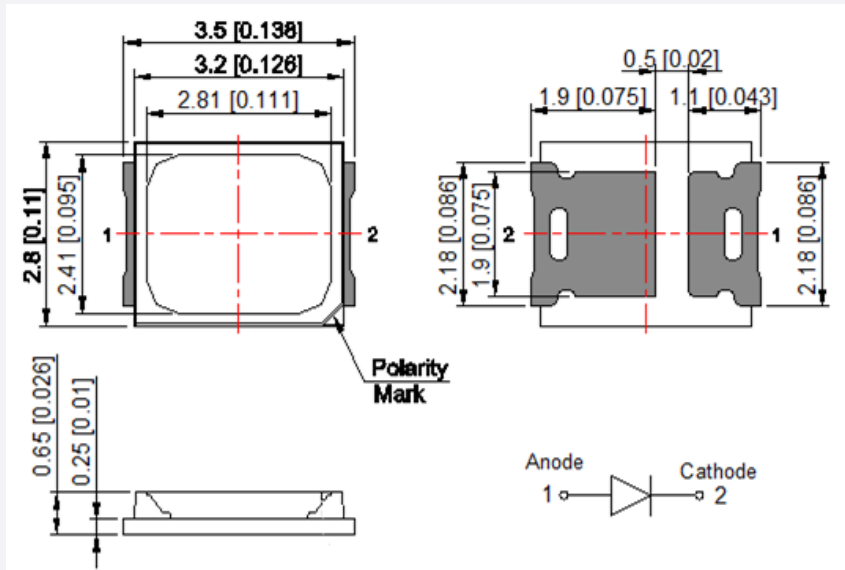

- Measurement unit: mm
- Tolerance: $\pm 0.1\text{mm}$

[Recommended PCB Solder PAD]



Notes:

- 1) This LED has built-in ESD protection device(s) connected in parallel to LED chip(s).
- 2) T_s point and measurement method:
 - ① Measure one point at the cathode pad, if necessary remove PSR of PCB to reach T_s point.
 - ② All pads must be soldered to the PCB to dissipate heat properly, otherwise the LED can be damaged.

Precautions:

- 1) Pressure on the LEDs will influence to the reliability of the LEDs. Precautions should be taken to avoid strong pressure on the LEDs. Do not put stress on the LEDs during heating.
- 2) Re-soldering should not be done after the LEDs have been soldered. If re-soldering is unavoidable, LED's characteristics should be carefully checked before and after such repair.
- 3) Do not stack assembled PCBs together. Since materials of LEDs is soft, abrasion between two PCB assembled with LED might cause catastrophic failure of the LEDs.

5. Reliability Test Items & Conditions

a) Test Items

Test Item	Test Condition	Test Hour / Cycle	Sample No.
Room Temperature Life Test	25 °C, DC 160 mA	1000 h	22
High Temperature Life Test	85 °C, DC 160 mA	1000 h	22
High Temperature Humidity Life Test	85 °C, 85 % RH, DC 160 mA	1000 h	22
Low Temperature Life Test	-40 °C, DC 160 mA	1000 h	22
Powered Temperature Cycle Test	-45 °C ~ 85 °C, each 20 min, on/off 5 min Temp. Change time 100min, DC 160 mA	100 cycles	22
Temperature Cycle	-40°C / 15 min ↔ 100 °C / 15 min	200 cycles	100
High Temperature Storage	120 °C	1000 h	11
Low Temperature Storage	-40 °C	1000 h	11

ESD (HBM)



R₁: 10 MΩ
 R₂: 1.5 kΩ
 C: 100 pF
 V: ±2 kV

5 times

30

b) Criteria for Judging the Damage

Item	Symbol	Test Condition (T _s = 25 °C)	Limit	
			Min	Max
Forward Voltage	V _F	I _F = 160 mA	Init. Value * 0.9	Init. Value * 1.1
Luminous Flux	Φ _v	I _F = 160 mA	Init. Value * 0.7	Init. Value * 1.1

6. Soldering Conditions

a) Reflow Conditions (Pb free)

Reflow frequency: 2 times max.



b) Manual Soldering Conditions

Not more than 5 seconds @ max. 300 °C, under soldering iron.

b) Reel Dimension

(unit: mm)

**Notes:**

- 1) Quantity: The quantity/reel is 4,000 pcs
- 2) All dimensions are millimeters (tolerance : $\pm 0.2\text{mm}$)
- 3) Packaging: P/N, Manufacturing data code no. and quantity are indicated on the aluminum packing bag

8. Label Structure

a) Label Structure



Note: Denoted bin code and product code above is only an example (see description on page 5)

Bin Code:

- ⒶⒷ: Forward Voltage bin (refer to page 10)
- ⒸⒹ: Chromaticity bin (refer to page 11-18)
- ⒺⒻ: Luminous Flux bin (refer to page 7)

b) Lot Number

The lot number is composed of the following characters:



①②③④⑤⑥⑦⑧⑨ / 1ⒶⒷⒸ / 4,000 pcs

- ① : Production site (S: Giheung, Korea, G: Tianjin, China)
- ② : 3 (LED)
- ③ : Product state (A: Normal, B: Bulk, C: First Production, R: Reproduction, S: Sample)
- ④ : Year (Z: 2015, A: 2016, B: 2017...)
- ⑤ : Month (1~9, A, B, C)
- ⑥⑦⑧⑨ : Day (1~9, A, B~V)
- ⒶⒷⒸ : Product serial number (001 ~ 999)

9. Packing Structure

a) Packing Process

Reel

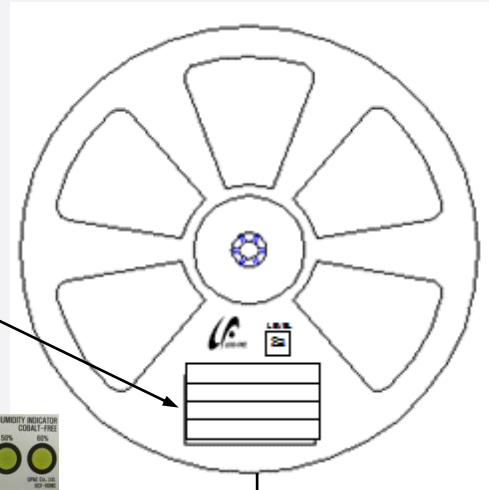
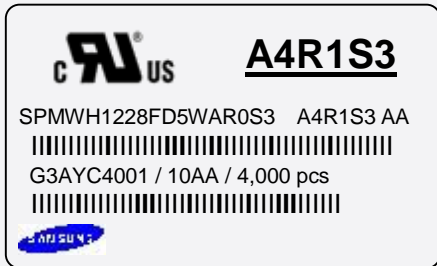

Aluminum Vinyl Packing Bag



Outer Box

Material: Paper (SW3B(B))

Type	Size (mm)			Note
	L	W	H	
7 inch L	245 ± 5	220 ± 5	182 ± 5	Up to 10 reels
7 inch S	245 ± 5	220 ± 5	86 ± 5	Up to 5 reels

① Side Label

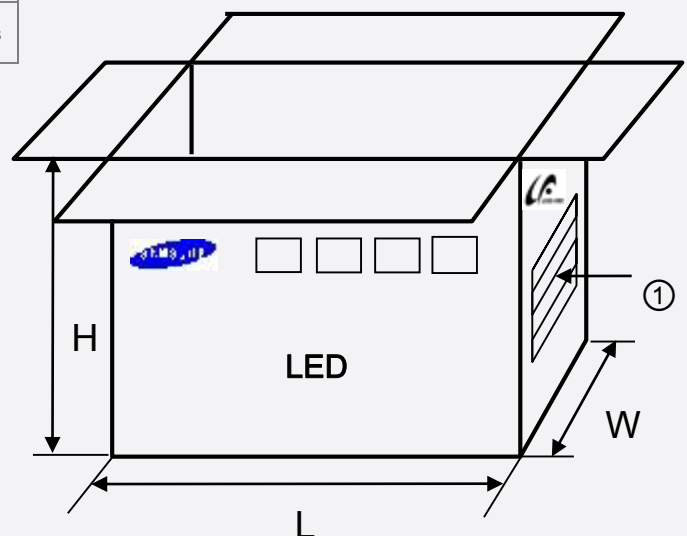
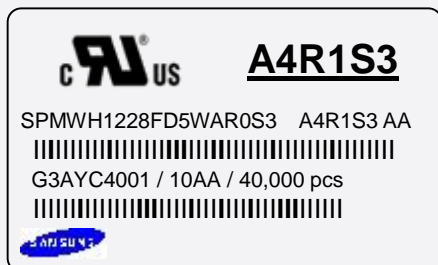

b) Packing Process for kitting

Reel

Kitting 'A'

CU[®] US A3★WS3
 SPMWH1228FD5WA★KS0 A3★WS3 AA
 G3AW94001 / 10AA / 4,000 pcs

Kitting 'B'

CU[®] US A3★ZS3
 SPMWH1228FD5WA★KS0 A3★ZS3 AA
 G3AW94001 / 10AA / 4,000 pcs



Aluminum Vinyl Packing Bag

Kitting 'A'

CU[®] US A3★WS3
 SPMWH1228FD5WA★KS0 A3★WS3 AA
 G3AW94001 / 10AA / 4,000 pcs

Kitting 'B'

CU[®] US A3★ZS3
 SPMWH1228FD5WA★KS0 A3★ZS3 AA
 G3AW94001 / 10AA / 4,000 pcs

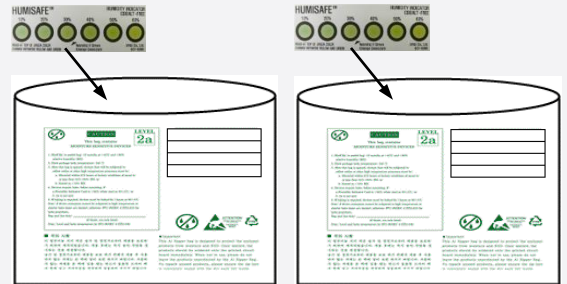

Outer Box

Kitting 'A'

CU[®] US A3★WS4
 SPMWH1228FD5WA★KS0 A3★WS3 AA
 G3AW94001 / 10AA / 20,000 pcs
 [BOX Label]

Kitting 'B'

CU[®] US A3★ZS4
 SPMWH1228FD5WA★KS0 A3★ZS3 AA
 G3AW94001 / 10AA / 20,000 pcs
 [BOX Label]

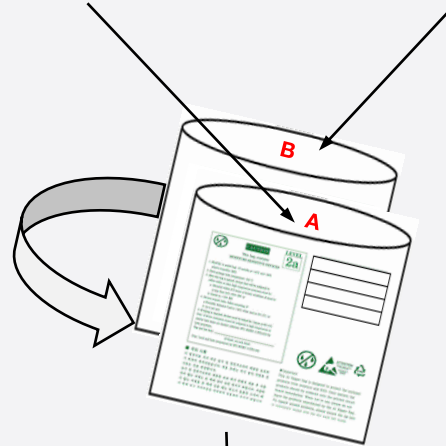

Material: Paper (SW3B(B))

Type	Size (mm)			Note
	L	W	H	
7 inch L	245 ± 5	220 ± 5	182 ± 5	Up to 10 reels



b) Aluminum Vinyl Packing Bag



CAUTION

This bag contains
MOISTURE SENSITIVE DEVICES

LEVEL

2a



A4R1S3

SPMWH1228FD5WAR0S3 A4R1S3 AA
 G3AYC4001 / 10AA / 4,000 pcs









ATTENTION
OBSERVE PRECAUTIONS
FOR HANDLING
ELECTROSTATIC
SENSITIVE
DEVICES



1. Shelf life in sealed bag: 12 months at <40℃ and <90% relative humidity (RH)

2. Peak package body temperature: 240 ℃

3. After this bag is opened, devices that will be subjected to reflow solder or other high temperature processes must be:

- a. Mounted within 672 hours at factory conditions of equal to or less than 30℃ /60% RH, or
- b. Stored at <10% RH

4. Devices require bake, before mounting, if:

- a. Humidity Indicator Card is >/60% when read at 23±5℃, or
- b. 2a is not met.

5. If baking is required, devices must be baked for 10 ~ 24 hours at 60±5℃

Note: If device containers cannot be subjected to high temperature or shorter bake times are desired, reference IPC/JEDEC J-STD-033 for bake procedure.

Bag seal due date: _____
(If blank, see code label)

Note: Level and body temperature by IPC/JEDEC J-STD-020

주의 사항

이 알루미늄 지퍼 백은 습기 및 정전기로부터 제품을 보호하기 위하여 제작되었습니다. 개봉 후에는 즉시 솔더 작업을 실시하는 것을 권장합니다.

습기 및 정전기로부터 제품을 보호 하기 위해서 개봉 후 사용하지 않는 자재는 본 팩에 넣어 보관 하시기 바랍니다. 사용하지 않는 자재를 본 팩에 넣을 때는 반드시 동봉된 드라이 팩과 함께 넣고 지퍼부분을 완전하게 밀봉하여 주시기 바랍니다.

Important

This Al Zipper bag is designed to protect the enclosed products from moisture and ESD. Once opened, the products should be soldered onto the printed circuit board immediately. When not in use, please do not leave the products unprotected by the Al Zipper Bag. To repack unused products., please ensure the zip-lock is completely sealed with the dry pack left inside.

c) Humidity Indicator Card inside Aluminum Vinyl Bag



10. Precautions in Handling & Use

- 1) For over-current protection, users are recommended to apply resistors connected in series with the LEDs to mitigate sudden change of the forward current caused by shift of forward voltage.
- 2) This device should not be used in any type of fluid such as water, oil, organic solvent, etc. When cleaning is required, IPA is recommended as the cleaning agent. Some solvent-based cleaning agent may damage the silicone resins used in the device.
- 3) When the device is in operation, the forward current should be carefully determined considering the maximum ambient temperature and corresponding junction temperature.
- 4) LEDs must be stored in a clean environment. If the LEDs are to be stored for three months or more after being shipped from Samsung, they should be packed with a nitrogen-filled container (shelf life of sealed bags is 12 months at temperature 0~40 °C, 0~90 % RH).
- 5) After storage bag is opened, device subjected to soldering, solder reflow, or other high temperature processes must be:
 - a. Mounted within 672 hours (28 days) at an assembly line with a condition of no more than 30 °C / 60 % RH, or
 - b. Stored at <10 % RH
- 6) Repack unused devices with anti-moisture packing, fold to close any opening and then store in a dry place.
- 7) Devices require baking before mounting, if humidity card reading is >60 % at 23 ± 5 °C.
- 8) Devices must be baked for 1 hour at 60 ± 5 °C, if baking is required.
- 9) The LEDs are sensitive to the static electricity and surge current. It is recommended to use a wrist band or anti-electrostatic glove when handling the LEDs. If voltage exceeding the absolute maximum rating is applied to LEDs, it may cause damage or even destruction to LED devices. Damaged LEDs may show some unusual characteristics such as increase in leakage current, lowered turn-on voltage, or abnormal lighting of LEDs at low current.
- 10) VOCs (Volatile Organic Compounds) can be generated from adhesives, flux, hardener or organic additives used in luminaires (fixtures). Transparent LED silicone encapsulant is permeable to those chemicals and they may lead to a discoloration of encapsulant when they exposed to heat or light. This phenomenon can cause a significant loss of light emitted (output) from the luminaires. In order to prevent these problems, we recommend users to know the physical properties of materials used in luminaires and they must be carefully selected.
- 11) Risk of sulfurization (or tarnishing)

The LED from Samsung uses a silver-plated lead frame and its surface color may change to black (or dark colored) when it is exposed to sulfur (S), chlorine (Cl) or other halogen compound. Sulfurization of lead frame may cause intensity degradation, change of chromaticity coordinates and, in extreme cases, open circuit. It requires caution. Due to possible sulfurization of lead frame, LED should not be used and stored together with oxidizing substances made of materials such as rubber, plain paper, lead solder cream, etc.

Legal and additional information.

[About Samsung Electronics Co., Ltd.](#)

Samsung Electronics Co., Ltd. is a global leader in technology, opening new possibilities for people everywhere. Through relentless innovation and discovery, we are transforming the worlds of TVs, smartphones, tablets, PCs, cameras, home appliances, printers, LTE systems, medical devices, semiconductors and LED solutions. We employ 286,000 people across 80 countries with annual sales of US\$216.7 billion. To discover more, please visit www.samsungled.com.

Copyright © 2015 Samsung Electronics Co., Ltd. All rights reserved.
Samsung is a registered trademark of Samsung Electronics Co., Ltd.
Specifications and designs are subject to change without notice. Non-metric weights and measurements are approximate. All data were deemed correct at time of creation. Samsung is not liable for errors or omissions. All brand, product, service names and logos are trademarks and/or registered trademarks of their respective owners and are hereby recognized and acknowledged.

Samsung Electronics Co., Ltd.
95, Samsung 2-ro
Giheung-gu
Yongin-si, Gyeonggi-do, 446-711
KOREA

www.samsungled.com



Looking for pricing, stock, or lifecycle information?

Click below to explore more details on WIN SOURCE:

- ⊖ [View SPMWH1228FD5WAWMS3 on WIN SOURCE](#)
- ⊖ [Samsung Information](#)

Optimize Your Supply Chain with WIN SOURCE Solutions

- ✓ Global Sourcing Solution
- ✓ Obsolete Management
- ✓ Cost Control Management
- ✓ Shortage Management
- ✓ Alternative Solution
- ✓ Excess Inventory Management