



**THE DATASHEET OF  
SPMWH1228FD7WAQ0SC**



Middle Power LED Series  
2835 0.5W Room Temp

# LM281B+

## SCrank



Designed for better lm/\$ (Ambient, Linear)

### Features & Benefits

- 0.5W Class mid power LED
- Standard form factor for design flexibility (2.8 × 3.5 mm)



## Table of Contents

1.	Characteristics	-----	3
2.	Product Code Information	-----	6
3.	Typical Characteristics Graphs	-----	21
4.	Outline Drawing & Dimension	-----	26
5.	Reliability Test Items & Conditions	-----	27
6.	Soldering Conditions	-----	28
7.	Tape & Reel	-----	29
8.	Label Structure	-----	32
9.	Packing Structure	-----	33
10.	Precautions in Handling & Use	-----	37

## 1. Characteristics

### a) Absolute Maximum Rating

Item	Symbol	Rating	Unit	Condition
Ambient / Operating Temperature	$T_a$	-40 ~ +85	°C	-
Storage Temperature	$T_{stg}$	-40 ~ +85	°C	-
LED Junction Temperature	$T_j$	115	°C	-
Forward Current	$I_F$	200	mA	-
Peak Pulsed Forward Current	$I_{FP}$	300	mA	Duty 1/10, pulse width 10ms
Assembly Process Temperature	-	260 <10	°C s	-
ESD (HBM)	-	2	kV	-

#### Note:

Proper current derating must be observed to maintain junction temperature below the maximum at all time.

It is recommended minimum current 10mA in order to avoid un-even brightness, and may vary depending on circuit configuration.

**b) Electro-optical Characteristics** ( $I_F = 150 \text{ mA}$ ,  $T_a = 25 \text{ }^\circ\text{C}$ )

Item	Unit	Rank	Bin	Min.	Typ.	Max.
Forward Voltage (VF)	V	WA or WK	A1	2.8		2.9
			A2	2.9		3.0
			A3	3.0		3.1
			A4	3.1		3.2
		WN or WM	A1	2.8		2.9
			A2	2.9		3.0
Color Rendering Index (Ra)	-	5		80	-	-
		7		90		
Special CRI (R9)	For Ra 90			50		
Thermal Resistance (junction to solder point)	$^\circ\text{C/W}$			-	25	-
Beam Angle	$^\circ$			-	120	-

**Note:**

Samsung maintains measurement tolerance of: forward voltage =  $\pm 0.1 \text{ V}$ , CRI =  $\pm 3$ , R9 =  $\pm 6.5$

**c) Electro-optical Characteristics (I<sub>F</sub> = 150 mA, T<sub>a</sub> = 25 °C)**

Item	CRI (R <sub>a</sub> ) Min.	Nominal CCT (K)	Bin	150mA	
				Min.	Max.
Luminous Flux (Φ <sub>v</sub> )	80	2700	SC	58.5	62.5
		3000	SC	60.5	64.5
		3500	SC	61.5	65.5
		4000	SC	64.0	68.0
		5000	SC	65.0	69.0
		5700	SC	64.5	68.5
		6500	SC	64.0	68.0
	90	2700	SC	48.5	52.5
		3000	SC	50.0	54.0
		3500	SC	51.0	55.0
		4000	SC	53.0	57.0
		5000	SC	54.0	58.0
		5700	SC	53.5	57.5
		6500	SC	53.0	57.0

**Note:**

Samsung maintains measurement tolerance of: forward voltage = ±0.1V, luminous flux = ±5 %, CRI = ±3

## 2. Product Code Information

1	2	3	4	5	6	7	8	9	10	11	12	13	14	15	16	17	18
S	P	M	W	H	1	2	2	8	F	D	5	W	A	R	0	S	C

Digit	PKG Information	Code	Specification			
1 2 3	Samsung Package Middle Power	SPM	Middle power			
4 5	Color	WH	White			
6	Product Version	1	Without Zener			
7 8 9	Form Factor	228	2.8 x 3.5 x 0.70 mm; 2 pads			
10	Sorting Current (mA)	F	150 mA			
11	Chromaticity Coordinates	D	ANSI Standard			
12	CRI	5	Min. 80			
		7	Min. 90			
13 14	Forward Voltage (V)	WA or WK	2.8~3.2	Bin code	A1	2.8 ~ 2.9
					A2	2.9 ~ 3.0
				A3	3.0 ~ 3.1	
				A4	3.1 ~ 3.2	
			WA : 4,000ea per reel ,WK : 16,000ea per reel			
13 14	Forward Voltage (V)	WN or WM	2.8~3.0	Bin code	A1	2.8 ~ 2.9
					A2	2.9 ~ 3.0
			WN : 4,000ea per reel ,WM : 16,000ea per reel			
15 16	CCT (K)	W☆	2700	Bin Code:	W1, W2, W3, W4, W5, W6, W7, W8, W9, WA, WB, WC, WD, WE, WF, WG, WN, WP, WQ, WR, WS, WT, WU	
		V☆	3000		V1, V2, V3, V4, V5, V6, V7, V8, V9, VA, VB, VC, VD, VE, VF, VG, VN, VP, VQ, VR, VS, VT, VU	
		U☆	3500		U1, U2, U3, U4, U5, U6, U7, U8, U9, UA, UB, UC, UD, UE, UF, UG, UN, UP, UQ, UR, US, UT, UU	
		T☆	4000		T1, T2, T3, T4, T5, T6, T7, T8, T9, TA, TB, TC, TD, TE, TF, TG, TN, TP, TQ, TR, TS, TT, TU	
		R☆	5000		R1, R2, R3, R4, R5, R6, R7, R8, R9, RA, RB, RC, RD, RE, RF, RG, RN, RP, RQ, RR, RS, RT, RU	
		Q☆	5700		Q1, Q2, Q3, Q4, Q5, Q6, Q7, Q8, Q9, QA, QB, QC, QD, QE, QF, QG, QN, QP, QQ, QR, QS, QT, QU	
		P☆	6500		P1, P2, P3, P4, P5, P6, P7, P8, P9, PA, PB, PC, PD, PE, PF, PG, PN, PP, PQ, PR, PS, PT, PU	
		☆ : "0" (Whole bin), "M" (Quarter bin), "K" (K Kitting bin), "Y"(Y Kitting bin) or "U" (Mac3 only)				
17 18	Luminous Flux	SC	Bin Code	SC		

### a) Luminous Flux Bins ( $I_F = 150 \text{ mA}$ , $T_a = 25^\circ\text{C}$ )

CRI (R <sub>a</sub> ) Min.	Nominal CCT (K)	Product Code	Flux Bin	Flux Range (Φ <sub>v</sub> , lm)
80	2700	SPMWH1228FD5WAW☆SC	SC	58.5 ~ 62.5
	3000	SPMWH1228FD5WAV☆SC	SC	60.5 ~ 64.5
	3500	SPMWH1228FD5WAU☆SC	SC	61.5 ~ 65.5
	4000	SPMWH1228FD5WAT☆SC	SC	64.0 ~ 68.0
	5000	SPMWH1228FD5WAR☆SC	SC	65.0 ~ 69.0
	5700	SPMWH1228FD5WAQ☆SC	SC	64.5 ~ 68.5
	6500	SPMWH1228FD5WAP☆SC	SC	64.0 ~ 68.0
	90	2700	SPMWH1228FD7WAW☆SC	SC
3000		SPMWH1228FD7WAV☆SC	SC	50.0 ~ 54.0
3500		SPMWH1228FD7WAU☆SC	SC	51.0 ~ 55.0
4000		SPMWH1228FD7WAT☆SC	SC	53.0 ~ 57.0
5000		SPMWH1228FD7WAR☆SC	SC	54.0 ~ 58.0
5700		SPMWH1228FD7WAQ☆SC	SC	53.5 ~ 57.5
6500		SPMWH1228FD7WAP☆SC	SC	53.0 ~ 57.0

#### Note:

"☆" can be "0" (Whole bin), "M" (Quarter bin), "K" (K Kitting bin), "Y" (Y Kitting bin) or "U" (Mac3 only) of the color binning

## b) Kitting rule

### 1) K Kitting bin Concept

1. Under agreement between customer and SAMSUNG ELECTRONICS, SAMSUNG can supply kitting bin (VF, Color, Im).
2. A forward voltage (VF) of kitting bin is combined by a pair of same VF rank such as (A1+A1), (A2+A2), (A3+A3) or (A4+A4)
3. A Chromaticity Coordinates of kitting bin is mixed by kitting procedure.(below kitting simulation)

#### [Kitting example]

D	E	F	G
9	A	B	C
5	6	7	8
1	2	3	4

#### [Binning Information]

	Bin #1	Bin #2
VF	A1	A1
	A2	A2
	A3	A3
	A4	A4
CIE	1, 2, 5 bin	C, F, G bin
	6, 7, A, B bin	6, 7, A, B bin
	3, 4, 8 bin	9, D, E bin

## 2) Y Kitting bin Concept

4. Under agreement between customer and SAMSUNG ELECTRONICS, SAMSUNG can supply kitting bin (VF, Color, Im).
5. A forward voltage (VF) of kitting bin is combined by a pair of same VF rank such as (A1+A1), (A2+A2), (A3+A3) or (A4+A4)
6. A Chromaticity Coordinates of kitting bin is mixed by kitting procedure.(below kitting simulation)

### [Kitting example]

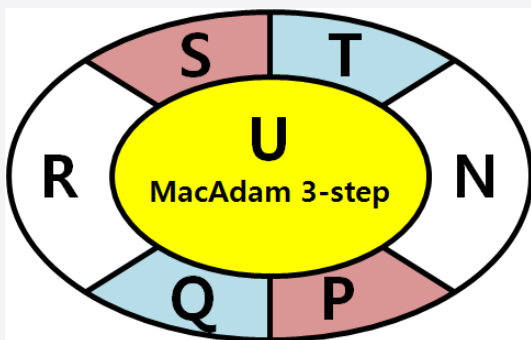

### [Binning Information]

	Bin #1	Bin #2
VF	A1	A1
	A2	A2
	A3	A3
	A4	A4
CIE	U	U
	N	R
	P	S
	Q	T

c) Color Bins ( $I_F = 150 \text{ mA}$ ,  $T_a = 25 \text{ }^\circ\text{C}$ )

CRI (R <sub>a</sub> ) Min.	Nominal CCT (K)	Product Code	Color Rank	Chromaticity Bins
80 or 90	2700	SPMWH1228FD★WAW0SC	W0 (Whole bin)	W1,W2,W3,W4,W5,W6,W7,W8,W9,WA,WB,WC,WD,WE,WF,WG
		SPMWH1228FD★WAWMSC	WM (Quarter bin)	W6, W7, WA, WB
		SPMWH1228FD★WAWKSC	WK (K Kitting bin)	W1,W2,W3,W4,W5,W6,W7,W8,W9,WA,WB,WC,WD,WE,WF,WG
		SPMWH1228FD★WAWUSC	WU (Mac3 Only)	WU
	SPMWH1228FD★WAWYSC	WY (Y Kitting bin)	WN, WP, WQ, WR, WS, WT, WU	
	3000	SPMWH1228FD★WAV0SC	V0 (Whole bin)	V1, V2, V3, V4, V5, V6, V7, V8,V9, VA, VB, VC, VD, VE, VF, VG
		SPMWH1228FD★WAVMSC	VM (Quarter bin)	V6, V7, VA, VB
		SPMWH1228FD★WAVKSC	VK (K Kitting bin)	V1, V2, V3, V4, V5, V6, V7, V8,V9, VA, VB, VC, VD, VE, VF, VG
		SPMWH1228FD★WAVUSC	VU (Mac3 Only)	VU
		SPMWH1228FD★WAVYSC	VY (Y Kitting bin)	VN, VP, VQ, VR, VS, VT, VU
	3500	SPMWH1228FD★WAU0SC	U0 (Whole bin)	U1, U2, U3, U4, U5, U6, U7, U8,U9, UA, UB, UC, UD, UE, UF, UG
		SPMWH1228FD★WAUMSC	UM (Quarter bin)	U6, U7, UA, UB
SPMWH1228FD★WAUKSC		UK (K Kitting bin)	U1, U2, U3, U4, U5, U6, U7, U8,U9, UA, UB, UC, UD, UE, UF, UG	
SPMWH1228FD★WAUUSC		UU (Mac3 Only)	UU	
SPMWH1228FD★WAUYSC		UY (Y Kitting bin)	UN, UP, UQ, UR, US, UT, UU	
4000	SPMWH1228FD★WAT0SC	T0 (Whole bin)	T1, T2, T3, T4, T5, T6, T7, T8,T9, TA, TB, TC, TD, TE, TF, TG	
	SPMWH1228FD★WATMSC	TM (Quarter bin)	T6, T7, TA, TB	
	SPMWH1228FD★WATKSC	TK (K Kitting bin)	T1, T2, T3, T4, T5, T6, T7, T8,T9, TA, TB, TC, TD, TE, TF, TG	
	SPMWH1228FD★WATUSC	TU (Mac3 Only)	TU	
	SPMWH1228FD★WATYSC	TY (Y Kitting bin)	TN, TP, TQ, TR, TS, TT, TU	
5000	SPMWH1228FD★WAR0SC	R0 (Whole bin)	R1, R2, R3, R4, R5, R6, R7, R8, R9RA,RB,RC,RD,RE,RF,RG	
	SPMWH1228FD★WARMSC	RM (Quarter bin)	R6, R7, RA, RB	
	SPMWH1228FD★WARKSC	RK (K Kitting bin)	R1, R2, R3, R4, R5, R6, R7, R8, R9RA,RB,RC,RD,RE,RF,RG	
	SPMWH1228FD★WARUSC	RU (Mac3 Only)	RU	
	SPMWH1228FD★WARYSC	RY (Y Kitting bin)	RN, RP, RQ, RR, RS, RT, RU	
5700	SPMWH1228FD★WAQ0SC	Q0 (Whole bin)	Q1, Q2, Q3, Q4, Q5, Q6, Q7, Q8, Q9QA,QB,QC,QD,QE,QF,QG	
	SPMWH1228FD★WAQMSC	QM (Quarter bin)	Q6, Q7, QA, QB	
	SPMWH1228FD★WAQKSC	QK (K Kitting bin)	Q1, Q2, Q3, Q4, Q5, Q6, Q7, Q8, Q9QA,QB,QC,QD,QE,QF,QG	
	SPMWH1228FD★WAQUSC	QU (Mac3 Only)	QU	
	SPMWH1228FD★WAQYSC	QY (Y Kitting bin)	QN, QP, QQ, QR, QS, QT, QU	
6500	SPMWH1228FD★WAP0SC	P0 (Whole bin)	P1, P2, P3, P4, P5, P6, P7, P8, P9PA,PB,PC,PD,PE,PF,PG	
	SPMWH1228FD★WAPMSC	PM (Quarter bin)	P6, P7, PA, PB	
	SPMWH1228FD★WAPKSC	PK (K Kitting bin)	P1, P2, P3, P4, P5, P6, P7, P8, P9PA,PB,PC,PD,PE,PF,PG	
	SPMWH1228FD★WAPUSC	PU (Mac3 Only)	PU	
	SPMWH1228FD★WAPYSC	PY (Y Kitting bin)	PN, PP, PQ, PR, PS, PT, PU	

**Note:** "★" can be "5" (Ra80) or "7" (Ra90)

d) Voltage Bins ( $I_F = 150 \text{ mA}$ ,  $T_a = 25 \text{ °C}$ )

CRI (Ra) Min.	Nominal CCT (K)	Product Code	Voltage Rank	Voltage Bin	Voltage Range (V)
-	-	-		A1	2.8 ~ 2.9
			WA	A2	2.9 ~ 3.0
			or		
			WK	A3	3.0 ~ 3.1
				A4	3.1 ~ 3.2
-	-	-		A1	2.8 ~ 2.9
			WN	A1	2.8 ~ 2.9
			or		
			WM	A2	2.9 ~ 3.0

e) Chromaticity Region & Coordinates for whole bin or quarter bin or K kitting bin ( $I_f = 150 \text{ mA}$ ,  $T_a = 25 \text{ }^\circ\text{C}$ )



e) Chromaticity Region & Coordinates

Region	CIE x	CIE y	Region	CIE x	CIE y
<b>W rank (2700 K)</b>					
W1	0.4373	0.3893	W9	0.4465	0.4071
	0.4418	0.3981		0.4513	0.4164
	0.4475	0.3994		0.4573	0.4178
	0.4428	0.3906		0.4523	0.4085
W2	0.4428	0.3906	WA	0.4523	0.4085
	0.4475	0.3994		0.4573	0.4178
	0.4532	0.4008		0.4634	0.4193
	0.4483	0.3919		0.4582	0.4099
W3	0.4483	0.3919	WB	0.4582	0.4099
	0.4532	0.4008		0.4634	0.4193
	0.4589	0.4021		0.4695	0.4207
	0.4538	0.3931		0.4641	0.4112
W4	0.4538	0.3931	WC	0.4641	0.4112
	0.4589	0.4021		0.4695	0.4207
	0.4646	0.4034		0.4756	0.4221
	0.4593	0.3944		0.4700	0.4126
W5	0.4418	0.3981	WD	0.4513	0.4164
	0.4465	0.4071		0.4562	0.4260
	0.4523	0.4085		0.4624	0.4274
	0.4475	0.3994		0.4573	0.4178
W6	0.4475	0.3994	WE	0.4573	0.4178
	0.4523	0.4085		0.4624	0.4274
	0.4582	0.4099		0.4687	0.4289
	0.4532	0.4008		0.4634	0.4193
W7	0.4532	0.4008	WF	0.4634	0.4193
	0.4582	0.4099		0.4687	0.4289
	0.4641	0.4112		0.4750	0.4304
	0.4589	0.4021		0.4695	0.4207
W8	0.4589	0.4021	WG	0.4695	0.4207
	0.4641	0.4112		0.4750	0.4304
	0.4700	0.4126		0.4813	0.4319
	0.4646	0.4034		0.4756	0.4221

Region	CIE x	CIE y	Region	CIE x	CIE y
<b>V rank (3000 K)</b>					
V1	0.4147	0.3814	V9	0.4221	0.3984
	0.4183	0.3898		0.4259	0.4073
	0.4242	0.3919		0.4322	0.4096
	0.4203	0.3833		0.4281	0.4006
V2	0.4203	0.3833	VA	0.4281	0.4006
	0.4242	0.3919		0.4322	0.4096
	0.4300	0.3939		0.4385	0.4119
	0.4259	0.3853		0.4342	0.4028
V3	0.4259	0.3853	VB	0.4342	0.4028
	0.4300	0.3939		0.4385	0.4119
	0.4359	0.3960		0.4449	0.4141
	0.4316	0.3873		0.4403	0.4049
V4	0.4316	0.3873	VC	0.4403	0.4049
	0.4359	0.3960		0.4449	0.4141
	0.4418	0.3981		0.4513	0.4164
	0.4373	0.3893		0.4465	0.4071
V5	0.4183	0.3898	VD	0.4259	0.4073
	0.4221	0.3984		0.4299	0.4165
	0.4281	0.4006		0.4364	0.4188
	0.4242	0.3919		0.4322	0.4096
V6	0.4242	0.3919	VE	0.4322	0.4096
	0.4281	0.4006		0.4364	0.4188
	0.4342	0.4028		0.4430	0.4212
	0.4300	0.3939		0.4385	0.4119
V7	0.4300	0.3939	VF	0.4385	0.4119
	0.4342	0.4028		0.4430	0.4212
	0.4403	0.4049		0.4496	0.4236
	0.4359	0.3960		0.4449	0.4141
V8	0.4359	0.3960	VG	0.4449	0.4141
	0.4403	0.4049		0.4496	0.4236
	0.4465	0.4071		0.4562	0.4260
	0.4418	0.3981		0.4513	0.4164

## e) Chromaticity Region &amp; Coordinates

Region	CIE x	CIE y	Region	CIE x	CIE y
<b>U rank (3500 K)</b>					
U1	0.3889	0.3690	U9	0.3941	0.3848
	0.3915	0.3768		0.3968	0.3930
	0.3981	0.3800		0.4040	0.3966
	0.3953	0.3720		0.4010	0.3882
U2	0.3953	0.3720	UA	0.4010	0.3882
	0.3981	0.3800		0.4040	0.3966
	0.4048	0.3832		0.4113	0.4001
	0.4017	0.3751		0.4080	0.3916
U3	0.4017	0.3751	UB	0.4080	0.3916
	0.4048	0.3832		0.4113	0.4001
	0.4116	0.3865		0.4186	0.4037
	0.4082	0.3782		0.4150	0.3950
U4	0.4082	0.3782	UC	0.4150	0.3950
	0.4116	0.3865		0.4186	0.4037
	0.4183	0.3898		0.4259	0.4073
	0.4147	0.3814		0.4221	0.3984
U5	0.3915	0.3768	UD	0.3968	0.3930
	0.3941	0.3848		0.3996	0.4015
	0.4010	0.3882		0.4071	0.4052
	0.3981	0.3800		0.4040	0.3966
U6	0.3981	0.3800	UE	0.4040	0.3966
	0.4010	0.3882		0.4071	0.4052
	0.4080	0.3916		0.4146	0.4089
	0.4048	0.3832		0.4113	0.4001
U7	0.4048	0.3832	UF	0.4113	0.4001
	0.4080	0.3916		0.4146	0.4089
	0.4150	0.3950		0.4222	0.4127
	0.4116	0.3865		0.4186	0.4037
U8	0.4116	0.3865	UG	0.4186	0.4037
	0.4150	0.3950		0.4222	0.4127
	0.4221	0.3984		0.4299	0.4165
	0.4183	0.3898		0.4259	0.4073

Region	CIE x	CIE y	Region	CIE x	CIE y
<b>T rank (4000 K)</b>					
T1	0.3670	0.3578	T9	0.3702	0.3722
	0.3726	0.3612		0.3763	0.3760
	0.3744	0.3685		0.3782	0.3837
	0.3686	0.3649		0.3719	0.3797
T2	0.3726	0.3612	TA	0.3763	0.3760
	0.3783	0.3646		0.3825	0.3798
	0.3804	0.3721		0.3847	0.3877
	0.3744	0.3685		0.3782	0.3837
T3	0.3783	0.3646	TB	0.3825	0.3798
	0.3840	0.3681		0.3887	0.3836
	0.3863	0.3758		0.3912	0.3917
	0.3804	0.3721		0.3847	0.3877
T4	0.3840	0.3681	TC	0.3887	0.3837
	0.3898	0.3716		0.3950	0.3875
	0.3924	0.3794		0.3978	0.3958
	0.3863	0.3758		0.3912	0.3917
T5	0.3686	0.3649	TD	0.3719	0.3797
	0.3744	0.3685		0.3782	0.3837
	0.3763	0.3760		0.3802	0.3916
	0.3702	0.3722		0.3736	0.3874
T6	0.3744	0.3685	TE	0.3782	0.3837
	0.3804	0.3721		0.3847	0.3877
	0.3825	0.3798		0.3869	0.3958
	0.3763	0.3760		0.3802	0.3916
T7	0.3804	0.3721	TF	0.3847	0.3877
	0.3863	0.3758		0.3912	0.3917
	0.3887	0.3836		0.3937	0.4001
	0.3825	0.3798		0.3869	0.3958
T8	0.3863	0.3758	TG	0.3912	0.3917
	0.3924	0.3794		0.3978	0.3958
	0.3950	0.3875		0.4006	0.4044
	0.3887	0.3836		0.3937	0.4001

e) Chromaticity Region & Coordinates

Region	CIE x	CIE y	Region	CIE x	CIE y
<b>R rank (5000 K)</b>					
R1	0.3366	0.3369	R9	0.3374	0.3554
	0.3369	0.3431		0.3371	0.3493
	0.3407	0.3460		0.3411	0.3522
	0.3403	0.3398		0.3415	0.3587
R2	0.3403	0.3398	RA	0.3415	0.3587
	0.3407	0.3460		0.3411	0.3522
	0.3446	0.3491		0.3451	0.3554
	0.3440	0.3427		0.3457	0.3621
R3	0.3446	0.3491	RB	0.3451	0.3554
	0.3440	0.3427		0.3457	0.3621
	0.3477	0.3458		0.3500	0.3655
	0.3485	0.3522		0.3492	0.3587
R4	0.3485	0.3522	RC	0.3492	0.3587
	0.3477	0.3458		0.3500	0.3655
	0.3514	0.3487		0.3542	0.3690
	0.3524	0.3554		0.3533	0.3620
R5	0.3371	0.3493	RD	0.3376	0.3616
	0.3369	0.3431		0.3374	0.3554
	0.3407	0.3460		0.3415	0.3587
	0.3411	0.3522		0.3420	0.3652
R6	0.3407	0.3460	RE	0.3415	0.3587
	0.3411	0.3522		0.3420	0.3652
	0.3451	0.3554		0.3463	0.3687
	0.3446	0.3491		0.3457	0.3621
R7	0.3446	0.3491	RF	0.3457	0.3621
	0.3451	0.3554		0.3463	0.3687
	0.3492	0.3587		0.3507	0.3724
	0.3485	0.3522		0.3500	0.3655
R8	0.3485	0.3522	RG	0.3500	0.3655
	0.3492	0.3587		0.3507	0.3724
	0.3533	0.3620		0.3551	0.3760
	0.3524	0.3554		0.3542	0.3690

Region	CIE x	CIE y	Region	CIE x	CIE y
<b>Q rank (5700 K)</b>					
Q1	0.3218	0.3298	Q9	0.3211	0.3407
	0.3222	0.3243		0.3215	0.3353
	0.3258	0.3275		0.3254	0.3388
	0.3256	0.3331		0.3252	0.3444
Q2	0.3256	0.3331	QA	0.3252	0.3444
	0.3258	0.3275		0.3254	0.3388
	0.3294	0.3306		0.3293	0.3423
	0.3294	0.3364		0.3293	0.3481
Q3	0.3294	0.3364	QB	0.3293	0.3481
	0.3294	0.3306		0.3293	0.3423
	0.3330	0.3338		0.3332	0.3458
	0.3331	0.3398		0.3333	0.3518
Q4	0.3331	0.3398	QC	0.3333	0.3518
	0.3330	0.3338		0.3332	0.3458
	0.3366	0.3369		0.3371	0.3493
	0.3369	0.3431		0.3374	0.3554
Q5	0.3215	0.3353	QD	0.3207	0.3462
	0.3218	0.3298		0.3211	0.3407
	0.3256	0.3331		0.3252	0.3444
	0.3254	0.3388		0.3250	0.3501
Q6	0.3254	0.3388	QE	0.3250	0.3501
	0.3256	0.3331		0.3252	0.3444
	0.3294	0.3364		0.3293	0.3481
	0.3293	0.3423		0.3292	0.3539
Q7	0.3293	0.3423	QF	0.3292	0.3539
	0.3294	0.3364		0.3293	0.3481
	0.3331	0.3398		0.3333	0.3518
	0.3332	0.3458		0.3334	0.3578
Q8	0.3332	0.3458	QG	0.3334	0.3578
	0.3331	0.3398		0.3333	0.3518
	0.3369	0.3431		0.3374	0.3554
	0.3371	0.3493		0.3376	0.3616

## e) Chromaticity Region &amp; Coordinates

Region	CIE x	CIE y	Region	CIE x	CIE y
<b>P rank (6500 K)</b>					
P1	0.3068	0.3113	P9	0.3048	0.3207
	0.3106	0.3150		0.3089	0.3249
	0.3098	0.3199		0.3080	0.3298
	0.3058	0.3160		0.3038	0.3256
P2	0.3106	0.3150	PA	0.3089	0.3249
	0.3144	0.3186		0.313	0.3290
	0.3137	0.3238		0.3123	0.3341
	0.3098	0.3199		0.3080	0.3298
P3	0.3144	0.3186	PB	0.3130	0.3290
	0.3183	0.3224		0.3172	0.3332
	0.3177	0.3278		0.3166	0.3384
	0.3137	0.3238		0.3123	0.3341
P4	0.3183	0.3224	PC	0.3172	0.3332
	0.3221	0.3261		0.3214	0.3373
	0.3218	0.3317		0.3210	0.3427
	0.3177	0.3278		0.3166	0.3384
P5	0.3058	0.3160	PD	0.3038	0.3256
	0.3098	0.3199		0.3080	0.3298
	0.3089	0.3249		0.3072	0.3348
	0.3048	0.3207		0.3028	0.3304
P6	0.3098	0.3199	PE	0.3080	0.3298
	0.3137	0.3238		0.3123	0.3341
	0.3130	0.3290		0.3115	0.3391
	0.3089	0.3249		0.3072	0.3348
P7	0.3137	0.3238	PF	0.3123	0.3341
	0.3177	0.3278		0.3166	0.3384
	0.3172	0.3332		0.3160	0.3436
	0.313	0.3290		0.3115	0.3391
P8	0.3177	0.3278	PG	0.3166	0.3384
	0.3218	0.3317		0.3210	0.3427
	0.3214	0.3373		0.3206	0.3481
	0.3172	0.3332		0.3160	0.3436

**Note:** Samsung maintains measurement tolerance of: Cx, Cy =  $\pm 0.005$

f) Chromaticity Region & Coordinates for Y kitting bin or mac3 only bin ( $I_F = 150 \text{ mA}$ ,  $T_a = 25 \text{ }^\circ\text{C}$ )

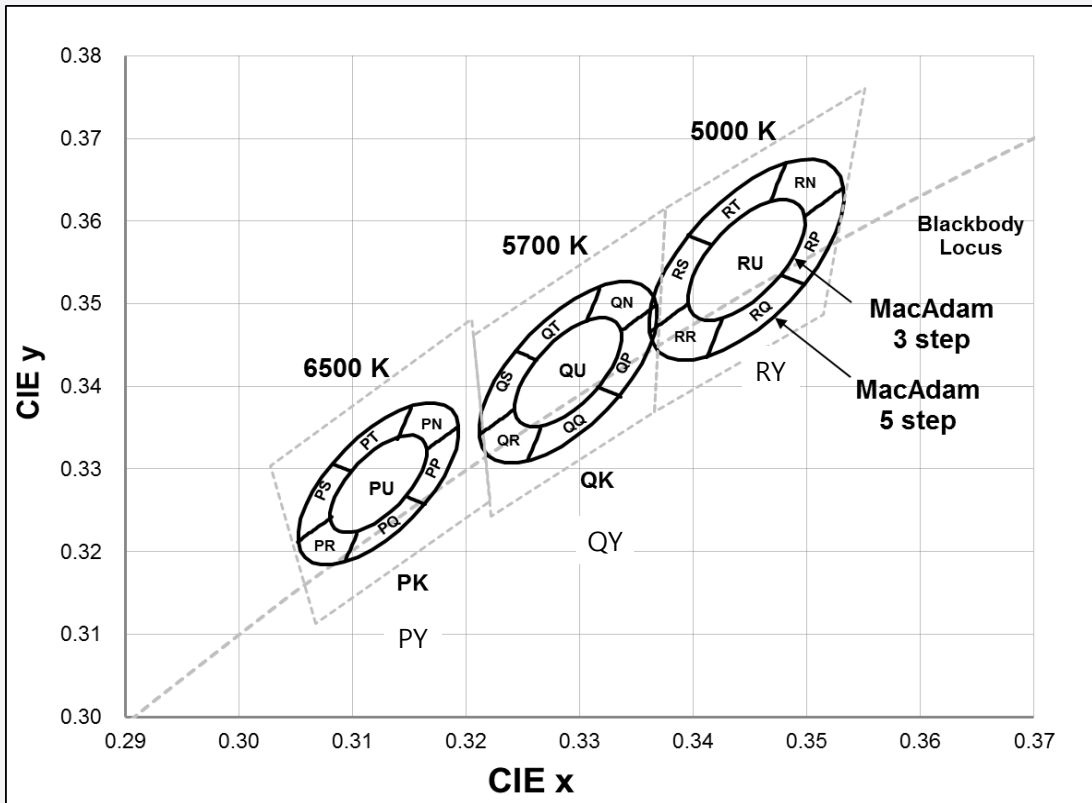

## f) Chromaticity Region &amp; Coordinates



MacAdam	CCT (K)	Center point		Major-axis	Minor-axis	Rotation
		CIE x	CIE y	a	b	Φ
3 step	2700	0.4578	0.4101	0.0081	0.0042	53.70
	3000	0.4338	0.4030	0.0083	0.0041	53.22
	3500	0.4073	0.3917	0.0093	0.0041	54.00
	4000	0.3818	0.3797	0.0094	0.0040	53.72
	5000	0.3447	0.3553	0.0082	0.0035	59.62
	5700	0.3287	0.3417	0.0075	0.0032	59.10
	6500	0.3123	0.3282	0.0067	0.0029	58.57
5 step	2700	0.4578	0.4101	0.0135	0.0070	53.70
	3000	0.4338	0.4030	0.0138	0.0068	53.22
	3500	0.4073	0.3917	0.0155	0.0068	54.00
	4000	0.3818	0.3797	0.0157	0.0067	53.72
	5000	0.3447	0.3553	0.0137	0.0058	59.62
	5700	0.3287	0.3417	0.0125	0.0053	59.10
	6500	0.3123	0.3282	0.0112	0.0048	58.57

**Note:** Samsung maintains measurement tolerance of:  $C_x, C_y = \pm 0.005$

f) Chromaticity Region & Coordinates



CCT	Region	CIE x	CIE y	CCT	Region	CIE x	CIE y	CCT	Region	CIE x	CIE y
2700K	1	0.4521	0.4142	3000K	1	0.4283	0.4071	3500K	1	0.4018	0.3957
	2	0.4619	0.4216		2	0.4382	0.4146		2	0.4125	0.4046
	3	0.4675	0.4175		3	0.4437	0.4105		3	0.418	0.4005
	4	0.4634	0.4059		4	0.4393	0.3989		4	0.4128	0.3877
	5	0.4537	0.3986		5	0.4293	0.3913		5	0.4022	0.3788
	6	0.4481	0.4028		6	0.4239	0.3954		6	0.3966	0.3828
	7	0.4544	0.4126		7	0.4305	0.4054		7	0.404	0.3941
	8	0.4603	0.417		8	0.4364	0.41		8	0.4104	0.3994
	9	0.4636	0.4145		9	0.4397	0.4075		9	0.4137	0.397
	10	0.4612	0.4076		10	0.4371	0.4005		10	0.4106	0.3893
	11	0.4553	0.4032		11	0.4311	0.396		11	0.4042	0.384
	12	0.452	0.4057		12	0.4279	0.3984		12	0.4009	0.3864
4000K	1	0.3764	0.3837	5000K	1	0.3397	0.3583	5700K	1	0.3242	0.3445
	2	0.3871	0.3926		2	0.3482	0.367		2	0.332	0.3524
	3	0.3925	0.3887		3	0.3532	0.364		3	0.3365	0.3496
	4	0.3872	0.3758		4	0.3497	0.3524		4	0.3333	0.339
	5	0.3765	0.3668		5	0.3412	0.3436		5	0.3254	0.331
	6	0.3711	0.3707		6	0.3362	0.3465		6	0.3209	0.3338
	7	0.3786	0.3821		7	0.3417	0.3571		7	0.326	0.3434
	8	0.385	0.3874		8	0.3468	0.3623		8	0.3307	0.3481
	9	0.3882	0.3851		9	0.3498	0.3605		9	0.3334	0.3464
	10	0.385	0.3773		10	0.3477	0.3535		10	0.3314	0.3401
	11	0.3786	0.372		11	0.3426	0.3483		11	0.3267	0.3353
	12	0.3754	0.3743		12	0.3396	0.35		12	0.324	0.3369

### f) Chromaticity Region & Coordinates

CCT	Region	CIE x	CIE y
6500K	1	0.3082	0.3307
	2	0.3153	0.3377
	3	0.3194	0.3352
	4	0.3164	0.3257
	5	0.3093	0.3187
	6	0.3052	0.3212
	7	0.3098	0.3297
	8	0.3141	0.3339
	9	0.3166	0.3324
	10	0.3148	0.3267
	11	0.3105	0.3225
	12	0.308	0.324

**Note:** Samsung maintains measurement tolerance of:  $C_x, C_y = \pm 0.005$

### 3. Typical Characteristics Graphs

#### a) Spectrum Distribution ( $I_f = 150 \text{ mA}$ , $T_a = 25 \text{ }^\circ\text{C}$ )

CCT: 2700 K (80 CRI)



CCT: 3000 K (80 CRI)



CCT: 3500 K (80 CRI)



CCT: 4000 K (80 CRI)



CCT: 5000 K (80 CRI)



CCT: 5700 K (80 CRI)



CT: 6500 K (80 CRI)



CCT: 2700 K (90 CRI)



CCT: 3000 K (90 CRI)



CCT: 3500 K (90 CRI)



CCT: 4000 K (90 CRI)



CCT: 5000 K (90 CRI)



CCT: 5700 K (90 CRI)



CCT: 6500 K (90 CRI)



**b) Forward Current Characteristics ( $T_a = 25\text{ }^\circ\text{C}$ )**



c) Temperature Characteristics ( $I_F = 150 \text{ mA}$ )

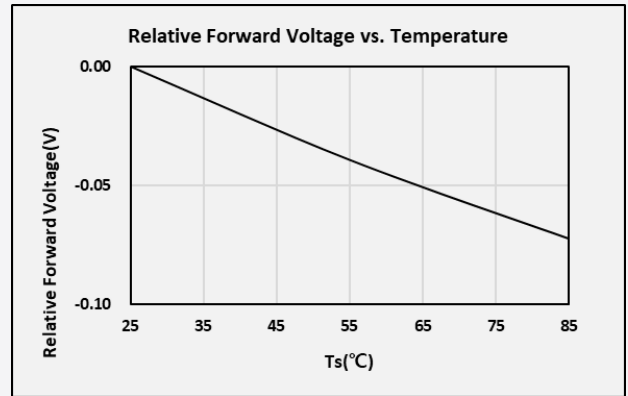
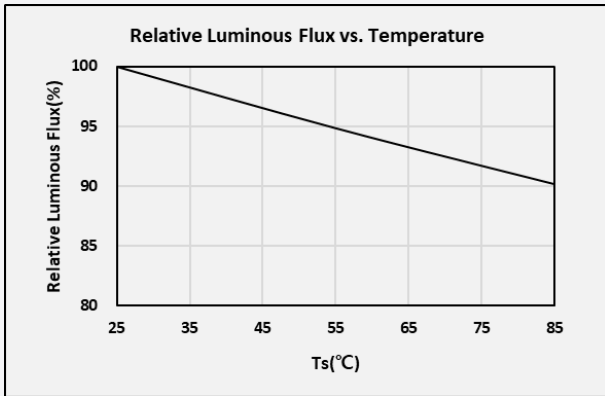

d) Color Shift Characteristics

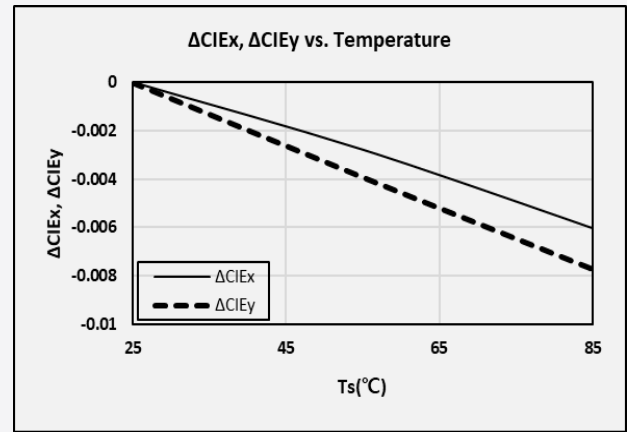

e) Derating Curve

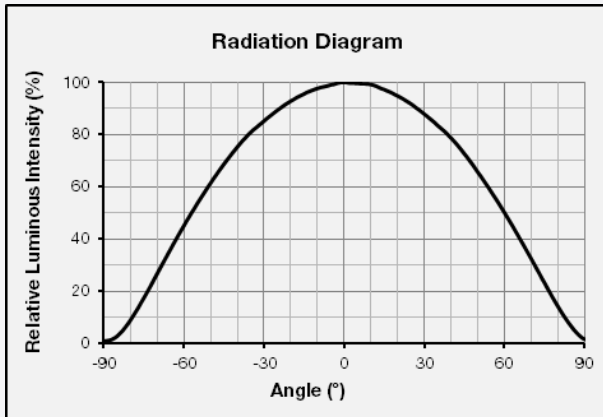

**f) Beam Angle Characteristics ( $I_F = 150 \text{ mA}$ ,  $T_a = 25 \text{ }^\circ\text{C}$ )**

#### 4. Outline Drawing & Dimension



#### Notes:

- 1)  $T_s$  point and measurement method:
  - ① Measure one point at the cathode pad, if necessary remove PSR of PCB to reach  $T_s$  point.
  - ② All pads must be soldered to the PCB to dissipate heat properly, otherwise the LED can be damaged.

#### Precautions:

- 1) Pressure on the LEDs will influence to the reliability of the LEDs. Precautions should be taken to avoid strong pressure on the LEDs. Do not put stress on the LEDs during heating.
- 2) Re-soldering should not be done after the LEDs have been soldered. If re-soldering is unavoidable, LED's characteristics should be carefully checked before and after such repair.
- 3) Do not stack assembled PCBs together. Since materials of LEDs is soft, abrasion between two PCB assembled with LED might cause catastrophic failure of the LEDs.

## 5. Reliability Test Items & Conditions

### a) Test Items

Test Item	Test Condition	Test Hour / Cycle	Sample No.
Room Temperature Life Test	25 °C, DC Max Current	1000 h	22
High Temperature Life Test	85 °C, DC Max Current	1000 h	22
High Temperature Humidity Life Test	60 °C, 90 % RH DC 150mA	1000 h	22
Low Temperature Life Test	-40 °C, DC Max Current	1000 h	22
Powered Temperature Cycle Test	-45 °C ~ 85 °C, each 20 min, on/off 5 min Temp. Change time 100min, DC Max Current	100 cycles	22
Temperature Cycle	-45°C / 15 min ↔ 125 °C / 15 min	200 cycles	100
High Temperature Storage	85 °C	1000 h	11
Low Temperature Storage	-40 °C	1000 h	11
ESD (HBM)	 <p>           R<sub>1</sub>: 10 MΩ            R<sub>2</sub>: 1.5 kΩ            C: 100 pF            V: ±2 kV         </p>	5 times	30

### b) Criteria for Judging the Damage

Item	Symbol	Test Condition (T <sub>s</sub> = 25 °C)	Limit	
			Min	Max
Forward Voltage	V <sub>F</sub>	I <sub>F</sub> = 150 mA	Init. Value * 0.9	Init. Value * 1.1
Luminous Flux	Φ <sub>v</sub>	I <sub>F</sub> = 150 mA	Init. Value * 0.7	Init. Value * 1.1

## 6. Soldering Conditions

### a) Reflow Conditions (Pb free)

Reflow frequency: 2 times max.



### b) Manual Soldering Conditions

Not more than 5 seconds @ max. 300 °C, under soldering iron.

## 7. Tape & Reel

### a) Taping Dimension

(unit: mm)



A0	3.10±0.1	P0	4.00±0.1	T	0.20±0.05	D0	1.60(MAX)
B0	3.70±0.1	P1	4.00±0.1	E	1.75±0.1	D1	1.05(MIN)
K0	1.00±0.1	P2	2.00±0.1	F	3.50±0.05	V	8.00±0.1

## b) Reel Dimension (max 4,000 pcs)

(unit: mm)

**Notes:**

- 1) Quantity: The quantity/reel is 4,000 pcs
- 2) All dimensions are millimeters (tolerance :  $\pm 0.2\text{mm}$ )
- 3) Packaging: P/N, Manufacturing data code no. and quantity are indicated on the aluminum packing bag

c) Reel Dimension (max 16,000 pcs)

(unit: mm)



Notes:

- 1) Quantity: The quantity/reel is 16,000 pcs
- 2) All dimensions are millimeters (tolerance : ±0.2mm)
- 3) Packaging: P/N, Manufacturing data code no. and quantity are indicated on the aluminum packing bag

## 8. Label Structure

### a) Label Structure



Note: Denoted bin code and product code above is only an example (see description on page 6)

Bin Code:

- ⒶⒷ: Forward Voltage bin (refer to page 10)
- ⒸⒹ: Chromaticity bin (refer to page 11-18)
- ⒺⒻ: Luminous Flux bin (refer to page 7)

### b) Lot Number

The lot number is composed of the following characters:



①②③④⑤⑥⑦⑧⑨ / ⒶⒷⒸ / 4,000 pcs

- ①② : Production site (GP : Shenzhen, China, G3 : Nanchang, China, GD : Zhongshan, China)
- ③ : Product state (A: Normal, B: Bulk, C: First Production, R: Reproduction, S: Sample)
- ④ : Year (C: 2018, D: 2019, E: 2020, F: 2021, G: 2022...)
- ⑤ : Month (1~9, A, B, C)
- ⑥ : Day (1~9, A, B~V)
- ⑦⑧⑨ ⒶⒷⒸ : Product serial number

## 9. Packing Structure

### a) Packing Process (The quantity of PKG on the Reel to be Max 4,000 pcs)

#### Reel



#### Aluminum Vinyl Packing Bag



#### Outer Box

Material: Paper (SW3B(B))

Type	Size (mm)			Note
	L	W	H	
7 inch L	245 ± 5	220 ± 5	182 ± 5	Up to 10 reels
7 inch S	245 ± 5	220 ± 5	86 ± 5	Up to 5 reels

#### ① Side Label



b) Packing Process (The quantity of PKG on the Reel to be Max 16,000 pcs)

**Reel**

LM281B+ RA80 5000K  
**A3R1SC**  
 SPMWH1228FD5WKR0SC A3R1SC  
 G3ACA4001 / IOAA / 16000 pcs  
 SAMSUNG EREC

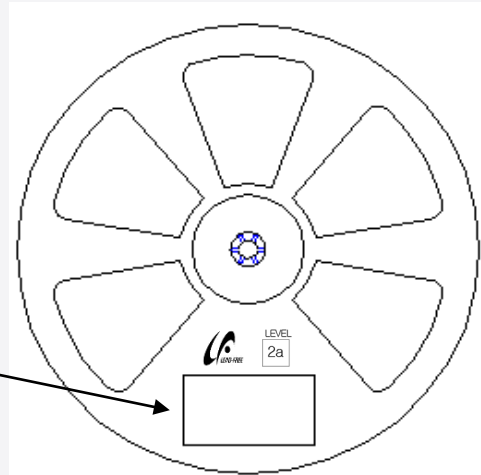

**Aluminum Vinyl Packing Bag**

LM281B+ RA80 5000K  
**A3R1SC**  
 SPMWH1228FD5WKR0SC A3R1SC  
 G3ACA4001 / IOAA / 16000 pcs  
 SAMSUNG EREC

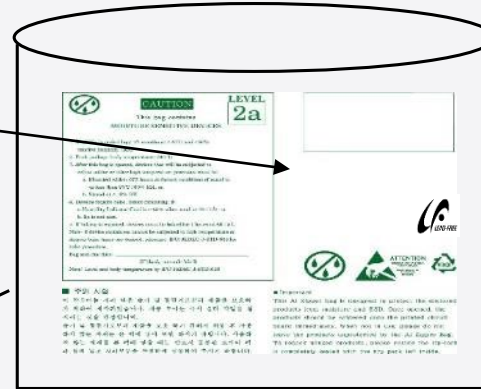

**Outer Box**

LM281B+ RA80 5000K  
**A3R1SC**  
 SPMWH1228FD5WKR0SC A3R1SC  
 G3ACA4001 / IOAA / 480000 pcs  
 SAMSUNG EREC

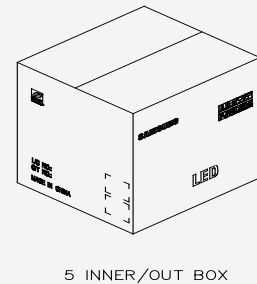
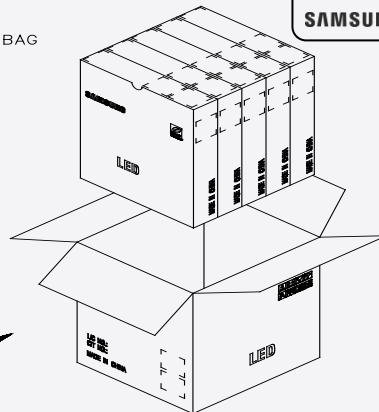
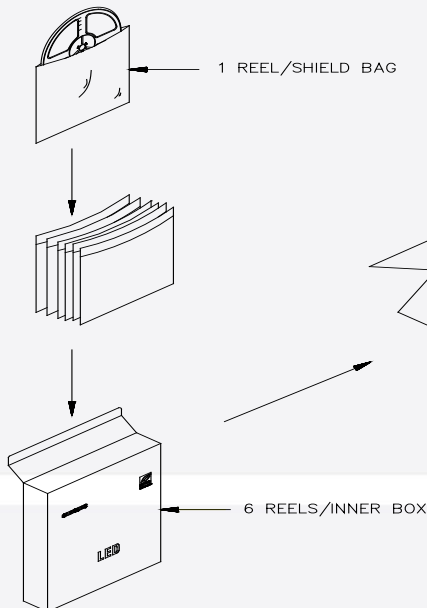

c) Packing Process for kitting (The quantity of PKG on the Reel to be Max 4,000 pcs)

Reel

Kitting 'A'



Kitting 'B'



Aluminum Vinyl Packing Bag

Kitting 'A'



Kitting 'B'



Material: Paper (SW3B(B))

Type	Size (mm)			Note
	L	W	H	
7 inch L	245 ± 5	220 ± 5	182 ± 5	Up to 10 reels

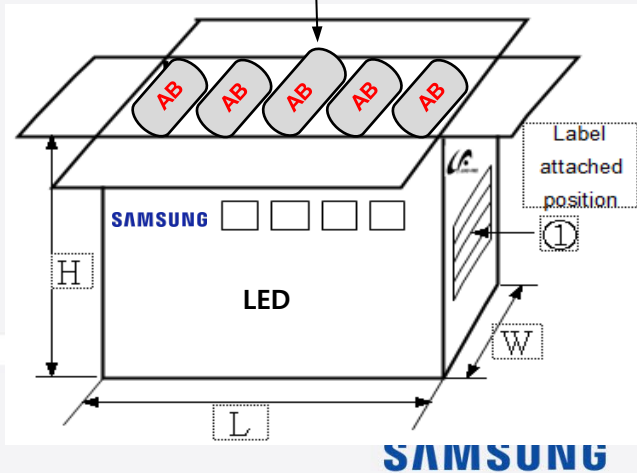

d) Packing Process for kitting (The quantity of PKG on the Reel to be Max 16,000 pcs)

Reel

**Kitting 'A'**

LM281B+ RA80 ★K

**A3★1SC**

SPMWH1228FD5WK★KSC A3★1SC

|||||

G3ACA4001 / I0AA / 16000 pcs

|||||

**Kitting 'B'**

LM281B+ RA80 ★K

**A3★CSC**

SPMWH1228FD5WK★KSC A3★CSC

|||||

G3ACA4001 / I0AA / 16000 pcs

|||||

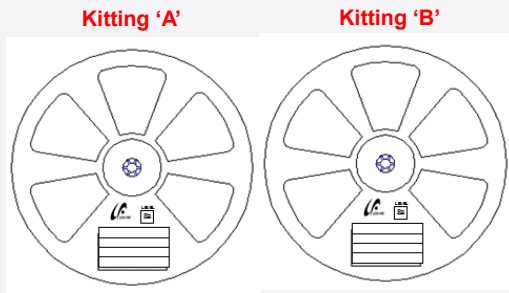

Aluminum Vinyl Packing Bag

**Kitting 'A'**

LM281B+ RA80 ★K

**A3★1SC**

SPMWH1228FD5WK★KSC A3★1SC

|||||

G3ACA4001 / I0AA / 16000 pcs

|||||

**Kitting 'B'**

LM281B+ RA80 ★K

**A3★CSC**

SPMWH1228FD5WK★KSC A3★CSC

|||||

G3ACA4001 / I0AA / 16000 pcs

|||||

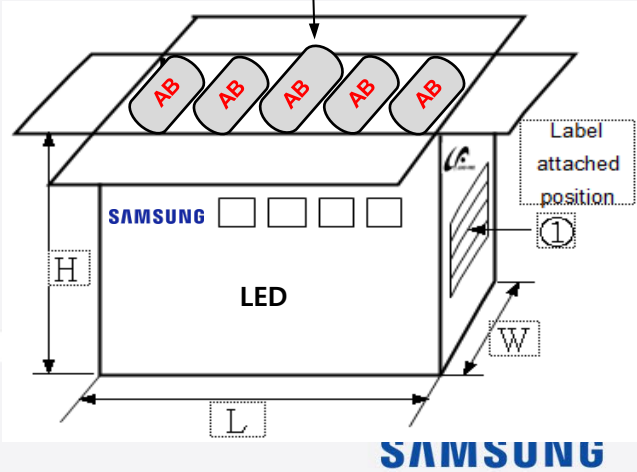
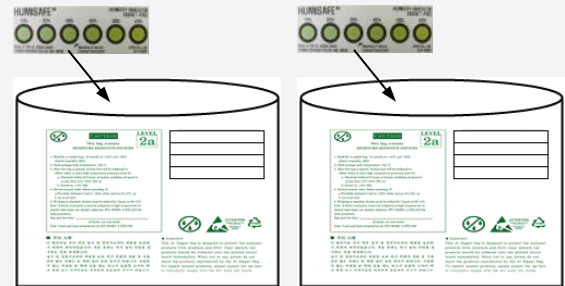

Material: Paper (SW3B(B))

Type	Size (mm)			Note
	L	W	H	
13 inch	378 ± 5	345 ± 5	405 ± 5	Up to 10 reels

e) Aluminum Vinyl Packing Bag



**CAUTION**

This bag contains  
**MOISTURE SENSITIVE DEVICES**

**LEVEL**

2a

LM281B+ RA80 5000K

A3R1SC

SPMWH1228FD5WAR0SC A3R1SC

G3ACA4001 / I0AA / 4000 pcs

SAMSUNG EAC 

1. Shelf life in sealed bag: 12 months at <math>< 40^{\circ}\text{C}</math> and <math>< 90\%</math> relative humidity (RH)

2. Peak package body temperature: 240 °C

3. After this bag is opened, devices that will be subjected to reflow solder or other high temperature processes must be:

- a. Mounted within 672 hours at factory conditions of equal to or less than 30°C / 60% RH, or
- b. Stored at <math>< 10\%</math> RH

4. Devices require bake, before mounting, if:

- a. Humidity Indicator Card is >60% when read at 23±5°C, or
- b. 2a is not met.

5. If baking is required, devices must be baked for 10 ~ 24 hours at 60±5°C

Note: If device containers cannot be subjected to high temperature or shorter bake times are desired, reference IPC/JEDEC J-STD-033 for bake procedure.

Bag seal due date: \_\_\_\_\_  
(If blank, see code label)

Note: Level and body temperature by IPC/JEDEC J-STD-020









**■ 주의 사항**

이 알루미늄 지퍼 백은 습기 및 정전기로부터 제품을 보호하기 위하여 제작되었습니다. 개봉 후에는 즉시 솔더 작업을 실시하는 것을 권장합니다.

습기 및 정전기로부터 제품을 보호 하기 위해서 개봉 후 사용하지 않는 자재는 본 팩에 넣어 보관 하시기 바랍니다. 사용하지 않는 자재를 본 팩에 넣을 때는 반드시 동봉된 드라이 팩과 함께 넣고 지퍼부분을 완전하게 밀봉하여 주시기 바랍니다.

**■ Important**

This Al Zipper bag is designed to protect the enclosed products from moisture and ESD. Once opened, the products should be soldered onto the printed circuit board immediately. When not in use, please do not leave the products unprotected by the Al Zipper Bag. To repack unused products., please ensure the zip-lock is completely sealed with the dry pack left inside.

f) Humidity Indicator Card inside Aluminum Vinyl Bag



## 10. Precautions in Handling & Use

- 1) For over-current protection, users are recommended to apply resistors connected in series with the LEDs to mitigate sudden change of the forward current caused by shift of forward voltage.
- 2) This device should not be used in any type of fluid such as water, oil, organic solvent, etc. When cleaning is required, IPA is recommended as the cleaning agent. Some solvent-based cleaning agent may damage the silicone resins used in the device.
- 3) When the device is in operation, the forward current should be carefully determined considering the maximum ambient temperature and corresponding junction temperature.
- 4) LEDs must be stored in a clean environment.  
(shelf life of sealed bags is 12 months at temperature 0~40 °C, 0~90 % RH).
- 5) After storage bag is opened, device subjected to soldering, solder reflow, or other high temperature processes must be:
  - a. Mounted within 672 hours (28 days) at an assembly line with a condition of no more than 30 °C / 60 % RH\*<sup>Note 1</sup>, or
  - b. Mounted within 24 hours (1 day) at an assembly line with a condition of more than 30 °C / 70 % RH\*<sup>Note 2</sup>, or
  - c. Stored at <10 % RH.

\*Note 1, 2: IPC/JEDEC J-STD-033A, Recommended Equivalent Total Floor Life Table

Package Type and Body Thickness	Moisture Sensitivity Level	Maximum Percent Relative Humidity						Temperature
		40%	50%	60%	70%	80%	90%	
Body Thickness <2.1mm	Level 2a	∞	∞	28	1	1	1	30°C
		∞	∞	∞	2	1	1	25°C
		∞	∞	∞	2	2	1	20°C

- 6) Repack unused devices with anti-moisture packing, fold to close any opening and then store in a dry place.
- 7) Devices require baking before mounting, if humidity card reading is >60 % at 23 ± 5 °C.
- 8) Devices must be baked for 10~24 hours at 60 ± 5 °C, if baking is required.
- 9) The LEDs are sensitive to the static electricity and surge current. It is recommended to use a wrist band or anti-electrostatic glove when handling the LEDs. If voltage exceeding the absolute maximum rating is applied to LEDs, it may cause damage or even destruction to LED devices. Damaged LEDs may show some unusual characteristics such as increase in leakage current, lowered turn-on voltage, or abnormal lighting of LEDs at low current.
- 10) VOCs (Volatile Organic Compounds) can be generated from adhesives, flux, hardener or organic additives used in luminaires (fixtures). Transparent LED silicone encapsulant is permeable to those chemicals and they may lead to a discoloration of encapsulant when they exposed to heat or light. This phenomenon can cause a significant loss of light emitted (output) from the luminaires. In order to prevent these problems, we recommend users to know the physical properties of materials used in luminaires and they must be carefully selected.
- 11) Risk of sulfurization (or tarnishing)  
The LED from Samsung uses a silver-plated lead frame and its surface color may change to black (or dark colored) when it is exposed to sulfur (S), chlorine (Cl) or other halogen compound. Sulfurization of lead frame may cause intensity degradation, change of chromaticity coordinates and, in extreme cases, open circuit. It requires caution. Due to possible sulfurization of lead frame, LED should not be used and stored together with oxidizing substances made of materials such as rubber, plain paper, lead solder cream, etc.

# Legal and additional information.

## [About Samsung Electronics Co., Ltd.](#)

Samsung inspires the world and shapes the future with transformative ideas and technologies. The company is redefining the worlds of TVs, smartphones, wearable devices, tablets, digital appliances, network systems, and memory, system LSI, foundry and LED solutions. For the latest news, please visit the Samsung Newsroom at [news.samsung.com](https://news.samsung.com).

Samsung provides limited warranty for its LED products, the full text of which is available at <https://www.samsung.com/led/support/warranties>

Copyright © 2022 Samsung Electronics Co., Ltd. All rights reserved.

Samsung is a registered trademark of Samsung Electronics Co., Ltd.

Specifications and designs are subject to change without notice. Non-metric weights and measurements are approximate. All data were deemed correct at time of creation. Samsung is not liable for errors or omissions. All brand, product, service names and logos are trademarks and/or registered trademarks of their respective owners and are hereby recognized and acknowledged.

Samsung Electronics Co., Ltd.  
95, Samsung 2-ro  
Giheung-gu  
Yongin-si, Gyeonggi-do, 446-711  
KOREA

[www.samsungled.com](http://www.samsungled.com)

**SAMSUNG**

## Looking for pricing, stock, or lifecycle information?

Click below to explore more details on WIN SOURCE:

- ⊖ [View SPMWH1228FD7WAQ0SC on WIN SOURCE](#)
- ⊖ [Samsung Information](#)

## Optimize Your Supply Chain with WIN SOURCE Solutions

- ✓ Global Sourcing Solution
- ✓ Obsolete Management
- ✓ Cost Control Management
- ✓ Shortage Management
- ✓ Alternative Solution
- ✓ Excess Inventory Management