



**THE DATASHEET OF
SPMWH3228FD5WAPMSA**



Middle Power LED Series
2835 0.5W Room Temp Zener In

LM281BZ+
RKrank



Designed for better lm/\$ (Ambient, Linear)

Features & Benefits

- 0.5W Class mid power LED
- Standard form factor for design flexibility (2.8 × 3.5 mm)



Table of Contents

1.	Characteristics	-----	3
2.	Product Code Information	-----	6
3.	Typical Characteristics Graphs	-----	21
4.	Outline Drawing & Dimension	-----	26
5.	Reliability Test Items & Conditions	-----	27
6.	Soldering Conditions	-----	28
7.	Tape & Reel	-----	29
8.	Label Structure	-----	32
9.	Packing Structure	-----	33
10.	Precautions in Handling & Use	-----	37

1. Characteristics

a) Absolute Maximum Rating

Item	Symbol	Rating	Unit	Condition
Ambient / Operating Temperature	T_a	-40 ~ +85	°C	-
Storage Temperature	T_{stg}	-40 ~ +85	°C	-
LED Junction Temperature	T_j	115	°C	-
Forward Current	I_F	200	mA	-
Peak Pulsed Forward Current	I_{FP}	300	mA	Duty 1/10, pulse width 10ms
Assembly Process Temperature	-	260 <10	°C s	-
ESD (HBM)	-	5	kV	-

Note:

Proper current derating must be observed to maintain junction temperature below the maximum at all time.

It is recommended minimum current 10mA in order to avoid un-even brightness, and may vary depending on circuit configuration.

b) Electro-optical Characteristics (I_F = 65 mA, T_s = 25 °C)

Item	Unit	Rank	Bin	Min.	Typ.	Max.
Forward Voltage (VF)	V	WA or WK WN or WM	AY	2.6		2.7
			AZ	2.7		2.8
			A1	2.8		2.9
			A2	2.9		3.0
			AY	2.6		2.7
			AZ	2.7		2.8
Color Rendering Index (Ra)	-	5 7		80	-	-
				90		
Special CRI (R9)	For Ra 90			50		
Thermal Resistance (junction to solder point)	°C/W			-	25	-
Beam Angle	°			-	120	-

Note:

Samsung maintains measurement tolerance of: forward voltage = ±0.1 V, CRI = ±3, R9 = ±6.5

c) Electro-optical Characteristics (I_F = 65 mA, T_s = 25 °C)

Item	CRI (R _a) Min.	Nominal CCT (K)	Bin	150mA	
				Min.	Max.
Luminous Flux (φ _v)	80	2700	RK	32.0	34.0
		3000	RK	32.5	34.5
		3500	RK	33.0	35.0
		4000	RK	34.0	36.0
		5000	RK	35.0	37.0
		5700	RK	34.5	36.5
		6500	RK	34.0	36.0
	90	2700	RK	27.0	29.0
		3000	RK	28.0	30.0
		3500	RK	29.0	31.0
		4000	RK	30.0	32.0
		5000	RK	30.5	32.5
		5700	RK	30.0	32.0
		6500	RK	30.0	32.0

Note:

Samsung maintains measurement tolerance of: forward voltage = ±0.1V, luminous flux = ±5 %, CRI = ±3

2. Product Code Information

1	2	3	4	5	6	7	8	9	10	11	12	13	14	15	16	17	18
S	P	M	W	H	3	2	2	8	M	D	5	W	A	R	0	R	K

Digit	PKG Information	Code	Specification			
1 2 3	Samsung Package Middle Power	SPM	Middle power			
4 5	Color	WH	White			
6	Product Version	3	Zener - in			
7 8 9	Form Factor	228	2.8 x 3.5 x 0.7 mm; 2 pads			
10	Sorting Current (mA)	M	65 mA			
11	Chromaticity Coordinates	D	ANSI Standard			
12	CRI	5	Min. 80			
		7	Min. 90			
13 14	Forward Voltage (V)	WA or WK	2.6~3.0	Bin code	AY	2.6 ~ 2.7
					AZ	2.7 ~ 2.8
		A1	2.8 ~ 2.9			
		A2	2.9 ~ 3.0			
WA : 4,000ea per reel ,WK : 16,000ea per reel						
WN or WM	2.6~2.8	Bin code	AY	2.6 ~ 2.7		
			AZ	2.7 ~ 2.8		
WN : 4,000ea per reel ,WM : 16,000ea per reel						
15 16	CCT (K)	W☆	2700	Bin Code:	W1, W2, W3, W4, W5, W6, W7, W8, W9, WA, WB, WC, WD, WE, WF, WG, WN, WP, WQ, WR, WS, WT, WU	
		V☆	3000		V1, V2, V3, V4, V5, V6, V7, V8, V9, VA, VB, VC, VD, VE, VF, VG, VN, VP, VQ, VR, VS, VT, VU	
		U☆	3500		U1, U2, U3, U4, U5, U6, U7, U8, U9, UA, UB, UC, UD, UE, UF, UG, UN, UP, UQ, UR, US, UT, UU	
		T☆	4000		T1, T2, T3, T4, T5, T6, T7, T8, T9, TA, TB, TC, TD, TE, TF, TG, TN, TP, TQ, TR, TS, TT, TU	
		R☆	5000		R1, R2, R3, R4, R5, R6, R7, R8, R9,RA, RB, RC, RD, RE, RF, RG, RN, RP, RQ, RR, RS, RT, RU	
		Q☆	5700		Q1, Q2, Q3, Q4, Q5, Q6, Q7, Q8, Q9,QA, QB, QC, QD, QE, QF, QG, QN, QP, QQ, QR, QS, QT, QU	
		P☆	6500		P1, P2, P3, P4, P5, P6, P7, P8, P9,PA, PB, PC, PD, PE, PF, PG, PN, PP, PQ, PR, PS, PT, PU	
☆ : "0" (Whole bin), "M" (Quarter bin), "K" (K Kitting bin), "Y"(Y Kitting bin) or "U" (Mac3 only)						
17 18	Luminous Flux	RK	Bin Code	RK		

a) Luminous Flux Bins ($I_f = 65 \text{ mA}$, $T_s = 25^\circ\text{C}$)

CRI (R_a) Min	Nominal CCT (K)	Product Code	Flux Bin	Flux Range (ϕ_{v} , lm)
80	2700	SPMWH3228MD5WAW☆RK	RK	32.0 ~ 34.0
	3000	SPMWH3228MD5WAV☆RK	RK	32.5 ~ 34.5
	3500	SPMWH3228MD5WAU☆RK	RK	33.0 ~ 35.0
	4000	SPMWH3228MD5WAT☆RK	RK	34.0 ~ 36.0
	5000	SPMWH3228MD5WAR☆RK	RK	35.0 ~ 37.0
	5700	SPMWH3228MD5WAQ☆RK	RK	34.5 ~ 36.5
	6500	SPMWH3228MD5WAP☆RK	RK	34.0 ~ 36.0
	90	2700	SPMWH3228MD7WAW☆RK	RK
3000		SPMWH3228MD7WAV☆RK	RK	28.0 ~ 30.0
3500		SPMWH3228MD7WAU☆RK	RK	29.0 ~ 31.0
4000		SPMWH3228MD7WAT☆RK	RK	30.0 ~ 32.0
5000		SPMWH3228MD7WAR☆RK	RK	30.5 ~ 32.5
5700		SPMWH3228MD7WAQ☆RK	RK	30.0 ~ 32.0
6500		SPMWH3228MD7WAP☆RK	RK	30.0 ~ 32.0

Note:

"☆" can be "0" (Whole bin), "M" (Quarter bin), "K" (K Kitting bin), "Y" (Y Kitting bin) or "U" (Mac3 only) of the color binning

b) Kitting rule

1) K Kitting bin Concept

1. Under agreement between customer and SAMSUNG ELECTRONICS, SAMSUNG can supply kitting bin (VF, Color, Im).
2. A forward voltage (VF) of kitting bin is combined by a pair of same VF rank such as (AY+AY), (AZ+AZ), (A1+A1) or (A2+A2)
3. A Chromaticity Coordinates of kitting bin is mixed by kitting procedure.(below kitting simulation)

[Kitting example]

D	E	F	G
9	A	B	C
5	6	7	8
1	2	3	4

[Binning Information]

	Bin #1	Bin #2
VF	AY	AY
	AZ	AZ
	A1	A1
	A2	A2
CIE	1, 2, 5 bin	C, F, G bin
	6, 7, A, B bin	6, 7, A, B bin
	3, 4, 8 bin	9, D, E bin

2) Y Kitting bin Concept

1. Under agreement between customer and SAMSUNG ELECTRONICS, SAMSUNG can supply kitting bin (VF, Color, Im).
2. A forward voltage (VF) of kitting bin is combined by a pair of same VF rank such as (AY+AY), (AZ+AZ), (A1+A1) or (A2+A2)
3. A Chromaticity Coordinates of kitting bin is mixed by kitting procedure.(below kitting simulation)

[Kitting example]



[Binning Information]

		Bin #1	Bin #2
VF		AY	AY
		AZ	AZ
		A1	A1
		A2	A2
CIE		U	U
		N	R
		P	S
		Q	T

c) Color Bins ($I_F = 65 \text{ mA}$, $T_s = 25 \text{ }^\circ\text{C}$)

CRI (R _a) Min.	Nominal CCT (K)	Product Code	Color Rank	Chromaticity Bins
80 or 90	2700	SPMWH3228MD★WAW0RK	W0 (Whole bin)	W1,W2,W3,W4,W5,W6,W7,W8,W9,WA,WB,WC,WD,WE,WF,WG
		SPMWH3228MD★WAWMRK	WM (Quarter bin)	W6, W7, WA, WB
		SPMWH3228MD★WAWKRK	WK (K Kitting bin)	W1,W2,W3,W4,W5,W6,W7,W8,W9,WA,WB,WC,WD,WE,WF,WG
		SPMWH3228MD★WAWURK	WU (Mac3 Only)	WU
3000	3000	SPMWH3228MD★WAWYRK	WY (Y Kitting bin)	WN, WP, WQ, WR, WS, WT, WU
		SPMWH3228MD★WAV0RK	V0 (Whole bin)	V1, V2, V3, V4, V5, V6, V7, V8,V9, VA, VB, VC, VD, VE, VF, VG
		SPMWH3228MD★WAVMRK	VM (Quarter bin)	V6, V7, VA, VB
		SPMWH3228MD★WAVKRK	VK (K Kitting bin)	V1, V2, V3, V4, V5, V6, V7, V8,V9, VA, VB, VC, VD, VE, VF, VG
3500	3500	SPMWH3228MD★WAVURK	VU (Mac3 Only)	VU
		SPMWH3228MD★WAVYRK	VY (Y Kitting bin)	VN, VP, VQ, VR, VS, VT, VU
		SPMWH3228MD★WAU0RK	U0 (Whole bin)	U1, U2, U3, U4, U5, U6, U7, U8,U9, UA, UB, UC, UD, UE, UF, UG
		SPMWH3228MD★WAUMRK	UM (Quarter bin)	U6, U7, UA, UB
4000	4000	SPMWH3228MD★WAUKRK	UK (K Kitting bin)	U1, U2, U3, U4, U5, U6, U7, U8,U9, UA, UB, UC, UD, UE, UF, UG
		SPMWH3228MD★WAUURK	UU (Mac3 Only)	UU
		SPMWH3228MD★WAUYRK	UY (Y Kitting bin)	UN, UP, UQ, UR, US, UT, UU
		SPMWH3228MD★WAT0RK	T0 (Whole bin)	T1, T2, T3, T4, T5, T6, T7, T8,T9, TA, TB, TC, TD, TE, TF, TG
5000	5000	SPMWH3228MD★WATMRK	TM (Quarter bin)	T6, T7, TA, TB
		SPMWH3228MD★WATKRK	TK (K Kitting bin)	T1, T2, T3, T4, T5, T6, T7, T8,T9, TA, TB, TC, TD, TE, TF, TG
		SPMWH3228MD★WATURK	TU (Mac3 Only)	TU
		SPMWH3228MD★WATYRK	TY (Y Kitting bin)	TN, TP, TQ, TR, TS, TT, TU
5700	5700	SPMWH3228MD★WAR0RK	R0 (Whole bin)	R1, R2, R3, R4, R5, R6, R7, R8, R9RA, RB, RC, RD, RE, RF, RG
		SPMWH3228MD★WARMRK	RM (Quarter bin)	R6, R7, RA, RB
		SPMWH3228MD★WARKRK	RK (K Kitting bin)	R1, R2, R3, R4, R5, R6, R7, R8, R9RA, RB, RC, RD, RE, RF, RG
		SPMWH3228MD★WARURK	RU (Mac3 Only)	RU
6500	6500	SPMWH3228MD★WARYRK	RY (Y Kitting bin)	RN, RP, RQ, RR, RS, RT, RU
		SPMWH3228MD★WAQ0RK	Q0 (Whole bin)	Q1, Q2, Q3, Q4, Q5, Q6, Q7, Q8, Q9QA, QB, QC, QD, QE, QF, QG
		SPMWH3228MD★WAQMRK	QM (Quarter bin)	Q6, Q7, QA, QB
		SPMWH3228MD★WAQKRK	QK (K Kitting bin)	Q1, Q2, Q3, Q4, Q5, Q6, Q7, Q8, Q9QA, QB, QC, QD, QE, QF, QG
6500	6500	SPMWH3228MD★WAQURK	QU (Mac3 Only)	QU
		SPMWH3228MD★WAQYRK	QY (Y Kitting bin)	QN, QP, QQ, QR, QS, QT, QU
		SPMWH3228MD★WAP0RK	P0 (Whole bin)	P1, P2, P3, P4, P5, P6, P7, P8, P9PA, PB, PC, PD, PE, PF, PG
		SPMWH3228MD★WAPMRK	PM (Quarter bin)	P6, P7, PA, PB
6500	6500	SPMWH3228MD★WAPKRK	PK (K Kitting bin)	P1, P2, P3, P4, P5, P6, P7, P8, P9PA, PB, PC, PD, PE, PF, PG
		SPMWH3228MD★WAPURK	PU (Mac3 Only)	PU
		SPMWH3228MD★WAPYRK	PY (Y Kitting bin)	PN, PP, PQ, PR, PS, PT, PU

Note: "★" can be "5" (Ra80) or "7" (Ra90)

d) Voltage Bins ($I_f = 65 \text{ mA}$, $T_s = 25 \text{ °C}$)

CRI (R_a) Min.	Nominal CCT (K)	Product Code	Voltage Rank	Voltage Bin	Voltage Range (V)
-	-	-	WA or WK	AY	2.6 ~ 2.7
-	-	-		AZ	2.7 ~ 2.8
-	-	-		A1	2.8 ~ 2.9
-	-	-		A2	2.9 ~ 3.0
-	-	-	WN or WM	AY	2.6 ~ 2.7
-	-	-		AZ	2.7 ~ 2.8

e) Chromaticity Region & Coordinates for whole bin or quarter bin or K kitting bin ($I_F = 65 \text{ mA}$, $T_s = 25 \text{ }^\circ\text{C}$)



e) Chromaticity Region & Coordinates

Region	CIE x	CIE y	Region	CIE x	CIE y
W rank (2700 K)					
W1	0.4373	0.3893	W9	0.4465	0.4071
	0.4418	0.3981		0.4513	0.4164
	0.4475	0.3994		0.4573	0.4178
	0.4428	0.3906		0.4523	0.4085
W2	0.4428	0.3906	WA	0.4523	0.4085
	0.4475	0.3994		0.4573	0.4178
	0.4532	0.4008		0.4634	0.4193
	0.4483	0.3919		0.4582	0.4099
W3	0.4483	0.3919	WB	0.4582	0.4099
	0.4532	0.4008		0.4634	0.4193
	0.4589	0.4021		0.4695	0.4207
	0.4538	0.3931		0.4641	0.4112
W4	0.4538	0.3931	WC	0.4641	0.4112
	0.4589	0.4021		0.4695	0.4207
	0.4646	0.4034		0.4756	0.4221
	0.4593	0.3944		0.4700	0.4126
W5	0.4418	0.3981	WD	0.4513	0.4164
	0.4465	0.4071		0.4562	0.4260
	0.4523	0.4085		0.4624	0.4274
	0.4475	0.3994		0.4573	0.4178
W6	0.4475	0.3994	WE	0.4573	0.4178
	0.4523	0.4085		0.4624	0.4274
	0.4582	0.4099		0.4687	0.4289
	0.4532	0.4008		0.4634	0.4193
W7	0.4532	0.4008	WF	0.4634	0.4193
	0.4582	0.4099		0.4687	0.4289
	0.4641	0.4112		0.4750	0.4304
	0.4589	0.4021		0.4695	0.4207
W8	0.4589	0.4021	WG	0.4695	0.4207
	0.4641	0.4112		0.4750	0.4304
	0.4700	0.4126		0.4813	0.4319
	0.4646	0.4034		0.4756	0.4221

Region	CIE x	CIE y	Region	CIE x	CIE y
V rank (3000 K)					
V1	0.4147	0.3814	V9	0.4221	0.3984
	0.4183	0.3898		0.4259	0.4073
	0.4242	0.3919		0.4322	0.4096
	0.4203	0.3833		0.4281	0.4006
V2	0.4203	0.3833	VA	0.4281	0.4006
	0.4242	0.3919		0.4322	0.4096
	0.4300	0.3939		0.4385	0.4119
	0.4259	0.3853		0.4342	0.4028
V3	0.4259	0.3853	VB	0.4342	0.4028
	0.4300	0.3939		0.4385	0.4119
	0.4359	0.3960		0.4449	0.4141
	0.4316	0.3873		0.4403	0.4049
V4	0.4316	0.3873	VC	0.4403	0.4049
	0.4359	0.3960		0.4449	0.4141
	0.4418	0.3981		0.4513	0.4164
	0.4373	0.3893		0.4465	0.4071
V5	0.4183	0.3898	VD	0.4259	0.4073
	0.4221	0.3984		0.4299	0.4165
	0.4281	0.4006		0.4364	0.4188
	0.4242	0.3919		0.4322	0.4096
V6	0.4242	0.3919	VE	0.4322	0.4096
	0.4281	0.4006		0.4364	0.4188
	0.4342	0.4028		0.4430	0.4212
	0.4300	0.3939		0.4385	0.4119
V7	0.4300	0.3939	VF	0.4385	0.4119
	0.4342	0.4028		0.4430	0.4212
	0.4403	0.4049		0.4496	0.4236
	0.4359	0.3960		0.4449	0.4141
V8	0.4359	0.3960	VG	0.4449	0.4141
	0.4403	0.4049		0.4496	0.4236
	0.4465	0.4071		0.4562	0.4260
	0.4418	0.3981		0.4513	0.4164

e) Chromaticity Region & Coordinates

Region	CIE x	CIE y	Region	CIE x	CIE y
U rank (3500 K)					
U1	0.3889	0.3690	U9	0.3941	0.3848
	0.3915	0.3768		0.3968	0.3930
	0.3981	0.3800		0.4040	0.3966
	0.3953	0.3720		0.4010	0.3882
U2	0.3953	0.3720	UA	0.4010	0.3882
	0.3981	0.3800		0.4040	0.3966
	0.4048	0.3832		0.4113	0.4001
	0.4017	0.3751		0.4080	0.3916
U3	0.4017	0.3751	UB	0.4080	0.3916
	0.4048	0.3832		0.4113	0.4001
	0.4116	0.3865		0.4186	0.4037
	0.4082	0.3782		0.4150	0.3950
U4	0.4082	0.3782	UC	0.4150	0.3950
	0.4116	0.3865		0.4186	0.4037
	0.4183	0.3898		0.4259	0.4073
	0.4147	0.3814		0.4221	0.3984
U5	0.3915	0.3768	UD	0.3968	0.3930
	0.3941	0.3848		0.3996	0.4015
	0.4010	0.3882		0.4071	0.4052
	0.3981	0.3800		0.4040	0.3966
U6	0.3981	0.3800	UE	0.4040	0.3966
	0.4010	0.3882		0.4071	0.4052
	0.4080	0.3916		0.4146	0.4089
	0.4048	0.3832		0.4113	0.4001
U7	0.4048	0.3832	UF	0.4113	0.4001
	0.4080	0.3916		0.4146	0.4089
	0.4150	0.3950		0.4222	0.4127
	0.4116	0.3865		0.4186	0.4037
U8	0.4116	0.3865	UG	0.4186	0.4037
	0.4150	0.3950		0.4222	0.4127
	0.4221	0.3984		0.4299	0.4165
	0.4183	0.3898		0.4259	0.4073

Region	CIE x	CIE y	Region	CIE x	CIE y
T rank (4000 K)					
T1	0.3670	0.3578	T9	0.3702	0.3722
	0.3726	0.3612		0.3763	0.3760
	0.3744	0.3685		0.3782	0.3837
	0.3686	0.3649		0.3719	0.3797
T2	0.3726	0.3612	TA	0.3763	0.3760
	0.3783	0.3646		0.3825	0.3798
	0.3804	0.3721		0.3847	0.3877
	0.3744	0.3685		0.3782	0.3837
T3	0.3783	0.3646	TB	0.3825	0.3798
	0.3840	0.3681		0.3887	0.3836
	0.3863	0.3758		0.3912	0.3917
	0.3804	0.3721		0.3847	0.3877
T4	0.3840	0.3681	TC	0.3887	0.3837
	0.3898	0.3716		0.3950	0.3875
	0.3924	0.3794		0.3978	0.3958
	0.3863	0.3758		0.3912	0.3917
T5	0.3686	0.3649	TD	0.3719	0.3797
	0.3744	0.3685		0.3782	0.3837
	0.3763	0.3760		0.3802	0.3916
	0.3702	0.3722		0.3736	0.3874
T6	0.3744	0.3685	TE	0.3782	0.3837
	0.3804	0.3721		0.3847	0.3877
	0.3825	0.3798		0.3869	0.3958
	0.3763	0.3760		0.3802	0.3916
T7	0.3804	0.3721	TF	0.3847	0.3877
	0.3863	0.3758		0.3912	0.3917
	0.3887	0.3836		0.3937	0.4001
	0.3825	0.3798		0.3869	0.3958
T8	0.3863	0.3758	TG	0.3912	0.3917
	0.3924	0.3794		0.3978	0.3958
	0.3950	0.3875		0.4006	0.4044
	0.3887	0.3836		0.3937	0.4001

e) Chromaticity Region & Coordinates

Region	CIE x	CIE y	Region	CIE x	CIE y
R rank (5000 K)					
R1	0.3366	0.3369	R9	0.3374	0.3554
	0.3369	0.3431		0.3371	0.3493
	0.3407	0.3460		0.3411	0.3522
	0.3403	0.3398		0.3415	0.3587
R2	0.3403	0.3398	RA	0.3415	0.3587
	0.3407	0.3460		0.3411	0.3522
	0.3446	0.3491		0.3451	0.3554
	0.3440	0.3427		0.3457	0.3621
R3	0.3446	0.3491	RB	0.3451	0.3554
	0.3440	0.3427		0.3457	0.3621
	0.3477	0.3458		0.3500	0.3655
	0.3485	0.3522		0.3492	0.3587
R4	0.3485	0.3522	RC	0.3492	0.3587
	0.3477	0.3458		0.3500	0.3655
	0.3514	0.3487		0.3542	0.3690
	0.3524	0.3554		0.3533	0.3620
R5	0.3371	0.3493	RD	0.3376	0.3616
	0.3369	0.3431		0.3374	0.3554
	0.3407	0.3460		0.3415	0.3587
	0.3411	0.3522		0.3420	0.3652
R6	0.3407	0.3460	RE	0.3415	0.3587
	0.3411	0.3522		0.3420	0.3652
	0.3451	0.3554		0.3463	0.3687
	0.3446	0.3491		0.3457	0.3621
R7	0.3446	0.3491	RF	0.3457	0.3621
	0.3451	0.3554		0.3463	0.3687
	0.3492	0.3587		0.3507	0.3724
	0.3485	0.3522		0.3500	0.3655
R8	0.3485	0.3522	RG	0.3500	0.3655
	0.3492	0.3587		0.3507	0.3724
	0.3533	0.3620		0.3551	0.3760
	0.3524	0.3554		0.3542	0.3690

Region	CIE x	CIE y	Region	CIE x	CIE y
Q rank (5700 K)					
Q1	0.3218	0.3298	Q9	0.3211	0.3407
	0.3222	0.3243		0.3215	0.3353
	0.3258	0.3275		0.3254	0.3388
	0.3256	0.3331		0.3252	0.3444
Q2	0.3256	0.3331	QA	0.3252	0.3444
	0.3258	0.3275		0.3254	0.3388
	0.3294	0.3306		0.3293	0.3423
	0.3294	0.3364		0.3293	0.3481
Q3	0.3294	0.3364	QB	0.3293	0.3481
	0.3294	0.3306		0.3293	0.3423
	0.3330	0.3338		0.3332	0.3458
	0.3331	0.3398		0.3333	0.3518
Q4	0.3331	0.3398	QC	0.3333	0.3518
	0.3330	0.3338		0.3332	0.3458
	0.3366	0.3369		0.3371	0.3493
	0.3369	0.3431		0.3374	0.3554
Q5	0.3215	0.3353	QD	0.3207	0.3462
	0.3218	0.3298		0.3211	0.3407
	0.3256	0.3331		0.3252	0.3444
	0.3254	0.3388		0.3250	0.3501
Q6	0.3254	0.3388	QE	0.3250	0.3501
	0.3256	0.3331		0.3252	0.3444
	0.3294	0.3364		0.3293	0.3481
	0.3293	0.3423		0.3292	0.3539
Q7	0.3293	0.3423	QF	0.3292	0.3539
	0.3294	0.3364		0.3293	0.3481
	0.3331	0.3398		0.3333	0.3518
	0.3332	0.3458		0.3334	0.3578
Q8	0.3332	0.3458	QG	0.3334	0.3578
	0.3331	0.3398		0.3333	0.3518
	0.3369	0.3431		0.3374	0.3554
	0.3371	0.3493		0.3376	0.3616

e) Chromaticity Region & Coordinates

Region	CIE x	CIE y	Region	CIE x	CIE y
P rank (6500 K)					
P1	0.3068	0.3113	P9	0.3048	0.3207
	0.3106	0.3150		0.3089	0.3249
	0.3098	0.3199		0.3080	0.3298
	0.3058	0.3160		0.3038	0.3256
P2	0.3106	0.3150	PA	0.3089	0.3249
	0.3144	0.3186		0.313	0.3290
	0.3137	0.3238		0.3123	0.3341
	0.3098	0.3199		0.3080	0.3298
P3	0.3144	0.3186	PB	0.3130	0.3290
	0.3183	0.3224		0.3172	0.3332
	0.3177	0.3278		0.3166	0.3384
	0.3137	0.3238		0.3123	0.3341
P4	0.3183	0.3224	PC	0.3172	0.3332
	0.3221	0.3261		0.3214	0.3373
	0.3218	0.3317		0.3210	0.3427
	0.3177	0.3278		0.3166	0.3384
P5	0.3058	0.3160	PD	0.3038	0.3256
	0.3098	0.3199		0.3080	0.3298
	0.3089	0.3249		0.3072	0.3348
	0.3048	0.3207		0.3028	0.3304
P6	0.3098	0.3199	PE	0.3080	0.3298
	0.3137	0.3238		0.3123	0.3341
	0.3130	0.3290		0.3115	0.3391
	0.3089	0.3249		0.3072	0.3348
P7	0.3137	0.3238	PF	0.3123	0.3341
	0.3177	0.3278		0.3166	0.3384
	0.3172	0.3332		0.3160	0.3436
	0.313	0.3290		0.3115	0.3391
P8	0.3177	0.3278	PG	0.3166	0.3384
	0.3218	0.3317		0.3210	0.3427
	0.3214	0.3373		0.3206	0.3481
	0.3172	0.3332		0.3160	0.3436

Note: Samsung maintains measurement tolerance of: $C_x, C_y = \pm 0.005$

f) Chromaticity Region & Coordinates for Y kitting bin or mac3 only bin ($I_f = 65 \text{ mA}$, $T_s = 25 \text{ }^\circ\text{C}$)



f) Chromaticity Region & Coordinates



MacAdam	CCT (K)	Center point		Major-axis	Minor-axis	Rotation
		CIE x	CIE y	a	b	Φ
3 step	2700	0.4578	0.4101	0.0081	0.0042	53.70
	3000	0.4338	0.4030	0.0083	0.0041	53.22
	3500	0.4073	0.3917	0.0093	0.0041	54.00
	4000	0.3818	0.3797	0.0094	0.0040	53.72
	5000	0.3447	0.3553	0.0082	0.0035	59.62
	5700	0.3287	0.3417	0.0075	0.0032	59.10
	6500	0.3123	0.3282	0.0067	0.0029	58.57
5 step	2700	0.4578	0.4101	0.0135	0.0070	53.70
	3000	0.4338	0.4030	0.0138	0.0068	53.22
	3500	0.4073	0.3917	0.0155	0.0068	54.00
	4000	0.3818	0.3797	0.0157	0.0067	53.72
	5000	0.3447	0.3553	0.0137	0.0058	59.62
	5700	0.3287	0.3417	0.0125	0.0053	59.10
	6500	0.3123	0.3282	0.0112	0.0048	58.57

Note: Samsung maintains measurement tolerance of: $C_x, C_y = \pm 0.005$

f) Chromaticity Region & Coordinates



CCT	Region	CIE x	CIE y	CCT	Region	CIE x	CIE y	CCT	Region	CIE x	CIE y
2700K	1	0.4521	0.4142	3000K	1	0.4283	0.4071	3500K	1	0.4018	0.3957
	2	0.4619	0.4216		2	0.4382	0.4146		2	0.4125	0.4046
	3	0.4675	0.4175		3	0.4437	0.4105		3	0.418	0.4005
	4	0.4634	0.4059		4	0.4393	0.3989		4	0.4128	0.3877
	5	0.4537	0.3986		5	0.4293	0.3913		5	0.4022	0.3788
	6	0.4481	0.4028		6	0.4239	0.3954		6	0.3966	0.3828
	7	0.4544	0.4126		7	0.4305	0.4054		7	0.404	0.3941
	8	0.4603	0.417		8	0.4364	0.41		8	0.4104	0.3994
	9	0.4636	0.4145		9	0.4397	0.4075		9	0.4137	0.397
	10	0.4612	0.4076		10	0.4371	0.4005		10	0.4106	0.3893
	11	0.4553	0.4032		11	0.4311	0.396		11	0.4042	0.384
	12	0.452	0.4057		12	0.4279	0.3984		12	0.4009	0.3864
4000K	1	0.3764	0.3837	5000K	1	0.3397	0.3583	5700K	1	0.3242	0.3445
	2	0.3871	0.3926		2	0.3482	0.367		2	0.332	0.3524
	3	0.3925	0.3887		3	0.3532	0.364		3	0.3365	0.3496
	4	0.3872	0.3758		4	0.3497	0.3524		4	0.3333	0.339
	5	0.3765	0.3668		5	0.3412	0.3436		5	0.3254	0.331
	6	0.3711	0.3707		6	0.3362	0.3465		6	0.3209	0.3338
	7	0.3786	0.3821		7	0.3417	0.3571		7	0.326	0.3434
	8	0.385	0.3874		8	0.3468	0.3623		8	0.3307	0.3481
	9	0.3882	0.3851		9	0.3498	0.3605		9	0.3334	0.3464
	10	0.385	0.3773		10	0.3477	0.3535		10	0.3314	0.3401
	11	0.3786	0.372		11	0.3426	0.3483		11	0.3267	0.3353
	12	0.3754	0.3743		12	0.3396	0.35		12	0.324	0.3369

f) Chromaticity Region & Coordinates

CCT	Region	CIE x	CIE y
6500K	1	0.3082	0.3307
	2	0.3153	0.3377
	3	0.3194	0.3352
	4	0.3164	0.3257
	5	0.3093	0.3187
	6	0.3052	0.3212
	7	0.3098	0.3297
	8	0.3141	0.3339
	9	0.3166	0.3324
	10	0.3148	0.3267
	11	0.3105	0.3225
	12	0.308	0.324

Note: Samsung maintains measurement tolerance of: $C_x, C_y = \pm 0.005$

3. Typical Characteristics Graphs

a) Spectrum Distribution ($I_f = 65 \text{ mA}$, $T_s = 25 \text{ }^\circ\text{C}$)

CCT: 2700 K (80 CRI)



CCT: 3000 K (80 CRI)



CCT: 3500 K (80 CRI)



CCT: 4000 K (80 CRI)



CCT: 5000 K (80 CRI)



CCT: 5700 K (80 CRI)



CCT: 6500 K (80 CRI)

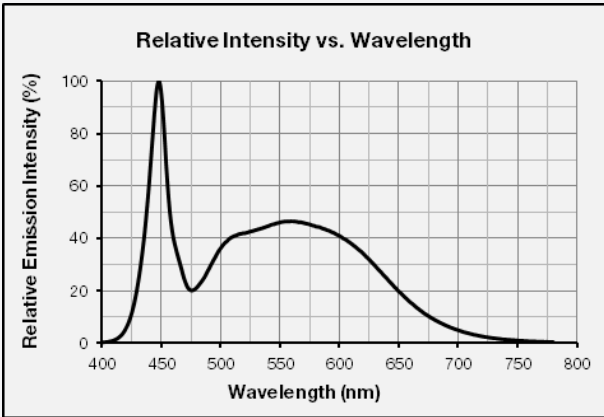

CCT: 2700 K (90 CRI)

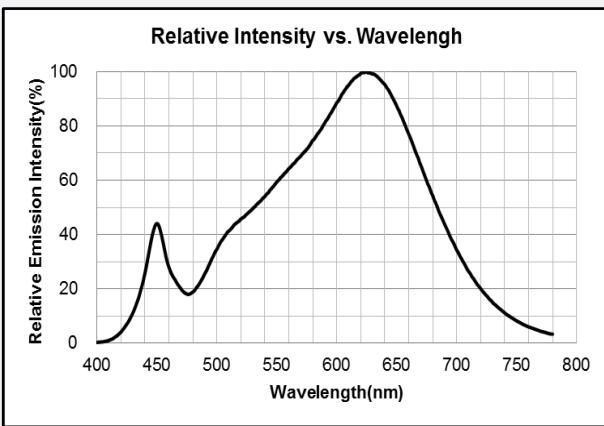

CCT: 3000 K (90 CRI)



CCT: 3500 K (90 CRI)

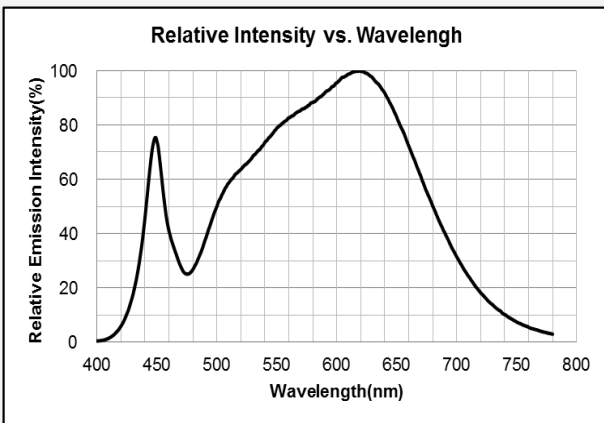

CCT: 4000 K (90 CRI)



CCT: 5000 K (90 CRI)



CCT: 5700 K (90 CRI)



CCT: 6500 K (90 CRI)

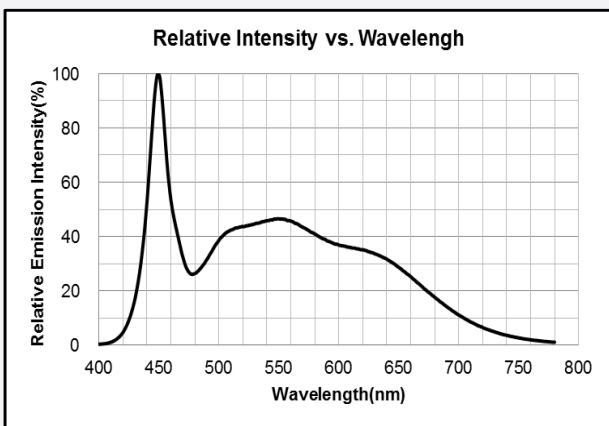

b) Forward Current Characteristics ($T_s = 25^\circ\text{C}$)



c) Temperature Characteristics ($I_F = 65 \text{ mA}$)



d) Color Shift Characteristics ($I_F = 65 \text{ mA}$, $T_s = 25 \text{ °C}$)



e) Derating Curve



f) Beam Angle Characteristics ($I_f = 65 \text{ mA}$, $T_s = 25 \text{ }^\circ\text{C}$)

4. Outline Drawing & Dimension



Notes:

- 1) T_s point and measurement method:
 - ① Measure one point at the cathode pad, if necessary remove PSR of PCB to reach T_s point.
 - ② All pads must be soldered to the PCB to dissipate heat properly, otherwise the LED can be damaged.

Precautions:

- 1) Pressure on the LEDs will influence to the reliability of the LEDs. Precautions should be taken to avoid strong pressure on the LEDs. Do not put stress on the LEDs during heating.
- 2) Re-soldering should not be done after the LEDs have been soldered. If re-soldering is unavoidable, LED's characteristics should be carefully checked before and after such repair.
- 3) Do not stack assembled PCBs together. Since materials of LEDs is soft, abrasion between two PCB assembled with LED might cause catastrophic failure of the LEDs.

5. Reliability Test Items & Conditions

a) Test Items

Test Item	Test Condition	Test Hour / Cycle	Sample No.
Room Temperature Life Test	25 °C, DC Max Current	1000 h	22
High Temperature Life Test	85 °C, DC Max Current	1000 h	22
High Temperature Humidity Life Test	60 °C, 90 % RH, DC 65mA	1000 h	22
Low Temperature Life Test	-40 °C, DC Max Current	1000 h	22
Powered Temperature Cycle Test	-45 °C ~ 85 °C, each 20 min, on/off 5 min Temp. Change time 100min, DC Max Current	100 cycles	22
Temperature Cycle	-45°C / 15 min ↔ 125 °C / 15 min	200 cycles	100
High Temperature Storage	85 °C	1000 h	11
Low Temperature Storage	-40 °C	1000 h	11
ESD (HBM)	 <p> R_1: 10 MΩ R_2: 1.5 kΩ C: 100 pF V: ± 5 kV </p>	5 times	30

b) Criteria for Judging the Damage

Item	Symbol	Test Condition ($T_s = 25$ °C)	Limit	
			Min	Max
Forward Voltage	V_F	$I_F = 65$ mA	Init. Value * 0.9	Init. Value * 1.1
Luminous Flux	Φ_v	$I_F = 65$ mA	Init. Value * 0.7	Init. Value * 1.1

6. Soldering Conditions

a) Reflow Conditions (Pb free)

Reflow frequency: 2 times max.



b) Manual Soldering Conditions

Not more than 5 seconds @ max. 300 °C, under soldering iron.

7. Tape & Reel

a) Taping Dimension

(unit: mm)



A0	3.10±0.1	P0	4.00±0.1	T	0.20±0.05	D0	1.60(MAX)
B0	3.70±0.1	P1	4.00±0.1	E	1.75±0.1	D1	1.05(MIN)
K0	1.00±0.1	P2	2.00±0.1	F	3.50±0.05	V	8.00±0.1

b) Reel Dimension (max 4,000 pcs)

(unit: mm)

**Notes:**

- 1) Quantity: The quantity/reel is 4,000 pcs
- 2) All dimensions are millimeters (tolerance : ± 0.2 mm)
- 3) Packaging: P/N, Manufacturing data code no. and quantity are indicated on the aluminum packing bag

c) Reel Dimension (max 16,000 pcs)

(unit: mm)



Notes:

- 1) Quantity: The quantity/reel is 16,000 pcs
- 2) All dimensions are millimeters (tolerance : ±0.2mm)
- 3) Packaging: P/N, Manufacturing data code no. and quantity are indicated on the aluminum packing bag

8. Label Structure

a) Label Structure



Note: Denoted bin code and product code above is only an example (see description on page 6)

Bin Code:

- ⒶⒷ: Forward Voltage bin (refer to page 10)
- ⒸⒹ: Chromaticity bin (refer to page 11-18)
- ⒺⒻ: Luminous Flux bin (refer to page 7)

b) Lot Number

The lot number is composed of the following characters:



①②③④⑤⑥⑦⑧⑨ / |ⒶⒷⒸ / 4,000 pcs

- ①② : Production site (G3 or GP : Shenzhen, China)
- ③ : Product state (A: Normal, B: Bulk, C: First Production, R: Reproduction, S: Sample)
- ④ : Year (A: 2016, B: 2017, C: 2018, D: 2019, E: 2020...)
- ⑤ : Month (1~9, A, B, C)
- ⑥ : Day (1~9, A, B~V)
- ⑦⑧⑨ ⒶⒷⒸ : Product serial number

9. Packing Structure

a) Packing Process (The quantity of PKG on the Reel to be Max 4,000 pcs)

Reel



Aluminum Vinyl Packing Bag



Outer Box

Material: Paper (SW3B(B))

Type	Size (mm)			Note
	L	W	H	
7 inch L	245 ± 5	220 ± 5	182 ± 5	Up to 10 reels
7 inch S	245 ± 5	220 ± 5	86 ± 5	Up to 5 reels

① Side Label



b) Packing Process (The quantity of PKG on the Reel to be Max 16,000 pcs)

Reel

LM281BZ+ RA80 5000K
ERC A1R1RK
 SPMWH3228MD5WKR0RK A1R1RK
 G3ACA4001 / IOAA / 16000 pcs
SAMSUNG



Aluminum Vinyl Packing Bag

LM281BZ+ RA80 5000K
ERC A1R1RK
 SPMWH3228MD5WKR0RK A1R1RK
 G3ACA4001 / IOAA / 16000 pcs
SAMSUNG



Outer Box

LM281BZ+ RA80 5000K
ERC A1R1RK
 SPMWH3228MD5WAR0RK A1R1RK
 G3ACA4001 / IOAA / 480000 pcs
SAMSUNG

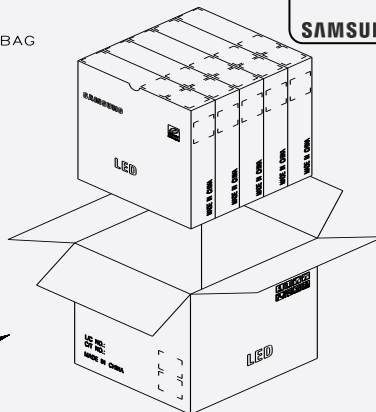
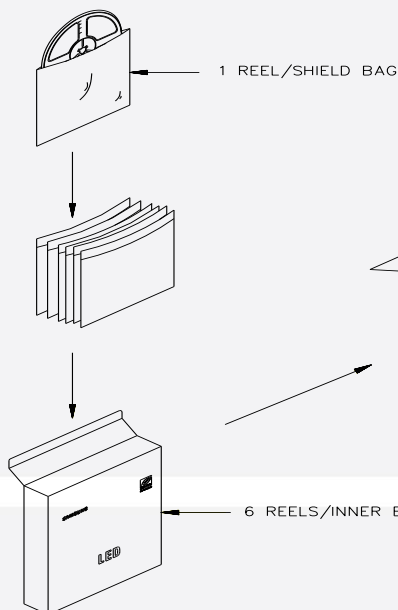

c) Packing Process for kitting (The quantity of PKG on the Reel to be Max 4,000 pcs)

Reel

Kitting 'A'

LM281BZ+ RA80 ★K
 **A1★1RK**
 SPMWH3228MD5WA★KRK A1★1RK
 G3ACA4001 / IOAA / 4000 pcs
SAMSUNG

Kitting 'B'

LM281BZ+ RA80 ★K
 **A1★CRK**
 SPMWH3228MD5WA★KRK A3★CRK
 G3ACA4001 / IOAA / 4000 pcs
SAMSUNG



Aluminum Vinyl Packing Bag

Kitting 'A'

LM281BZ+ RA80 ★K
 **A1★1RK**
 SPMWH3228MD5WA★KRK A1★1RK
 G3ACA4001 / IOAA / 4000 pcs
SAMSUNG

Kitting 'B'

LM281BZ+ RA80 ★K
 **A1★CRK**
 SPMWH3228MD5WA★KRK A3★CRK
 G3ACA4001 / IOAA / 4000 pcs
SAMSUNG



Outer Box

Kitting 'A'

LM281BZ+ RA80 ★K
 **A1★1RK**
 SPMWH3228MD5WA★KRK A1★1RK
 G3ACA4001 / IOAA / 20000 pcs
SAMSUNG [BOX Label]

Kitting 'B'

LM281BZ+ RA80 ★K
 **A1★CRK**
 SPMWH3228MD5WA★KRK A3★CRK
 G3ACA4001 / IOAA / 20000 pcs
SAMSUNG [BOX Label]



Material: Paper (SW3B(B))

Type	Size (mm)			Note
	L	W	H	
7 inch L	245 ± 5	220 ± 5	182 ± 5	Up to 10 reels

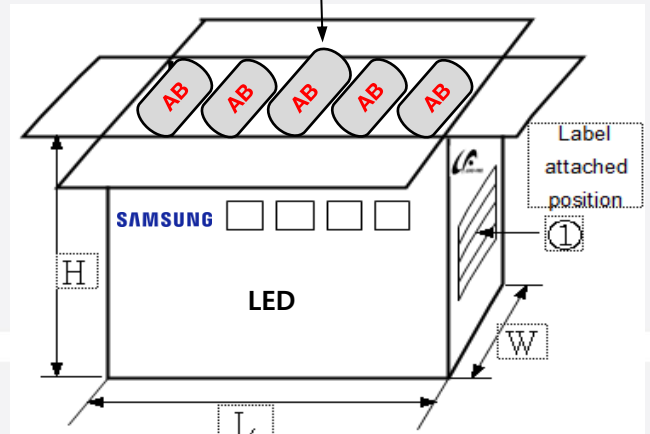

d) Packing Process for kitting (The quantity of PKG on the Reel to be Max 16,000 pcs)

Reel

Kitting 'A'

LM281BZ+ RA80 ★K
 **A1★1RK**
 SPMWH3228MD5WK★KRK A1★1RK
 G3ACA4001 / IOAA / 16000 pcs
SAMSUNG

Kitting 'B'

LM281BZ+ RA80 ★K
 **A1★CRK**
 SPMWH3228MD5WK★KRK A1★CRK
 G3ACA4001 / IOAA / 16000 pcs
SAMSUNG



Aluminum Vinyl Packing Bag

Kitting 'A'

LM281BZ+ RA80 ★K
 **A1★1RK**
 SPMWH3228MD5WK★KRK A1★1RK
 G3ACA4001 / IOAA / 16000 pcs
SAMSUNG

Kitting 'B'

LM281BZ+ RA80 ★K
 **A1★CRK**
 SPMWH3228MD5WK★KRK A1★CRK
 G3ACA4001 / IOAA / 16000 pcs
SAMSUNG



Outer Box

Kitting 'A'

LM281BZ+ RA80 ★K
 **A1★1RK**
 SPMWH3228MD5WK★KRK A1★1RK
 G3ACA4001 / IOAA / 80000 pcs
SAMSUNG [BOX Label]

Kitting 'B'

LM281BZ+ RA80 ★K
 **A1★CRK**
 SPMWH3228MD5WK★KRK A1★CRK
 G3ACA4001 / IOAA / 80000 pcs
SAMSUNG [BOX Label]



Material: Paper (SW3B(B))

Type	Size (mm)			Note
	L	W	H	
13 inch	378 ± 5	345 ± 5	405 ± 5	Up to 10 reels



e) Aluminum Vinyl Packing Bag



CAUTION

This bag contains
MOISTURE SENSITIVE DEVICES

LEVEL
2a

1. Shelf life in sealed bag: 12 months at <math><40^{\circ}\text{C}</math> and <math><90\%</math> relative humidity (RH)
2. Peak package body temperature: 240 °C
3. After this bag is opened, devices that will be subjected to reflow solder or other high temperature processes must be:
 - a. Mounted within 672 hours at factory conditions of equal to or less than 30°C /60% RH, or
 - b. Stored at <math><10\%</math> RH
4. Devices require bake, before mounting, if:
 - a. Humidity Indicator Card is >60% when read at 23±5°C, or
 - b. 2a is not met.
5. If baking is required, devices must be baked for 10 ~ 24 hours at 60±5°C

Note: If device containers cannot be subjected to high temperature or shorter bake times are desired, reference IPC/JEDEC J-STD-033 for bake procedure.

Bag seal due date: _____
(If blank, see code label)

Note: Level and body temperature by IPC/JEDEC J-STD-020



LM281BZ+ RA80 5000K
ERC A1R1RK

SPMWH3228MD5WAR0RK A1R1RK
G3ACA4001 / 10AA / 4000 pcs

SAMSUNG



ATTENTION

OBSEVE PRECAUTIONS
FOR HANDLINE
ELECTROSTATIC
SENSITIVE
DEVICES



■ 주의 사항

이 알루미늄 지퍼 백은 습기 및 정전기로부터 제품을 보호하기 위하여 제작되었습니다. 개봉 후에는 즉시 솔더 작업을 실시하는 것을 권장합니다.

습기 및 정전기로부터 제품을 보호 하기 위해서 개봉 후 사용하지 않는 자재는 본 팩에 넣어 보관 하시기 바랍니다. 사용하지 않는 자재를 본 팩에 넣을 때는 반드시 동봉된 드라이 팩과 함께 넣고 지퍼부분을 완전하게 밀봉하여 주시기 바랍니다.

■ Important

This Al Zipper bag is designed to protect the enclosed products from moisture and ESD. Once opened, the products should be soldered onto the printed circuit board immediately. When not in use, please do not leave the products unprotected by the Al Zipper Bag. To repack unused products., please ensure the zip-lock is completely sealed with the dry pack left inside.

f) Humidity Indicator Card inside Aluminum Vinyl Bag



10. Precautions in Handling & Use

- 1) For over-current protection, users are recommended to apply resistors connected in series with the LEDs to mitigate sudden change of the forward current caused by shift of forward voltage.
- 2) This device should not be used in any type of fluid such as water, oil, organic solvent, etc. When cleaning is required, IPA is recommended as the cleaning agent. Some solvent-based cleaning agent may damage the silicone resins used in the device.
- 3) When the device is in operation, the forward current should be carefully determined considering the maximum ambient temperature and corresponding junction temperature.
- 4) LEDs must be stored in a clean environment.
(Shelf life of sealed bags is 12 months at temperature 0~40 °C, 0~90 % RH).
- 5) After storage bag is opened, device subjected to soldering, solder reflow, or other high temperature processes must be:
 - a. Mounted within 672 hours (28 days) at an assembly line with a condition of no more than 30 °C / 60 % RH^{*Note 1}, or
 - b. Mounted within 24 hours (1 day) at an assembly line with a condition of more than 30 °C / 70 % RH^{*Note 2}, or
 - c. Stored at <10 % RH.

*Note 1, 2: IPC/JEDEC J-STD-033A, Recommended Equivalent Total Floor Life Table

Package Type and Body Thickness	Moisture Sensitivity Level	Maximum Percent Relative Humidity						Temperature
		40%	50%	60%	70%	80%	90%	
Body Thickness <2.1mm	Level 2a	∞	∞	28	1	1	1	30°C
		∞	∞	∞	2	1	1	25°C
		∞	∞	∞	2	2	1	20°C

- 6) Repack unused devices with anti-moisture packing, fold to close any opening and then store in a dry place.
- 7) Devices require baking before mounting, if humidity card reading is >60 % at 23 ± 5 °C.
- 8) Devices must be baked for 10~24 hours at 60 ± 5 °C, if baking is required.
- 9) The LEDs are sensitive to the static electricity and surge current. It is recommended to use a wrist band or anti-electrostatic glove when handling the LEDs. If voltage exceeding the absolute maximum rating is applied to LEDs, it may cause damage or even destruction to LED devices. Damaged LEDs may show some unusual characteristics such as increase in leakage current, lowered turn-on voltage, or abnormal lighting of LEDs at low current.
- 10) VOCs (Volatile Organic Compounds) can be generated from adhesives, flux, hardener or organic additives used in luminaires (fixtures). Transparent LED silicone encapsulant is permeable to those chemicals and they may lead to a discoloration of encapsulant when they exposed to heat or light. This phenomenon can cause a significant loss of light emitted (output) from the luminaires. In order to prevent these problems, we recommend users to know the physical properties of materials used in luminaires and they must be carefully selected.
- 11) Risk of sulfurization (or tarnishing)
The LED from Samsung uses a silver-plated lead frame and its surface color may change to black (or dark colored) when it is exposed to sulfur (S), chlorine (Cl) or other halogen compound. Sulfurization of lead frame may cause intensity degradation, change of chromaticity coordinates and, in extreme cases, open circuit. It requires caution. Due to possible sulfurization of lead frame, LED should not be used and stored together with oxidizing substances made of materials such as rubber, plain paper, lead solder cream, etc.

Legal and additional information.

[About Samsung Electronics Co., Ltd.](#)

Samsung inspires the world and shapes the future with transformative ideas and technologies.

The company is redefining the worlds of TVs, smartphones, wearable devices, tablets, digital appliances, network systems, and memory, system LSI, foundry and LED solutions.

For the latest news, please visit the Samsung Newsroom at news.samsung.com.

Copyright © 2020 Samsung Electronics Co., Ltd. All rights reserved.

Samsung is a registered trademark of Samsung Electronics Co., Ltd.

Specifications and designs are subject to change without notice. Non-metric weights and measurements are approximate. All data were deemed correct at time of creation. Samsung is not liable for errors or omissions. All brand, product, service names and logos are trademarks and/or registered trademarks of their respective owners and are hereby recognized and acknowledged.

Samsung Electronics Co., Ltd.

95, Samsung 2-ro

Giheung-gu

Yongin-si, Gyeonggi-do, 446-711



KOREA

www.samsungled.com

SAMSUNG

Looking for pricing, stock, or lifecycle information?

Click below to explore more details on WIN SOURCE:

-  [View SPMWH3228FD5WAPMSA on WIN SOURCE](#)
-  [Samsung Information](#)

Optimize Your Supply Chain with WIN SOURCE Solutions

-  Global Sourcing Solution
-  Obsolete Management
-  Cost Control Management
-  Shortage Management
-  Alternative Solution
-  Excess Inventory Management