



**THE DATASHEET OF  
SPMWH3326MS5WAT3SD**



Middle Power LED Series  
3030

LM301D  
CRI 80

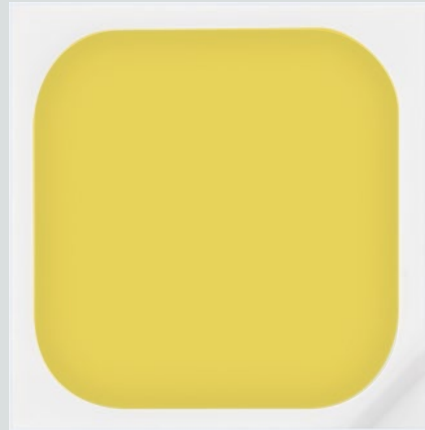

#### Features & Benefits

- 0.3 W class middle power LED
- Mold resin for high reliability
- Standard form factor for design flexibility (3.0 × 3.0 mm)

## Table of Contents

1.	Characteristics	-----	3
2.	Product Code Information	-----	4
3.	Typical Characteristics Graphs	-----	12
4.	Outline Drawing & Dimension	-----	15
5.	Reliability Test Items & Conditions	-----	16
6.	Soldering Conditions	-----	17
7.	Tape & Reel	-----	18
8.	Label Structure	-----	20
9.	Packing Structure	-----	21
10.	Precautions in Handling & Use	-----	24

## 1. Characteristics

### a) Absolute Maximum Rating

Item	Symbol	Rating	Unit	Condition
Ambient / Operating Temperature	$T_a$	-40 ~ +85	°C	-
Storage Temperature	$T_{stg}$	-40 ~ +100	°C	-
LED Junction Temperature	$T_j$	125	°C	-
Forward Current	$I_F$	400	mA	-
Pulse Forward Current	$I_{FP}$	600	mA	Duty 1/10, pulse width 10ms
Assembly Process Temperature	-	260 <10	°C s	-
ESD (HBM)	-	5	kV	-

### b) Electro-optical Characteristics ( $I_F = 65 \text{ mA}$ , $T_s = 25^\circ\text{C}$ )

Item	Unit	Rank	Bin	Min.	Typ.	Max.
Forward Voltage (VF)	V	WA	AY	2.57	-	2.67
			AZ	2.67	-	2.77
			A1	2.77	-	2.87
		WZ	AZ	2.67	-	2.77
Reverse Voltage (@ 5 mA)	V			0.7	-	1.2
Color Rendering Index ( $R_a$ )	-	5		80	-	-
Thermal Resistance (junction to solder point)	°C/W			-	12	-
Beam Angle	°			-	120	-

**Note:**

Samsung maintains measurement tolerance of: forward voltage =  $\pm 0.1 \text{ V}$ , luminous flux =  $\pm 5 \%$ , CRI =  $\pm 3$

## 2. Product Code Information

1	2	3	4	5	6	7	8	9	10	11	12	13	14	15	16	17	18
S	P	M	W	H	3	3	2	6	M	S	5	W	A	V	0	S	D

Digit	PKG Information	Code	Specification
1 2 3	Samsung Package Middle Power	SPM	Middle power
4 5	Color	WH	White
6	Product Version	3	Zener-in
7 8 9	Form Factor	326	3.0 x 3.0 x 0.65 mm; 2 pads
10	Sorting Current	M	65 mA
11	Chromaticity Coordinates	S	MacAdam
12	CRI	5	Min. 80
13 14	Forward Voltage (V)	WA	2.57~2.87
		WZ	2.67~2.77
		W☆	2700
		V☆	3000
		U☆	3500
		T☆	4000
		R☆	5000
		Q☆	5700
		P☆	6500
15 16	CCT (K)		
			AY 2.57~2.67
			AZ 2.67~2.77
			A1 2.77~2.87
			AZ 2.67~2.77
			WN, WP, WQ, WR, WS, WT, WU
			VN, VP, VQ, VR, VS, VT, VU
			UN, UP, UQ, UR, US, UT, UU
			TN, TP, TQ, TR, TS, TT, TU
			RN, RP, RQ, RR, RS, RT, RU
			QN, QP, QQ, QR, QS, QT, QU
			PN, PP, PQ, PR, PS, PT, PU
			☆ : "0" (Whole Bin) or "Y"(Y Kitting) or "3"(MacAdam 3 step)
17 18	Luminous Flux (lm)	SD	SD

a) Luminous Flux Bins( $I_F = 65 \text{ mA}$ ,  $T_s = 25^\circ\text{C}$ )

Nominal CCT (K)	CRI Min.	Product Code	Flux Bin	Flux Range ( $\Phi_v$ , lm)
2700	80	SPMWH3326MS5W★W☆SD	SD	31.5 ~ 34.5
3000	80	SPMWH3326MS5W★V☆SD	SD	32.5 ~ 35.5
3500	80	SPMWH3326MS5W★U☆SD	SD	33.5 ~ 36.5
4000	80	SPMWH3326MS5W★T☆SD	SD	34.5 ~ 37.5
5000	80	SPMWH3326MS5W★R☆SD	SD	35.0 ~ 38.0
5700	80	SPMWH3326MS5W★Q☆SD	SD	34.5 ~ 37.5
6500	80	SPMWH3326MS5W★P☆SD	SD	34.5 ~ 37.5

**Note:** “★” can be “A”(Whole bin), “Z”(AZ Single bin), “☆” can be “0” (Whole bin), “3” (MacAdam 3-step), “Y” (Kitting).

## b) Kitting Rule

### 1) Y Kitting Bin Concept

1. Under agreement between customer and SAMSUNG ELECTRONICS, SAMSUNG can supply kitting bin ( Color).
2. A Chromaticity Coordinates of kitting bin is mixed by kitting procedure.(below kitting simulation)

[Kitting example]

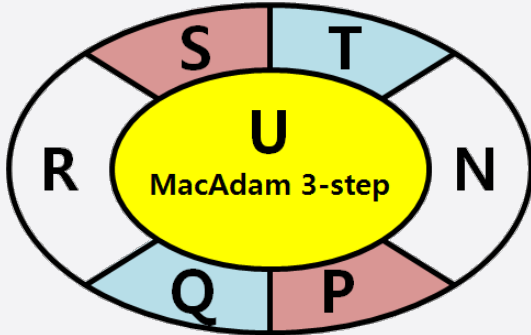

[Binning Information]

Item	Bin #1	Bin #2
VF	AY	AY
	AZ	AZ
	A1	A1
CIE	U	U
	N	R
	P	S
	Q	T
IV	SD	SD

c) Color Bins ( $I_f = 65 \text{ mA}$ ,  $T_s = 25^\circ\text{C}$ )

min. CRI (Ra)	Nominal CCT (K)	Product Code	Color Rank	Chromaticity Bins	
80	2700	SPMWH3326MS5W★W0SD	W0	Whole bin	WN, WP, WQ, WR, WS, WT, WU
		SPMWH3326MS5W★W3SD	W3	MacAdam 3-step ellipse bin	WU
		SPMWH3326MS5W★WYSD	WY	Y Kitting	WN, WP, WQ, WR, WS, WT, WU
	3000	SPMWH3326MS5W★V0SD	V0	Whole bin	VN, VP, VQ, VR, VS, VT, VU
		SPMWH3326MS5W★V3SD	V3	MacAdam 3-step ellipse bin	VU
		SPMWH3326MS5W★VYSD	VY	Y Kitting	VN, VP, VQ, VR, VS, VT, VU
	3500	SPMWH3326MS5W★U0SD	U0	Whole bin	UN, UP, UQ, UR, US, UT, UU
		SPMWH3326MS5W★U3SD	U3	MacAdam 3-step ellipse bin	UU
		SPMWH3326MS5W★UYSD	UY	Y Kitting	UN, UP, UQ, UR, US, UT, UU
	4000	SPMWH3326MS5W★T0SD	T0	Whole bin	TN, TP, TQ, TR, TS, TT, TU
		SPMWH3326MS5W★T3SD	T3	MacAdam 3-step ellipse bin	TU
		SPMWH3326MS5W★TYSD	TY	Y Kitting	TN, TP, TQ, TR, TS, TT, TU
	5000	SPMWH3326MS5W★R0SD	R0	Whole bin	RN, RP, RQ, RR, RS, RT, RU
		SPMWH3326MS5W★R3SD	R3	MacAdam 3-step ellipse bin	RU
		SPMWH3326MS5W★RYSD	RY	Y Kitting	RN, RP, RQ, RR, RS, RT, RU
	5700	SPMWH3326MS5W★Q0SD	Q0	Whole bin	QN, QP, QQ, QR, QS, QT, QU
		SPMWH3326MS5W★Q3SD	Q3	MacAdam 3-step ellipse bin	QU
		SPMWH3326MS5W★QYSD	QY	Y Kitting	QN, QP, QQ, QR, QS, QT, QU
	6500	SPMWH3326MS5W★P0SD	P0	Whole bin	PN, PP, PQ, PR, PS, PT, PU
		SPMWH3326MS5W★P3SD	P3	MacAdam 3-step ellipse bin	PU
		SPMWH3326MS5W★PYSD	PY	Y Kitting	PN, PP, PQ, PR, PS, PT, PU

**Note:** “★” can be “A”(Whole bin), “Z”(AZ Single bin),

d) Voltage Bins ( $I_f = 65 \text{ mA}$ ,  $T_s = 25^\circ\text{C}$ )

CRI (Ra) Min.	Nominal CCT (K)	Product Code	Voltage Rank	Voltage Bin	Voltage Range (V)
-	-	-	-	AY	2.57 ~ 2.67
-	-	-	WA	AZ	2.67 ~ 2.77
-	-	-	-	A1	2.77 ~ 2.87
-	-	-	WZ	AZ	2.67 ~ 2.77

e) Chromaticity Region & Coordinates ( $I_f = 65 \text{ mA}$ ,  $T_s = 25^\circ\text{C}$ )

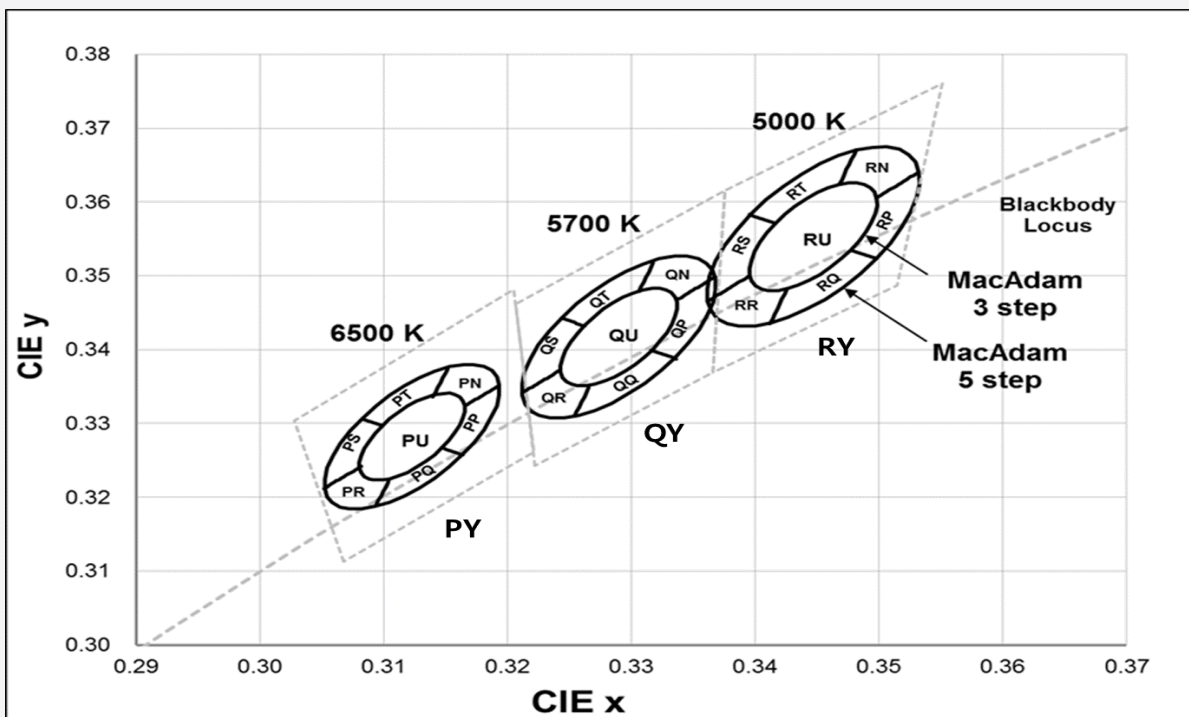
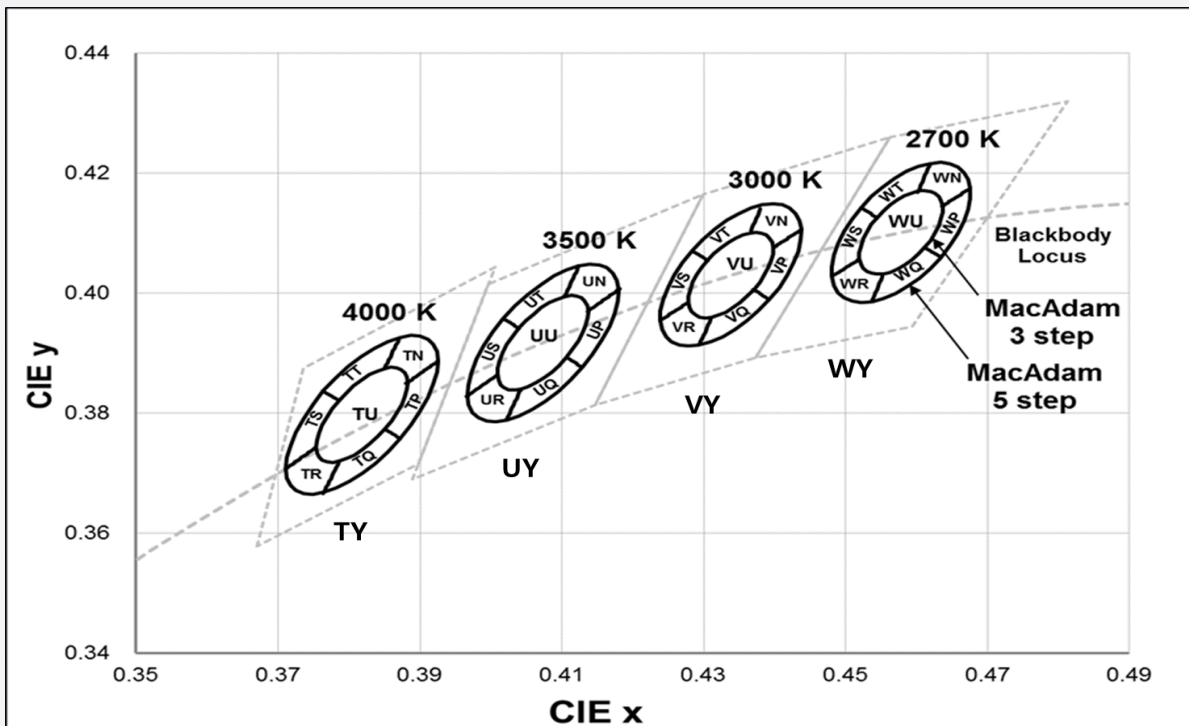

f) Chromaticity Region & Coordinates ( $I_f = 65 \text{ mA}$ ,  $T_s = 25^\circ\text{C}$ )

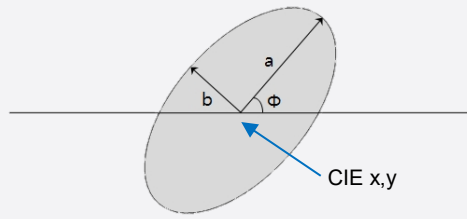

MacAdam	CCT (K)	Center point		Major-axis	Minor-axis	Rotation
		CIE x	CIE y	a	b	$\Phi$
3 step	2700	0.4578	0.4101	0.0081	0.0042	53.70
	3000	0.4338	0.4030	0.0083	0.0041	53.22
	3500	0.4073	0.3917	0.0093	0.0041	54.00
	4000	0.3818	0.3797	0.0094	0.0040	53.72
	5000	0.3447	0.3553	0.0082	0.0035	59.62
	5700	0.3287	0.3417	0.0075	0.0032	59.10
	6500	0.3123	0.3282	0.0067	0.0029	58.57
5 step	2700	0.4578	0.4101	0.0135	0.0070	53.70
	3000	0.4338	0.4030	0.0138	0.0068	53.22
	3500	0.4073	0.3917	0.0155	0.0068	54.00
	4000	0.3818	0.3797	0.0157	0.0067	53.72
	5000	0.3447	0.3553	0.0137	0.0058	59.62
	5700	0.3287	0.3417	0.0125	0.0053	59.10
	6500	0.3123	0.3282	0.0112	0.0048	58.57

**Note:** Samsung maintains measurement tolerance of:  $C_x, C_y = \pm 0.005$

## g) Chromaticity Region &amp; Coordinates

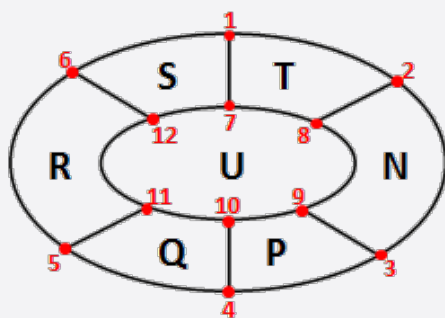

Region	2700K		3000K		3500K		4000K	
	CIE x	CIE y	CIE x	CIE y	CIE x	CIE y	CIE x	CIE y
1	0.4521	0.4142	0.4283	0.4071	0.4018	0.3957	0.3764	0.3837
2	0.4619	0.4216	0.4382	0.4146	0.4125	0.4046	0.3871	0.3926
3	0.4675	0.4175	0.4437	0.4105	0.4180	0.4005	0.3925	0.3887
4	0.4634	0.4059	0.4393	0.3989	0.4128	0.3877	0.3872	0.3758
5	0.4537	0.3986	0.4293	0.3913	0.4022	0.3788	0.3765	0.3668
6	0.4481	0.4028	0.4239	0.3954	0.3966	0.3828	0.3711	0.3707
7	0.4544	0.4126	0.4305	0.4054	0.4040	0.3941	0.3786	0.3821
8	0.4603	0.4170	0.4364	0.4100	0.4104	0.3994	0.3850	0.3874
9	0.4636	0.4145	0.4397	0.4075	0.4137	0.3970	0.3882	0.3851
10	0.4612	0.4076	0.4371	0.4005	0.4106	0.3893	0.3850	0.3773
11	0.4553	0.4032	0.4311	0.3960	0.4042	0.3840	0.3786	0.3720
12	0.4520	0.4057	0.4279	0.3984	0.4009	0.3864	0.3754	0.3743

Region	5000K		5700K		6500K	
	CIE x	CIE y	CIE x	CIE y	CIE x	CIE y
1	0.3397	0.3583	0.3242	0.3445	0.3082	0.3307
2	0.3482	0.3670	0.3320	0.3524	0.3153	0.3377
3	0.3532	0.3640	0.3365	0.3496	0.3194	0.3352
4	0.3497	0.3524	0.3333	0.3390	0.3164	0.3257
5	0.3412	0.3436	0.3254	0.3310	0.3093	0.3187
6	0.3362	0.3465	0.3209	0.3338	0.3052	0.3212
7	0.3417	0.3571	0.3260	0.3434	0.3098	0.3297
8	0.3468	0.3623	0.3307	0.3481	0.3141	0.3339
9	0.3498	0.3605	0.3334	0.3464	0.3166	0.3324
10	0.3477	0.3535	0.3314	0.3401	0.3148	0.3267
11	0.3426	0.3483	0.3267	0.3353	0.3105	0.3225
12	0.3396	0.3500	0.3240	0.3369	0.3080	0.3240

### 3. Typical Characteristics Graphs

#### a) Spectrum Distribution ( $I_f = 65 \text{ mA}$ , $T_s = 25 \text{ }^\circ\text{C}$ )

CCT : 2700K (80 CRI)

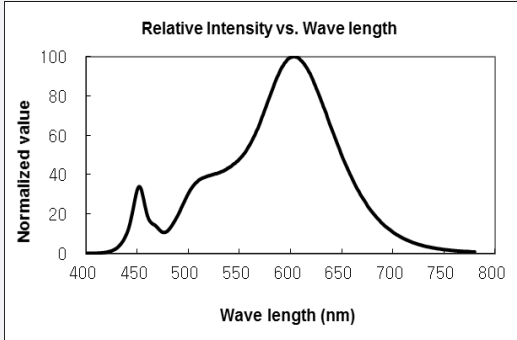

CCT : 3000K (80 CRI)

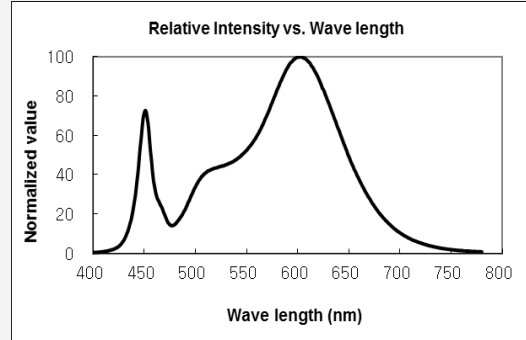

CCT : 3500K (80 CRI)

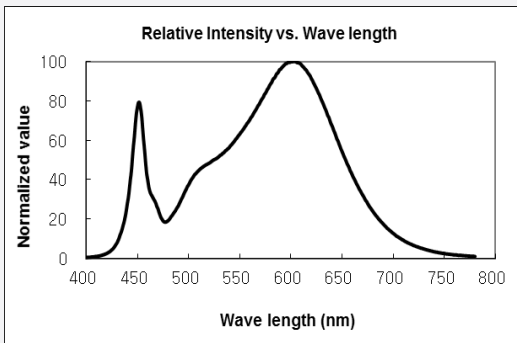

CCT : 4000K (80 CRI)

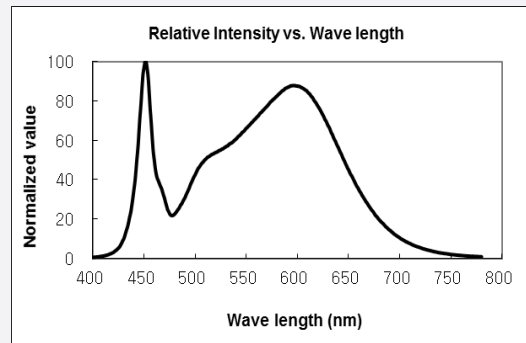

CCT : 5000K (80 CRI)

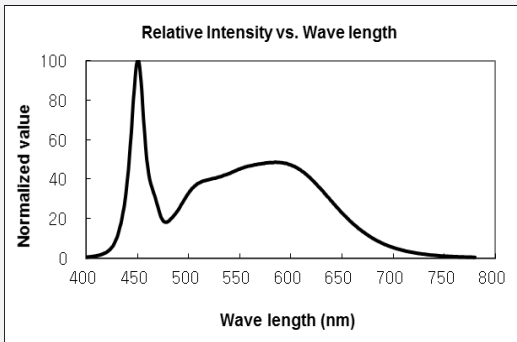

CCT : 5700K (80 CRI)

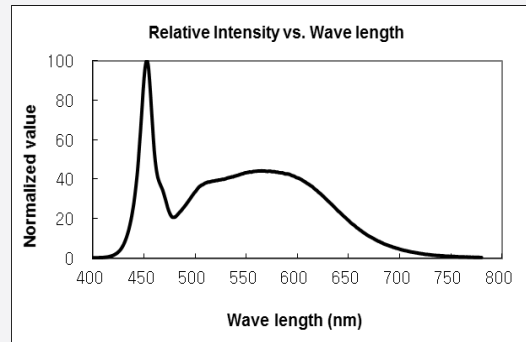

CCT : 6500K (80 CRI)

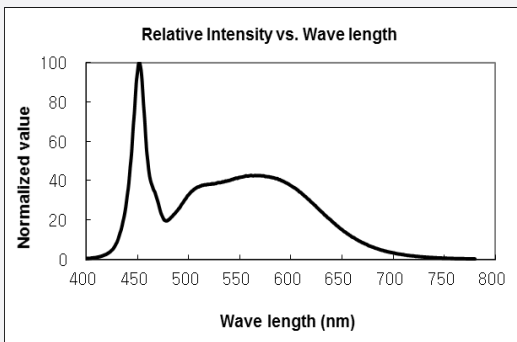

**b) Forward Current Characteristics ( $I_F = 65 \text{ mA}$ ,  $T_s = 25 \text{ }^\circ\text{C}$ )**

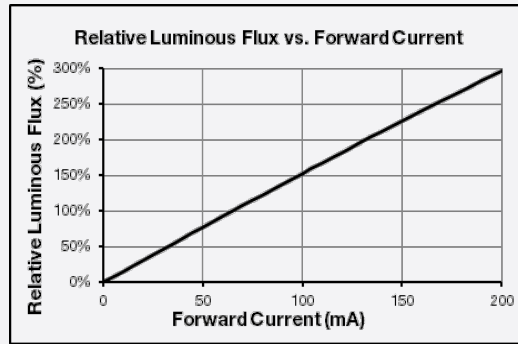
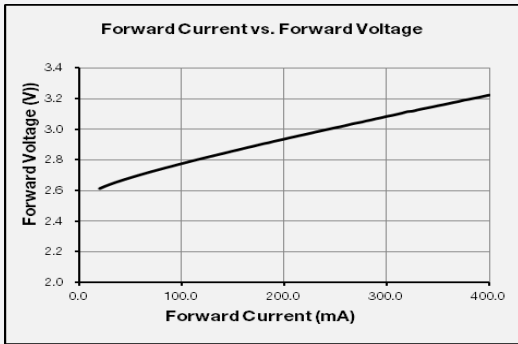

**c) Temperature Characteristics ( $I_F = 65 \text{ mA}$ )**

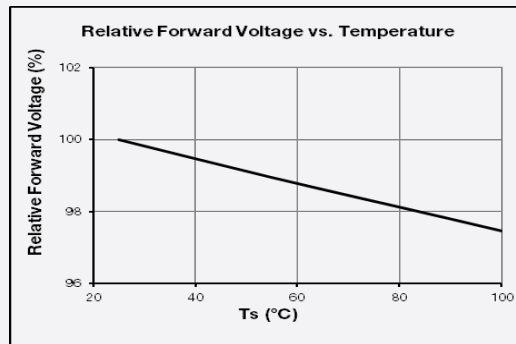
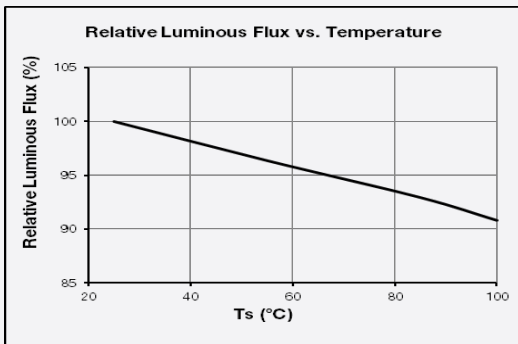

**d) Color Shift Characteristics ( $T_s = 25 \text{ }^\circ\text{C}$ ,  $I_F = 65 \text{ mA}$ )**

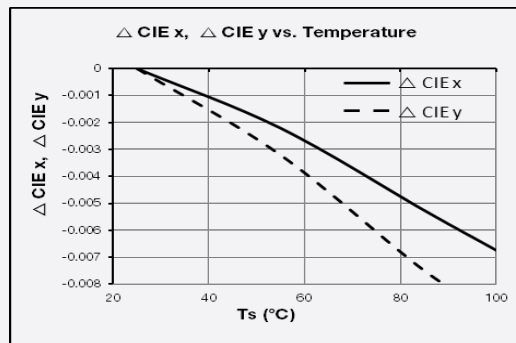
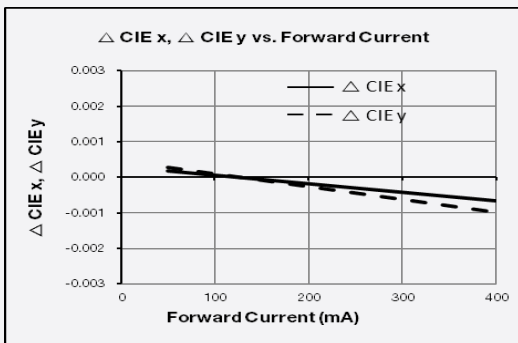

### e) Derating Curve

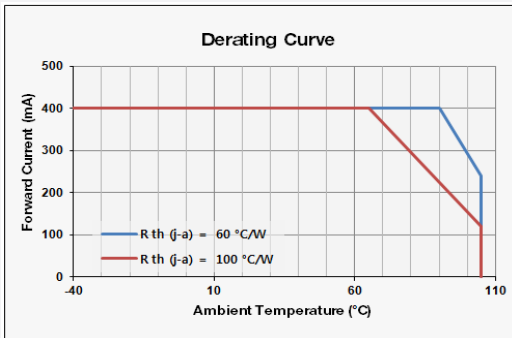

### f) Beam Angle Characteristics (IF=65mA, Ts=25 °C)

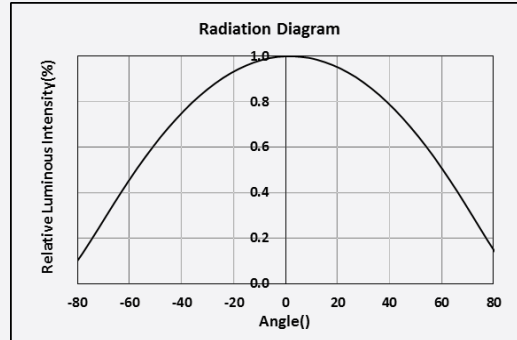

**Note:** All characteristics shown are for reference only.

Derating characteristics will meet the criteria as detailed in the Reliability section within this specification.

#### 4. Outline Drawing & Dimension

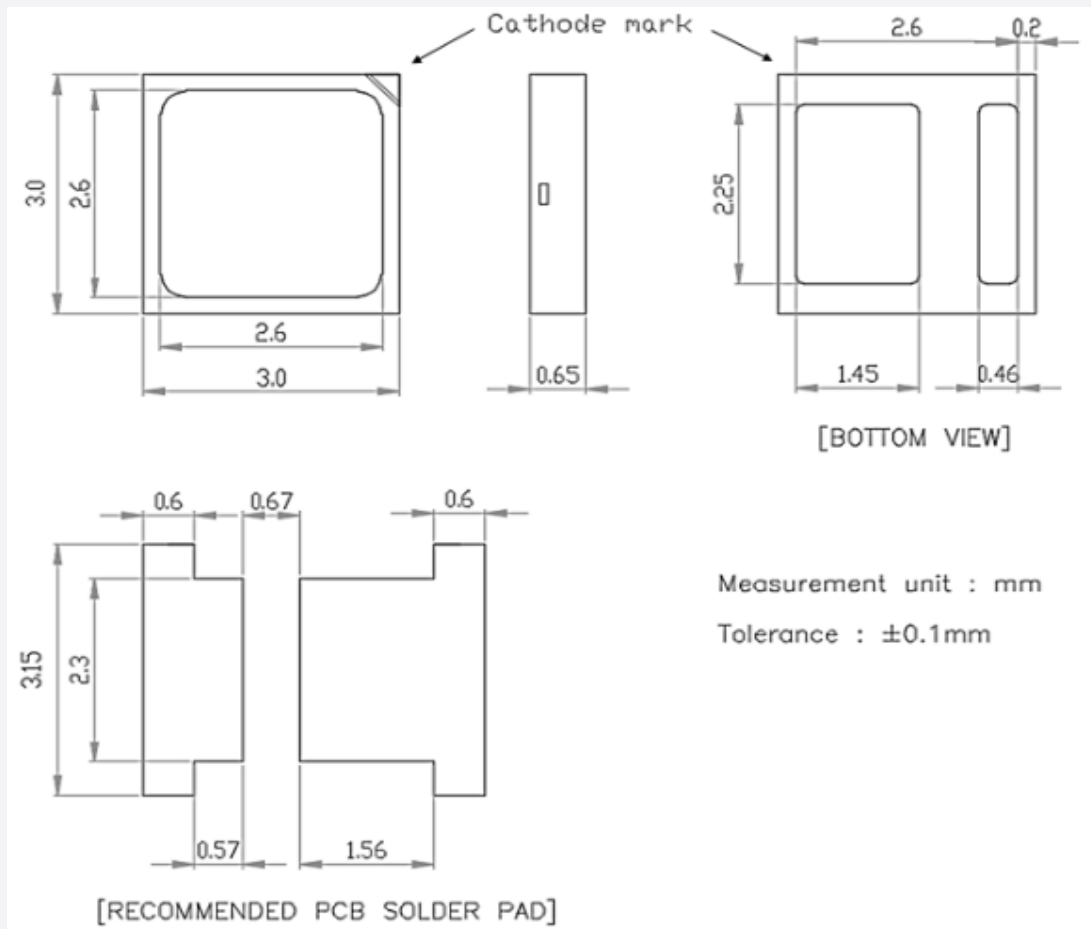

#### Notes:

- 1) This LED has built-in ESD protection device(s) connected in parallel to LED chip(s).
- 2)  $T_s$  point and measurement method:
  - ① Measure one point at the cathode pad, if necessary remove PSR of PCB to reach  $T_s$  point.
  - ② All pads must be soldered to the PCB to dissipate heat properly, otherwise the LED can be damaged.

#### Precautions:

- 1) Pressure on the LEDs will influence to the reliability of the LEDs. Precautions should be taken to avoid strong pressure on the LEDs. Do not put stress on the LEDs during heating.
- 2) Re-soldering should not be done after the LEDs have been soldered. If re-soldering is unavoidable, LED's characteristics should be carefully checked before and after such repair.
- 3) Do not stack assembled PCBs together. Since materials of LEDs is soft, abrasion between two PCB assembled with LED might cause catastrophic failure of the LEDs.

## 5. Reliability Test Items & Conditions

### a) Test Items

Test Item	Test Condition	Test Hour / Cycle	Sample No.
High Temperature Life Test	85 °C, DC Max current	1000 h	22
High Temperature Humidity Life Test	60 °C, 90 % RH, DC Max current	1000 h	22
Low Temperature Life Test	-40 °C, DC Max current	1000 h	22
Thermal Cycle	-45 °C / 15 min ↔ 125 °C / 15 min → Hot plate 180 °C	500 cycles	100
High Temperature Storage	120 °C	1000 h	11
Low Temperature Storage	-40 °C	1000 h	11

ESD (HBM)

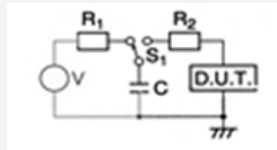

R<sub>1</sub>: 10 MΩ  
 R<sub>2</sub>: 1.5 kΩ  
 C: 100 pF  
 V: ±5 kV

5 times

30

### b) Criteria for Judging the Damage

Item	Symbol	Test Condition (T <sub>s</sub> = 25 °C)	Limit	
			Min	Max
Forward Voltage	V <sub>F</sub>	I <sub>F</sub> = 65 mA	Init. Value * 0.9	Init. Value * 1.1
Luminous Flux	Φ <sub>v</sub>	I <sub>F</sub> = 65 mA	Init. Value * 0.7	Init. Value * 1.1

## 6. Soldering Conditions

### a) Reflow Conditions (Pb free)

Reflow frequency: 2 times max.

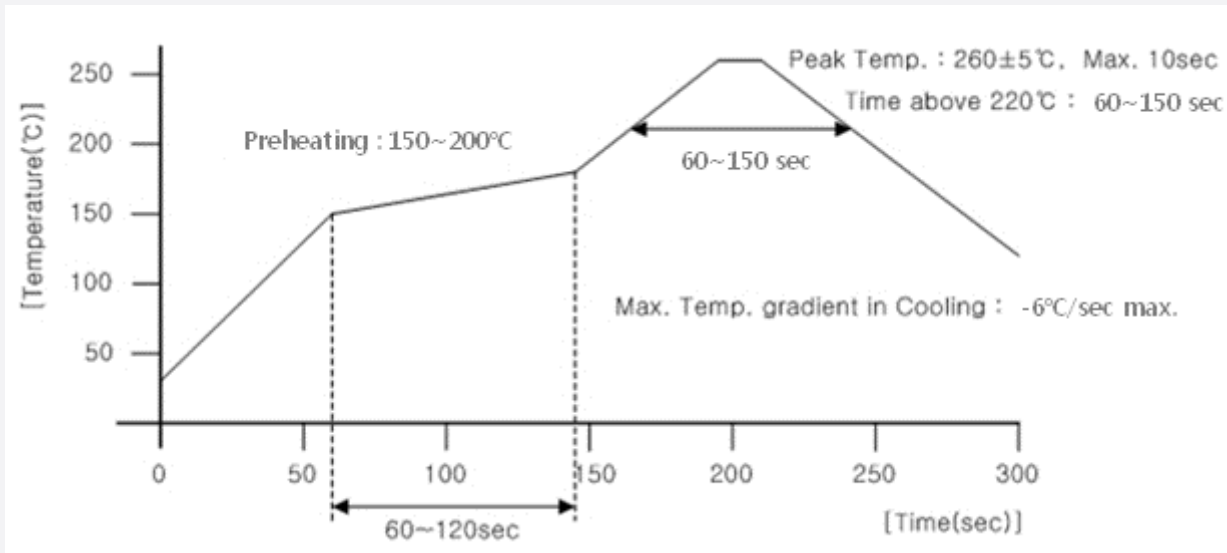

### b) Manual Soldering Conditions

Not more than 5 seconds @ max. 300 °C, under soldering iron.

## 7. Tape & Reel

### a) Taping Dimension

(unit: mm)

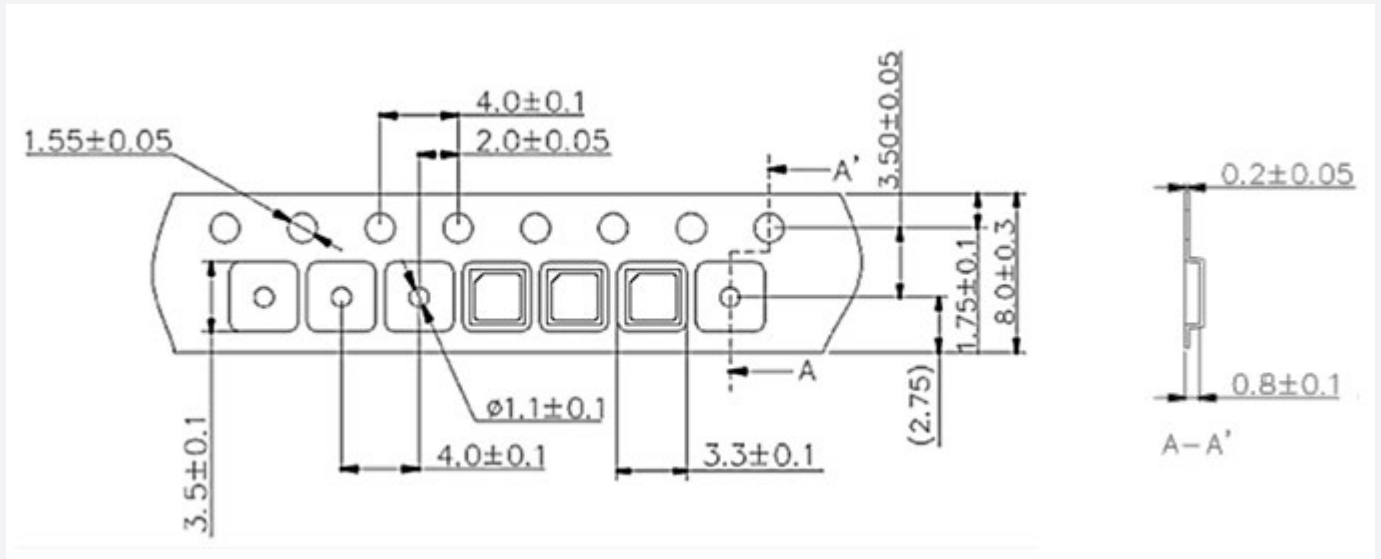

Taping Direction

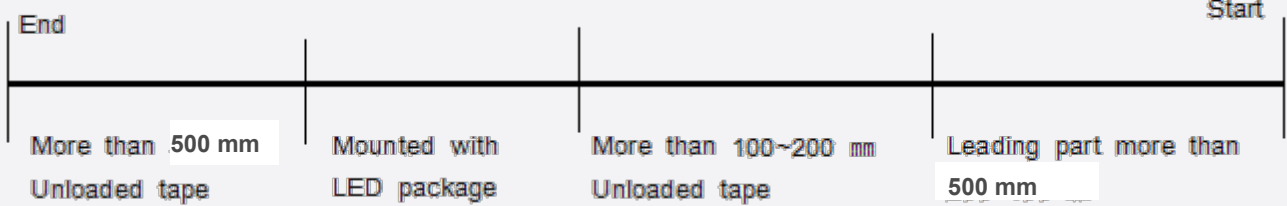
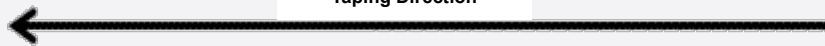

## b) Reel Dimension

(unit: mm)

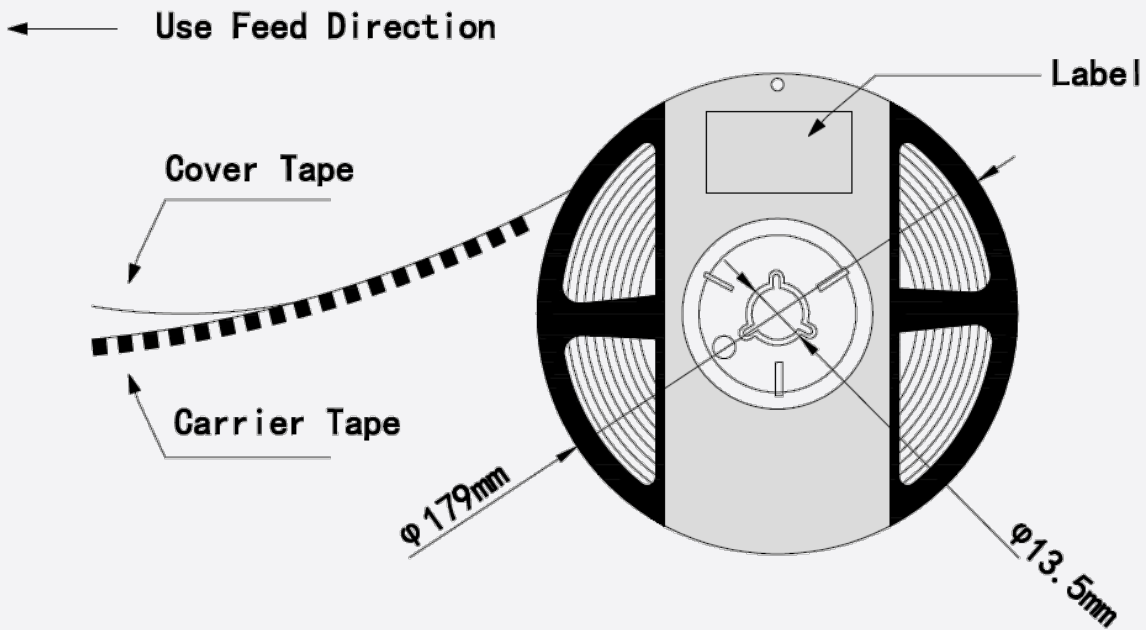
**Notes:**

- 1) Quantity: The quantity/reel is 4,000 pcs
- 2) Cumulative Tolerance: Cumulative tolerance / 10 pitches is  $\pm 0.2$  mm
- 3) Adhesion Strength of Cover Tape: Adhesion strength is 0.1-0.7 N when the cover tape is turned off from the carrier tape at  $10^\circ$  angle to the carrier tape
- 4) Packaging: P/N, Manufacturing data code no. and quantity are indicated on the aluminum packing bag

## 8. Label Structure

### a) Label Structure

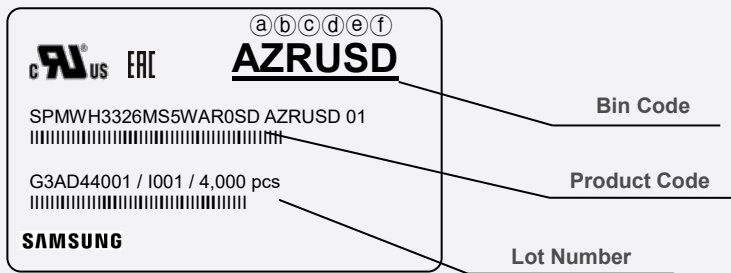

Note: Denoted bin code and product code above is only an example (see description on page 5)

Bin Code:

- ⒶⒷ: Forward Voltage bin (refer to page 8)
- ⒸⒹ: Chromaticity bin (refer to page 10-13)
- ⒺⒻ: Luminous Flux bin (refer to page 8)

### b) Lot Number

The lot number is composed of the following characters:



①②③③②③④⑤⑥⑦⑧⑨ / IⒶⒷⒸ / 4,000 pcs

- ①② : Production site (G3 : Shenzhen, China)
- ③ : Product state (A: Normal, B: Bulk, C: First Production, R: Reproduction, S: Sample)
- ④ : Year (C : 2018, D : 2019, E : 2020 ...)
- ⑤ : Month (1~9, A, B, C)
- ⑥ : Day (1~9, A, B~V)
- ⑦⑧⑨ : Serial number (001 ~ 999)
- ⒶⒷⒸ : Product serial number (001 ~ 999)

## 9. Packing Structure

### a) Packing Process (The quantity of PKG on the Reel to be Max 4,000pcs)

#### Reel

 **ERIC** **AZRUSD**  
 SPMWH3326MS5WAR0SD AZRUSD 01  
 G3AD44001 / I001 / 4,000 pcs  
**SAMSUNG**

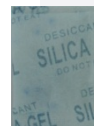
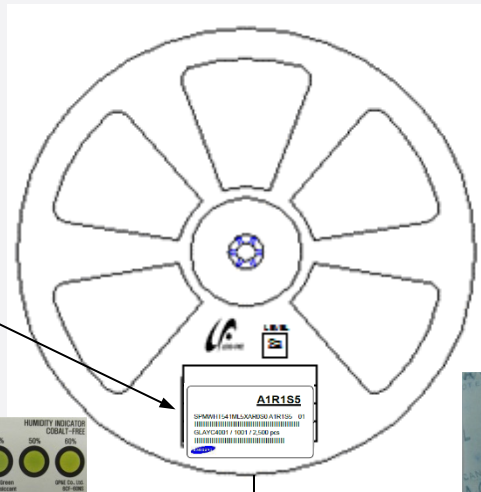

#### Aluminum Vinyl Packing Bag

 **ERIC** **AZRUSD**  
 SPMWH3326MS5WAR0SD AZRUSD 01  
 G3AD44001 / I001 / 4,000 pcs  
**SAMSUNG**



#### Outer Box

Material: Paper (SW3B(B))

Type	Size (mm)			Note
	L	W	H	
7 inch L	245 ± 5	220 ± 5	182 ± 5	Up to 10 reels
7 inch S	245 ± 5	220 ± 5	86 ± 5	Up to 5 reels

#### ① Side Label

 **ERIC** **AZRUSD**  
 SPMWH3326MS5WAR0SD AZRUSD 01  
 G3AD44001 / I001 / 40,000 pcs  
**SAMSUNG**

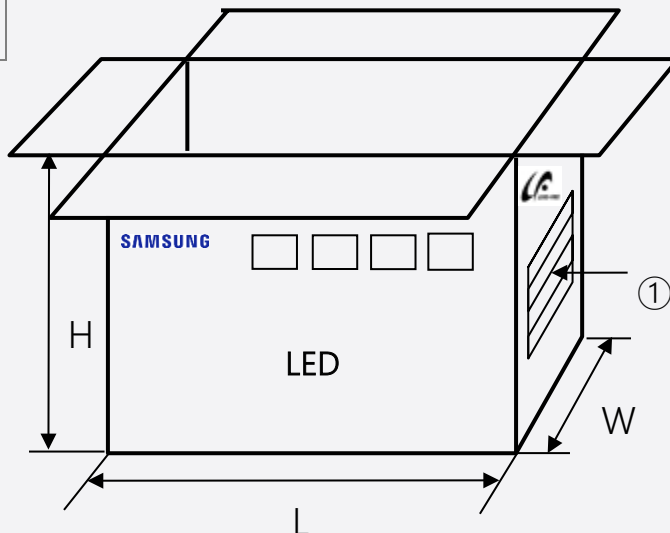

b) Packing Process for kitting (The quantity of PKG on the Reel to be Max 4,000pcs)

Kitting 'A'

**ERC** **AZ★NSD**  
 SPMWH3326MS5WA★YSD AZ★NSD 01  
 G3AD44001 / I001 / 4,000 pcs  
**SAMSUNG**

Kitting 'B'

**ERC** **AZ★RSD**  
 SPMWH3326MS5WA★YSD AZ★RSD 01  
 G3AD44001 / I001 / 4,000 pcs  
**SAMSUNG**

Aluminum Vinyl Packing Bag

Kitting 'A'

**ERC** **AZ★NSD**  
 SPMWH3326MS5WA★YSD AZ★NSD 01  
 G3AD44001 / I001 / 4,000 pcs  
**SAMSUNG**

Kitting 'B'

**ERC** **AZ★RSD**  
 SPMWH3326MS5WA★YSD AZ★RSD 01  
 G3AD44001 / I001 / 4,000 pcs  
**SAMSUNG**

Outer Box

Kitting 'A'

**ERC** **AZ★NSD**  
 SPMWH3326MS5WA★YSD AZ★NSD 01  
 G3AD44001 / I001 / 40,000 pcs  
**SAMSUNG** [BOX Label]

Kitting 'B'

**ERC** **AZ★RSD**  
 SPMWH3326MS5WA★YSD AZ★RSD 01  
 G3AD44001 / I001 / 40,000 pcs  
**SAMSUNG** [BOX Label]

Note: "★" can be Nominal CCT code.

Material: Paper (SW3B(B))

Type	Size (mm)			Note
	L	W	H	
7 inch L	245 ± 5	220 ± 5	182 ± 5	Up to 10 reels

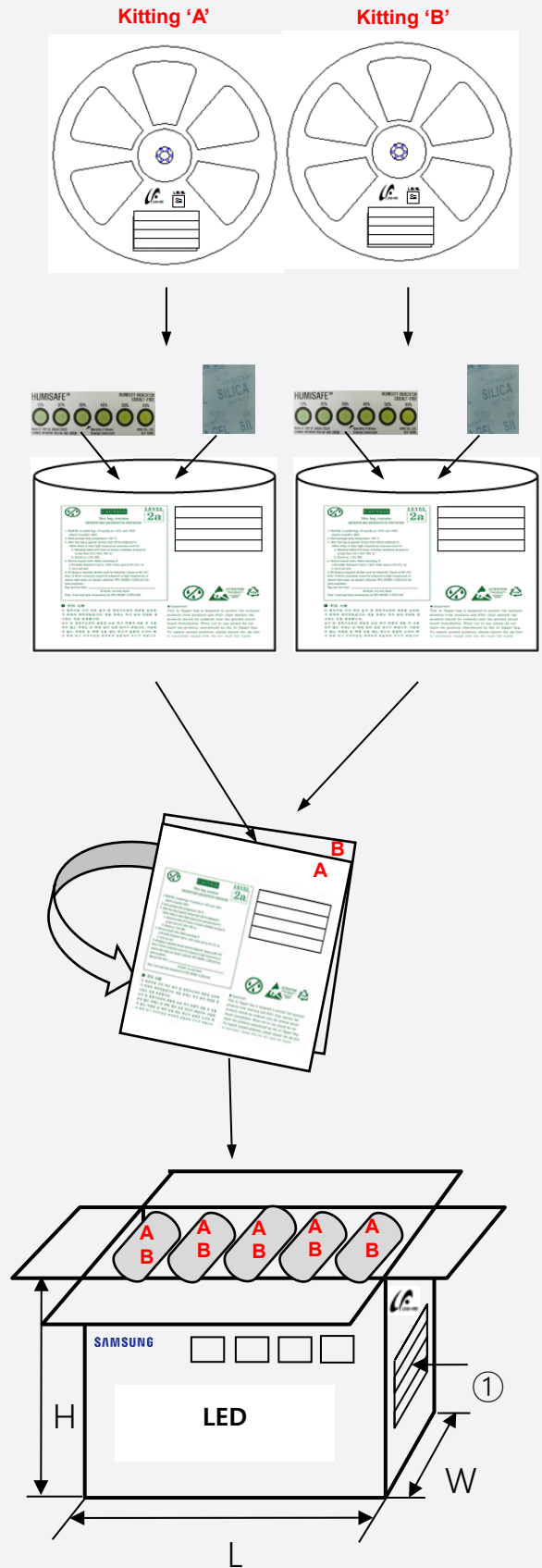

c) Aluminum Vinyl Packing Bag



**CAUTION**

This bag contains  
**MOISTURE SENSITIVE DEVICES**

**LEVEL**

2a

**cRU** us EBC **AZRUSD**

SPMWH3326MS5WAR0SD AZRUSD 01  
 |||  
 G3AD44001 / I001 / 4,000 pcs  
 |||  
**SAMSUNG**





1. Shelf life in sealed bag: 12 months at <40°C and <90% relative humidity (RH)

2. Peak package body temperature: 240 °C

3. After this bag is opened, devices that will be subjected to reflow solder or other high temperature processes must be:

a. Mounted within 672 hours at factory conditions of equal to or less than 30°C /60% RH, or

b. Stored at <10% RH

4. Devices require bake, before mounting, if:

a. Humidity Indicator Card is >60% when read at 23±5°C, or

b. 2a is not met.

5. If baking is required, devices must be baked for 10 ~ 24 hours at 60±5°C

Note: If device containers cannot be subjected to high temperature or shorter bake times are desired, reference IPC/JEDEC J-STD-033 for bake procedure,

Bag seal due date: \_\_\_\_\_  
 (If blank, see code label)

Note: Level and body temperature by IPC/JEDEC J-STD-020

**■ 주의 사항**

이 알루미늄 지퍼 백은 습기 및 정전기로부터 제품을 보호하기 위하여 제작되었습니다. 개봉 후에는 즉시 솔더 작업을 실시하는 것을 권장합니다.

습기 및 정전기로부터 제품을 보호 하기 위해서 개봉 후 사용하지 않는 자재는 본 팩에 넣어 보관 하시기 바랍니다. 사용하지 않는 자재를 본 팩에 넣을 때는 반드시 동봉된 드라이 팩과 함께 넣고 지퍼부분을 완전하게 밀봉하여 주시기 바랍니다.

**■ Important**

This Al Zipper bag is designed to protect the enclosed products from moisture and ESD. Once opened, the products should be soldered onto the printed circuit board immediately. When not in use, please do not leave the products unprotected by the Al Zipper Bag. To repack unused products., please ensure the zip-lock is completely sealed with the dry pack left inside.

d) Silica Gel & Humidity Indicator Card inside Aluminum Vinyl Bag

(This image is for reference only. Silicagel and humidity indicator shapes may be different.)



## 10. Precautions in Handling & Use

- 1) For over-current protection, users are recommended to apply resistors connected in series with the LEDs to mitigate sudden change of the forward current caused by shift of forward voltage.
- 2) This device should not be used in any type of fluid such as water, oil, organic solvent, etc. When cleaning is required, IPA is recommended as the cleaning agent. Some solvent-based cleaning agent may damage the silicone resins used in the device.
- 3) When the device is in operation, the forward current should be carefully determined considering the maximum ambient temperature and corresponding junction temperature.
- 4) LEDs must be stored in a clean environment. Shelf life of sealed bags is 12 months at temperature 0~40 °C, 0~90 % RH.
- 5) After storage bag is opened, device subjected to soldering, solder reflow, or other high temperature processes must be:
  - a. Mounted within 672 hours (28 days) at an assembly line with a condition of no more than 30 °C / 60 % RH\*<sup>Note 1</sup>, or
  - b. Mounted within 24 hours (1 day) at an assembly line with a condition of more than 30 °C / 70 % RH\*<sup>Note 2</sup>, or
  - c. Stored at <10 % RH.

\*Note 1, 2: IPC/JEDEC J-STD-033A, Recommended Equivalent Total Floor Life Table

Package Type and Body Thickness	Moisture Sensitivity Level	Maximum Percent Relative Humidity						Temperature
		40%	50%	60%	70%	80%	90%	
Body Thickness <2.1mm	Level 2a	∞	∞	28	1	1	1	30°C
		∞	∞	∞	2	1	1	25°C
		∞	∞	∞	2	2	1	20°C

- 6) Repack unused devices with anti-moisture packing, fold to close any opening and then store in a dry place.
- 7) Devices require baking before mounting, if humidity card reading is >60 % at 23 ± 5 °C.
- 8) Devices must be baked for 10~24 hours at 60 ± 5 °C, if baking is required.
- 9) The LEDs are sensitive to the static electricity and surge current. It is recommended to use a wrist band or anti-electrostatic glove when handling the LEDs. If voltage exceeding the absolute maximum rating is applied to LEDs, it may cause damage or even destruction to LED devices. Damaged LEDs may show some unusual characteristics such as increase in leakage current, lowered turn-on voltage, or abnormal lighting of LEDs at low current.
- 10) VOCs (Volatile Organic Compounds) can be generated from adhesives, flux, hardener or organic additives used in luminaires (fixtures). Transparent LED silicone encapsulant is permeable to those chemicals and they may lead to a discoloration of encapsulant when they exposed to heat or light. This phenomenon can cause a significant loss of light emitted (output) from the luminaires. In order to prevent these problems, we recommend users to know the physical properties of materials used in luminaires and they must be carefully selected.
- 11) Risk of sulfurization (or tarnishing)  
 The LED from Samsung uses a silver-plated lead frame and its surface color may change to black (or dark colored) when it is exposed to sulfur (S), chlorine (Cl) or other halogen compound. Sulfurization of lead frame may cause intensity degradation, change of chromaticity coordinates and, in extreme cases, open circuit. It requires caution. Due to possible sulfurization of lead frame, LED should not be used and stored together with oxidizing substances made of materials such as rubber, plain paper, lead solder cream, etc.

# Legal and additional information.

## [About Samsung Electronics Co., Ltd.](#)

Samsung inspires the world and shapes the future with transformative ideas and technologies.

The company is redefining the worlds of TVs, smartphones, wearable devices, tablets, digital appliances, network systems, and memory, system LSI, foundry and LED solutions. For the latest news, please visit the Samsung Newsroom at [news.samsung.com](http://news.samsung.com).

Copyright © 2018 Samsung Electronics Co., Ltd. All rights reserved.

Samsung is a registered trademark of Samsung Electronics Co., Ltd.

Specifications and designs are subject to change without notice. Non-metric weights and measurements are approximate. All data were deemed correct at time of creation. Samsung is not liable for errors or omissions. All brand, product, service names and logos are trademarks and/or registered trademarks of their respective owners and are hereby recognized and acknowledged.

Samsung Electronics Co., Ltd.

95, Samsung 2-ro

Giheung-gu

Yongin-si, Gyeonggi-do, 446-711



KOREA

[www.samsungled.com](http://www.samsungled.com)



**SAMSUNG**

## Looking for pricing, stock, or lifecycle information?

Click below to explore more details on WIN SOURCE:

-  [View SPMWH3326MS5WAT3SD on WIN SOURCE](#)
-  [Samsung Information](#)

## Optimize Your Supply Chain with WIN SOURCE Solutions

-  Global Sourcing Solution
-  Obsolete Management
-  Cost Control Management
-  Shortage Management
-  Alternative Solution
-  Excess Inventory Management