



**THE DATASHEET OF
SPMWH3326MD5WAPYSA**



Middle Power LED Series
3030

LM301Z
CRI 80



Features & Benefits

- 0.3 W class middle power LED
- EMC resin for high reliability
- Standard form factor for design flexibility (3.0 × 3.0 mm)



Table of Contents

1.	Characteristics	-----	3
2.	Product Code Information	-----	4
3.	Typical Characteristics Graphs	-----	11
4.	Outline Drawing & Dimension	-----	13
5.	Reliability Test Items & Conditions	-----	14
6.	Soldering Conditions	-----	15
7.	Tape & Reel	-----	16
8.	Label Structure	-----	18
9.	Packing Structure	-----	19
10.	Precautions in Handling & Use	-----	22

1. Characteristics

a) Absolute Maximum Rating

Item	Symbol	Rating	Unit	Condition
Ambient / Operating Temperature	T_a	-40 ~ +85	°C	-
Storage Temperature	T_{stg}	-40 ~ +100	°C	-
LED Junction Temperature	T_j	125	°C	-
Forward Current	I_F	400	mA	-
Pulse Forward Current	I_{FP}	600	mA	Duty 1/10, pulse width 10 ms
Assembly Process Temperature	-	260 <10	°C s	-
ESD (HBM)	-	5	kV	-

b) Electro-optical Characteristics ($I_F = 65 \text{ mA}$, $T_s = 25 \text{ °C}$)

Item	Nominal CCT (K)	Rank	Bin	Min.	Typ.	Max.	Unit
Forward Voltage (V_F)		WA	AY	2.6	-	2.7	V
			AZ	2.7	-	2.8	
			A1	2.8	-	2.9	
Reverse Voltage (@ 5 mA)				0.7	-	1.2	V
Color Rendering Index (R_a)		5		80	-	-	-
Special CRI (R9)				-	-	-	-
Thermal Resistance (junction to solder point)				-	12	-	°C/W
Beam Angle				-	120	-	°

Note:

Samsung maintains measurement tolerance of: forward voltage = $\pm 0.1 \text{ V}$, luminous flux = $\pm 5 \%$, CRI = ± 3 , R9 = ± 6.5

2. Product Code Information

1	2	3	4	5	6	7	8	9	10	11	12	13	14	15	16	17	18
S	P	M	W	H	3	3	2	6	M	D	5	W	A	V	0	S	A

Digit	PKG Information	Code	Specification																											
1 2 3	Samsung Package Middle Power	SPM																												
4 5	Color	WH	White																											
6	Product Version	3	Zener version																											
7 8 9	Form Factor	326	3.0 x 3.0 x 0.65 mm; 2 pads																											
10	Sorting Current	M	65 mA																											
11	Chromaticity Coordinates	D	MacAdam																											
12	CRI	5	Min. 80																											
13 14	Forward Voltage (V)	WA	<table> <tr> <td>AY</td><td>2.6~2.7</td></tr> <tr> <td>Bin Code: AZ</td><td>2.7~2.8</td></tr> <tr> <td>A1</td><td>2.8~2.9</td></tr> </table>	AY	2.6~2.7	Bin Code: AZ	2.7~2.8	A1	2.8~2.9																					
AY	2.6~2.7																													
Bin Code: AZ	2.7~2.8																													
A1	2.8~2.9																													
15 16	CCT (K)	<table> <tr><td>Y☆</td><td>2200</td><td>YN, YP, YQ, YR, YS, YT, YU</td></tr> <tr><td>X☆</td><td>2500</td><td>XN, XP, XQ, XR, XS, XT, XU</td></tr> <tr><td>W☆</td><td>2700</td><td>WN, WP, WQ, WR, WS, WT, WU</td></tr> <tr><td>V☆</td><td>3000</td><td>VN, VP, VQ, VR, VS, VT, VU</td></tr> <tr><td>U☆</td><td>3500</td><td>Bin Code: UN, UP, UQ, UR, US, UT, UU</td></tr> <tr><td>T☆</td><td>4000</td><td>TN, TP, TQ, TR, TS, TT, TU</td></tr> <tr><td>R☆</td><td>5000</td><td>RN, RP, RQ, RR, RS, RT, RU</td></tr> <tr><td>Q☆</td><td>5700</td><td>QN, QP, QQ, QR, QS, QT, QU</td></tr> <tr><td>P☆</td><td>6500</td><td>PN, PP, PQ, PR, PS, PT, PU</td></tr> </table> <p>☆ : "0" (Whole Bin) "3" (MacAdam 3- step) "Y" (Kitting)</p>	Y ☆	2200	YN, YP, YQ, YR, YS, YT, YU	X ☆	2500	XN, XP, XQ, XR, XS, XT, XU	W ☆	2700	WN, WP, WQ, WR, WS, WT, WU	V ☆	3000	VN, VP, VQ, VR, VS, VT, VU	U ☆	3500	Bin Code: UN, UP, UQ, UR, US, UT, UU	T ☆	4000	TN, TP, TQ, TR, TS, TT, TU	R ☆	5000	RN, RP, RQ, RR, RS, RT, RU	Q ☆	5700	QN, QP, QQ, QR, QS, QT, QU	P ☆	6500	PN, PP, PQ, PR, PS, PT, PU	
Y ☆	2200	YN, YP, YQ, YR, YS, YT, YU																												
X ☆	2500	XN, XP, XQ, XR, XS, XT, XU																												
W ☆	2700	WN, WP, WQ, WR, WS, WT, WU																												
V ☆	3000	VN, VP, VQ, VR, VS, VT, VU																												
U ☆	3500	Bin Code: UN, UP, UQ, UR, US, UT, UU																												
T ☆	4000	TN, TP, TQ, TR, TS, TT, TU																												
R ☆	5000	RN, RP, RQ, RR, RS, RT, RU																												
Q ☆	5700	QN, QP, QQ, QR, QS, QT, QU																												
P ☆	6500	PN, PP, PQ, PR, PS, PT, PU																												
17 18	Luminous Flux (lm)	SA	<table> <tr> <td>Bin Code:</td><td>SA</td></tr> </table>	Bin Code:	SA																									
Bin Code:	SA																													

a) Luminous Flux Bins ($I_F = 65 \text{ mA}$, $T_s = 25 \text{ °C}$)

Nominal CCT (K)	CRI Min.	Product Code	Flux Bin	Flux Range (Φ_v , lm)
2200	80	SPMWH3326MD5WAY☆SA	SA	26.0 – 29.0
2500	80	SPMWH3326MD5WAX☆SA	SA	28.0 – 31.0
2700	80	SPMWH3326MD5WAW☆SA	SA	29.0 – 32.0
3000	80	SPMWH3326MD5WAV☆SA	SA	30.0 – 33.0
3500	80	SPMWH3326MD5WAU☆SA	SA	30.5 – 33.5
4000	80	SPMWH3326MD5WAT☆SA	SA	31.0 – 34.0
5000	80	SPMWH3326MD5WAR☆SA	SA	33.0 – 36.0
5700	80	SPMWH3326MD5WAQ☆SA	SA	31.0 – 34.0
6500	80	SPMWH3326MD5WAP☆SA	SA	31.0 – 34.0

Note:

"☆" can be "0" (Whole Bin), "3" (MacAdam 3-step), "Y" (Kitting)

b) Kitting Rule

1) Y Kitting bin Concept

1. Under agreement between customer and SAMSUNG ELECTRONICS, SAMSUNG can supply kitting bin (VF, Color, Im).
2. A forward voltage (VF) of kitting bin is combined by a pair of same VF rank such as (A2+A2) or (A3+A3).
3. A Chromaticity Coordinates of kitting bin is mixed by kitting procedure.(below kitting simulation)

[Kitting example]



[Binning Information]

	Bin #1	Bin #2
VF	AY	AY
	AZ	AZ
	A1	A1
CIE	U	U
	N	R
	P	S
	Q	T

c) Color Bins ($I_F = 65 \text{ mA}$, $T_s = 25 \text{ }^\circ\text{C}$)

Nominal CCT (K)	CRI	Product Code	Color Rank	Chromaticity Bins
2200	80	SPMWH3326MD5WAY0SA	Y0 (Whole Bin)	YN, YP, YQ, YR, YS, YT, YU
		SPMWH3326MD5WAY3SA	Y3 (MacAdam 3-step)	YU
		SPMWH3326MD5WAYYSA	YY (Kitting)	YN, YP, YQ, YR, YS, YT, YU
2500	80	SPMWH3326MD5WAX0SA	X0 (Whole Bin)	XN, XP, XQ, XR, XS, XT, XU
		SPMWH3326MD5WAX3SA	X3 (MacAdam 3-step)	XU
		SPMWH3326MD5WAXYSA	XY (Kitting)	XN, XP, XQ, XR, XS, XT, XU
2700	80	SPMWH3326MD5WAW0SA	W0 (Whole Bin)	WN, WP, WQ, WR, WS, WT, WU
		SPMWH3326MD5WAW3SA	W3 (MacAdam 3-step)	WU
		SPMWH3326MD5WAWYSA	WY (Kitting)	WN, WP, WQ, WR, WS, WT, WU
3000	80	SPMWH3326MD5WAV0SA	V0 (Whole Bin)	VN, VP, VQ, VR, VS, VT, VU
		SPMWH3326MD5WAV3SA	V3 (MacAdam 3-step)	VU
		SPMWH3326MD5WAVYSA	VY (Kitting)	VN, VP, VQ, VR, VS, VT, VU
3500	80	SPMWH3326MD5WAU0SA	U0 (Whole Bin)	UN, UP, UQ, UR, US, UT, UU
		SPMWH3326MD5WAU3SA	U3 (MacAdam 3-step)	UU
		SPMWH3326MD5WAUYSA	UY (Kitting)	UN, UP, UQ, UR, US, UT, UU
4000	80	SPMWH3326MD5WAT0SA	T0 (Whole Bin)	TN, TP, TQ, TR, TS, TT, TU
		SPMWH3326MD5WAT3SA	T3 (MacAdam 3-step)	TU
		SPMWH3326MD5WATYSA	TY (Kitting)	TN, TP, TQ, TR, TS, TT, TU
5000	80	SPMWH3326MD5WAR0SA	R0 (Whole Bin)	RN, RP, RQ, RR, RS, RT, RU
		SPMWH3326MD5WAR3SA	R3 (MacAdam 3-step)	RU
		SPMWH3326MD5WARYSA	RY (Kitting)	RN, RP, RQ, RR, RS, RT, RU
5700	80	SPMWH3326MD5WAQ0SA	Q0 (Whole Bin)	QN, QP, QQ, QR, QS, QT, QU
		SPMWH3326MD5WAQ3SA	Q3 (MacAdam 3-step)	QU
		SPMWH3326MD5WAQYSA	QY (Kitting)	QN, QP, QQ, QR, QS, QT, QU
6500	80	SPMWH3326MD5WAP0SA	P0 (Whole Bin)	PN, PP, PQ, PR, PS, PT, PU
		SPMWH3326MD5WAP3SA	P3 (MacAdam 3-step)	PU
		SPMWH3326MD5WAPYSA	PY (Kitting)	PN, PP, PQ, PR, PS, PT, PU

d) Voltage Bins ($I_F = 65 \text{ mA}$, $T_s = 25 \text{ }^\circ\text{C}$)

Nominal CCT (K)	CRI Min	Product Code	Voltage Rank	Voltage Bin	Voltage Range (V)
-	-	-	WA	AY	2.6 ~ 2.7
-	-	-		AZ	2.7 ~ 2.8
-	-	-		A1	2.8 ~ 2.9

e) Chromaticity Region & Coordinates ($I_F = 65 \text{ mA}$, $T_s = 25 \text{ }^\circ\text{C}$)

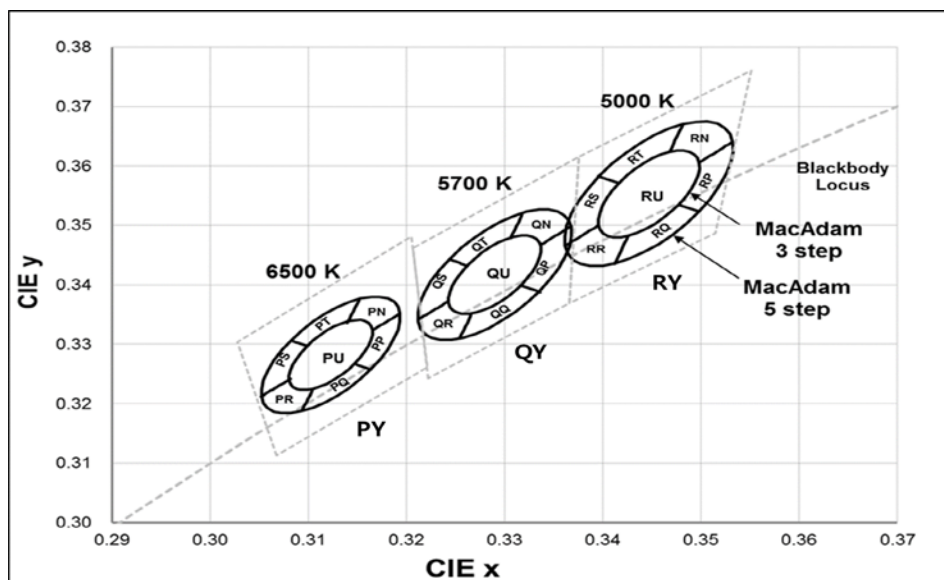
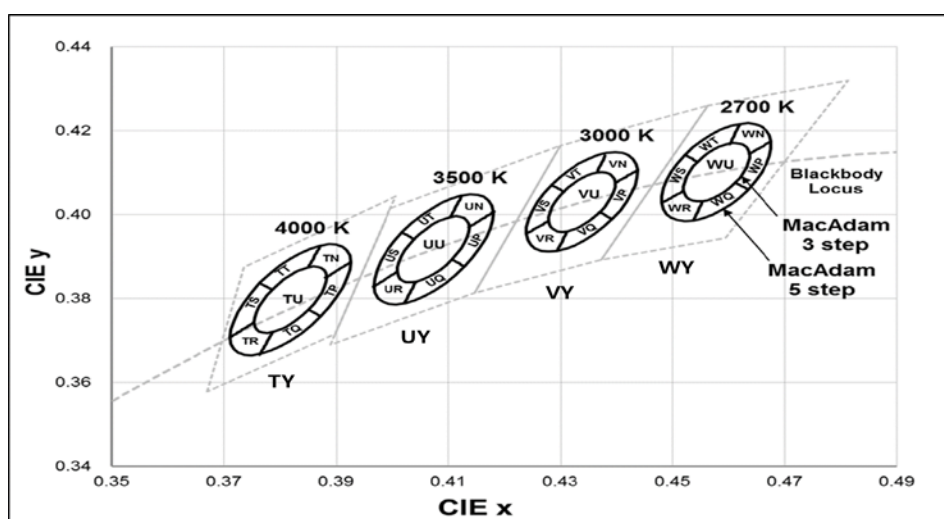
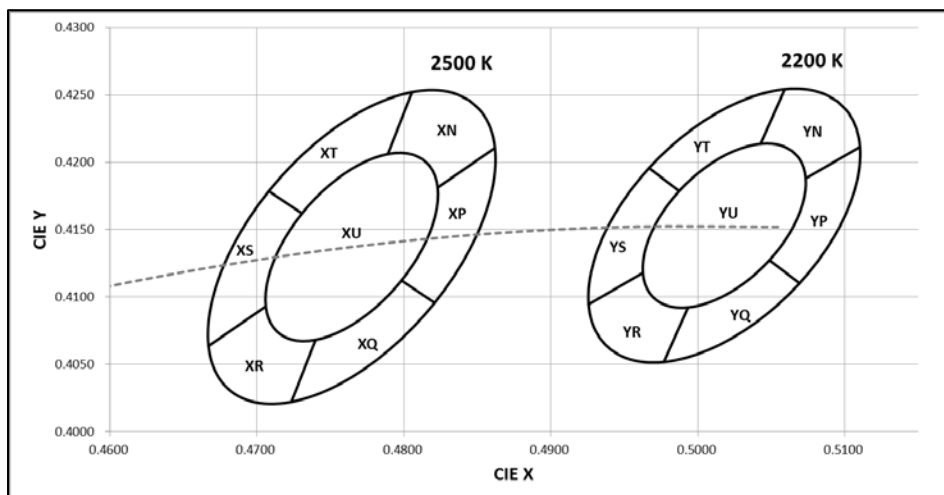

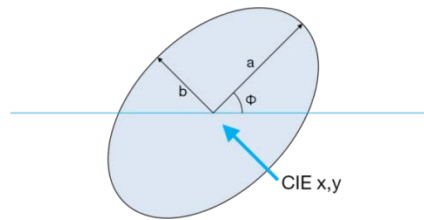
f) Chromaticity Region & Coordinates ($I_F = 65 \text{ mA}$, $T_s = 25 \text{ }^\circ\text{C}$)

MacAdam	CCT (K)	Center point		Major-axis	Minor-axis	Rotation
		CIE x	CIE y	a	b	Φ
3 step	2200	0.5018	0.4153	0.0024	0.0013	50.11
	2500	0.4765	0.4137	0.0027	0.0014	53.7
	2700	0.4578	0.4101	0.0081	0.0042	53.70
	3000	0.4338	0.4030	0.0083	0.0041	53.22
	3500	0.4073	0.3917	0.0093	0.0041	54.00
	4000	0.3818	0.3797	0.0094	0.0040	53.72
	5000	0.3447	0.3553	0.0082	0.0035	59.62
	5700	0.3287	0.3417	0.0075	0.0032	59.10
	6500	0.3123	0.3282	0.0067	0.0029	58.57
5 step	2200	0.5018	0.4153	0.0120	0.0067	50.11
	2500	0.4765	0.4137	0.0135	0.0007	53.7
	2700	0.4578	0.4101	0.0135	0.0070	53.70
	3000	0.4338	0.4030	0.0138	0.0068	53.22
	3500	0.4073	0.3917	0.0155	0.0068	54.00
	4000	0.3818	0.3797	0.0157	0.0067	53.72
	5000	0.3447	0.3553	0.0137	0.0058	59.62
	5700	0.3287	0.3417	0.0125	0.0053	59.10
	6500	0.3123	0.3282	0.0112	0.0048	58.57

Note: Samsung maintains measurement tolerance of: $C_x, C_y = \pm 0.005$

e) Chromaticity Region & Coordinates

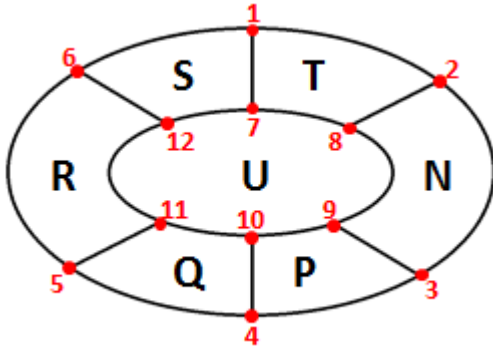

Region	2200K		2500K		2700K		3000K		3500K	
	CIE x	CIE y	CIE x	CIE y	CIE x	CIE y	CIE x	CIE y	CIE x	CIE y
1	0.4967	0.4196	0.4708	0.4179	0.4521	0.4142	0.4283	0.4071	0.4018	0.3957
2	0.5059	0.4254	0.4806	0.4252	0.4619	0.4216	0.4382	0.4146	0.4125	0.4046
3	0.5110	0.4211	0.4862	0.4211	0.4675	0.4175	0.4437	0.4105	0.418	0.4005
4	0.5069	0.4110	0.4821	0.4096	0.4634	0.4059	0.4393	0.3989	0.4128	0.3877
5	0.4977	0.4052	0.4724	0.4022	0.4537	0.3986	0.4293	0.3913	0.4022	0.3788
6	0.4926	0.4095	0.4667	0.4064	0.4481	0.4028	0.4239	0.3954	0.3966	0.3828
7	0.4987	0.4179	0.4731	0.4162	0.4544	0.4126	0.4305	0.4054	0.404	0.3941
8	0.5043	0.4214	0.4789	0.4206	0.4603	0.417	0.4364	0.41	0.4104	0.3994
9	0.5073	0.4188	0.4823	0.4181	0.4636	0.4145	0.4397	0.4075	0.4137	0.397
10	0.5049	0.4127	0.4798	0.4112	0.4612	0.4076	0.4371	0.4005	0.4106	0.3893
11	0.4993	0.4092	0.4740	0.4068	0.4553	0.4032	0.4311	0.396	0.4042	0.384
12	0.4963	0.4118	0.4706	0.4093	0.452	0.4057	0.4279	0.3984	0.4009	0.3864

Region	4000K		5000K		5700K		6500K	
	CIE x	CIE y	CIE x	CIE y	CIE x	CIE y	CIE x	CIE y
1	0.3764	0.3837	0.3397	0.3583	0.3242	0.3445	0.3082	0.3307
2	0.3871	0.3926	0.3482	0.367	0.332	0.3524	0.3153	0.3377
3	0.3925	0.3887	0.3532	0.364	0.3365	0.3496	0.3194	0.3352
4	0.3872	0.3758	0.3497	0.3524	0.3333	0.339	0.3164	0.3257
5	0.3765	0.3668	0.3412	0.3436	0.3254	0.331	0.3093	0.3187
6	0.3711	0.3707	0.3362	0.3465	0.3209	0.3338	0.3052	0.3212
7	0.3786	0.3821	0.3417	0.3571	0.326	0.3434	0.3098	0.3297
8	0.385	0.3874	0.3468	0.3623	0.3307	0.3481	0.3141	0.3339
9	0.3882	0.3851	0.3498	0.3605	0.3334	0.3464	0.3166	0.3324
10	0.385	0.3773	0.3477	0.3535	0.3314	0.3401	0.3148	0.3267
11	0.3786	0.372	0.3426	0.3483	0.3267	0.3353	0.3105	0.3225
12	0.3754	0.3743	0.3396	0.35	0.324	0.3369	0.308	0.324

3. Typical Characteristics Graphs

a) Spectrum Distribution ($I_f = 65 \text{ mA}$, $T_s = 25 \text{ }^\circ\text{C}$)

CCT : 2700K (80 CRI)

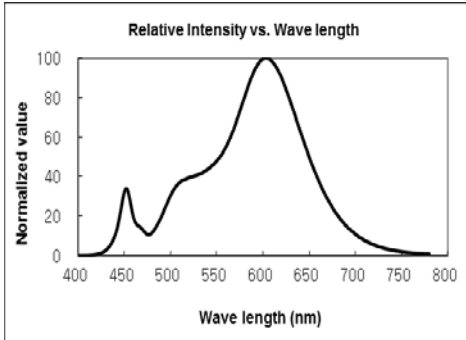

CCT : 3000K (80 CRI)

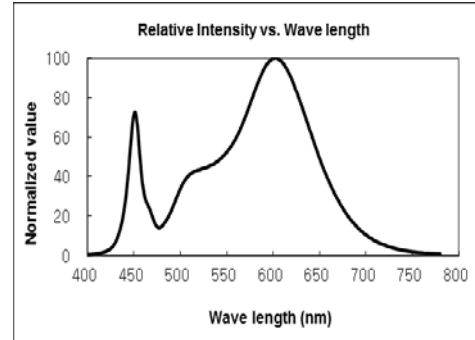

CCT : 3500K (80 CRI)

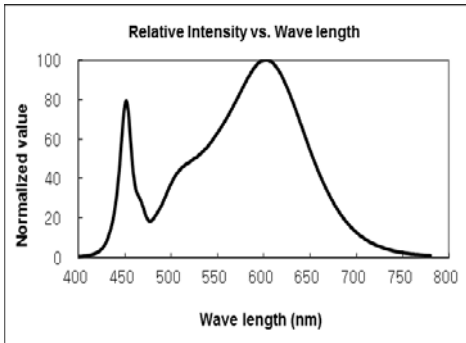

CCT : 4000K (80 CRI)

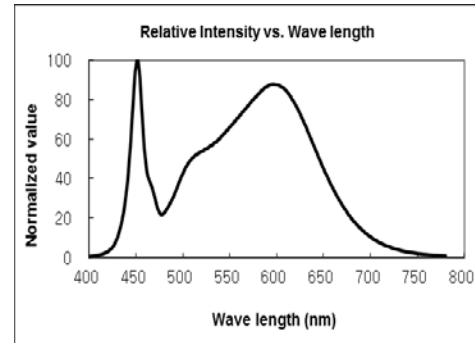

CCT : 5000K (80 CRI)

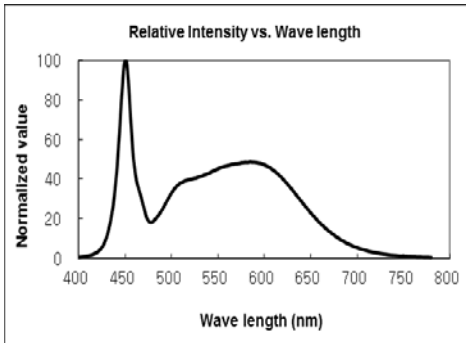

CCT : 5700K (80 CRI)

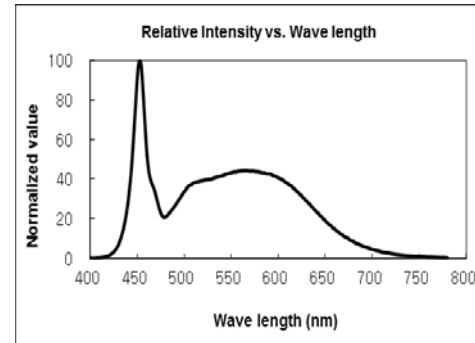

CCT : 6500K (80 CRI)

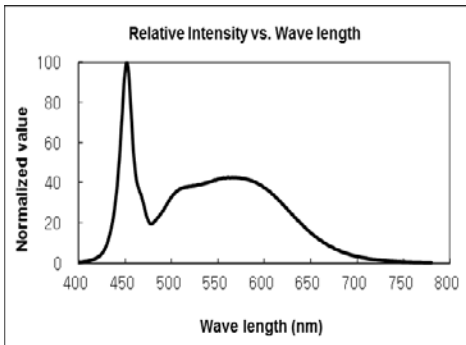

b) Forward Current Characteristics ($T_s = 25\text{ }^\circ\text{C}$)

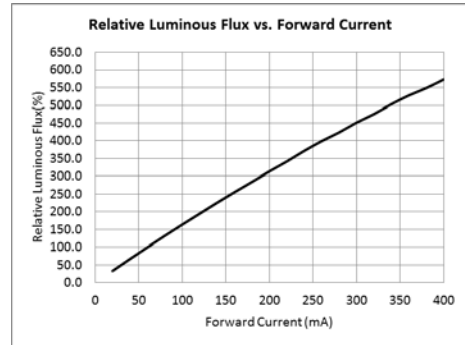

c) Temperature Characteristics ($I_F = 65\text{ mA}$)

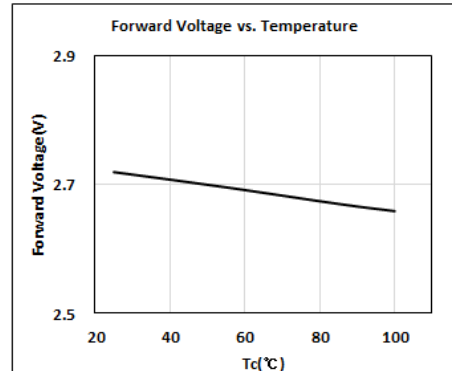

d) Color Shift Characteristics ($T_s = 25\text{ }^\circ\text{C}$, $I_F = 65\text{ mA}$)

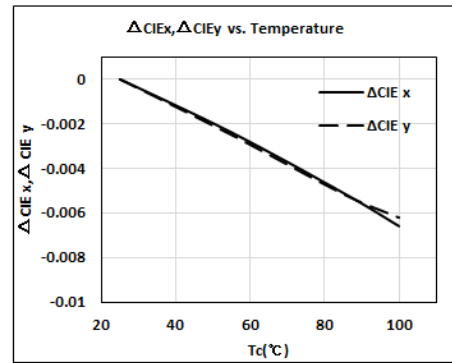
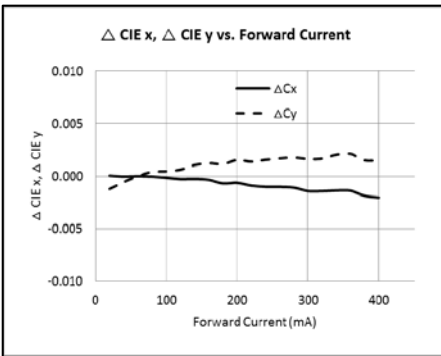

e) Derating Curve

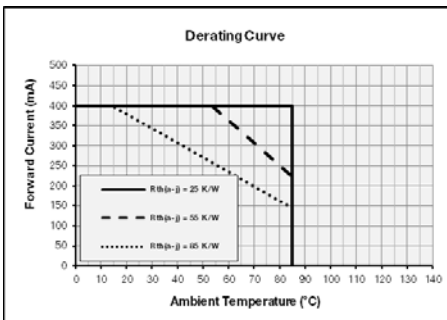

f) Beam Angle Characteristics ($I_F = 65\text{ mA}$, $T_s = 25\text{ }^\circ\text{C}$)

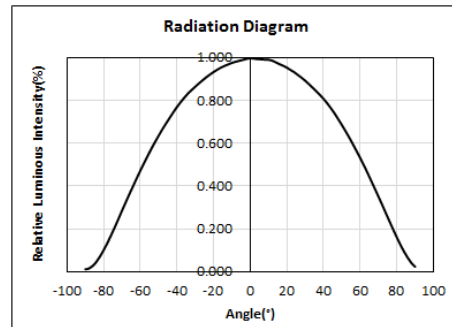

4. Outline Drawing & Dimension

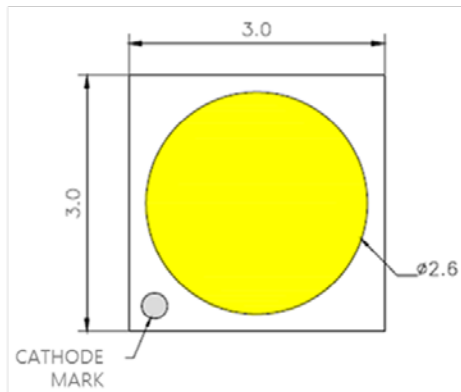

[TOP VIEW]

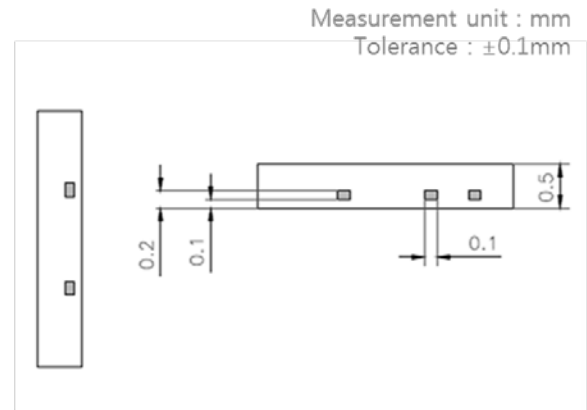

[SIDE VIEW]

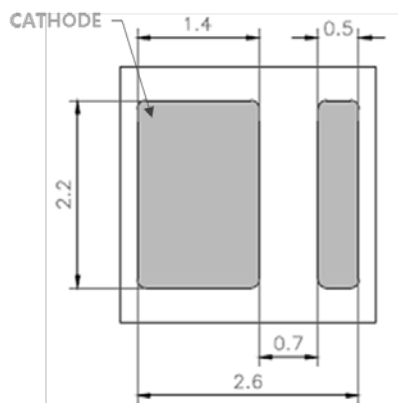

[BOTTOM VIEW]

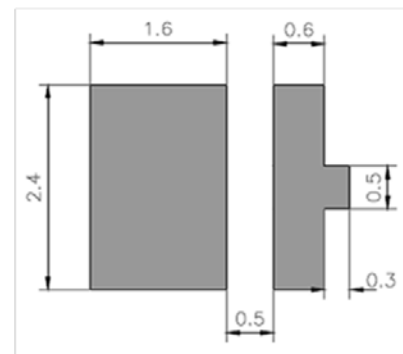

[RECOMMENDED PCB SOLDER PAD]

Notes:

- 1) This LED has built-in ESD protection device(s) connected in parallel to LED chip(s).
- 2) T_s point and measurement method:
 - ① Measure one point at the cathode pad, if necessary remove PSR of PCB to reach T_s point.
 - ② All pads must be soldered to the PCB to dissipate heat properly, otherwise the LED can be damaged.

Precautions:

- 1) Pressure on the LEDs will influence to the reliability of the LEDs. Precautions should be taken to avoid strong pressure on the LEDs. Do not put stress on the LEDs during heating.
- 2) Re-soldering should not be done after the LEDs have been soldered. If re-soldering is unavoidable, LED's characteristics should be carefully checked before and after such repair.

- 3) Do not stack assembled PCBs together. Since materials of LEDs is soft, abrasion between two PCB assembled with LED might cause catastrophic failure of the LEDs.

5. Reliability Test Items & Conditions

a) Test Items

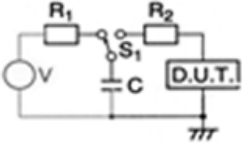
Test Item	Test Condition	Test Hour / Cycle	Sample No.
Room Temperature Life Test	25 °C, DC 400 mA	1000 h	22
High Temperature Life Test	85 °C, DC 400 mA	1000 h	22
High Temperature Humidity Life Test	60 °C, 90 % RH, DC 400 mA	1000 h	22
Low Temperature Life Test	-40 °C, DC 400 mA	1000 h	22
Powered Temperature Cycle Test	-45 °C / 20 min ↔ 85 °C / 20 min, sweep 100 min cycle on/off: each 5 min, DC 150 mA	100 cycles	22
Thermal Cycle	-40 °C / 15 min ↔ 100 °C / 15 min → Hot plate 180 °C	500 cycles	100
High Temperature Storage	120 °C	1000 h	11
Low Temperature Storage	-40 °C	1000 h	11
ESD (HBM)		5 times	30
ESD (MM)			
Vibration Test	20~2000~20 Hz, 200 m/s ² , sweep 4 min X, Y, Z 3 direction, each 1 cycle	4 cycles	11
Mechanical Shock Test	1500 g, 0.5 ms 3 shocks each X-Y-Z axis	5 cycles	11

b) Criteria for Judging the Damage

Item	Symbol	Test Condition (T _s = 25 °C)	Limit	
			Min	Max
Forward Voltage	V _F	I _F = 65 mA	Init. Value * 0.9	Init. Value * 1.1
Luminous Flux	Φ _v	I _F = 65 mA	Init. Value * 0.7	Init. Value * 1.1

6. Soldering Conditions

a) Reflow Conditions (Pb free)

Reflow frequency: 2 times max.



b) Manual Soldering Conditions

Not more than 5 seconds @ max. 300 °C, under soldering iron.

7. Tape & Reel

a) Taping Dimension

(unit: mm)

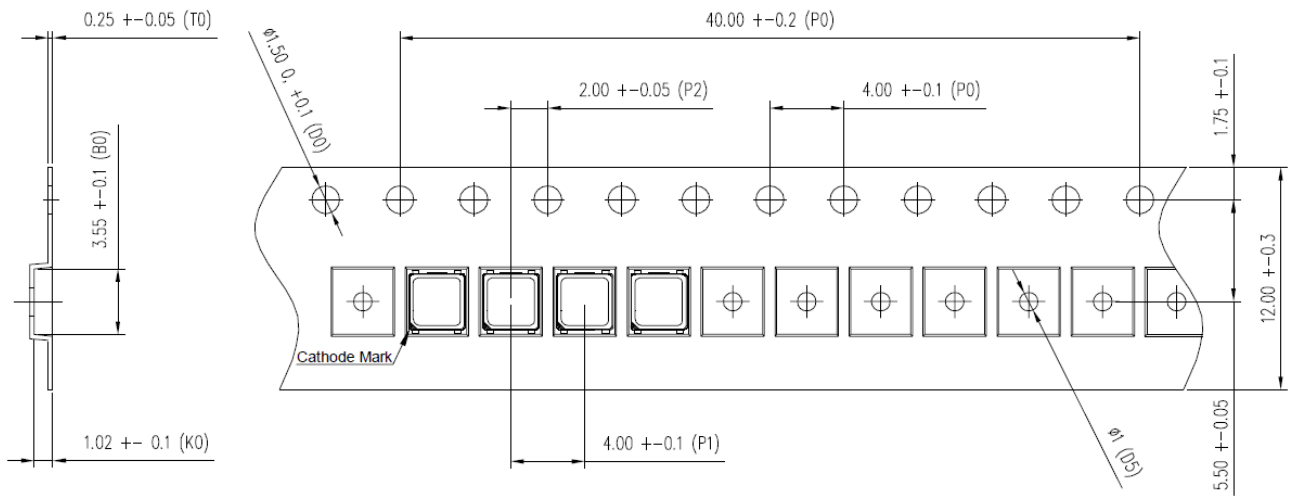

Taping Direction

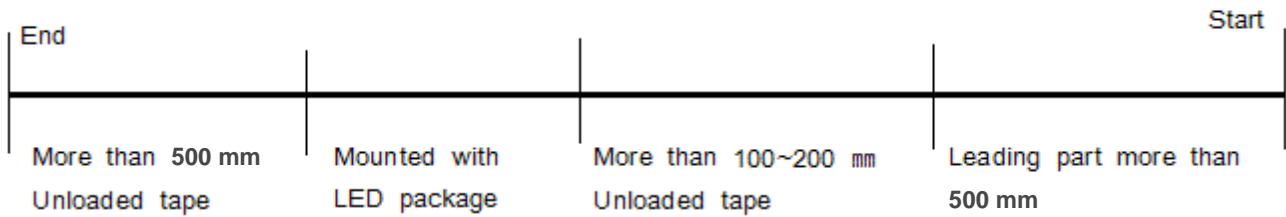
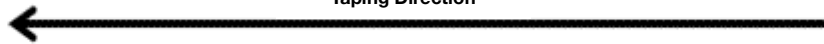

b) Reel Dimension

(unit: mm)

**Notes:**

- 1) Quantity: The quantity/reel is 5,000 pcs
- 2) Cumulative Tolerance: Cumulative tolerance / 10 pitches is ± 0.2 mm
- 3) Adhesion Strength of Cover Tape: Adhesion strength is 0.1-0.7 N when the cover tape is turned off from the carrier tape at 10° angle to the carrier tape
- 4) Packaging: P/N, Manufacturing data code no. and quantity are indicated on the aluminum packing bag

8. Label Structure

a) Label Structure

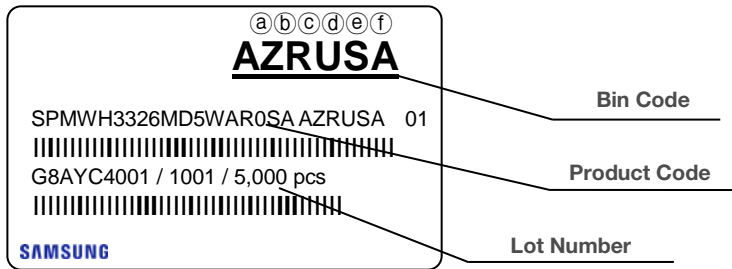

Note: Denoted bin code and product code above is only an example (see description on page 5)

Bin Code:

- ⒶⒷ: Forward Voltage bin (refer to page 8)
- ⒸⒹ: Chromaticity bin (refer to page 10-13)
- ⒺⒻ: Luminous Flux bin (refer to page 8)

b) Lot Number

The lot number is composed of the following characters:

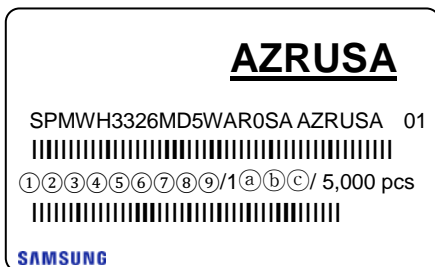

① ②③④⑤⑥⑦⑧⑨ / 1ⒶⒷⒸ / 5,000 pcs

- ① : Production site (S: Giheung, Korea, G: Tianjin, China)
- ② : 8 (LED)
- ③ : Product state (A: Normal, B: Bulk, C: First Production, R: Reproduction, S: Sample)
- ④ : Year (Z: 2015, A: 2016, B: 2017...)
- ⑤ : Month (1~9, A, B, C)
- ⑥⑦⑧⑨ : Day (1~9, A, B~V)
- ⒶⒷⒸ : Product serial number (001 ~ 999)

9. Packing Structure

a) Packing Process (The quantity of PKG on the Reel to be Max 5,000pcs)

Reel

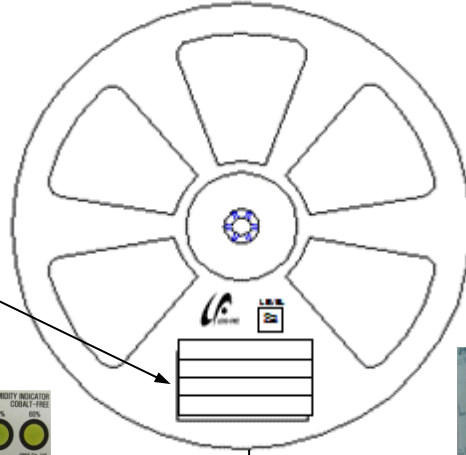
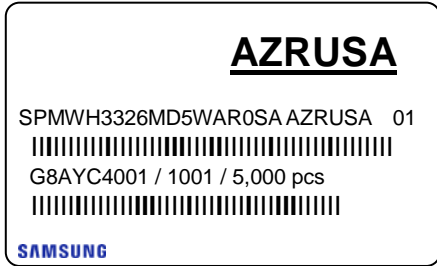

Aluminum Vinyl Packing Bag

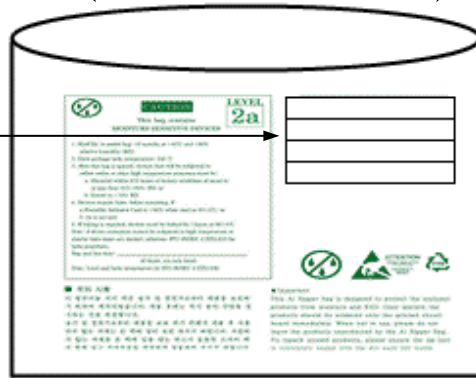
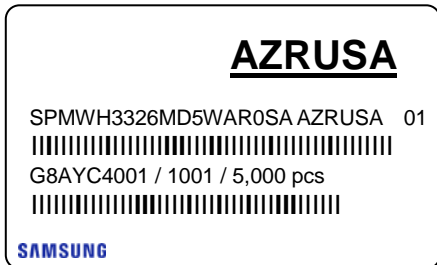

Outer Box

Material: Paper (SW3B(B))

Type	Size (mm)			Note
	L	W	H	
7 inch L	245 ± 5	220 ± 5	182 ± 5	Up to 10 reels
7 inch S	245 ± 5	220 ± 5	86 ± 5	Up to 5 reels

① Side Label

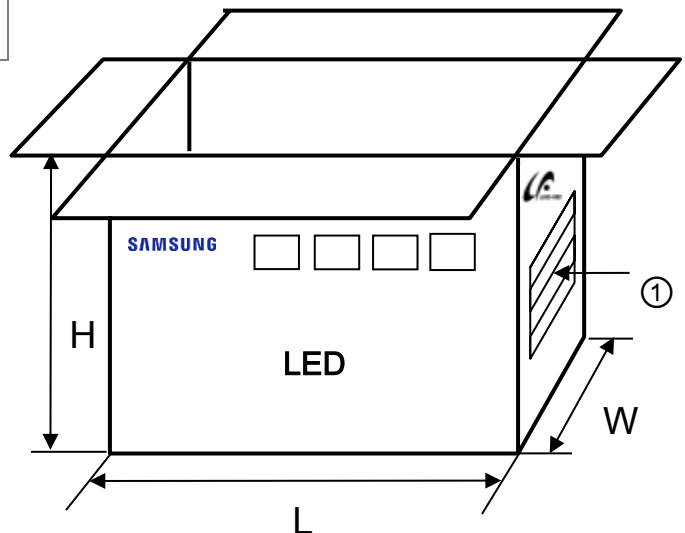
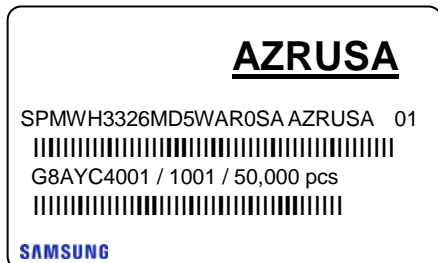

b) Packing Process for kitting (The quantity of PKG on the Reel to be Max 5,000pcs)

Reel

Kitting 'A'

AY★YSA

SPMWH3326MD5WA★YSA AY★YSA 01
 G8AW94001 / 1001 / 5,000 pcs

SAMSUNG

Kitting 'B'

AY★YSA

SPMWH3326MD5WA★YSA AY★YSA 01
 G8AW94001 / 1001 / 5,000 pcs

SAMSUNG

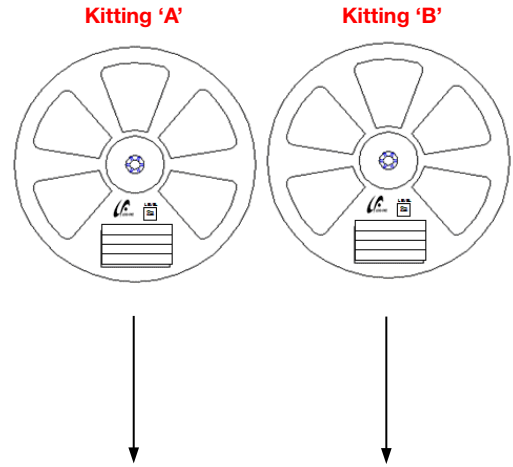

Aluminum Vinyl Packing Bag

Kitting 'A'

AY★YSA

SPMWH3326MD5WA★YSA AY★YSA 01
 G8AW94001 / 1001 / 5,000 pcs

SAMSUNG

Kitting 'B'

AY★YSA

SPMWH3326MD5WA★YSA AY★YSA 01
 G8AW94001 / 1001 / 5,000 pcs

SAMSUNG



Outer Box

Kitting 'A'

AY★YSA

SPMWH3326MD5WA★YSA AY★YSA 01
 G8AW94001 / 1001 / 50,000 pcs

SAMSUNG [BOX Label]

Kitting 'B'

AY★YSA

SPMWH3326MD5WA★YSA AY★YSA 01
 G8AW94001 / 1001 / 50,000 pcs

SAMSUNG [BOX Label]

Note: "★" can be Nominal CCT code.

Material: Paper (SW3B(B))

Type	Size (mm)			Note
	L	W	H	
7 inch L	245 ± 5	220 ± 5	182 ± 5	Up to 10 reels



10. Precautions in Handling & Use

- 1) For over-current-proof function, customers are recommended to apply resistors to prevent sudden change of the current caused by slight shift of the voltage.
- 2) This device should not be used in any type of fluid such as water, oil, organic solvent, etc. When washing is required, IPA is recommended to use.
- 3) When the LEDs illuminate, operating current should be decided after considering the ambient maximum temperature.
- 4) LEDs must be stored in a clean environment. If the LEDs are to be stored for three months or more after being shipped from Samsung, they should be packed by a sealed container with nitrogen gas injected (shelf life of sealed bags: 12 months, temperature $\sim 40\text{ }^{\circ}\text{C}$, $\sim 90\text{ \% RH}$).
- 5) After storage bag is opened, device subjected to soldering, solder reflow, or other high temperature processes must be:
 - a. Mounted within 672 hours (28 days) at an assembly line with a condition of no more than $30\text{ }^{\circ}\text{C}$ / 60 \% RH , or
 - b. Stored at $<10\text{ \% RH}$
- 6) Repack unused products with anti-moisture packing, fold to close any opening and then store in a dry place.
- 7) Devices require baking before mounting, if humidity card reading is $>60\text{ \%}$ at $23 \pm 5\text{ }^{\circ}\text{C}$.
- 8) Devices must be baked for 10~24 hours at $60 \pm 5\text{ }^{\circ}\text{C}$, if baking is required.
- 9) The LEDs are sensitive to the static electricity and surge. It is recommended to use a wrist band or anti-electrostatic glove when handling the LEDs. If voltage exceeding the absolute maximum rating is applied to LEDs, it may cause damage or even destruction to LED devices. Damaged LEDs may show some unusual characteristics such as increase in leak current, lowered turn-on voltage, or abnormal lighting of LEDs at low current.
- 10) VOCs (Volatile Organic Compounds) can be generated from adhesives, flux, hardener or organic additives used in luminaires (fixtures). Transparent LED silicone encapsulant is permeable to those chemicals and they may lead a discoloration of encapsulant when they exposed to heat or light. This phenomenon can cause a significant loss of light emitted (output) from the luminaires (fixtures). In order to prevent these problems, we recommend users to know the physical properties of the materials used in luminaires, and they must be selected carefully.
- 11) Risk of sulfurization (or tarnishing)

The LED from Samsung Electronics Co., Ltd. uses a silver-plated lead frame and its surface color may change to black (or dark colored) when it is exposed to sulfur (S), chlorine (Cl) or other halogen compound. Sulfurization of lead frame may cause intensity degradation, change of chromaticity coordinates and, in extreme cases, open circuit. It requires caution. Due to possible sulfurization of lead frame, LED should not be used and stored together with oxidizing substances made of materials such as: rubber, plain paper, lead solder cream, etc.

Legal and additional information.

[About Samsung Electronics Co., Ltd.](#)

Samsung inspires the world and shapes the future with transformative ideas and technologies.

The company is redefining the worlds of TVs, smartphones, wearable devices, tablets, digital appliances, network systems, and memory, system LSI, foundry and LED solutions. For the latest news, please visit the Samsung Newsroom at news.samsung.com.

Copyright © 2018 Samsung Electronics Co., Ltd. All rights reserved.

Samsung is a registered trademark of Samsung Electronics Co., Ltd.

Specifications and designs are subject to change without notice. Non-metric weights and measurements are approximate. All data were deemed correct at time of creation. Samsung is not liable for errors or omissions. All brand, product, service names and logos are trademarks and/or registered trademarks of their respective owners and are hereby recognized and acknowledged.

Samsung Electronics Co., Ltd.

95, Samsung 2-ro

Giheung-gu

Yongin-si, Gyeonggi-do, 446-711

KOREA

www.samsungled.com

SAMSUNG

Looking for pricing, stock, or lifecycle information?

Click below to explore more details on WIN SOURCE:

- ⊖ [View SPMWH3326MD5WAPYSA on WIN SOURCE](#)
- ⊖ [Samsung Information](#)

Optimize Your Supply Chain with WIN SOURCE Solutions

- ✓ Global Sourcing Solution
- ✓ Obsolete Management
- ✓ Cost Control Management
- ✓ Shortage Management
- ✓ Alternative Solution
- ✓ Excess Inventory Management