



**THE DATASHEET OF
SPMWHT327FD5GBUMS4**



Middle Power LED Series 3030

LM302A



LM302A leads lighting design trend with high performance and efficacy

Features & Benefits

- 1 W class middle-high power LED
- EMC resin for high reliability
- Standard form factor for design flexibility
- High performance and efficacy



Table of Contents

1.	Characteristics	-----	3
2.	Product Code Information	-----	13
3.	Typical Characteristics Graphs	-----	15
4.	Outline Drawing & Dimension	-----	18
5.	Reliability Test Items & Conditions	-----	20
6.	Soldering Conditions	-----	21
7.	Tape & Reel	-----	22
8.	Label Structure	-----	24
9.	Packing Structure	-----	25
10.	Precautions in Handling & Use	-----	27

1. Characteristics

a) Absolute Maximum Rating

Item	Symbol	Rating	Unit	Condition
Operating Temperature	T_a	-40 ~ +85	°C	-
Storage Temperature	T_{stg}	-40 ~ +100	°C	-
LED Junction Temperature	T_j	125	°C	-
Forward Current	I_F	200	mA	-
Peak Pulsed Forward Current	I_{FP}	400	mA	Duty 1/10, pulse width 10 ms
Assembly Process Temperature	-	260 <10	°C s	-
ESD (HBM)	-	5	kV	-

b) Electro-optical Characteristics ($I_F = 150 \text{ mA}$, $T_s = 25 \text{ }^\circ\text{C}$)

Item	Nominal CCT (K)	Rank	Bin	Min.	Typ.	Max.	Unit
Forward Voltage (V_f)		GB	BZ	5.8	-	6.0	V
			B1	6.0	-	6.2	
			B2	6.2	-	6.4	
			B3	6.4	-	6.6	
			B4	6.6	-	6.8	
Luminous Flux (Φ_v)	2700	S0	S2	102	-	110	lm
			S3	110	-	118	
			S4	118	-	126	
	3000	S0	S2	104	-	112	
			S3	112	-	120	
			S4	120	-	128	
	3500	S0	S2	107	-	115	
			S3	115	-	123	
			S4	123	-	131	
	4000	S0	S2	109	-	117	
			S3	117	-	125	
			S4	125	-	133	
5000	S0	S2	113	-	121		
		S3	121	-	129		
		S4	129	-	137		
5700	S0	S2	111	-	119		
		S3	119	-	127		
		S4	127	-	135		
6500	S0	S2	109	-	117		
		S3	117	-	125		
		S4	125	-	133		
Reverse Voltage (@ 5 mA)				0.7	-	1.2	V
Color Rendering Index (R_a)		5		80	-	-	-
Special CRI (R9)				0	-	-	-
Thermal Resistance (junction to solder point)				-	12	-	$^\circ\text{C/W}$
Beam Angle				-	120	-	$^\circ$

Note:

Samsung maintains measurement tolerance of: forward voltage = $\pm 0.1 \text{ V}$, luminous flux = $\pm 5 \%$, CRI = ± 3 , R9 = ± 6.5

2. Product Code Information

1	2	3	4	5	6	7	8	9	10	11	12	13	14	15	16	17	18
S	P	M	W	H	T	3	2	7	F	D	5	G	B	W	0	S	0

Digit	PKG Information	Code	Specification
1 2 3	Samsung Package Middle Power	SPM	
4 5	Color	WH	White
6	Product Version	T	
7 8 9	Form Factor	327	3.0 x 3.0 x 0.65 mm; 2 pads; LM302
10	Sorting Current	F	150 mA
11	Chromaticity Coordinates	D	ANSI Standard
12	CRI	5	Min. 80
13 14	Forward Voltage (V)	G B	5.8-6.8 Bin Code: BZ 5.8-6.0 B1 6.0-6.2 B2 6.2-6.4 B3 6.4-6.6 B4 6.6-6.8
15 16	CCT (K)	W★ V★ U★ T★ R★ Q★ P★	2700 W1, W2, W3, W4, W5, W6, W7, W8, W9, WA, WB, WC, WD, WE, WF, WG 3000 V1, V2, V3, V4, V5, V6, V7, V8, V9, VA, VB, VC, VD, VE, VF, VG 3500 U1, U2, U3, U4, U5, U6, U7, U8, U9, UA, UB, UC, UD, UE, UF, UG 4000 T1, T2, T3, T4, T5, T6, T7, T8, T9, TA, TB, TC, TD, TE, TF, TG 5000 R1, R2, R3, R4, R5, R6, R7, R8, R9, RA 5700 Q1, Q2, Q3, Q4, Q5, Q6, Q7, Q8, Q9, QA 6500 P1, P2, P3, P4, P5, P6, P7, P8, P9, PA ★ : "C" (Whole bin) or "M" (Quarter bin)
17 18	Luminous Flux (lm)	S 0	Bin Code: S2, S3, S4

a) Luminous Flux Bins ($I_F = 150 \text{ mA}$, $T_s = 25 \text{ °C}$)

Nominal CCT (K)	CRI Min.	Product Code	Flux Bin	Flux Range (Φ_v , lm)
2700	80	SPMWHT327FD5GBW☆S0	S2	102 ~ 110
			S3	110 ~ 118
			S4	118 ~ 126
		SPMWHT327FD5GBW☆S2	S2	102 ~ 110
			S3	110 ~ 118
			S4	118 ~ 126
3000	80	SPMWHT327FD5GBV☆S0	S2	104 ~ 112
			S3	112 ~ 120
			S4	120 ~ 128
		SPMWHT327FD5GBV☆S2	S2	104 ~ 112
			S3	112 ~ 120
			S4	120 ~ 128
3500	80	SPMWHT327FD5GBU☆S0	S2	107 ~ 115
			S3	115 ~ 123
			S4	123 ~ 131
		SPMWHT327FD5GBU☆S2	S2	107 ~ 115
			S3	115 ~ 123
			S4	123 ~ 131
4000	80	SPMWHT327FD5GBT☆S0	S2	109 ~ 117
			S3	117 ~ 125
			S4	125 ~ 133
		SPMWHT327FD5GBT☆S2	S2	109 ~ 117
			S3	117 ~ 125
			S4	125 ~ 133

Note:

"☆" can be "0" (Whole bin) or "M" (Quarter bin) of the color binning

a) Luminous Flux Bins ($I_F = 150 \text{ mA}$, $T_s = 25 \text{ }^\circ\text{C}$)

Nominal CCT (K)	CRI Min.	Product Code	Flux Bin	Flux Range (Φ_v , lm)
5000	80	SPMWHT327FD5GBR☆S0	S2	113 ~ 121
			S3	121 ~ 129
			S4	129 ~ 137
		SPMWHT327FD5GBR☆S2	S2	113 ~ 121
			S3	121 ~ 129
			S4	129 ~ 137
5700	80	SPMWHT327FD5GBQ☆S0	S2	111 ~ 119
			S3	119 ~ 127
			S4	127 ~ 135
		SPMWHT327FD5GBQ☆S2	S2	111 ~ 119
			S3	119 ~ 127
			S4	127 ~ 135
6500	80	SPMWHT327FD5GBP☆S0	S2	109 ~ 117
			S3	117 ~ 125
			S4	125 ~ 133
		SPMWHT327FD5GBP☆S2	S2	109 ~ 117
			S3	117 ~ 125
			S4	125 ~ 133

Note:

"☆" can be "0" (Whole bin) or "M" (Quarter bin) of the color binning

b) Color Bins ($I_f = 150 \text{ mA}$, $T_s = 25 \text{ }^\circ\text{C}$)

Nominal CCT (K)	CRI Min.	Product Code	Color Rank	Chromaticity Bins
2700	80	SPMWHT327FD5GBW0S★	W0 (Whole bin)	W1, W2, W3, W4, W5, W6, W7, W8, W9, WA, WB, WC, WD, WE, WF, WG
		SPMWHT327FD5GBWMS★	WM (Quarter bin)	W6, W7, WA, WB
3000	80	SPMWHT327FD5GBV0S★	V0 (Whole bin)	V1, V2, V3, V4, V5, V6, V7, V8, V9, VA, VB, VC, VD, VE, VF, VG
		SPMWHT327FD5GBVMS★	VM (Quarter bin)	V6, V7, VA, VB
3500	80	SPMWHT327FD5GBU0S★	U0 (Whole bin)	U1, U2, U3, U4, U5, U6, U7, U8, U9, UA, UB, UC, UD, UE, UF, UG
		SPMWHT327FD5GBUMS★	UM (Quarter bin)	U6, U7, UA, UB
4000	80	SPMWHT327FD5GBT0S★	T0 (Whole bin)	T1, T2, T3, T4, T5, T6, T7, T8, T9, TA, TB, TC, TD, TE, TF, TG
		SPMWHT327FD5GBTMS★	TM (Quarter bin)	T6, T7, TA, TB
5000	80	SPMWHT327FD5GBR0S★	R0 (Whole bin)	R1, R2, R3, R4, R5 R6, R7, R8, R9, RA
		SPMWHT327FD5GBRMS★	RM (Quarter bin)	R1, R2, R3, R4, R5, R6
5700	80	SPMWHT327FD5GBQ0S★	Q0 (Whole bin)	Q1, Q2, Q3, Q4, Q5 Q6, Q7, Q8, Q9, QA
		SPMWHT327FD5GBQMS★	QM (Quarter bin)	Q1, Q2, Q3, Q4, Q5, Q6
6500	80	SPMWHT327FD5GBP0S★	P0 (Whole bin)	P1, P2, P3, P4, P5 P6, P7, P8, P9, PA
		SPMWHT327FD5GBPMS★	PM (Quarter bin)	P1, P2, P3, P4, P5, P6

Note:

"★" can be "0", "2", "3" or "4" of the luminous flux binning

c) Voltage Bins ($I_f = 150 \text{ mA}$, $T_s = 25 \text{ }^\circ\text{C}$)

Nominal CCT (K)	CRI Min.	Product Code	Voltage Rank	Voltage Bin	Voltage Range (V)
-	-	-	GB	BZ	5.8 ~ 6.0
				B1	6.0 ~ 6.2
				B2	6.2 ~ 6.4
				B3	6.4 ~ 6.6
				B4	6.6 ~ 6.8

c) Chromaticity Region & Coordinates ($I_F = 150 \text{ mA}$, $T_s = 25^\circ \text{C}$)

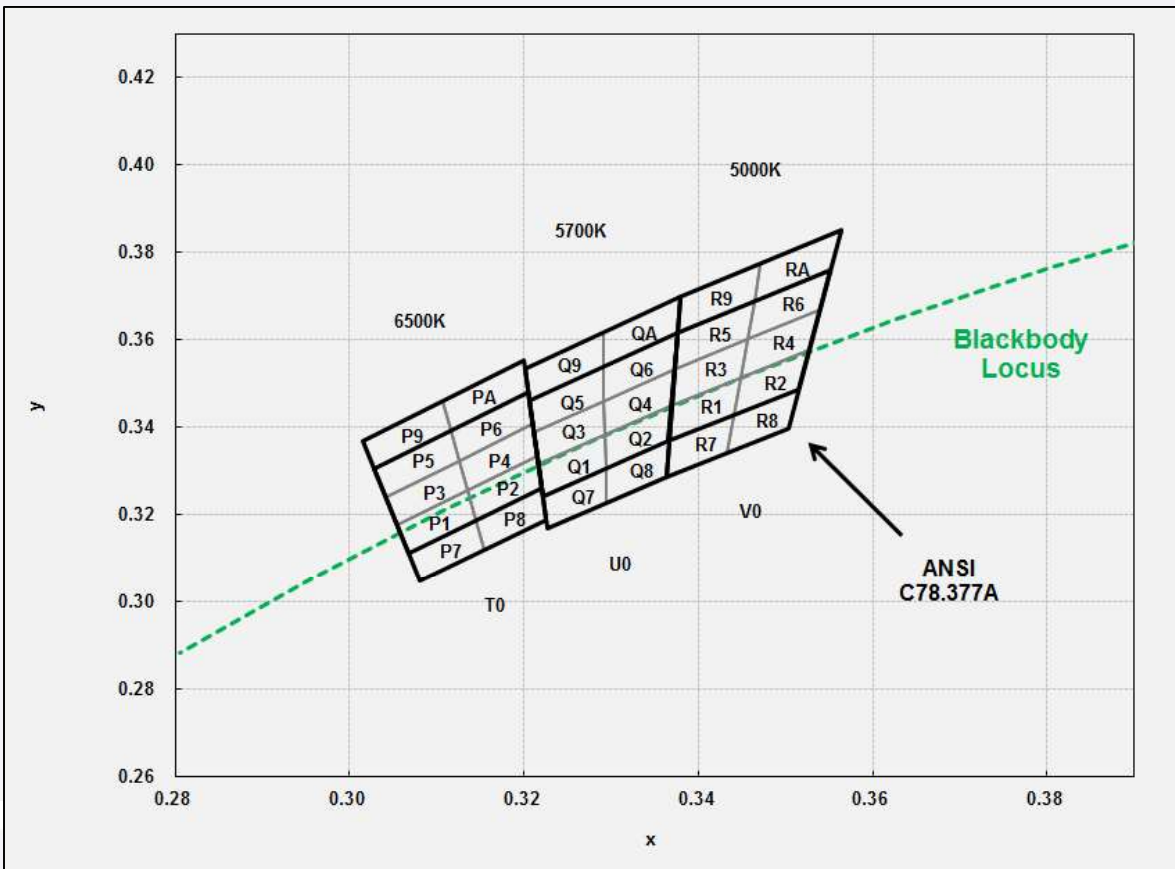
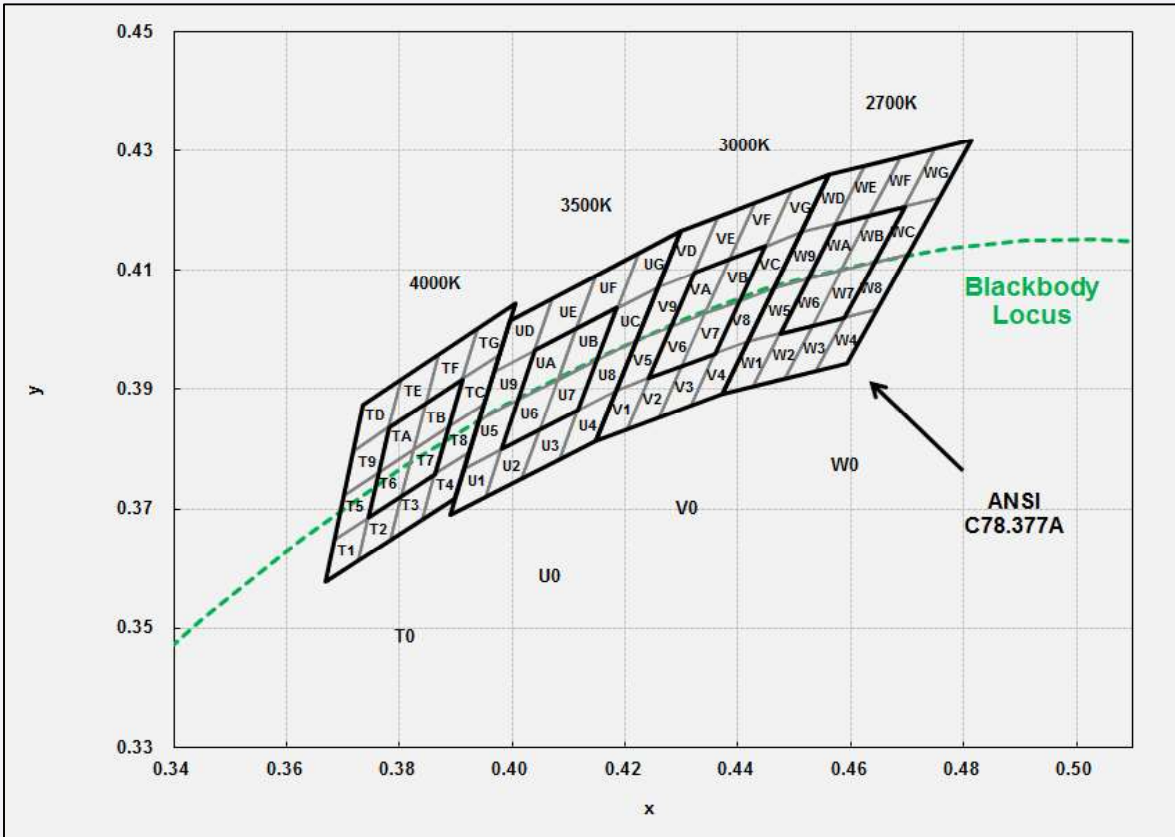

c) Chromaticity Region & Coordinates (I_F = 150 mA, T_s = 25 °C)

Region	CIE x	CIE y	Region	CIE x	CIE y
W rank (2700 K)					
W1	0.4373	0.3893	W9	0.4465	0.4071
	0.4418	0.3981		0.4513	0.4164
	0.4475	0.3994		0.4573	0.4178
	0.4428	0.3906		0.4523	0.4085
W2	0.4428	0.3906	WA	0.4523	0.4085
	0.4475	0.3994		0.4573	0.4178
	0.4532	0.4008		0.4634	0.4193
	0.4483	0.3919		0.4582	0.4099
W3	0.4483	0.3919	WB	0.4582	0.4099
	0.4532	0.4008		0.4634	0.4193
	0.4589	0.4021		0.4695	0.4207
	0.4538	0.3931		0.4641	0.4112
W4	0.4538	0.3931	WC	0.4641	0.4112
	0.4589	0.4021		0.4695	0.4207
	0.4646	0.4034		0.4756	0.4221
	0.4593	0.3944		0.4700	0.4126
W5	0.4418	0.3981	WD	0.4513	0.4164
	0.4465	0.4071		0.4562	0.4260
	0.4523	0.4085		0.4624	0.4274
	0.4475	0.3994		0.4573	0.4178
W6	0.4475	0.3994	WE	0.4573	0.4178
	0.4523	0.4085		0.4624	0.4274
	0.4582	0.4099		0.4687	0.4289
	0.4532	0.4008		0.4634	0.4193
W7	0.4532	0.4008	WF	0.4634	0.4193
	0.4582	0.4099		0.4687	0.4289
	0.4641	0.4112		0.4750	0.4304
	0.4589	0.4021		0.4695	0.4207
W8	0.4589	0.4021	WG	0.4695	0.4207
	0.4641	0.4112		0.4750	0.4304
	0.4700	0.4126		0.4813	0.4319
	0.4646	0.4034		0.4756	0.4221

Region	CIE x	CIE y	Region	CIE x	CIE y
V rank (3000 K)					
V1	0.4147	0.3814	V9	0.4221	0.3984
	0.4183	0.3898		0.4259	0.4073
	0.4242	0.3919		0.4322	0.4096
	0.4203	0.3833		0.4281	0.4006
V2	0.4203	0.3833	VA	0.4281	0.4006
	0.4242	0.3919		0.4322	0.4096
	0.4300	0.3939		0.4385	0.4119
	0.4259	0.3853		0.4342	0.4028
V3	0.4259	0.3853	VB	0.4342	0.4028
	0.4300	0.3939		0.4385	0.4119
	0.4359	0.3960		0.4449	0.4141
	0.4316	0.3873		0.4403	0.4049
V4	0.4316	0.3873	VC	0.4403	0.4049
	0.4359	0.3960		0.4449	0.4141
	0.4418	0.3981		0.4513	0.4164
	0.4373	0.3893		0.4465	0.4071
V5	0.4183	0.3898	VD	0.4259	0.4073
	0.4221	0.3984		0.4299	0.4165
	0.4281	0.4006		0.4364	0.4188
	0.4242	0.3919		0.4322	0.4096
V6	0.4242	0.3919	VE	0.4322	0.4096
	0.4281	0.4006		0.4364	0.4188
	0.4342	0.4028		0.4430	0.4212
	0.4300	0.3939		0.4385	0.4119
V7	0.4300	0.3939	VF	0.4385	0.4119
	0.4342	0.4028		0.4430	0.4212
	0.4403	0.4049		0.4496	0.4236
	0.4359	0.3960		0.4449	0.4141
V8	0.4359	0.3960	VG	0.4449	0.4141
	0.4403	0.4049		0.4496	0.4236
	0.4465	0.4071		0.4562	0.4260
	0.4418	0.3981		0.4513	0.4164

c) Chromaticity Region & Coordinates

Region	CIE x	CIE y	Region	CIE x	CIE y
U rank (3500 K)					
U1	0.3889	0.3690	U9	0.3941	0.3848
	0.3915	0.3768		0.3968	0.3930
	0.3981	0.3800		0.4040	0.3966
	0.3953	0.3720		0.4010	0.3882
U2	0.3953	0.3720	UA	0.4010	0.3882
	0.3981	0.3800		0.4040	0.3966
	0.4048	0.3832		0.4113	0.4001
	0.4017	0.3751		0.4080	0.3916
U3	0.4017	0.3751	UB	0.4080	0.3916
	0.4048	0.3832		0.4113	0.4001
	0.4116	0.3865		0.4186	0.4037
	0.4082	0.3782		0.4150	0.3950
U4	0.4082	0.3782	UC	0.4150	0.3950
	0.4116	0.3865		0.4186	0.4037
	0.4183	0.3898		0.4259	0.4073
	0.4147	0.3814		0.4221	0.3984
U5	0.3915	0.3768	UD	0.3968	0.3930
	0.3941	0.3848		0.3996	0.4015
	0.4010	0.3882		0.4071	0.4052
	0.3981	0.3800		0.4040	0.3966
U6	0.3981	0.3800	UE	0.4040	0.3966
	0.4010	0.3882		0.4071	0.4052
	0.4080	0.3916		0.4146	0.4089
	0.4048	0.3832		0.4113	0.4001
U7	0.4048	0.3832	UF	0.4113	0.4001
	0.4080	0.3916		0.4146	0.4089
	0.4150	0.3950		0.4222	0.4127
	0.4116	0.3865		0.4186	0.4037
U8	0.4116	0.3865	UG	0.4186	0.4037
	0.4150	0.3950		0.4222	0.4127
	0.4221	0.3984		0.4299	0.4165
	0.4183	0.3898		0.4259	0.4073

Region	CIE x	CIE y	Region	CIE x	CIE y
T rank (4000 K)					
T1	0.3670	0.3578	T9	0.3702	0.3722
	0.3726	0.3612		0.3763	0.3760
	0.3744	0.3685		0.3782	0.3837
	0.3686	0.3649		0.3719	0.3797
T2	0.3726	0.3612	TA	0.3763	0.3760
	0.3783	0.3646		0.3825	0.3798
	0.3804	0.3721		0.3847	0.3877
	0.3744	0.3685		0.3782	0.3837
T3	0.3783	0.3646	TB	0.3825	0.3798
	0.3840	0.3681		0.3887	0.3836
	0.3863	0.3758		0.3912	0.3917
	0.3804	0.3721		0.3847	0.3877
T4	0.3840	0.3681	TC	0.3887	0.3837
	0.3898	0.3716		0.3950	0.3875
	0.3924	0.3794		0.3978	0.3958
	0.3863	0.3758		0.3912	0.3917
T5	0.3686	0.3649	TD	0.3719	0.3797
	0.3744	0.3685		0.3782	0.3837
	0.3763	0.3760		0.3802	0.3916
	0.3702	0.3722		0.3736	0.3874
T6	0.3744	0.3685	TE	0.3782	0.3837
	0.3804	0.3721		0.3847	0.3877
	0.3825	0.3798		0.3869	0.3958
	0.3763	0.376		0.3802	0.3916
T7	0.3804	0.3721	TF	0.3847	0.3877
	0.3863	0.3758		0.3912	0.3917
	0.3887	0.3836		0.3937	0.4001
	0.3825	0.3798		0.3869	0.3958
T8	0.3863	0.3758	TG	0.3912	0.3917
	0.3924	0.3794		0.3978	0.3958
	0.3950	0.3875		0.4006	0.4044
	0.3887	0.3836		0.3937	0.4001

c) Chromaticity Region & Coordinates

Region	CIE x	CIE y	Region	CIE x	CIE y
R rank (5000 K)					
R1	0.3366	0.3369	R6	0.3456	0.3601
	0.3441	0.3428		0.3539	0.3669
	0.3449	0.3515		0.3551	0.3760
	0.3369	0.3451		0.3464	0.3688
R2	0.3441	0.3428	R7	0.3363	0.3287
	0.3515	0.3487		0.3433	0.3341
	0.3527	0.3578		0.3441	0.3428
	0.3449	0.3515		0.3366	0.3369
R3	0.3369	0.3451	R8	0.3433	0.3341
	0.3449	0.3515		0.3503	0.3396
	0.3456	0.3601		0.3515	0.3487
	0.3373	0.3534		0.3441	0.3428
R4	0.3449	0.3515	R9	0.3376	0.3616
	0.3527	0.3578		0.3464	0.3688
	0.3539	0.3669		0.3471	0.3775
	0.3456	0.3601		0.3379	0.3698
R5	0.3373	0.3534	RA	0.3464	0.3688
	0.3456	0.3601		0.3551	0.3760
	0.3464	0.3688		0.3564	0.3851
	0.3376	0.3616		0.3471	0.3775

Region	CIE x	CIE y	Region	CIE x	CIE y
Q rank (5700 K)					
Q1	0.3222	0.3243	Q6	0.3292	0.3461
	0.3294	0.3306		0.3373	0.3534
	0.3293	0.3384		0.3376	0.3616
	0.3217	0.3316		0.3292	0.3539
Q2	0.3294	0.3306	Q7	0.3227	0.3170
	0.3366	0.3369		0.3295	0.3228
	0.3369	0.3451		0.3294	0.3306
	0.3293	0.3384		0.3222	0.3243
Q3	0.3217	0.3316	Q8	0.3295	0.3228
	0.3293	0.3384		0.3363	0.3287
	0.3292	0.3461		0.3366	0.3369
	0.3212	0.3389		0.3294	0.3306
Q4	0.3293	0.3384	Q9	0.3207	0.3462
	0.3369	0.3451		0.3292	0.3539
	0.3373	0.3534		0.3291	0.3617
	0.3292	0.3461		0.3202	0.3535
Q5	0.3212	0.3389	QA	0.3292	0.3539
	0.3292	0.3461		0.3376	0.3616
	0.3292	0.3539		0.3379	0.3698
	0.3207	0.3462		0.3291	0.3617

c) Chromaticity Region & Coordinates

Region	CIE x	CIE y	Region	CIE x	CIE y
P rank (6500 K)					
P1	0.3068	0.3113	P6	0.3126	0.3324
	0.3145	0.3187		0.3210	0.3408
	0.3135	0.3256		0.3205	0.3481
	0.3055	0.3177		0.3117	0.3393
P2	0.3145	0.3187	P7	0.3081	0.3049
	0.3221	0.3261		0.3154	0.3119
	0.3216	0.3334		0.3145	0.3187
	0.3135	0.3256		0.3068	0.3113
P3	0.3055	0.3177	P8	0.3154	0.3119
	0.3135	0.3256		0.3226	0.3188
	0.3126	0.3324		0.3221	0.3261
	0.3041	0.3240		0.3145	0.3187
P4	0.3135	0.3256	P9	0.3028	0.3304
	0.3216	0.3334		0.3117	0.3393
	0.3210	0.3408		0.3107	0.3461
	0.3126	0.3324		0.3015	0.3368
P5	0.3041	0.3240	PA	0.3117	0.3393
	0.3126	0.3324		0.3205	0.3481
	0.3117	0.3393		0.3200	0.3554
	0.3028	0.3304		0.3107	0.3461

Note:

Samsung maintains measurement tolerance of: Cx, Cy = ± 0.005

3. Typical Characteristics Graphs

a) Spectrum Distribution ($I_f = 150 \text{ mA}$, $T_s = 25^\circ \text{C}$)

CCT: 2700 K



CCT: 3000 K

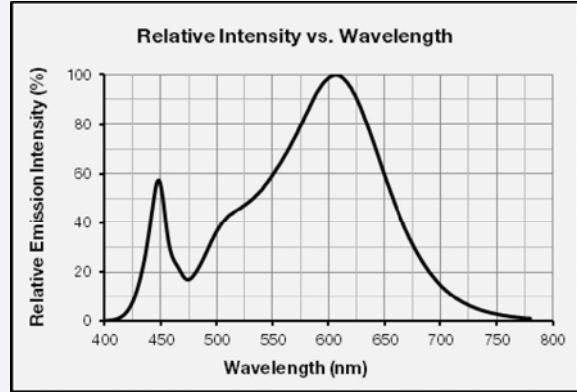

CCT: 3500 K

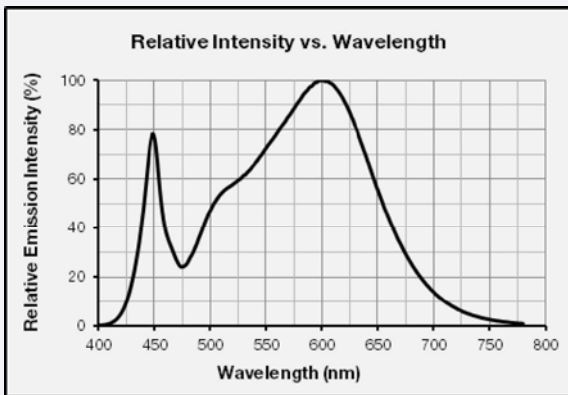

CCT: 4000 K

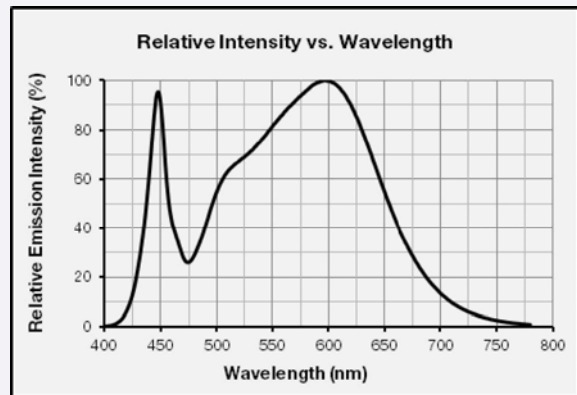

CCT: 5000 K

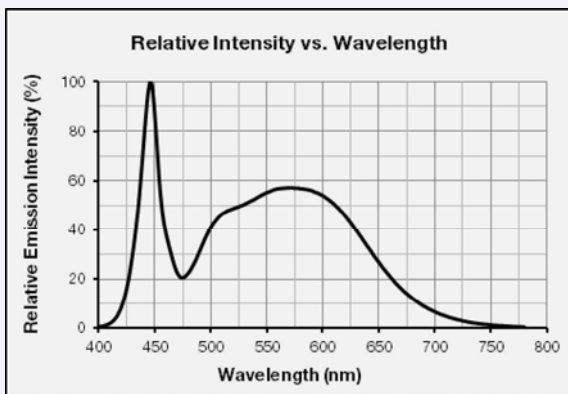

CCT: 5700 K

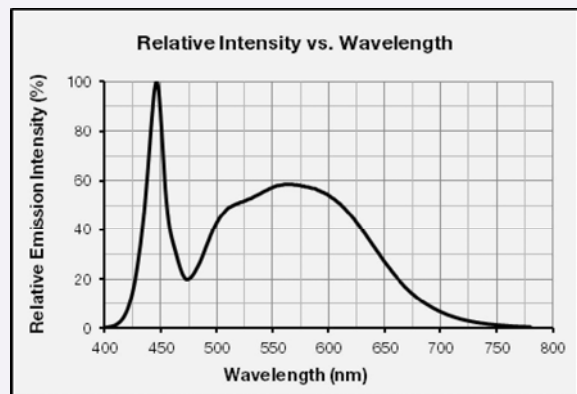

CCT: 6500 K

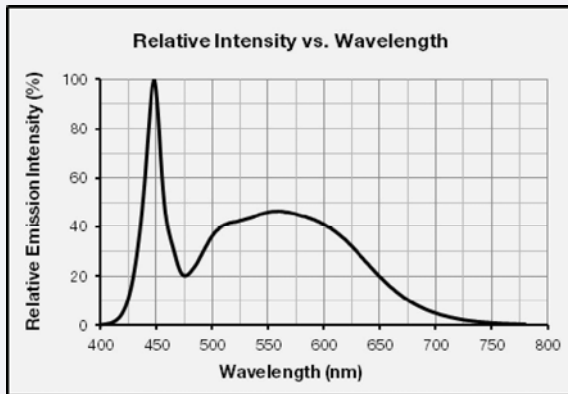

b) Forward Current Characteristics ($T_s = 25^\circ\text{C}$)

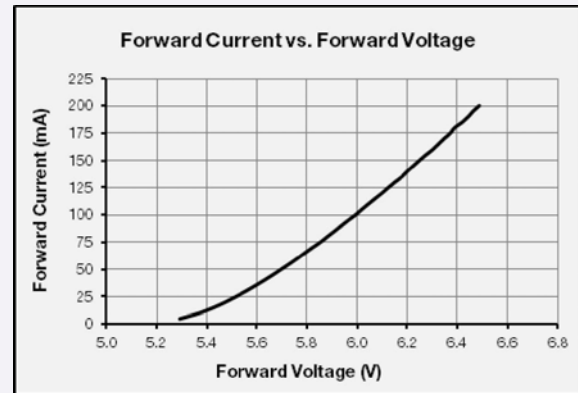
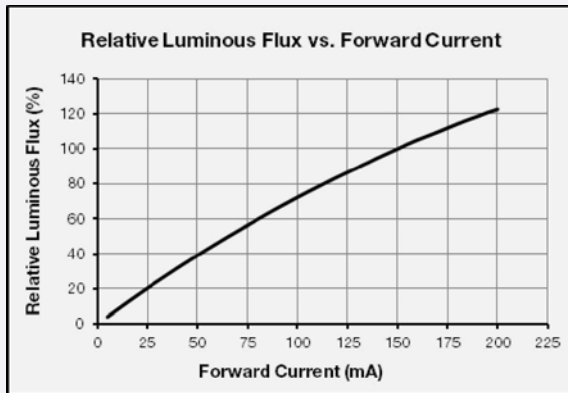

c) Temperature Characteristics ($I_f = 150\text{ mA}$)

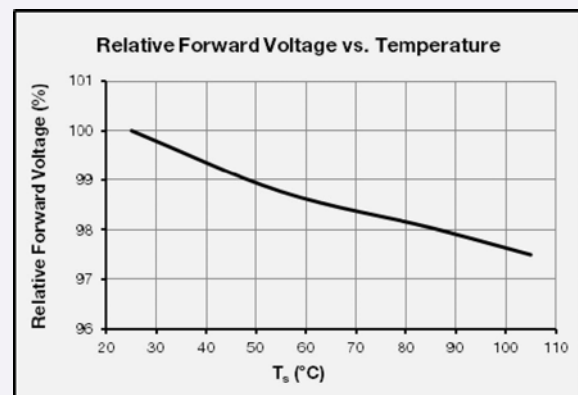
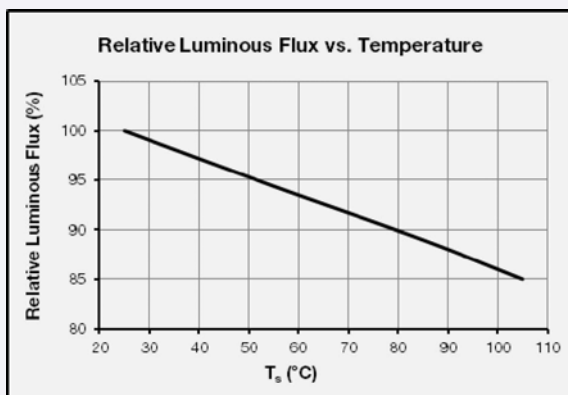

d) Color Shift Characteristics

$T_s = 25\text{ }^\circ\text{C}$

$I_f = 150\text{ mA}$

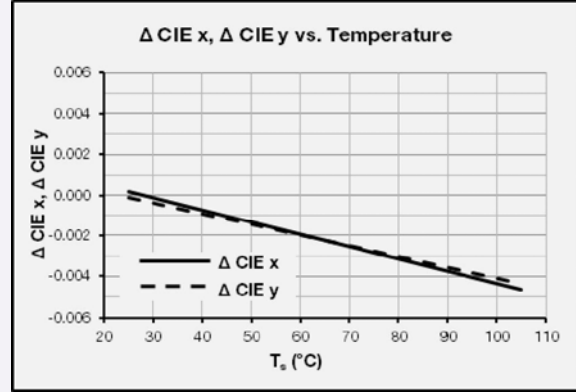
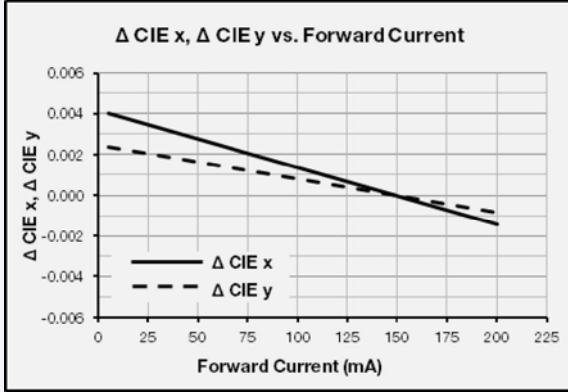

e) Derating Curve



f) Beam Angle Characteristics ($I_f = 150\text{ mA}$, $T_s = 25\text{ }^\circ\text{C}$)

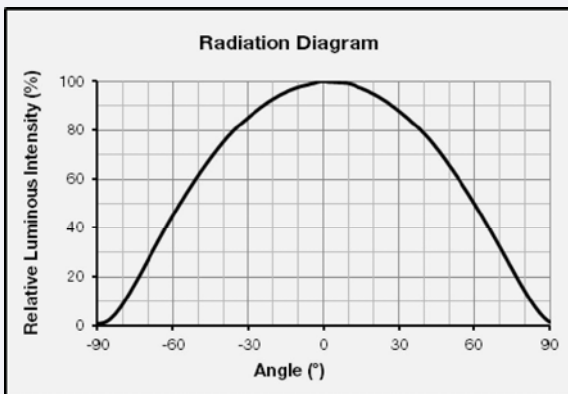

4. Outline Drawing & Dimension



1. Measurement unit: mm
2. Tolerance: ± 0.10 mm
3. Do not place pressure on the encapsulation resin ①



Recommended Land Pattern

Notes:

- 1) This LED has built-in ESD protection device(s) connected in parallel to LED chip(s).
- 2) T_s point and measurement method:
 - ① Measure one point at the cathode pad. If necessary, remove PSR of PCB to reach T_s point.
 - ② All pads must be soldered to the PCB to dissipate heat properly, otherwise the LED can be damaged.

Precautions:

- 1) Pressure on the LEDs will influence to the reliability of the LEDs. Precautions should be taken to avoid strong pressure on the LEDs. Do not put stress on the LEDs during heating.
- 2) Re-soldering should not be done after the LEDs have been soldered. If re-soldering is unavoidable, LED's characteristics should be carefully checked before and after such repair.
- 3) Do not stack assembled PCBs together. Since materials of LEDs is soft, abrasion between two PCB assembled with LED might cause catastrophic failure of the LEDs.

5. Reliability Test Items and Conditions

a) Test Items

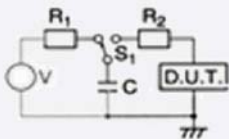
Test Item	Test Condition	Test Hour / Cycle		Sample Size
Room Temperature Life Test	25 °C, DC 200 mA	1000 h		22
High Temperature Life Test	85 °C, DC 200 mA	1000 h		22
High Temperature Humidity Life Test	85 °C, 85 % RH, DC 200 mA	1000 h		22
Low Temperature Life Test	-40 °C, DC 200 mA	1000 h		22
Powered Temperature Cycle Test	-45 °C / 20 min ↔ 85 °C / 20 min, sweep 100 min cycle on/off: each 5 min, DC 200 mA	100 cycles		22
Thermal Cycle	-45 °C / 15 min ↔ 125 °C / 15 min → Hot plate 180 °C	500 cycles		100
High Temperature Storage	120 °C	1000 h		11
Low Temperature Storage	-40 °C	1000 h		11
ESD (HBM)		R ₁ : 10 MΩ R ₂ : 1.5 kΩ C: 100 pF V: ±5 kV	5 times	30
ESD (MM)		R ₁ : 10 MΩ R ₂ : 0 C: 200 pF V: ±0.5 kV	5 times	30
Vibration Test	20~2000~20 Hz, 200 m/s ² , sweep 4 min X, Y, Z 3 direction, each 1 cycle	4 cycles		11
Mechanical Shock Test	1500 g, 0.5 ms 3 shocks each X-Y-Z axis	5 cycles		11

b) Criteria for Judging the Damage

Item	Symbol	Test Condition (T _s = 25 °C)	Limit	
			Min.	Max.
Forward Voltage	V _F	I _F = 150 mA	Init. Value * 0.9	Init. Value * 1.1
Luminous Flux	Φ _v	I _F = 150 mA	Init. Value * 0.7	Init. Value * 1.1

6. Soldering Conditions

a) Reflow Conditions (Pb free)

Reflow frequency: 2 times max.

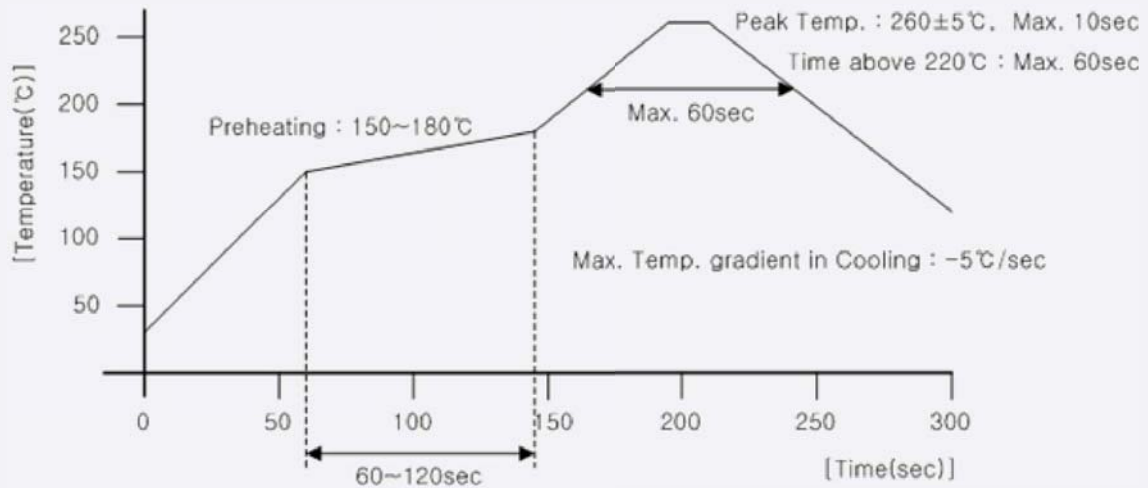

b) Manual Soldering Conditions

Not more than 5 seconds @ max. 300 °C, under soldering iron.

7. Tape & Reel

a) Taping Dimension

(unit: mm)



b) Reel Dimension

**Notes:**

- 1) Quantity: The quantity/reel is 4,000 pcs
- 2) Cumulative tolerance: Cumulative tolerance / 10 pitches is ± 0.2 mm
- 3) Adhesion strength of cover tape: Adhesion strength is 0.1-0.7 N when the cover tape is turned off from the carrier tape at 10° angle to the carrier tape
- 4) Packaging: P/N, Manufacturing data code no. and quantity are indicated on the aluminum packing bag

8. Label Structure

a) Label Structure



Note: Denoted bin code and product code above is only an example
'★' means all kind of Chromaticity Coordinate Ranks

Bin Code:

- ⒶⒷ: Forward Voltage bin (refer to page 7)
- ⒸⒹ: Chromaticity bin (refer to page 9~12)
- ⒺⒻ: Luminous Flux bin (refer to page 4-5)

b) Lot Number



The lot number is composed of the following characters:

①②③④⑤⑥⑦⑧⑨ / 1ⒶⒷⒸ / 4,000 pcs

- ① : Production site (S: Giheung, Korea, G: Tianjin, China)
- ② : L (LED)
- ③ : Product state (A: Normal, B: Bulk, C: First Production, R: Reproduction, S: Sample)
- ④ : Year (Z: 2015, A: 2016, B: 2017 ...)
- ⑤ : Month (1~9, A, B, C)
- ⑥ : Day (1~9, A, B~V)
- ⑦⑧⑨ : Product serial number (001 ~ 999)
- ⒶⒷⒸ : Reel number (001 ~ 999)

9. Packing Structure

a) Packing Process

Reel



Aluminum Vinyl Packing Bag



Outer Box

Material: Paper (SW3B(B))

Type	Size (mm)			Note
	L	W	H	
7 inch L	245 ± 5	220 ± 5	182 ± 5	Up to 10 reels
7 inch S	245 ± 5	220 ± 5	86 ± 5	Up to 5 reels

① Side Label

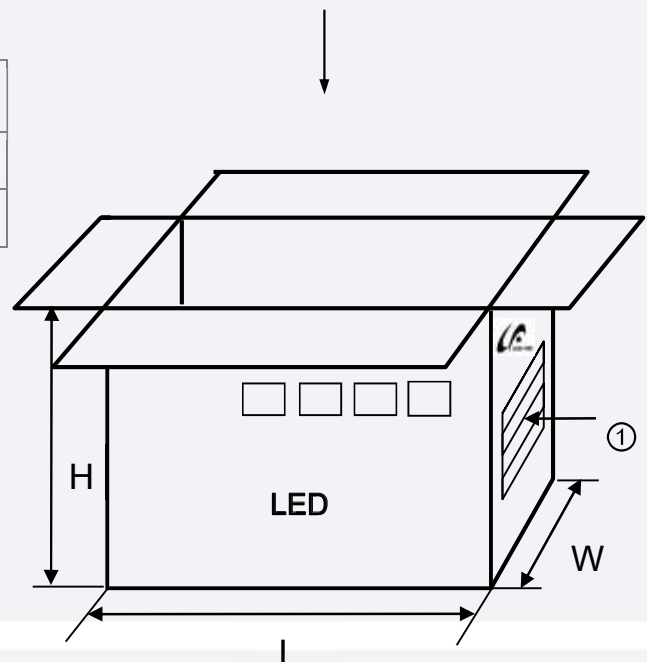
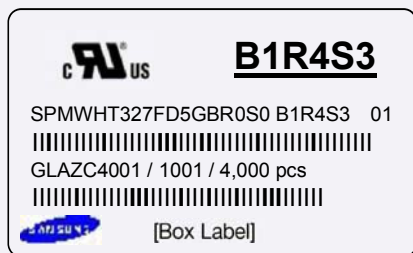

c) Aluminum Vinyl Packing Bag



CAUTION

This bag contains
MOISTURE SENSITIVE DEVICES

LEVEL
2a

1. Shelf life in sealed bag: 12 months at < 40°C and < 90% relative humidity (RH)
2. Peak package body temperature: 240 °C
3. After this bag is opened, devices that will be subjected to reflow solder or other high temperature processes must be:
 - a. Mounted within 672 hours at factory conditions of equal to or less than 30°C / 60% RH, or
 - b. Stored at < 10% RH
4. Devices require bake, before mounting, if:
 - a. Humidity Indicator Card is > 60% when read at 23±5°C, or
 - b. 2a is not met.
5. If baking is required, devices must be baked for 10 ~ 24 hours at 60±5°C

Note: If device containers cannot be subjected to high temperature or shorter bake times are desired, reference IPC/JEDEC J-STD-033 for bake procedure.

Bag seal due date: _____
(If blank, see code label)

Note: Level and body temperature by IPC/JEDEC J-STD-020



B1R4S3

SPMWHT327FD5GBR0S0 B1R4S3 01
 |||
 GLAZC4001 / 1001 / 4,000 pcs
 |||



LEAD-FREE





ATTENTION
OBSERVE PRECAUTIONS
FOR HANDLING
ELECTROSTATIC SENSITIVE
DEVICES



OTHER

주의 사항

이 알루미늄 지퍼 백은 습기 및 정전기로부터 제품을 보호하기 위하여 제작되었습니다. 개봉 후에는 즉시 솔더 작업을 실시하는 것을 권장합니다.

습기 및 정전기로부터 제품을 보호 하기 위해서 개봉 후 사용하지 않는 자재는 본 팩에 넣어 보관 하시기 바랍니다. 사용하지 않는 자재를 본 팩에 넣을 때는 반드시 동봉된 드라이 팩과 함께 넣고 지퍼부분을 완전하게 밀봉하여 주시기 바랍니다.

Important

This Al Zipper bag is designed to protect the enclosed products from moisture and ESD. Once opened, the products should be soldered onto the printed circuit board immediately. When not in use, please do not leave the products unprotected by the Al Zipper Bag. To repack unused products., please ensure the zip-lock is completely sealed with the dry pack left inside.

c) Silica Gel & Humidity Indicator Card inside Aluminum Vinyl Bag



10. Precautions in Handling & Use

- 1) For over-current-proof function, customers are recommended to apply resistors to prevent sudden change of the current caused by slight shift of the voltage.
- 2) This device should not be used in any type of fluid such as water, oil, organic solvent, etc. When washing is required, IPA is recommended to use.
- 3) When the LEDs illuminate, operating current should be decided after considering the ambient maximum temperature.
- 4) LEDs must be stored in a clean environment. If the LEDs are to be stored for three months or more after being shipped from Samsung, they should be packed by a sealed container with nitrogen gas injected (shelf life of sealed bags: 12 months, temperature $\sim 40^{\circ}\text{C}$, $\sim 90\%$ RH).
- 5) After storage bag is opened, device subjected to soldering, solder reflow, or other high temperature processes must be:
 - a. Mounted within 672 hours (28 days) at an assembly line with a condition of no more than 30°C / 60% RH, or
 - b. Stored at $<10\%$ RH
- 6) Repack unused products with anti-moisture packing, fold to close any opening and then store in a dry place.
- 7) Devices require baking before mounting, if humidity card reading is $>60\%$ at $23 \pm 5^{\circ}\text{C}$.
- 8) Devices must be baked for 10~24 hours at $60 \pm 5^{\circ}\text{C}$, if baking is required.
- 9) The LEDs are sensitive to the static electricity and surge. It is recommended to use a wrist band or anti-electrostatic glove when handling the LEDs. If voltage exceeding the absolute maximum rating is applied to LEDs, it may cause damage or even destruction to LED devices. Damaged LEDs may show some unusual characteristics such as increase in leak current, lowered turn-on voltage, or abnormal lighting of LEDs at low current.
- 10) VOCs (Volatile Organic Compounds) can be generated from adhesives, flux, hardener or organic additives used in luminaires (fixtures). Transparent LED silicone encapsulant is permeable to those chemicals and they may lead a discoloration of encapsulant when they exposed to heat or light. This phenomenon can cause a significant loss of light emitted (output) from the luminaires (fixtures). In order to prevent these problems, we recommend users to know the physical properties of the materials used in luminaires, and they must be selected carefully.
- 11) Risk of sulfurization (or tarnishing)

The LED from Samsung Electronics Co., Ltd. uses a silver-plated lead frame and its surface color may change to black (or dark colored) when it is exposed to sulfur (S), chlorine (Cl) or other halogen compound. Sulfurization of lead frame may cause intensity degradation, change of chromaticity coordinates and, in extreme cases, open circuit. It requires caution. Due to possible sulfurization of lead frame, LED should not be used and stored together with oxidizing substances made of materials such as: rubber, plain paper, lead solder cream, etc.

Legal and additional information.

About Samsung Electronics Co., Ltd.

Samsung Electronics Co., Ltd. is a global leader in technology, opening new possibilities for people everywhere. Through relentless innovation and discovery, we are transforming the worlds of TVs, smartphones, tablets, PCs, cameras, home appliances, printers, LTE systems, medical devices, semiconductors and LED solutions. We employ 286,000 people across 80 countries with annual sales of US\$216.7 billion. To discover more, please visit www.samsungled.com.

Copyright © 2015 Samsung Electronics Co., Ltd. All rights reserved.
Samsung is a registered trademark of Samsung Electronics Co., Ltd.
Specifications and designs are subject to change without notice. Non-metric weights and measurements are approximate. All data were deemed correct at time of creation. Samsung is not liable for errors or omissions. All brand, product, service names and logos are trademarks and/or registered trademarks of their respective owners and are hereby recognized and acknowledged.

Samsung Electronics Co., Ltd.
95, Samsung 2-ro
Giheung-gu
Yongin-si, Gyeonggi-do, 446-711
KOREA

www.samsungled.com



Looking for pricing, stock, or lifecycle information?

Click below to explore more details on WIN SOURCE:

 [View SPMWHT327FD5GBUMS4 on WIN SOURCE](#)

 [Samsung Information](#)

Optimize Your Supply Chain with WIN SOURCE Solutions

-  Global Sourcing Solution
-  Obsolete Management
-  Cost Control Management
-  Shortage Management
-  Alternative Solution
-  Excess Inventory Management