



**THE DATASHEET OF
SPMWHT327FD7GBT0S0**



Middle Power LED Series
3030

LM302A CRI 90

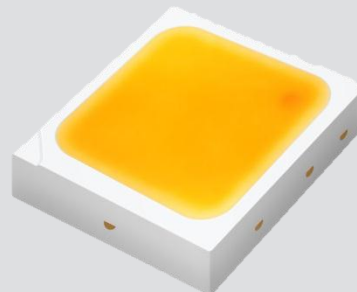

LM302A leads lighting design trend with high performance and efficacy

Features & Benefits

- 1 W class middle-high power LED
- EMC resin for high reliability
- Standard form factor for design flexibility
- High performance and efficacy



Table of Contents

| | | | |
|-----|-------------------------------------|-------|----|
| 1. | Characteristics | ----- | 3 |
| 2. | Product Code Information | ----- | 5 |
| 3. | Typical Characteristics Graphs | ----- | 14 |
| 4. | Outline Drawing & Dimension | ----- | 18 |
| 5. | Reliability Test Items & Conditions | ----- | 20 |
| 6. | Soldering Conditions | ----- | 21 |
| 7. | Tape & Reel | ----- | 22 |
| 8. | Label Structure | ----- | 24 |
| 9. | Packing Structure | ----- | 25 |
| 10. | Precautions in Handling & Use | ----- | 27 |

1. Characteristics

a) Absolute Maximum Rating

| Item | Symbol | Rating | Unit | Condition |
|------------------------------|-----------|------------|---------|-----------|
| Operating Temperature | T_a | -40 ~ +85 | °C | - |
| Storage Temperature | T_{stg} | -40 ~ +100 | °C | - |
| LED Junction Temperature | T_j | 125 | °C | - |
| Forward Current | I_F | 200 | mA | - |
| Assembly Process Temperature | - | 260 <10 | °C s | - |
| ESD (HBM) | - | 5 | kV | - |

b) Electro-optical Characteristics ($I_F = 150 \text{ mA}$, $T_s = 85 \text{ }^\circ\text{C}$)

| Item | Nominal CCT (K) | Rank | Bin | Min. | Typ. | Max. | Unit |
|---|-----------------|------|-----|------|------|-------|--------------------|
| Forward Voltage (V_f) | | YB | BY | 5.6 | - | 5.8 | V |
| | | | BZ | 5.8 | - | 6.0 | |
| | | | B1 | 6.0 | - | 6.2 | |
| | | | B2 | 6.2 | - | 6.4 | |
| | | | B3 | 6.4 | - | 6.6 | |
| Luminous Flux (Φ_v) | 2700 | S0 | S1 | 80.0 | - | 88.0 | lm |
| | | | S2 | 88.0 | - | 96.0 | |
| | 3000 | S0 | S1 | 85.0 | - | 93.0 | |
| | | | S2 | 93.0 | - | 101.0 | |
| | 3500 | S0 | S1 | 86.8 | - | 94.8 | |
| | | | S2 | 94.8 | - | 102.8 | |
| | 4000 | S0 | S1 | 88.6 | - | 96.6 | |
| | | | S2 | 96.6 | - | 104.6 | |
| | 5000 | S0 | S1 | 86.8 | - | 94.8 | |
| | | | S2 | 94.8 | - | 102.8 | |
| | 5700 | S0 | S1 | 85.0 | - | 93.0 | |
| | | | S2 | 93.0 | - | 101.0 | |
| | 6500 | S0 | S1 | 83.2 | - | 91.2 | |
| | | | S2 | 91.2 | - | 99.2 | |
| Reverse Voltage (@ 5 mA) | | | | 0.7 | - | 1.2 | V |
| Color Rendering Index (R_a) | | | | 90 | - | - | - |
| Special CRI (R9) | | | | 50 | - | - | - |
| Thermal Resistance (junction to solder point) | | | | - | 12 | - | $^\circ\text{C/W}$ |
| Beam Angle | | | | - | 120 | - | $^\circ$ |

Note:

Samsung maintains measurement tolerance of: forward voltage = $\pm 0.1 \text{ V}$, luminous flux = $\pm 5 \%$, CRI = ± 3 , R9 = ± 6.5

2. Product Code Information

| | | | | | | | | | | | | | | | | | |
|---|---|---|---|---|---|---|---|---|----|----|----|----|----|----|----|----|----|
| 1 | 2 | 3 | 4 | 5 | 6 | 7 | 8 | 9 | 10 | 11 | 12 | 13 | 14 | 15 | 16 | 17 | 18 |
| S | P | M | W | H | T | 3 | 2 | 7 | F | D | 7 | Y | B | W | 0 | S | 0 |

| Digit | PKG Information | Code | Specification |
|-------|------------------------------|---|--|
| 1 2 3 | Samsung Package Middle Power | SPM | |
| 4 5 | Color | WH | White |
| 6 | Product Version | T | |
| 7 8 9 | Form Factor | 327 | 3.0 x 3.0 x 0.65 mm; 2 pads; 2 chips |
| 10 | Sorting Current | F | 150 mA |
| 11 | Chromaticity Coordinates | D | ANSI Standard |
| 12 | CRI | 7 | Min. 90 |
| 13 14 | Forward Voltage (V) | YB | 5.6~6.6 Bin Code: BY 5.6~5.8 BZ 5.8~6.0 B1 6.0~6.2 B2 6.2~6.4 B3 6.4~6.6 |
| 15 16 | CCT (K) | W ☆ V ☆ U ☆ T ☆ R0 Q0 P0 | 2700 3000 3500 4000 5000 5700 6500 W1, W2, W3, W4, W5, W6, W7, W8, W9, WA, WB, WC, WD, WE, WF, WG V1, V2, V3, V4, V5, V6, V7, V8, V9, VA, VB, VC, VD, VE, VF, VG U1, U2, U3, U4, U5, U6, U7, U8, U9, UA, UB, UC, UD, UE, UF, UG T1, T2, T3, T4, T5, T6, T7, T8, T9, TA, TB, TC, TD, TE, TF, TG R1, R2, R3, R4, R7, R8 Q1, Q2, Q3, Q4, Q7, Q8 P1, P2, P3, P4, P7, P8 ☆ : "0" (Whole bin) or "M" (Quarter bin) |
| 17 18 | Luminous Flux (lm) | S0 | Bin Code: S1, S2 |

a) Luminous Flux Bins ($I_F = 150 \text{ mA}$, $T_s = 85 \text{ }^\circ\text{C}$)

| Nominal CCT (K) | CRI Min. | Product Code | Flux Bin | Flux Range (Φ_v , lm) |
|-----------------|----------|--------------------|----------|-----------------------------|
| 2700 | 90 | SPMWHT327FD7YBW☆S0 | S1 | 80.0 ~ 88.0 |
| | | | S2 | 88.0 ~ 96.0 |
| 3000 | 90 | SPMWHT327FD7YBV☆S0 | S1 | 85.0 ~ 93.0 |
| | | | S2 | 93.0 ~ 101.0 |
| 3500 | 90 | SPMWHT327FD7YBU☆S0 | S1 | 86.8 ~ 94.8 |
| | | | S2 | 94.8 ~ 102.8 |
| 4000 | 90 | SPMWHT327FD7YBT☆S0 | S1 | 88.6 ~ 96.6 |
| | | | S2 | 96.6 ~ 104.6 |
| 5000 | 90 | SPMWHT327FD7YBR0S0 | S1 | 86.8 ~ 94.8 |
| | | | S2 | 94.8 ~ 102.8 |
| 5700 | 90 | SPMWHT327FD7YBQ0S0 | S1 | 85.0 ~ 93.0 |
| | | | S2 | 93.0 ~ 101.0 |
| 6500 | 90 | SPMWHT327FD7YBP0S0 | S1 | 83.2 ~ 91.2 |
| | | | S2 | 91.2 ~ 99.2 |

Note:

"☆" can be "0" (Whole bin) or "M" (Quarter bin) of the color binning

b) Color Bins ($I_F = 150 \text{ mA}$, $T_s = 85 \text{ }^\circ\text{C}$)

| Nominal CCT (K) | CRI Min. | Product Code | Color Rank | Chromaticity Bins |
|-----------------|----------|--------------------|---------------------|---|
| 2700 | 90 | SPMWHT327FD7YBW0S0 | W0 (Whole bin) | W1, W2, W3, W4, W5, W6, W7, W8, W9, WA, WB, WC, WD, WE, WF, WG |
| | | SPMWHT327FD7YBWMS0 | WM (Quarter bin) | W6, W7, WA, WB |
| 3000 | 90 | SPMWHT327FD7YBV0S0 | V0 (Whole bin) | V1, V2, V3, V4, V5, V6, V7, V8, V9, VA, VB, VC, VD, VE, VF, VG |
| | | SPMWHT327FD7YBVMS0 | VM (Quarter bin) | V6, V7, VA, VB |
| 3500 | 90 | SPMWHT327FD7YBU0S0 | U0 (Whole bin) | U1, U2, U3, U4, U5, U6, U7, U8, U9, UA, UB, UC, UD, UE, UF, UG |
| | | SPMWHT327FD7YBUMS0 | UM (Quarter bin) | U6, U7, UA, UB |
| 4000 | 90 | SPMWHT327FD7YBT0S0 | T0 (Whole bin) | T1, T2, T3, T4, T5, T6, T7, T8, T9, TA, TB, TC, TD, TE, TF, TG |
| | | SPMWHT327FD7YBTMS0 | TM (Quarter bin) | T6, T7, TA, TB |
| 5000 | 90 | SPMWHT327FD7YBR0S0 | R0 (Whole bin) | R1, R2, R3 R4, R7, R8 |
| 5700 | 90 | SPMWHT327FD7YBQ0S0 | Q0 (Whole bin) | Q1, Q2, Q3 Q4, Q7, Q8 |
| 6500 | 90 | SPMWHT327FD7YBP0S0 | P0 (Whole bin) | P1, P2, P3, P4, P7, P8 |

c) Voltage Bins ($I_f = 150 \text{ mA}$, $T_s = 85 \text{ °C}$)

| Nominal CCT (K) | CRI Min. | Product Code | Voltage Rank | Voltage Bin | Voltage Range (V) |
|-----------------|----------|--------------|--------------|-------------|-------------------|
| - | - | - | YB | BY | 5.6 ~ 5.8 |
| | | | | BZ | 5.8 ~ 6.0 |
| | | | | B1 | 6.0 ~ 6.2 |
| | | | | B2 | 6.2 ~ 6.4 |
| | | | | B3 | 6.4 ~ 6.6 |

d) Chromaticity Region & Coordinates ($I_f = 150 \text{ mA}$, $T_s = 85^\circ\text{C}$)

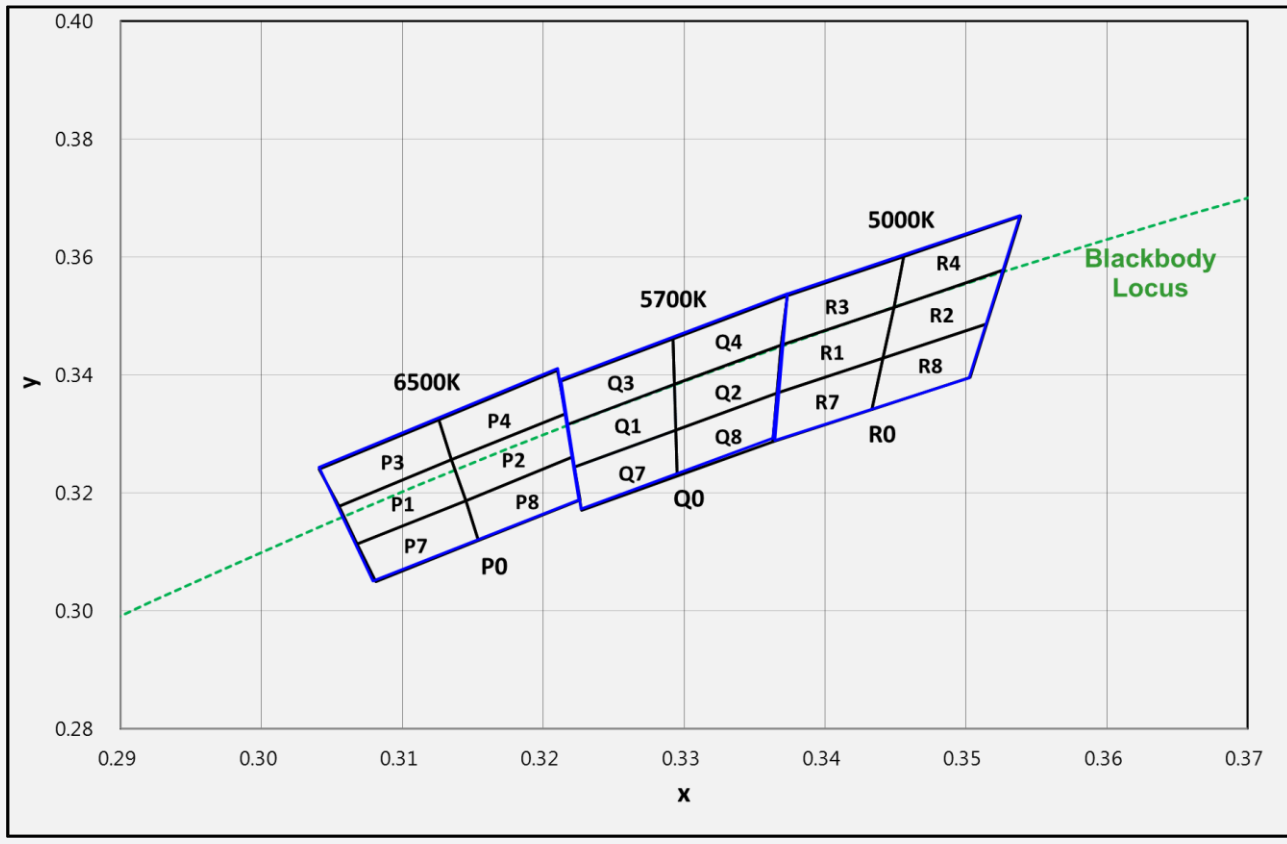
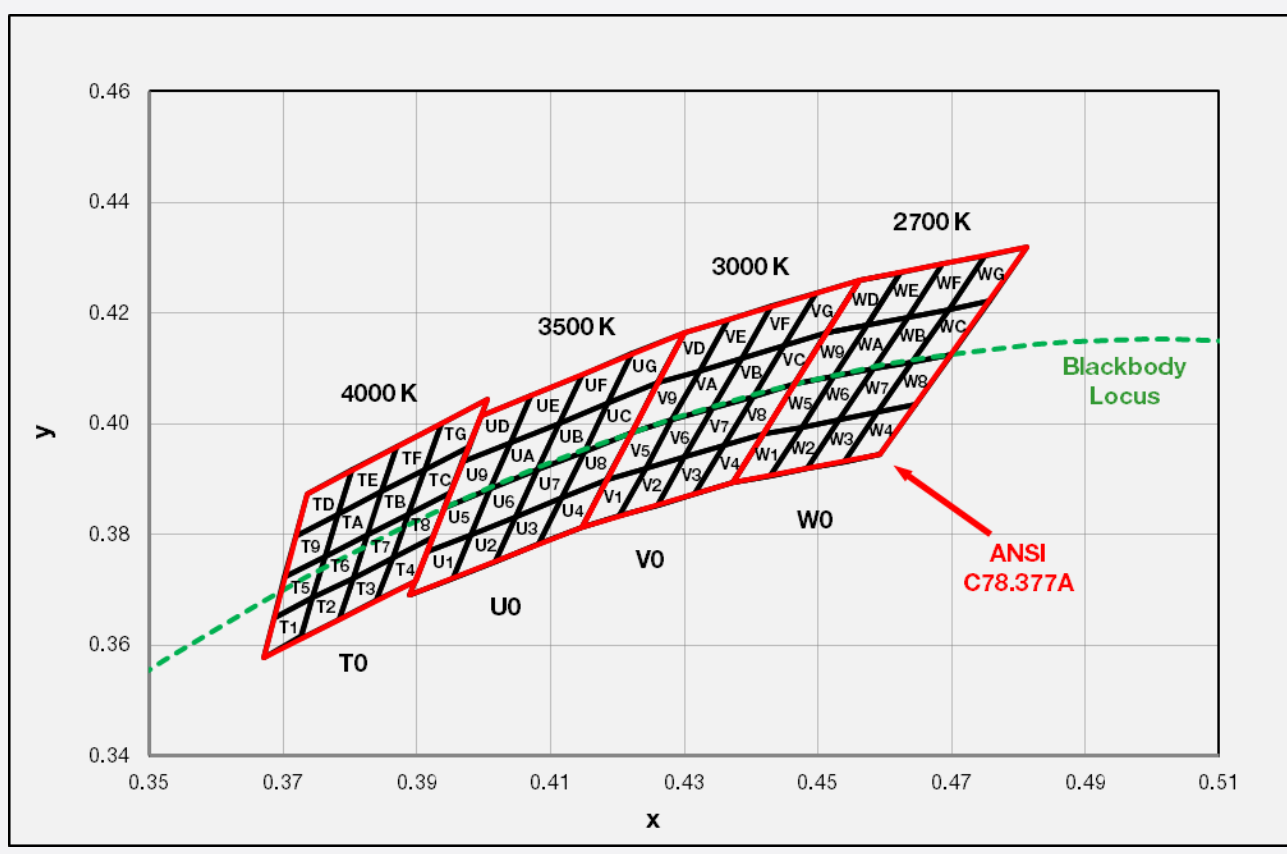

d) Chromaticity Region & Coordinates ($I_F = 150 \text{ mA}$, $T_s = 85 \text{ }^\circ\text{C}$)

| Region | CIE x | CIE y | Region | CIE x | CIE y |
|------------------------|--------|--------|--------|--------|--------|
| W rank (2700 K) | | | | | |
| W1 | 0.4373 | 0.3893 | W9 | 0.4465 | 0.4071 |
| | 0.4418 | 0.3981 | | 0.4513 | 0.4164 |
| | 0.4475 | 0.3994 | | 0.4573 | 0.4178 |
| | 0.4428 | 0.3906 | | 0.4523 | 0.4085 |
| W2 | 0.4428 | 0.3906 | WA | 0.4523 | 0.4085 |
| | 0.4475 | 0.3994 | | 0.4573 | 0.4178 |
| | 0.4532 | 0.4008 | | 0.4634 | 0.4193 |
| | 0.4483 | 0.3919 | | 0.4582 | 0.4099 |
| W3 | 0.4483 | 0.3919 | WB | 0.4582 | 0.4099 |
| | 0.4532 | 0.4008 | | 0.4634 | 0.4193 |
| | 0.4589 | 0.4021 | | 0.4695 | 0.4207 |
| | 0.4538 | 0.3931 | | 0.4641 | 0.4112 |
| W4 | 0.4538 | 0.3931 | WC | 0.4641 | 0.4112 |
| | 0.4589 | 0.4021 | | 0.4695 | 0.4207 |
| | 0.4646 | 0.4034 | | 0.4756 | 0.4221 |
| | 0.4593 | 0.3944 | | 0.4700 | 0.4126 |
| W5 | 0.4418 | 0.3981 | WD | 0.4513 | 0.4164 |
| | 0.4465 | 0.4071 | | 0.4562 | 0.4260 |
| | 0.4523 | 0.4085 | | 0.4624 | 0.4274 |
| | 0.4475 | 0.3994 | | 0.4573 | 0.4178 |
| W6 | 0.4475 | 0.3994 | WE | 0.4573 | 0.4178 |
| | 0.4523 | 0.4085 | | 0.4624 | 0.4274 |
| | 0.4582 | 0.4099 | | 0.4687 | 0.4289 |
| | 0.4532 | 0.4008 | | 0.4634 | 0.4193 |
| W7 | 0.4532 | 0.4008 | WF | 0.4634 | 0.4193 |
| | 0.4582 | 0.4099 | | 0.4687 | 0.4289 |
| | 0.4641 | 0.4112 | | 0.4750 | 0.4304 |
| | 0.4589 | 0.4021 | | 0.4695 | 0.4207 |
| W8 | 0.4589 | 0.4021 | WG | 0.4695 | 0.4207 |
| | 0.4641 | 0.4112 | | 0.4750 | 0.4304 |
| | 0.4700 | 0.4126 | | 0.4813 | 0.4319 |
| | 0.4646 | 0.4034 | | 0.4756 | 0.4221 |

| Region | CIE x | CIE y | Region | CIE x | CIE y |
|------------------------|--------|--------|--------|--------|--------|
| V rank (3000 K) | | | | | |
| V1 | 0.4147 | 0.3814 | V9 | 0.4221 | 0.3984 |
| | 0.4183 | 0.3898 | | 0.4259 | 0.4073 |
| | 0.4242 | 0.3919 | | 0.4322 | 0.4096 |
| | 0.4203 | 0.3833 | | 0.4281 | 0.4006 |
| V2 | 0.4203 | 0.3833 | VA | 0.4281 | 0.4006 |
| | 0.4242 | 0.3919 | | 0.4322 | 0.4096 |
| | 0.4300 | 0.3939 | | 0.4385 | 0.4119 |
| | 0.4259 | 0.3853 | | 0.4342 | 0.4028 |
| V3 | 0.4259 | 0.3853 | VB | 0.4342 | 0.4028 |
| | 0.4300 | 0.3939 | | 0.4385 | 0.4119 |
| | 0.4359 | 0.3960 | | 0.4449 | 0.4141 |
| | 0.4316 | 0.3873 | | 0.4403 | 0.4049 |
| V4 | 0.4316 | 0.3873 | VC | 0.4403 | 0.4049 |
| | 0.4359 | 0.3960 | | 0.4449 | 0.4141 |
| | 0.4418 | 0.3981 | | 0.4513 | 0.4164 |
| | 0.4373 | 0.3893 | | 0.4465 | 0.4071 |
| V5 | 0.4183 | 0.3898 | VD | 0.4259 | 0.4073 |
| | 0.4221 | 0.3984 | | 0.4299 | 0.4165 |
| | 0.4281 | 0.4006 | | 0.4364 | 0.4188 |
| | 0.4242 | 0.3919 | | 0.4322 | 0.4096 |
| V6 | 0.4242 | 0.3919 | VE | 0.4322 | 0.4096 |
| | 0.4281 | 0.4006 | | 0.4364 | 0.4188 |
| | 0.4342 | 0.4028 | | 0.4430 | 0.4212 |
| | 0.4300 | 0.3939 | | 0.4385 | 0.4119 |
| V7 | 0.4300 | 0.3939 | VF | 0.4385 | 0.4119 |
| | 0.4342 | 0.4028 | | 0.4430 | 0.4212 |
| | 0.4403 | 0.4049 | | 0.4496 | 0.4236 |
| | 0.4359 | 0.3960 | | 0.4449 | 0.4141 |
| V8 | 0.4359 | 0.3960 | VG | 0.4449 | 0.4141 |
| | 0.4403 | 0.4049 | | 0.4496 | 0.4236 |
| | 0.4465 | 0.4071 | | 0.4562 | 0.4260 |
| | 0.4418 | 0.3981 | | 0.4513 | 0.4164 |

d) Chromaticity Region & Coordinates

| Region | CIE x | CIE y | Region | CIE x | CIE y |
|------------------------|--------|--------|--------|--------|--------|
| U rank (3500 K) | | | | | |
| U1 | 0.3889 | 0.3690 | U9 | 0.3941 | 0.3848 |
| | 0.3915 | 0.3768 | | 0.3968 | 0.3930 |
| | 0.3981 | 0.3800 | | 0.4040 | 0.3966 |
| | 0.3953 | 0.3720 | | 0.4010 | 0.3882 |
| U2 | 0.3953 | 0.3720 | UA | 0.4010 | 0.3882 |
| | 0.3981 | 0.3800 | | 0.4040 | 0.3966 |
| | 0.4048 | 0.3832 | | 0.4113 | 0.4001 |
| | 0.4017 | 0.3751 | | 0.4080 | 0.3916 |
| U3 | 0.4017 | 0.3751 | UB | 0.4080 | 0.3916 |
| | 0.4048 | 0.3832 | | 0.4113 | 0.4001 |
| | 0.4116 | 0.3865 | | 0.4186 | 0.4037 |
| | 0.4082 | 0.3782 | | 0.4150 | 0.3950 |
| U4 | 0.4082 | 0.3782 | UC | 0.4150 | 0.3950 |
| | 0.4116 | 0.3865 | | 0.4186 | 0.4037 |
| | 0.4183 | 0.3898 | | 0.4259 | 0.4073 |
| | 0.4147 | 0.3814 | | 0.4221 | 0.3984 |
| U5 | 0.3915 | 0.3768 | UD | 0.3968 | 0.3930 |
| | 0.3941 | 0.3848 | | 0.3996 | 0.4015 |
| | 0.4010 | 0.3882 | | 0.4071 | 0.4052 |
| | 0.3981 | 0.3800 | | 0.4040 | 0.3966 |
| U6 | 0.3981 | 0.3800 | UE | 0.4040 | 0.3966 |
| | 0.4010 | 0.3882 | | 0.4071 | 0.4052 |
| | 0.4080 | 0.3916 | | 0.4146 | 0.4089 |
| | 0.4048 | 0.3832 | | 0.4113 | 0.4001 |
| U7 | 0.4048 | 0.3832 | UF | 0.4113 | 0.4001 |
| | 0.4080 | 0.3916 | | 0.4146 | 0.4089 |
| | 0.4150 | 0.3950 | | 0.4222 | 0.4127 |
| | 0.4116 | 0.3865 | | 0.4186 | 0.4037 |
| U8 | 0.4116 | 0.3865 | UG | 0.4186 | 0.4037 |
| | 0.4150 | 0.3950 | | 0.4222 | 0.4127 |
| | 0.4221 | 0.3984 | | 0.4299 | 0.4165 |
| | 0.4183 | 0.3898 | | 0.4259 | 0.4073 |

| Region | CIE x | CIE y | Region | CIE x | CIE y |
|------------------------|--------|--------|--------|--------|--------|
| T rank (4000 K) | | | | | |
| T1 | 0.3670 | 0.3578 | T9 | 0.3702 | 0.3722 |
| | 0.3726 | 0.3612 | | 0.3763 | 0.3760 |
| | 0.3744 | 0.3685 | | 0.3782 | 0.3837 |
| | 0.3686 | 0.3649 | | 0.3719 | 0.3797 |
| T2 | 0.3726 | 0.3612 | TA | 0.3763 | 0.3760 |
| | 0.3783 | 0.3646 | | 0.3825 | 0.3798 |
| | 0.3804 | 0.3721 | | 0.3847 | 0.3877 |
| | 0.3744 | 0.3685 | | 0.3782 | 0.3837 |
| T3 | 0.3783 | 0.3646 | TB | 0.3825 | 0.3798 |
| | 0.3840 | 0.3681 | | 0.3887 | 0.3836 |
| | 0.3863 | 0.3758 | | 0.3912 | 0.3917 |
| | 0.3804 | 0.3721 | | 0.3847 | 0.3877 |
| T4 | 0.3840 | 0.3681 | TC | 0.3887 | 0.3837 |
| | 0.3898 | 0.3716 | | 0.3950 | 0.3875 |
| | 0.3924 | 0.3794 | | 0.3978 | 0.3958 |
| | 0.3863 | 0.3758 | | 0.3912 | 0.3917 |
| T5 | 0.3686 | 0.3649 | TD | 0.3719 | 0.3797 |
| | 0.3744 | 0.3685 | | 0.3782 | 0.3837 |
| | 0.3763 | 0.3760 | | 0.3802 | 0.3916 |
| | 0.3702 | 0.3722 | | 0.3736 | 0.3874 |
| T6 | 0.3744 | 0.3685 | TE | 0.3782 | 0.3837 |
| | 0.3804 | 0.3721 | | 0.3847 | 0.3877 |
| | 0.3825 | 0.3798 | | 0.3869 | 0.3958 |
| | 0.3763 | 0.376 | | 0.3802 | 0.3916 |
| T7 | 0.3804 | 0.3721 | TF | 0.3847 | 0.3877 |
| | 0.3863 | 0.3758 | | 0.3912 | 0.3917 |
| | 0.3887 | 0.3836 | | 0.3937 | 0.4001 |
| | 0.3825 | 0.3798 | | 0.3869 | 0.3958 |
| T8 | 0.3863 | 0.3758 | TG | 0.3912 | 0.3917 |
| | 0.3924 | 0.3794 | | 0.3978 | 0.3958 |
| | 0.3950 | 0.3875 | | 0.4006 | 0.4044 |
| | 0.3887 | 0.3836 | | 0.3937 | 0.4001 |

d) Chromaticity Region & Coordinates

| Region | CIE x | CIE y | Region | CIE x | CIE y |
|------------------------|--------|--------|--------|--------|--------|
| R rank (5000 K) | | | | | |
| R1 | 0.3366 | 0.3369 | R4 | 0.3449 | 0.3515 |
| | 0.3441 | 0.3428 | | 0.3527 | 0.3578 |
| | 0.3449 | 0.3515 | | 0.3539 | 0.3669 |
| | 0.3369 | 0.3451 | | 0.3456 | 0.3601 |
| R2 | 0.3441 | 0.3428 | R7 | 0.3363 | 0.3287 |
| | 0.3515 | 0.3487 | | 0.3433 | 0.3341 |
| | 0.3527 | 0.3578 | | 0.3441 | 0.3428 |
| | 0.3449 | 0.3515 | | 0.3366 | 0.3369 |
| R3 | 0.3369 | 0.3451 | R8 | 0.3433 | 0.3341 |
| | 0.3449 | 0.3515 | | 0.3503 | 0.3396 |
| | 0.3456 | 0.3601 | | 0.3515 | 0.3487 |
| | 0.3373 | 0.3534 | | 0.3441 | 0.3428 |

| Region | CIE x | CIE y | Region | CIE x | CIE y |
|------------------------|--------|--------|--------|--------|--------|
| Q rank (5700 K) | | | | | |
| Q1 | 0.3222 | 0.3243 | Q4 | 0.3293 | 0.3384 |
| | 0.3294 | 0.3306 | | 0.3369 | 0.3451 |
| | 0.3293 | 0.3384 | | 0.3373 | 0.3534 |
| | 0.3217 | 0.3316 | | 0.3292 | 0.3461 |
| Q2 | 0.3294 | 0.3306 | Q7 | 0.3227 | 0.3170 |
| | 0.3366 | 0.3369 | | 0.3295 | 0.3228 |
| | 0.3369 | 0.3451 | | 0.3294 | 0.3306 |
| | 0.3293 | 0.3384 | | 0.3222 | 0.3243 |
| Q3 | 0.3217 | 0.3316 | Q8 | 0.3295 | 0.3228 |
| | 0.3293 | 0.3384 | | 0.3363 | 0.3287 |
| | 0.3292 | 0.3461 | | 0.3366 | 0.3369 |
| | 0.3212 | 0.3389 | | 0.3294 | 0.3306 |

d) Chromaticity Region & Coordinates

| Region | CIE x | CIE y | Region | CIE x | CIE y |
|------------------------|--------|--------|--------|--------|--------|
| P rank (6500 K) | | | | | |
| P1 | 0.3068 | 0.3113 | P4 | 0.3135 | 0.3256 |
| | 0.3145 | 0.3187 | | 0.3216 | 0.3334 |
| | 0.3135 | 0.3256 | | 0.3210 | 0.3408 |
| | 0.3055 | 0.3177 | | 0.3126 | 0.3324 |
| P2 | 0.3145 | 0.3187 | P7 | 0.3081 | 0.3049 |
| | 0.3221 | 0.3261 | | 0.3154 | 0.3119 |
| | 0.3216 | 0.3334 | | 0.3145 | 0.3187 |
| | 0.3135 | 0.3256 | | 0.3068 | 0.3113 |
| P3 | 0.3055 | 0.3177 | P8 | 0.3154 | 0.3119 |
| | 0.3135 | 0.3256 | | 0.3226 | 0.3188 |
| | 0.3126 | 0.3324 | | 0.3221 | 0.3261 |
| | 0.3041 | 0.3240 | | 0.3145 | 0.3187 |

Note:

Samsung maintains measurement tolerance of: $C_x, C_y = \pm 0.005$

3. Typical Characteristics Graphs

a) Spectrum Distribution ($I_f = 150 \text{ mA}$, $T_s = 85 \text{ }^\circ\text{C}$)

CCT: 2700 K

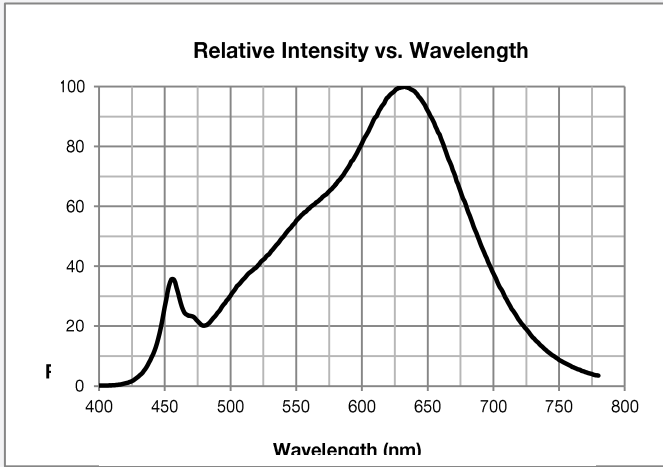

CCT: 3000 K

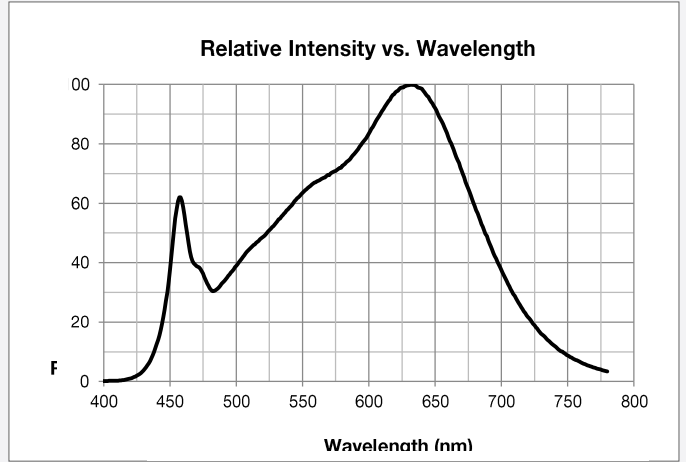

CCT: 3500 K

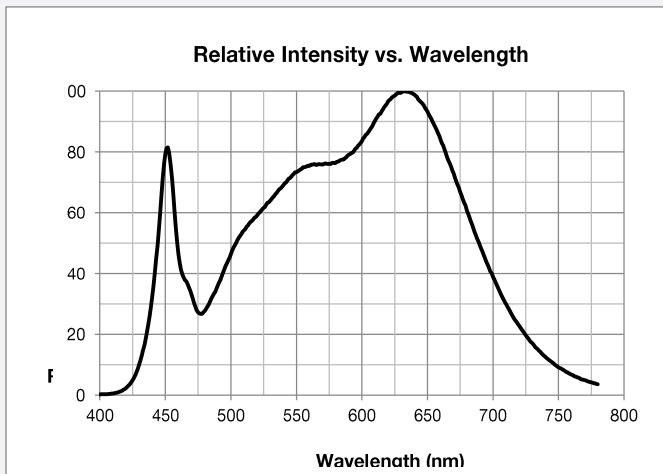

CCT: 4000 K

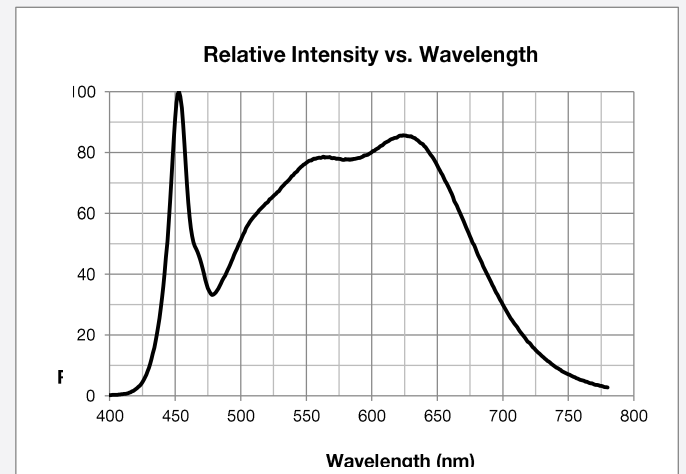

CCT: 5000 K

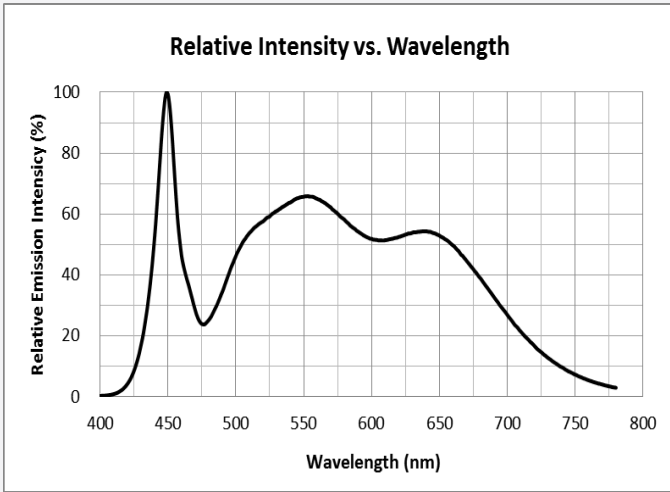

CCT: 5700 K

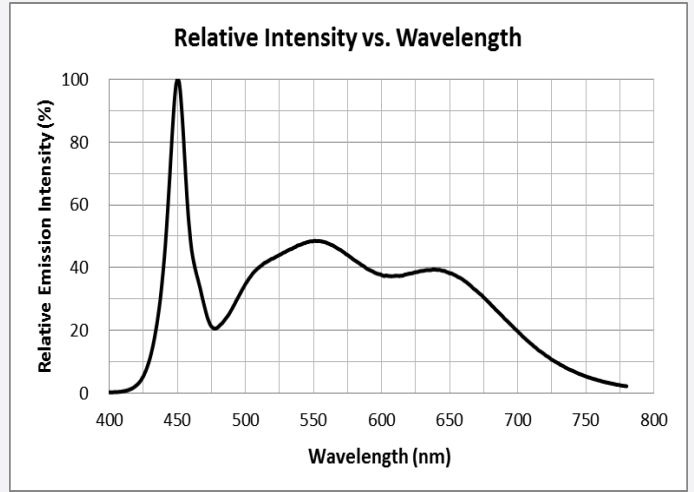

CCT: 6500K

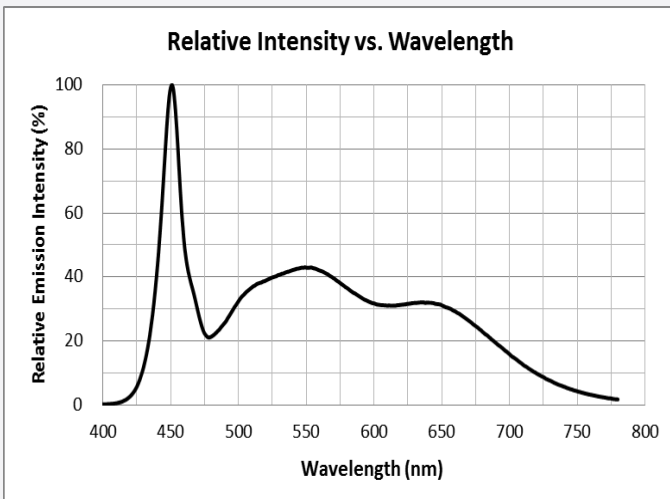

b) Forward Current Characteristics ($T_s = 85^\circ\text{C}$)

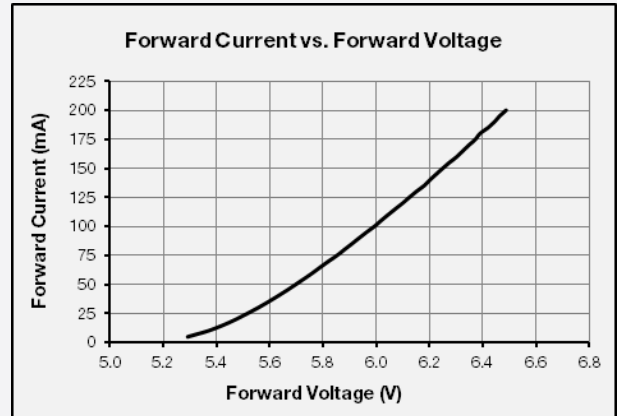
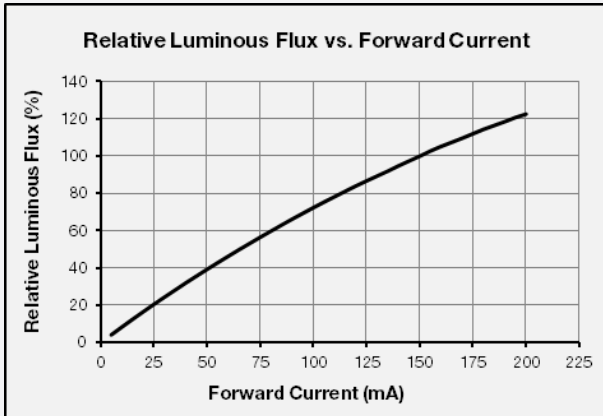

c) Temperature Characteristics ($I_f = 150\text{ mA}$)

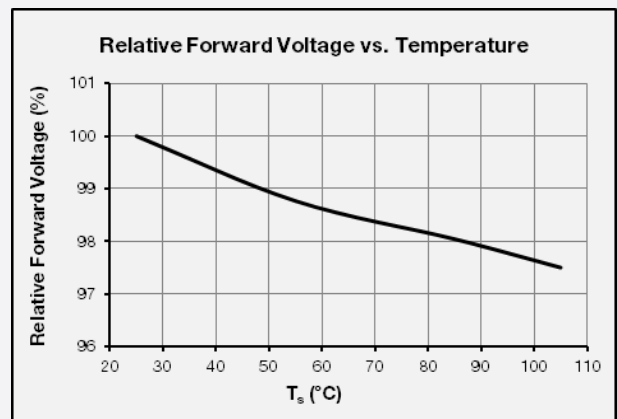
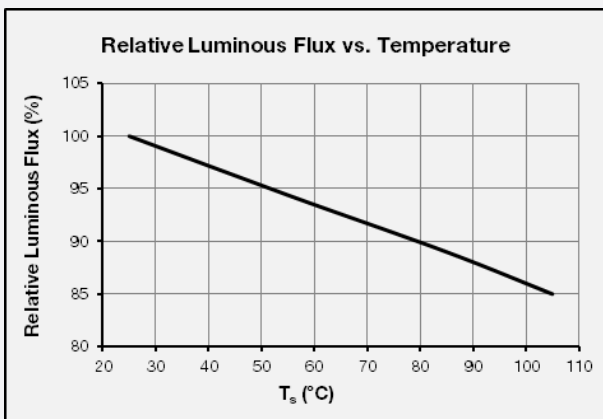

d) Color Shift Characteristics

$T_s = 85\text{ }^\circ\text{C}$

$I_F = 150\text{ mA}$

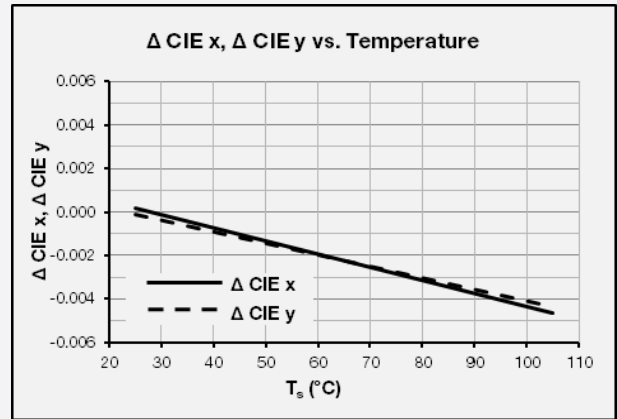
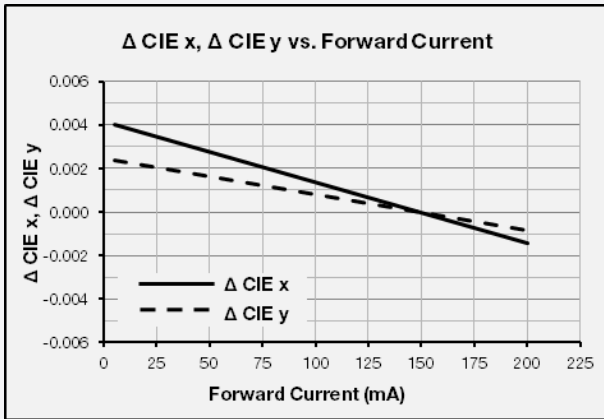

e) Derating Curve

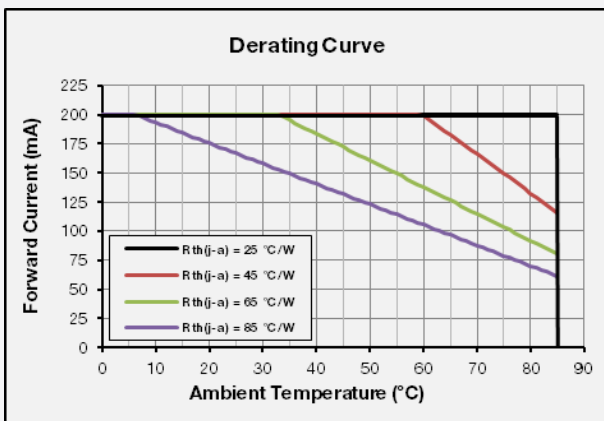

f) Beam Angle Characteristics ($I_F = 150\text{ mA}$, $T_s = 85\text{ }^\circ\text{C}$)

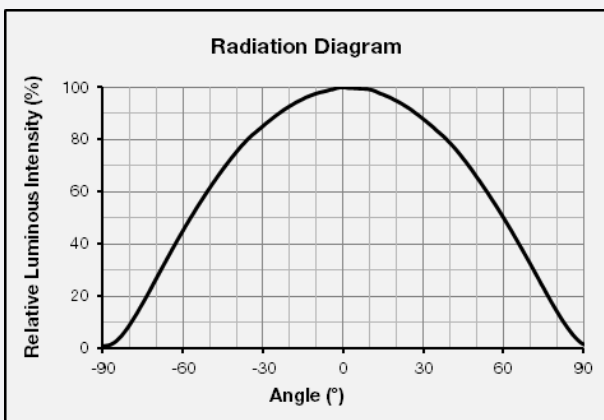

4. Outline Drawing & Dimension

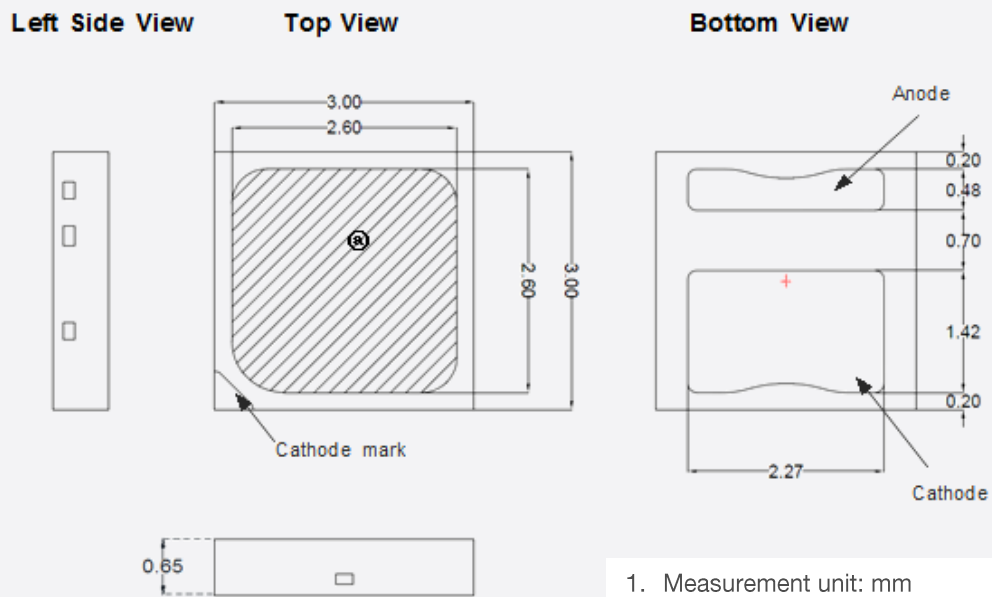

1. Measurement unit: mm
2. Tolerance: ± 0.10 mm
3. Do not place pressure on the encapsulation resin ②

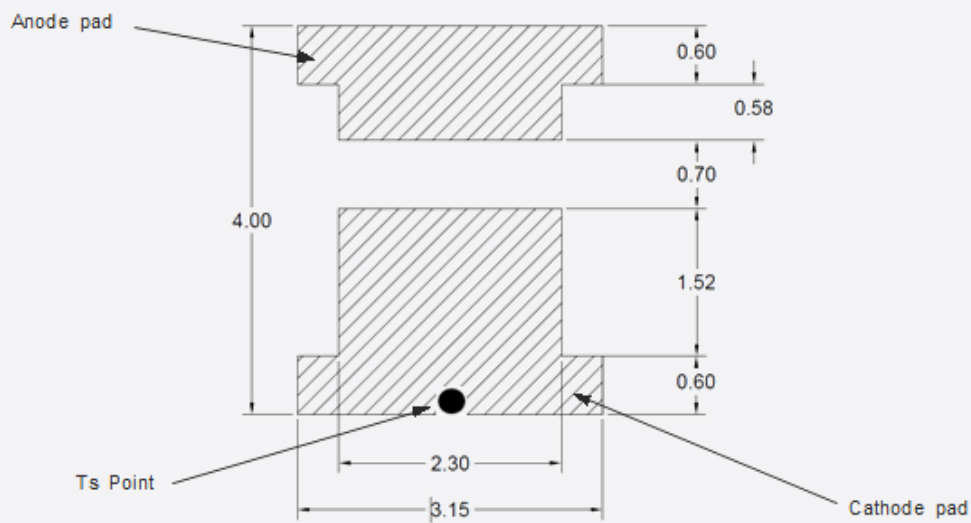

Recommended Land Pattern

Notes:

- 1) This LED has built-in ESD protection device(s) connected in parallel to LED chip(s).
- 2) T_s point and measurement method:
 - ① Measure one point at the cathode pad. If necessary, remove PSR of PCB to reach T_s point.
 - ② All pads must be soldered to the PCB to dissipate heat properly, otherwise the LED can be damaged.

Precautions:

- 1) Pressure on the LEDs will influence to the reliability of the LEDs. Precautions should be taken to avoid strong pressure on the LEDs. Do not put stress on the LEDs during heating.
- 2) Re-soldering should not be done after the LEDs have been soldered. If re-soldering is unavoidable, LED's characteristics should be carefully checked before and after such repair.
- 3) Do not stack assembled PCBs together. Since materials of LEDs is soft, abrasion between two PCB assembled with LED might cause catastrophic failure of the LEDs.

5. Reliability Test Items and Conditions

a) Test Items

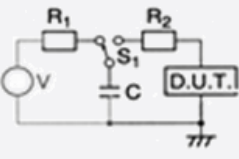
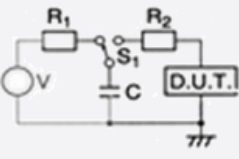
| Test Item | Test Condition | Test Hour / Cycle | Sample Size |
|-------------------------------------|--|--|---------------|
| Room Temperature Life Test | 25 °C, DC 200 mA | 1000 h | 22 |
| High Temperature Life Test | 85 °C, DC 200 mA | 1000 h | 22 |
| High Temperature Humidity Life Test | 85 °C, 85 % RH, DC 200 mA | 1000 h | 22 |
| Low Temperature Life Test | -40 °C, DC 200 mA | 1000 h | 22 |
| Powered Temperature Cycle Test | -45 °C / 20 min ↔ 85 °C / 20 min, sweep 100 min cycle on/off: each 5 min, DC 200 mA | 100 cycles | 22 |
| Thermal Cycle | -45 °C / 15 min ↔ 125 °C / 15 min → Hot plate 180 °C | 500 cycles | 100 |
| High Temperature Storage | 120 °C | 1000 h | 11 |
| Low Temperature Storage | -40 °C | 1000 h | 11 |
| ESD (HBM) |  | R ₁ : 10 MΩ R ₂ : 1.5 kΩ C: 100 pF V: ±5 kV | 5 times 30 |
| ESD (MM) |  | R ₁ : 10 MΩ R ₂ : 0 C: 200 pF V: ±0.5 kV | 5 times 30 |
| Vibration Test | 20~2000~20 Hz, 200 m/s ² , sweep 4 min X, Y, Z 3 direction, each 1 cycle | 4 cycles | 11 |
| Mechanical Shock Test | 1500 g, 0.5 ms 3 shocks each X-Y-Z axis | 5 cycles | 11 |

b) Criteria for Judging the Damage

| Item | Symbol | Test Condition (T _s = 25 °C) | Limit | |
|-----------------|----------------|--|-------------------|-------------------|
| | | | Min. | Max. |
| Forward Voltage | V _F | I _F = 150 mA | Init. Value * 0.9 | Init. Value * 1.1 |
| Luminous Flux | Φ _v | I _F = 150 mA | Init. Value * 0.7 | Init. Value * 1.1 |

6. Soldering Conditions

a) Reflow Conditions (Pb free)

Reflow frequency: 2 times max.

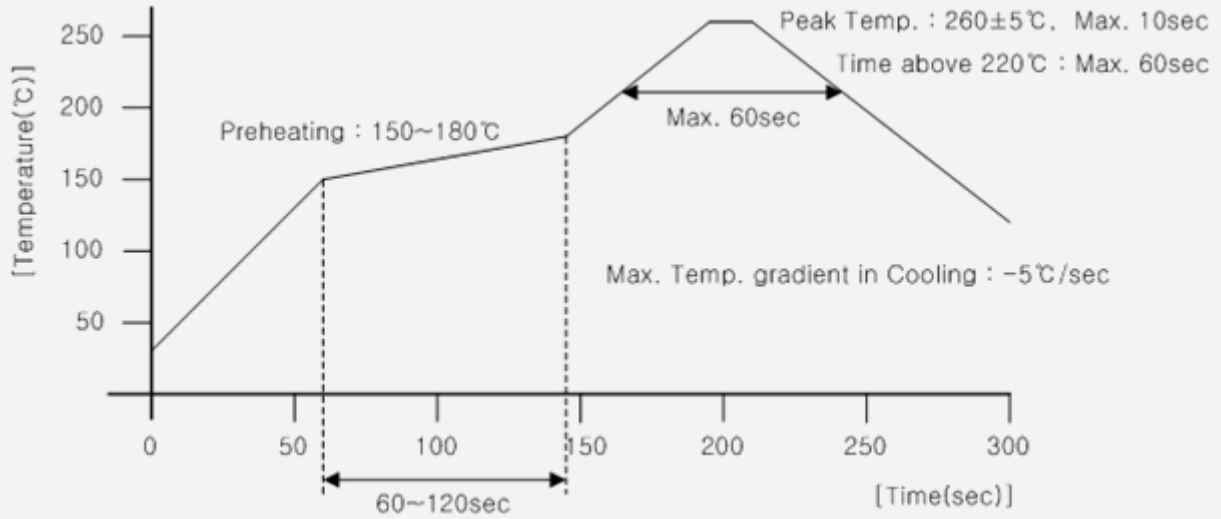

b) Manual Soldering Conditions

Not more than 5 seconds @ max. 300°C , under soldering iron.

7. Tape & Reel

a) Taping Dimension

(unit: mm)

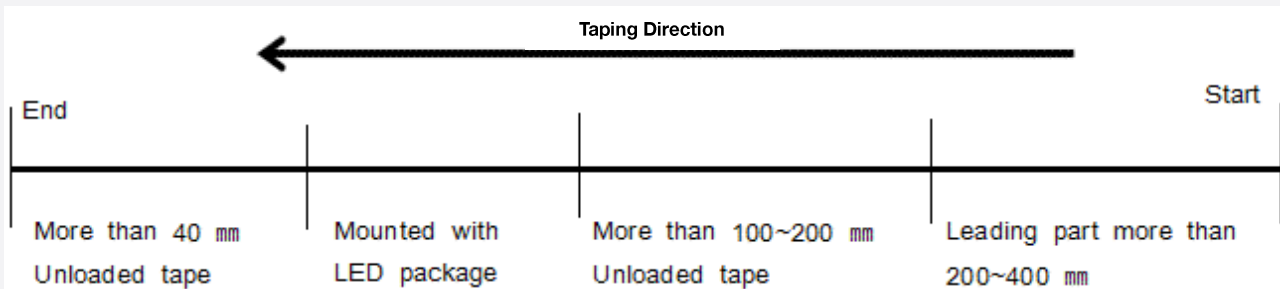
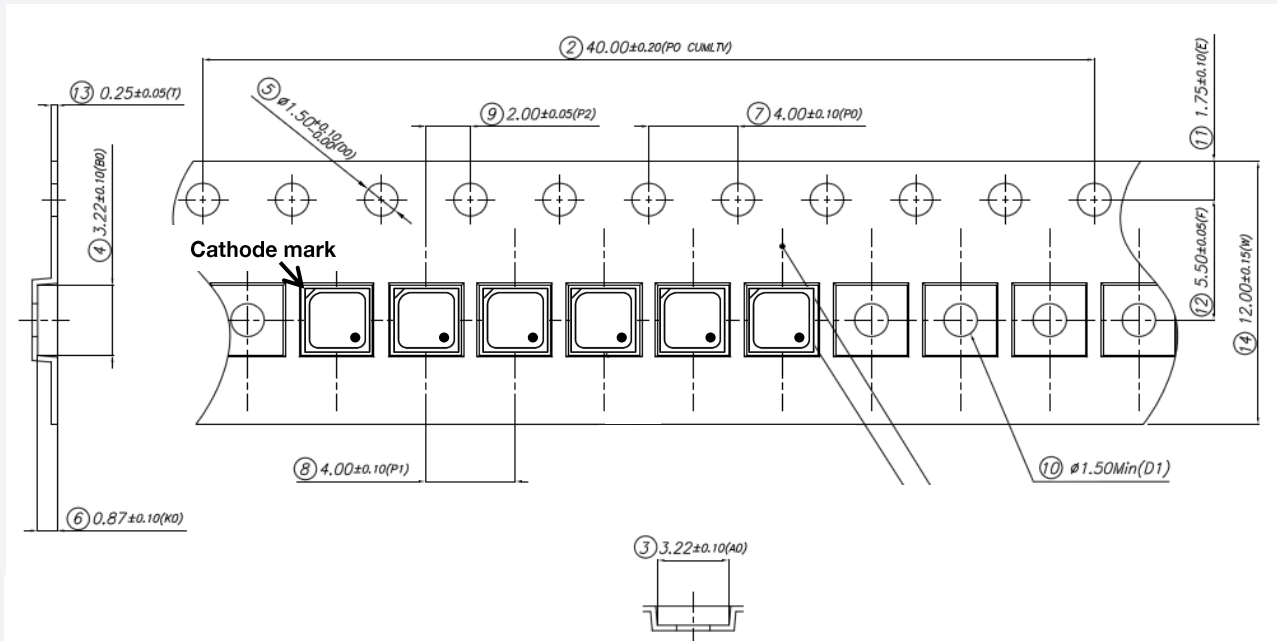

b) Reel Dimension

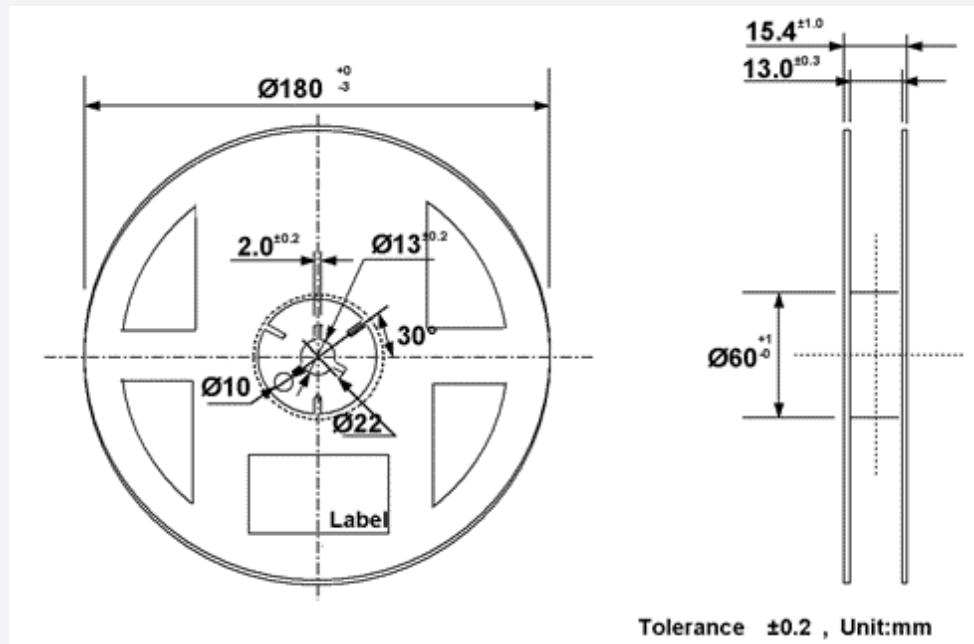
**Notes:**

- 1) Quantity: The quantity/reel is 4,000 pcs
- 2) Cumulative tolerance: Cumulative tolerance / 10 pitches is ± 0.2 mm
- 3) Adhesion strength of cover tape: Adhesion strength is 0.1-0.7 N when the cover tape is turned off from the carrier tape at 10° angle to the carrier tape
- 4) Packaging: P/N, Manufacturing data code no. and quantity are indicated on the aluminum packing bag

8. Label Structure

a) Label Structure

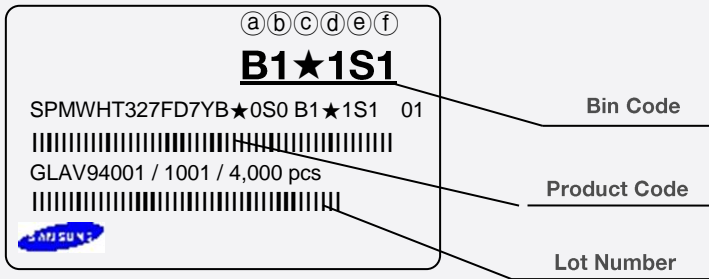

Note: Denoted bin code and product code above is only an example
'★' means all kind of Chromaticity Coordinate Ranks

Bin Code:

- ⒶⒷ: Forward Voltage bin (refer to page 7)
- ⒸⒹ: Chromaticity bin (refer to page 9~12)
- ⒺⒻ: Luminous Flux bin (refer to page 4-5)

b) Lot Number

The lot number is composed of the following characters:

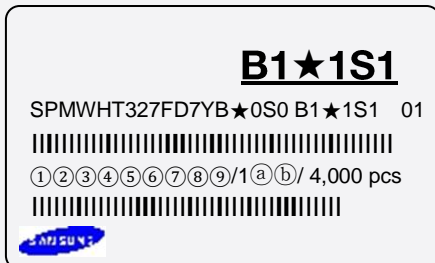

①②③④⑤⑥⑦⑧⑨ / 1ⒶⒷⒸ / 4,000 pcs

- ① : Production site (S: Giheung, Korea, G: Tianjin, China)
- ② : L (LED)
- ③ : Product state (A: Normal, B: Bulk, C: First Production, R: Reproduction, S: Sample)
- ④ : Year (Y: 2014, Z: 2015, A: 2016, ...)
- ⑤ : Month (1~9, A, B, C)
- ⑥ : Day (1~9, A, B~V)
- ⑦⑧⑨ : Product serial number (001 ~ 999)
- ⒶⒷⒸ : Reel number (001 ~ 999)

9. Packing Structure

a-1) Packing Process

Reel

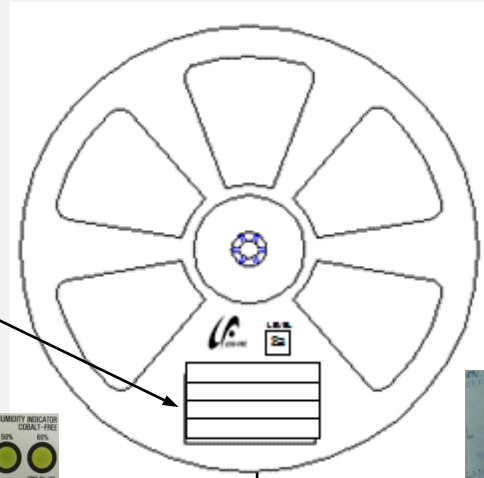
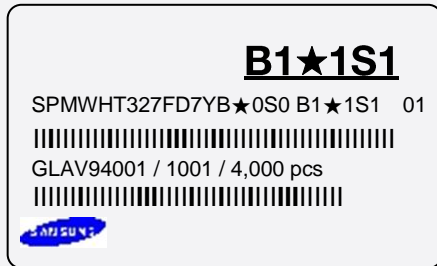

Aluminum Vinyl Packing Bag

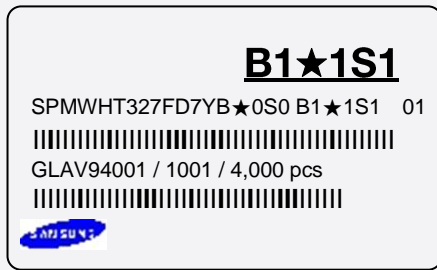

Outer Box

Material: Paper (SW3B(B))

| Type | Size (mm) | | | Note |
|----------|-----------|---------|---------|----------------|
| | L | W | H | |
| 7 inch L | 245 ± 5 | 220 ± 5 | 182 ± 5 | Up to 10 reels |
| 7 inch S | 245 ± 5 | 220 ± 5 | 86 ± 5 | Up to 5 reels |

Side Label

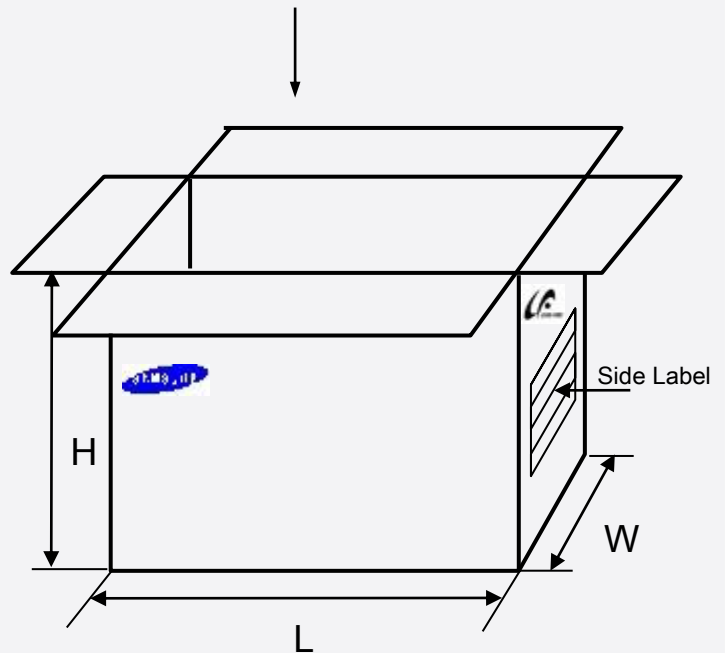
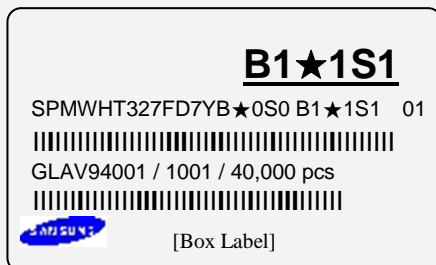

b) Aluminum Vinyl Packing Bag



CAUTION

This bag contains
MOISTURE SENSITIVE DEVICES

LEVEL
2a

1. Shelf life in sealed bag: 12 months at <40°C and <90% relative humidity (RH)
2. Peak package body temperature: 240 °C
3. After this bag is opened, devices that will be subjected to reflow solder or other high temperature processes must be:
 - a. Mounted within 672 hours at factory conditions of equal to or less than 30°C /60% RH, or
 - b. Stored at <10% RH
4. Devices require bake, before mounting, if:
 - a. Humidity Indicator Card is >60% when read at 23±5°C, or
 - b. 2a is not met.
5. If baking is required, devices must be baked for 10 - 24 hours at 60±5°C

Note: If device containers cannot be subjected to high temperature or shorter bake times are desired, reference IPC/JEDEC J-STD-033 for bake procedure.

Bag seal due date: _____
(If blank, see code label)

Note: Level and body temperature by IPC/JEDEC J-STD-020

B1★1S1



SPMWHT327FD7YB★0S1 B1★1S1 01

|||||

GLAV94001 / 1001 / 4,000 pcs

|||||

SAMSUNG

ATTENTION

OBSERVE PRECAUTIONS
FOR HANDLING
ELECTROSTATIC
SENSITIVE
DEVICES



■ 주의 사항

이 알루미늄 지퍼 백은 습기 및 정전기로부터 제품을 보호하기 위하여 제작되었습니다. 개봉 후에는 즉시 솔더 작업을 실시하는 것을 권장합니다.

습기 및 정전기로부터 제품을 보호 하기 위해서 개봉 후 사용하지 않는 자재는 본 팩에 넣어 보관 하시기 바랍니다. 사용하지 않는 자재를 본 팩에 넣을 때는 반드시 동봉된 드라이 팩과 함께 넣고 지퍼부분을 완전하게 밀봉하여 주시기 바랍니다.

■ Important

This Al Zipper bag is designed to protect the enclosed products from moisture and ESD. Once opened, the products should be soldered onto the printed circuit board immediately. When not in use, please do not leave the products unprotected by the Al Zipper Bag. To repack unused products., please ensure the zip-lock is completely sealed with the dry pack left inside.

c) Silica Gel & Humidity Indicator Card inside Aluminum Vinyl Bag



10. Precautions in Handling & Use

- 1) For over-current protection, users are recommended to apply resistors connected in series with the LEDs to mitigate sudden change of the forward current caused by shift of forward voltage.
- 2) This device should not be used in any type of fluid such as water, oil, organic solvent, etc. When cleaning is required, IPA is recommended as the cleaning agent. Some solvent-based cleaning agent may damage the silicone resins used in the device.
- 3) When the device is in operation, the forward current should be carefully determined considering the maximum ambient temperature and corresponding junction temperature.
- 4) LEDs must be stored in a clean environment. If the LEDs are to be stored for three months or more after being shipped from Samsung, they should be packed with a nitrogen-filled container (shelf life of sealed bags is 12 months at temperature 0~40 °C, 0~90 % RH).
- 5) After storage bag is opened, device subjected to soldering, solder reflow, or other high temperature processes must be:
 - a. Mounted within 672 hours (28 days) at an assembly line with a condition of no more than 30 °C / 60 % RH, or
 - b. Stored at <10 % RH
- 6) Repack unused devices with anti-moisture packing, fold to close any opening and then store in a dry place.
- 7) Devices require baking before mounting, if humidity card reading is >60 % at 23 ± 5 °C.
- 8) Devices must be baked for 10~24 hours at 60 ± 5 °C, if baking is required.
- 9) The LEDs are sensitive to the static electricity and surge current. It is recommended to use a wrist band or anti-electrostatic glove when handling the LEDs. If voltage exceeding the absolute maximum rating is applied to LEDs, it may cause damage or even destruction to LED devices. Damaged LEDs may show some unusual characteristics such as increase in leakage current, lowered turn-on voltage, or abnormal lighting of LEDs at low current.
- 10) VOCs (Volatile Organic Compounds) can be generated from adhesives, flux, hardener or organic additives used in luminaires (fixtures). Transparent LED silicone encapsulant is permeable to those chemicals and they may lead to a discoloration of encapsulant when they exposed to heat or light. This phenomenon can cause a significant loss of light emitted (output) from the luminaires. In order to prevent these problems, we recommend users to know the physical properties of materials used in luminaires and they must be carefully selected.
- 11) Risk of sulfurization (or tarnishing)
 The LED from Samsung uses a silver-plated lead frame and its surface color may change to black (or dark colored) when it is exposed to sulfur (S), chlorine (Cl) or other halogen compound. Sulfurization of lead frame may cause intensity degradation, change of chromaticity coordinates and, in extreme cases, open circuit. It requires caution. Due to possible sulfurization of lead frame, LED should not be used and stored together with oxidizing substances made of materials such as rubber, plain paper, lead solder cream, etc.

Legal and additional information.

[About Samsung Electronics Co., Ltd.](#)

Samsung Electronics Co., Ltd. is a global leader in technology, opening new possibilities for people everywhere. Through relentless innovation and discovery, we are transforming the worlds of TVs, smartphones, tablets, PCs, cameras, home appliances, printers, LTE systems, medical devices, semiconductors and LED solutions. We employ 286,000 people across 80 countries with annual sales of US\$216.7 billion. To discover more, please visit www.samsungled.com.

Copyright © 2015 Samsung Electronics Co., Ltd. All rights reserved.
Samsung is a registered trademark of Samsung Electronics Co., Ltd.
Specifications and designs are subject to change without notice. Non-metric weights and measurements are approximate. All data were deemed correct at time of creation. Samsung is not liable for errors or omissions. All brand, product, service names and logos are trademarks and/or registered trademarks of their respective owners and are hereby recognized and acknowledged.

Samsung Electronics Co., Ltd.
95, Samsung 2-ro
Giheung-gu
Yongin-si, Gyeonggi-do, 446-711
KOREA

www.samsungled.com



Looking for pricing, stock, or lifecycle information?

Click below to explore more details on WIN SOURCE:

- ⊖ [View SPMWHT327FD7GBT0S0 on WIN SOURCE](#)
- ⊖ [Samsung Information](#)

Optimize Your Supply Chain with WIN SOURCE Solutions

- ✓ Global Sourcing Solution
- ✓ Obsolete Management
- ✓ Cost Control Management
- ✓ Shortage Management
- ✓ Alternative Solution
- ✓ Excess Inventory Management