



**THE DATASHEET OF
SPMWHT541MP5WAUMS5**



Middle Power LED Series
5630 MacAdam 3 step

LM561B Plus



Improved efficacy and performance of LM561B to provide better solution



Features & Benefits

- 0.3 W class middle power LED
- Mold resin for high reliability
- Standard form factor for design flexibility (5.6 × 3.0 mm)

Table of Contents

1.	Characteristics	-----	3
2.	Product Code Information	-----	5
3.	Typical Characteristics Graphs	-----	10
4.	Outline Drawing & Dimension	-----	13
5.	Reliability Test Items & Conditions	-----	14
6.	Soldering Conditions	-----	15
7.	Tape & Reel	-----	16
8.	Label Structure	-----	18
9.	Packing Structure	-----	19
10.	Precautions in Handling & Use	-----	22

1. Characteristics

a) Absolute Maximum Rating

Item	Symbol	Rating	Unit	Condition
Ambient / Operating Temperature	T_a	-40 ~ +85	°C	-
Storage Temperature	T_{stg}	-40 ~ +120	°C	-
LED Junction Temperature	T_j	110	°C	-
Forward Current	I_F	180	mA	-
Peak Pulsed Forward Current	I_{fp}	300	mA	Duty 1/10, pulse width 10 ms
Assembly Process Temperature	-	260 <10	°C s	-
ESD (HBM)	-	±5	kV	-

b) Electro-optical Characteristics ($I_F = 65 \text{ mA}$, $T_s = 25 \text{ °C}$)

Item	Unit	CRI (R _a) Min.	Nominal CCT (K)	Rank	Bin	Min.	Typ.	Max.				
Forward Voltage (V _F)	V			WA	AZ	2.7	-	2.8				
					A1	2.8	-	2.9				
					A2	2.9	-	3.0				
					A3	3.0	-	3.1				
					A4	3.1	-	3.2				
					2700	S4	30.0	-	32.0			
						S5	32.0	-	34.0			
						3000	S4	30.5	-	32.5		
							S5	32.5	-	34.5		
					3500	S4	31.0	-	33.0			
S5	33.0	-	35.0									
Luminous Flux (Φ _v)	lm	80	4000		S4	32.0	-	34.0				
					S5	34.0	-	36.0				
			5000		S4	33.0	-	35.0				
					S5	35.0	-	37.0				
			5700		S4	32.5	-	34.5				
					S5	34.5	-	36.5				
			6500		S4	32.0	-	34.0				
					S5	34.0	-	36.0				
			Reverse Voltage (@ 5 mA)		V					0.7	-	1.2
			Color Rendering Index (R _a)		-			5		80	-	-
Special CRI (R9)	-					0	-	-				
Thermal Resistance (junction to solder point)	°C/W					-	15	-				
Beam Angle	°					-	120	-				

Note:

Samsung maintains measurement tolerance of: forward voltage = ±0.1 V, luminous flux = ±5 %, CRI = ±3, R9 = ±6.5

2. Product Code Information

1	2	3	4	5	6	7	8	9	10	11	12	13	14	15	16	17	18
S	P	M	W	H	T	5	4	1	M	P	5	W	K	R	U	S	4

Digit	PKG Information	Code	Specification
1 2 3	Samsung Package Middle Power	SPM	
4 5	Color	WH	White
6	Product Version	T	
7 8 9	Form Factor	541	5.6 x 3.0 x 0.7 mm; 4 pads;
10	Sorting Current (mA)	M	65 mA
11	Chromaticity Coordinates	P	
12	CRI	5	Min. 80
13 14	Forward Voltage (V)	WA WK	2.7~3.2V (2,500 pcs/Reel) 2.7~3.2V (10,000 pcs/Reel)
15 16	CCT (K)	WU VU UU TU RU QU PU	2700 WU 3000 VU 3500 UU 4000 TU 5000 RU 5700 QU 6500 PU Bin Code: TU RU QU PU *U* (MacAdam 3-step ellipse bin)
17 18	Luminous Flux	S4 S5	Bin Code: S4 S5

a) Luminous Flux Bins($I_F = 65 \text{ mA}$, $T_s = 25^\circ\text{C}$)

CRI (R_a) Min.	Nominal CCT (K)	Product Code	Flux Bin	Flux Range (Φ_v , lm)
80	2700	SPMWHT541MP5W◆WUS4	S4	30.0 ~ 32.0
		SPMWHT541MP5W◆WUS5	S5	32.0 ~ 34.0
	3000	SPMWHT541MP5W◆VUS4	S4	30.5 ~ 32.5
		SPMWHT541MP5W◆VUS5	S5	32.5 ~ 34.5
	3500	SPMWHT541MP5W◆UUS4	S4	31.0 ~ 33.0
		SPMWHT541MP5W◆UUS5	S5	33.0 ~ 35.0
	4000	SPMWHT541MP5W◆TUS4	S4	32.0 ~34.0
		SPMWHT541MP5W◆TUS5	S5	34.0 ~36.0
	5000	SPMWHT541MP5W◆RUS4	S4	33.0 ~35.0
		SPMWHT541MP5W◆RUS5	S5	35.0 ~37.0
	5700	SPMWHT541MP5W◆QUS4	S4	32.5 ~34.5
		SPMWHT541MP5W◆QUS5	S5	34.5 ~36.5
	6500	SPMWHT541MP5W◆PUS4	S4	32.0 ~34.0
		SPMWHT541MP5W◆PUS5	S5	34.0 ~36.0

Note:

◆ can be "A" (2,500pcs) or "K" (10,000pcs) of reel taping

b) Color Bins ($I_f = 65 \text{ mA}$, $T_s = 25 \text{ }^\circ\text{C}$)

CRI (R_a) Min.	Nominal CCT (K)	Product Code	Color Rank	Chromaticity Bins
80	2700	SPMWHT541MP5W◆WUS4	WU (MacAdam 3-step)	WU
		SPMWHT541MP5W◆WUS5		
	3000	SPMWHT541MP5W◆VUS4	VU (MacAdam 3-step)	VU
		SPMWHT541MP5W◆VUS5		
	3500	SPMWHT541MP5W◆UUS4	UU (MacAdam 3-step)	UU
		SPMWHT541MP5W◆UUS5		
	4000	SPMWHT541MP5W◆TUS4	TU (MacAdam 3-step)	TU
		SPMWHT541MP5W◆TUS5		
	5000	SPMWHT541MP5W◆RUS4	RU (MacAdam 3-step)	RU
		SPMWHT541MP5W◆RUS5		
	5700	SPMWHT541MP5W◆QUS4	QU (MacAdam 3-step)	QU
		SPMWHT541MP5W◆QUS5		
	6500	SPMWHT541MP5W◆PUS4	PU (MacAdam 3-step)	PU
		SPMWHT541MP5W◆PUS5		

Note:

◆ can be "A" (2,500pcs) or "K" (10,000pcs) of reel taping

d) Voltage Bins ($I_F = 65 \text{ mA}$, $T_s = 25 \text{ }^\circ\text{C}$)

CRI (R_a) Min.	Nominal CCT (K)	Product Code	Voltage Rank	Voltage Bin	Voltage Range (V)
-	-	-	WA (WK)	AZ	2.7 ~ 2.8
				A1	2.8 ~ 2.9
				A2	2.9 ~ 3.0
				A3	3.0 ~ 3.1
				A4	3.1 ~ 3.2

e) Chromaticity Region & Coordinates ($I_F = 65 \text{ mA}$, $T_s = 25^\circ\text{C}$)

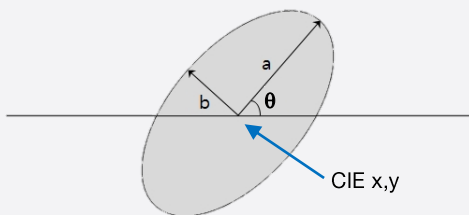
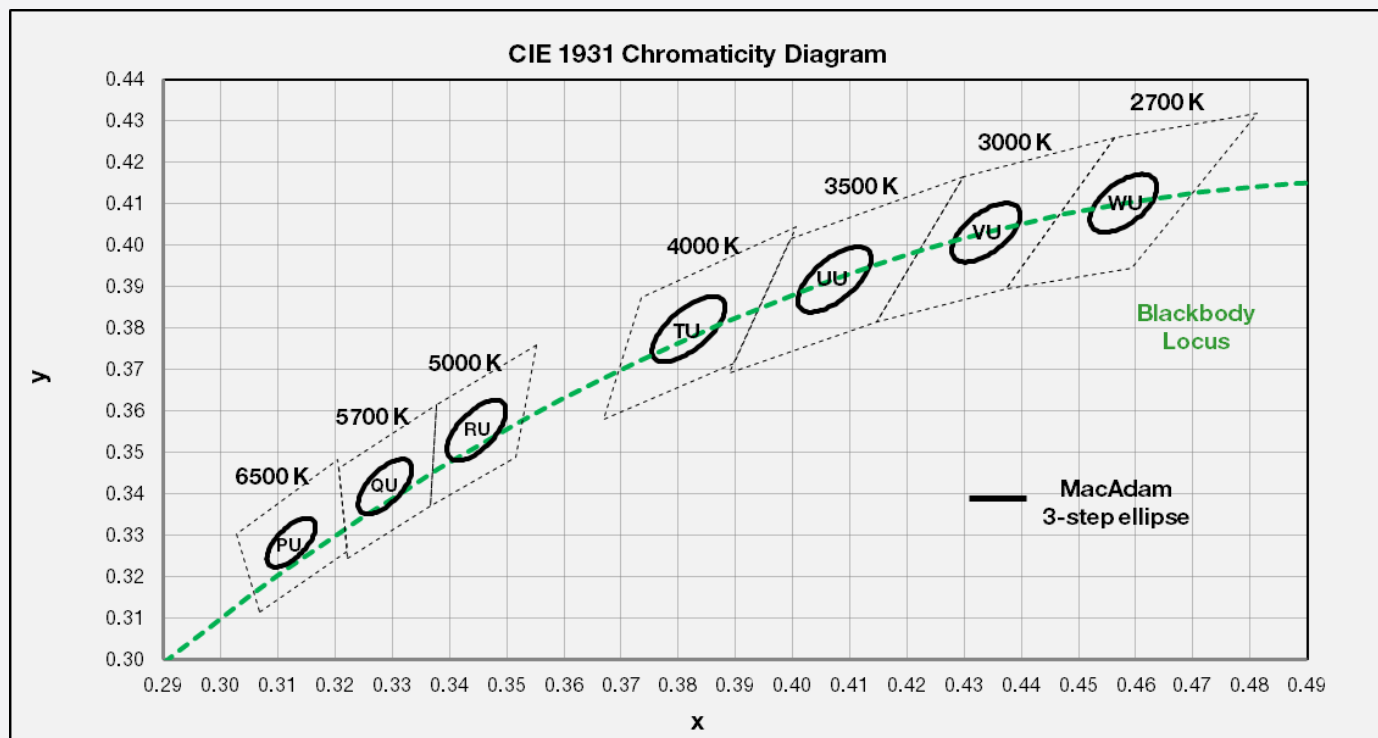

MacAdam 3-step Ellipse (WU)				
CIE x	CIE y	θ	a	b
0.4578	0.4101	53.70	0.0081	0.0042

MacAdam 3-step Ellipse (VU)				
CIE x	CIE y	θ	a	b
0.4338	0.4030	53.22	0.0083	0.0041

MacAdam 3-step Ellipse (UU)				
CIE x	CIE y	θ	a	b
0.4073	0.3917	54.00	0.0093	0.0041

MacAdam 3-step Ellipse (TU)				
CIE x	CIE y	θ	a	b
0.3818	0.3797	53.72	0.0094	0.0040

MacAdam 3-step Ellipse (RU)				
CIE x	CIE y	θ	a	b
0.3447	0.3553	59.62	0.0082	0.0035

MacAdam 3-step Ellipse (QU)				
CIE x	CIE y	θ	a	b
0.3287	0.3417	59.10	0.0075	0.0032

MacAdam 3-step Ellipse (PU)				
CIE x	CIE y	θ	a	b
0.3123	0.3282	58.57	0.0067	0.0029

Note:

Samsung maintains measurement tolerance of: $C_x, C_y = \pm 0.005$

3. Typical Characteristics Graphs

a) Spectrum Distribution ($I_f = 65 \text{ mA}$, $T_s = 25 \text{ }^\circ\text{C}$)

CCT: 2700 K (80 CRI)

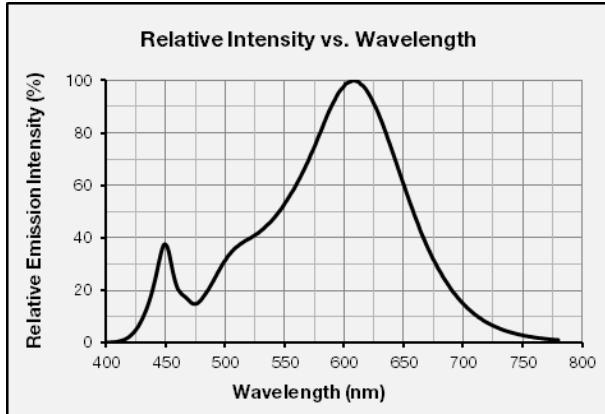

CCT: 3000 K (80 CRI)

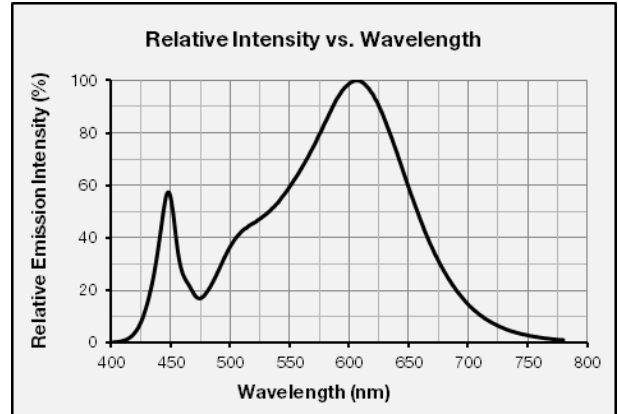

CCT: 3500 K (80 CRI)

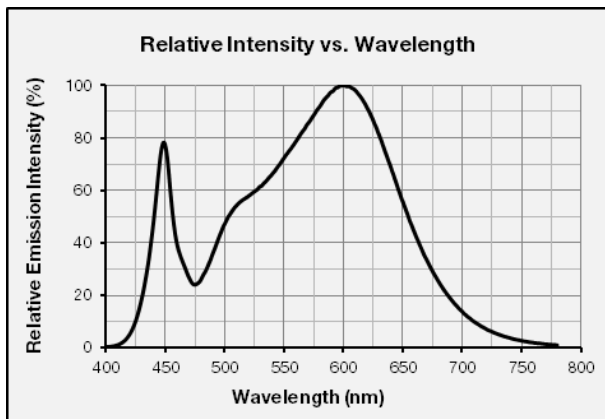

CCT: 4000 K (80 CRI)

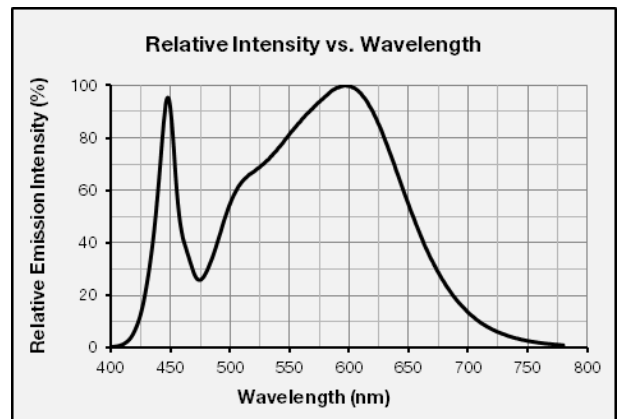

CCT: 5000 K (80 CRI)

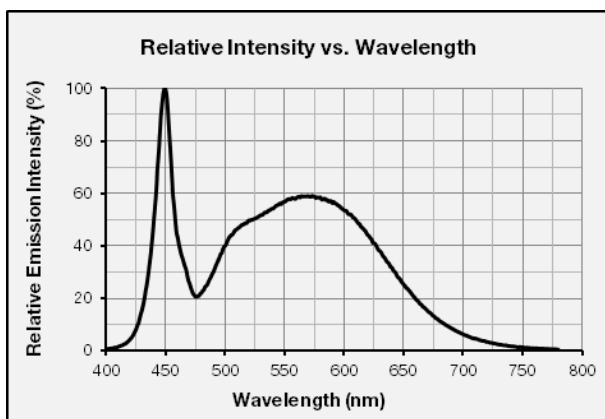

CCT: 5700 K (80 CRI)

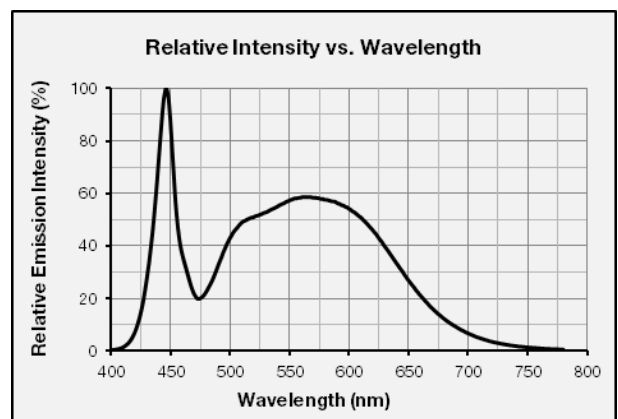

CCT: 6500 K (80 CRI)

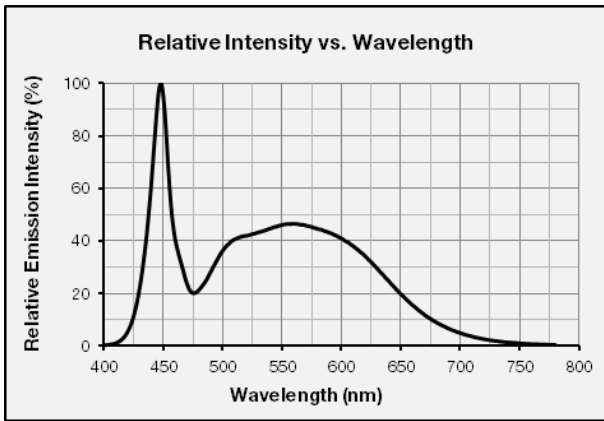

b) Forward Current Characteristics ($T_s = 25^\circ\text{C}$)

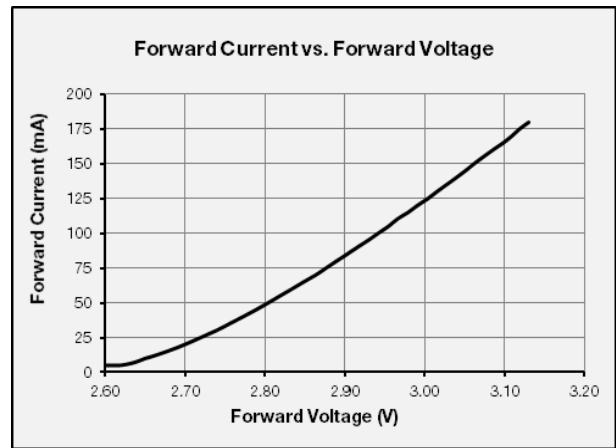
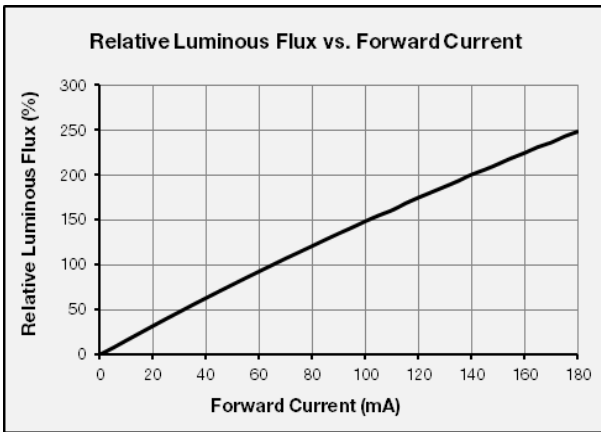

c) Temperature Characteristics ($I_f = 65\text{ mA}$)

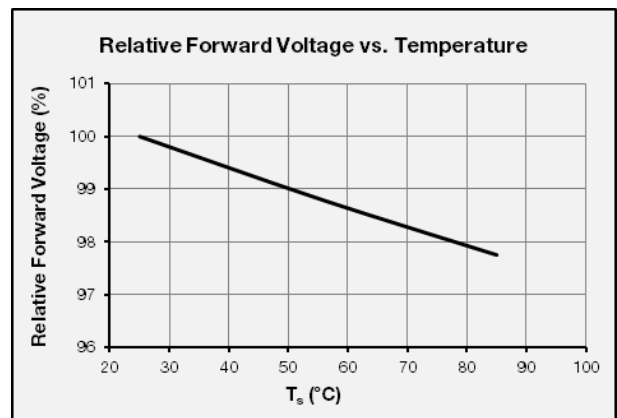
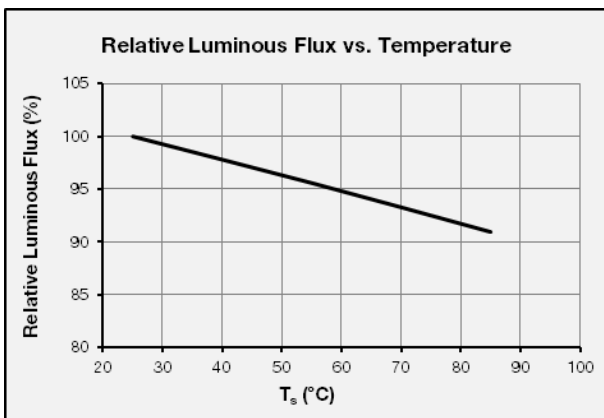

d) Color Shift Characteristics

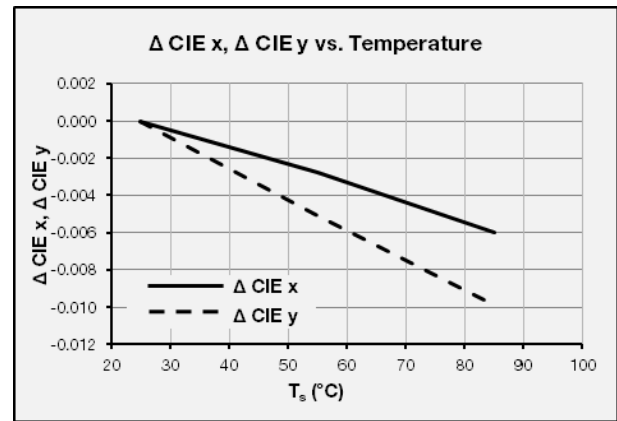
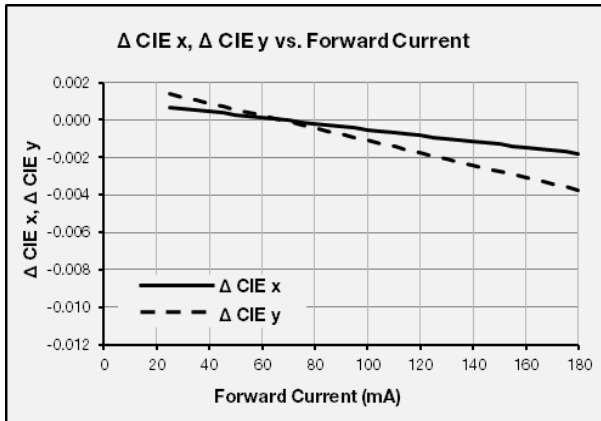
 $T_s = 25^\circ\text{C}$ $I_f = 65\text{ mA}$ 

e) Derating Curve

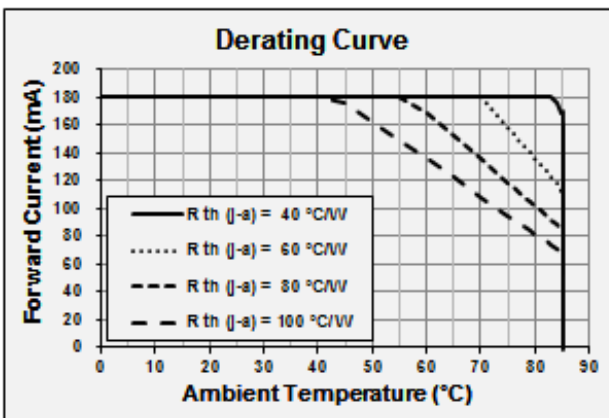
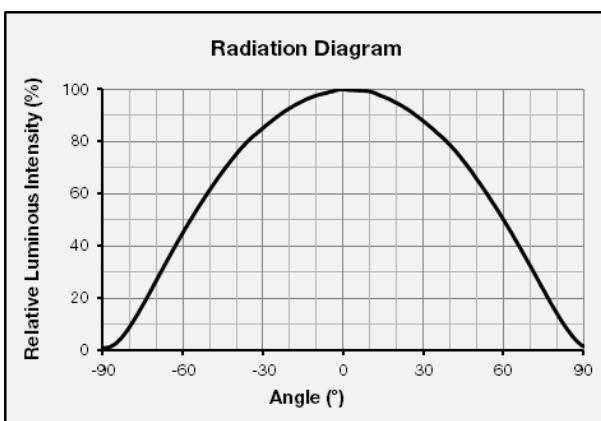
f) Beam Angle Characteristics ($I_f = 65\text{ mA}$, $T_s = 25^\circ\text{C}$)

5. Reliability Test Items & Conditions

a) Test Items

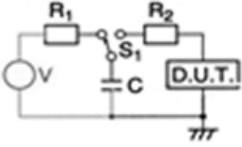
Test Item	Test Condition	Test Hour / Cycle	Sample No.	
Room Temperature Life Test	25 °C, DC 180 mA	1000 h	22	
High Temperature Life Test	85 °C, DC 180 mA	1000 h	22	
High Temperature Humidity Life Test	85 °C, 85 % RH, DC 180 mA	1000 h	22	
Low Temperature Life Test	-40 °C, DC 180 mA	1000 h	22	
Powered Temperature Cycle Test	-45 °C / 20 min ↔ 85 °C / 20 min, sweep 100 min cycle on/off: each 5 min, DC 180 mA	100 cycles	22	
Thermal Cycle	-45 °C / 15 min ↔ 125 °C / 15 min → Hot plate 180 °C	500 cycles	100	
High Temperature Storage	120 °C	1000 h	11	
Low Temperature Storage	-40 °C	1000 h	11	
ESD (HBM)		R ₁ : 10 MΩ R ₂ : 1.5 kΩ C: 100 pF V: ±5 kV	5 times	30
ESD (MM)				
Vibration Test	20~2000~20 Hz, 200 m/s ² , sweep 4 min X, Y, Z 3 direction, each 1 cycle	4 cycles	11	
Mechanical Shock Test	1500 g, 0.5 ms 3 shocks each X-Y-Z axis	5 cycles	11	

b) Criteria for Judging the Damage

Item	Symbol	Test Condition (T _s = 25 °C)	Limit	
			Min	Max
Forward Voltage	V _F	I _F = 65 mA	Init. Value * 0.9	Init. Value * 1.1
Luminous Flux	Φ _v	I _F = 65 mA	Init. Value * 0.7	Init. Value * 1.1

6. Soldering Conditions

a) Reflow Conditions (Pb free)

Reflow frequency: 2 times max.

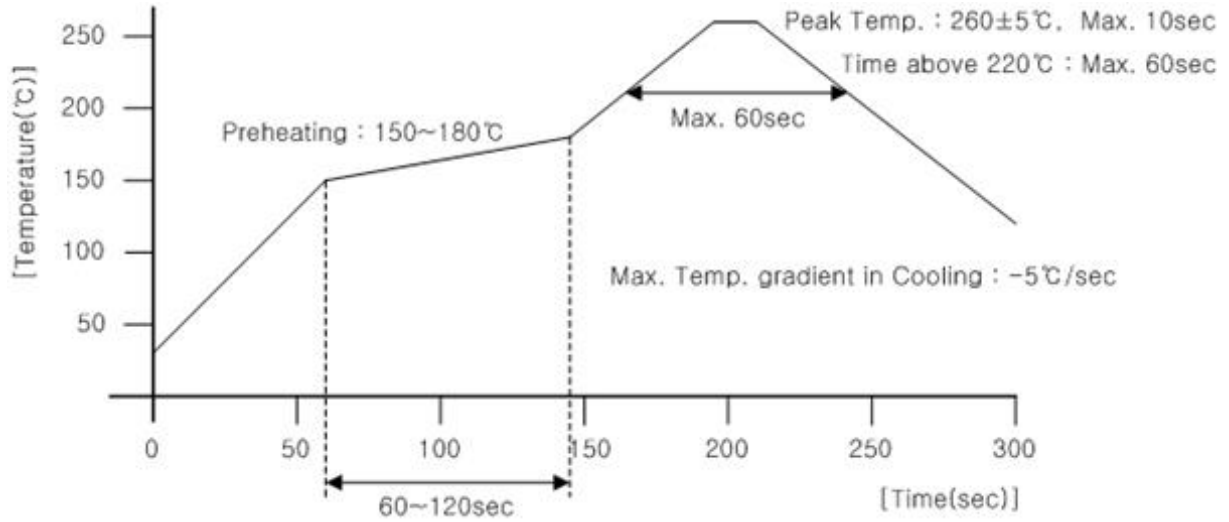

b) Manual Soldering Conditions

Not more than 5 seconds @ max. 300 °C, under soldering iron.

7. Tape & Reel

a) Taping Dimension

(unit: mm)

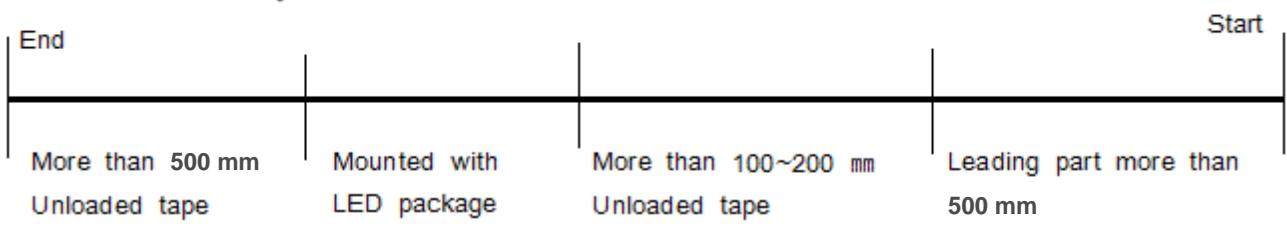
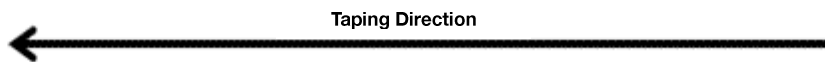
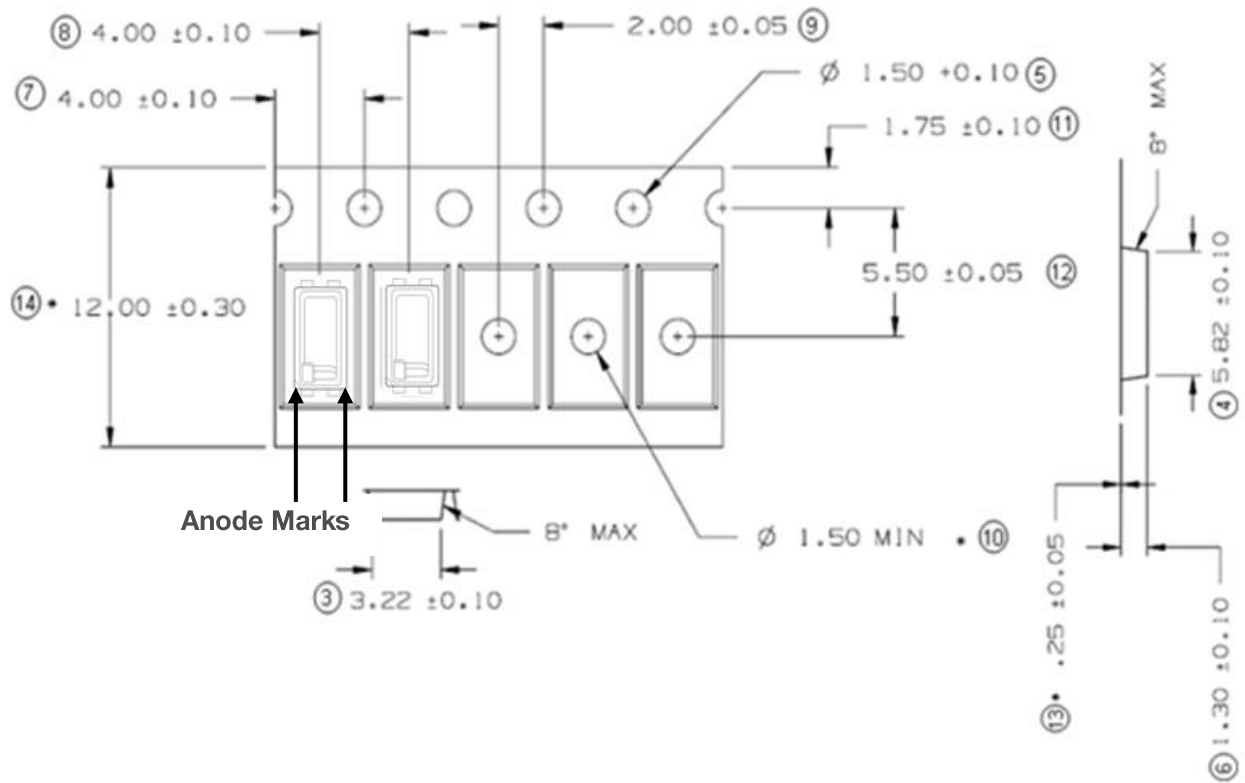

b-1) Reel Dimension (Max 2,500 pcs)

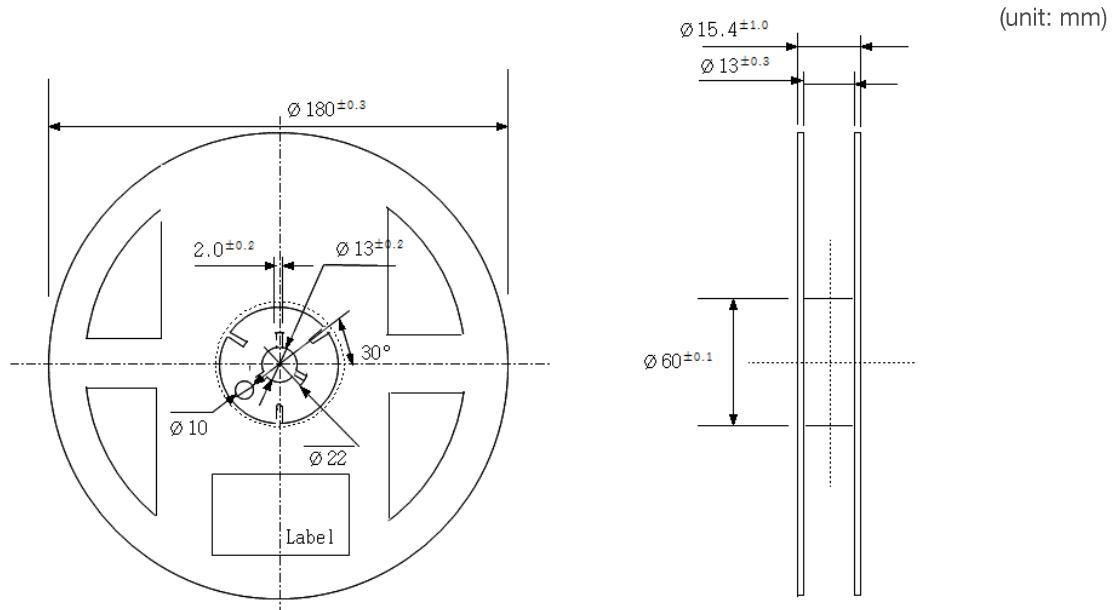

b-2) Reel Dimension (Max 10,000 pcs)

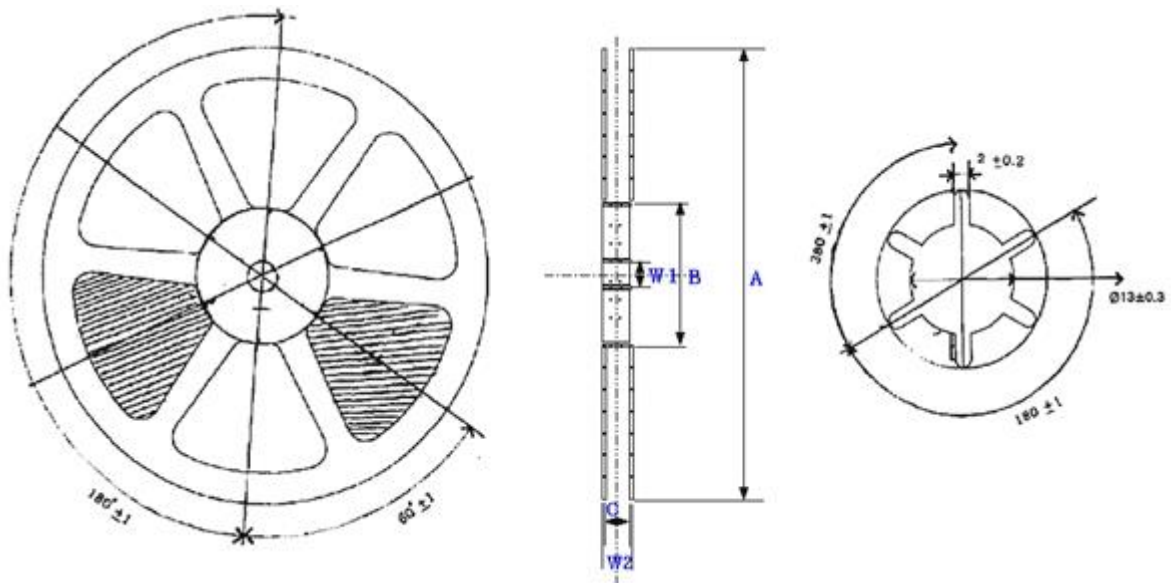

Symbol	A	B	C	W1	W2
Spec(mm)	Ø330±1	80±1	13±0.5	13±0.3	17.5±1

Notes:

- 1) Quantity: The quantity/reel is 2,500 or 10,000 pcs
- 2) Cumulative Tolerance: Cumulative tolerance / 10 pitches is ±0.2 mm
- 3) Adhesion Strength of Cover Tape: Adhesion strength is 0.1-0.7 N when the cover tape is turned off from the carrier tape at 10° angle to the carrier tape
- 4) Packaging: P/N, Manufacturing data code no. and quantity are indicated on the aluminum packing bag

8. Label Structure

a) Label Structure

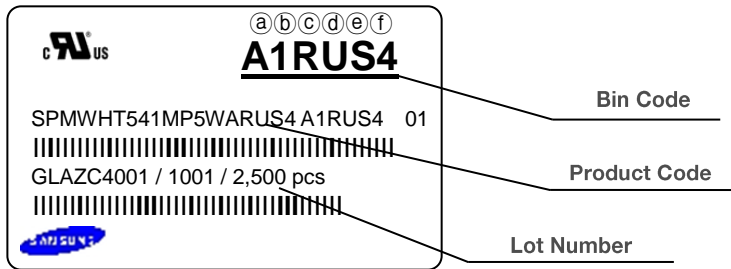

Note: Denoted bin code and product code above is only an example (see description on page 5)

Bin Code:

- ⒶⒷ: Forward Voltage bin (refer to page 8)
- ⒸⒹ: Chromaticity bin (refer to page 6)
- ⒺⒻ: Luminous Flux bin (refer to page 7)

b) Lot Number

The lot number is composed of the following characters:

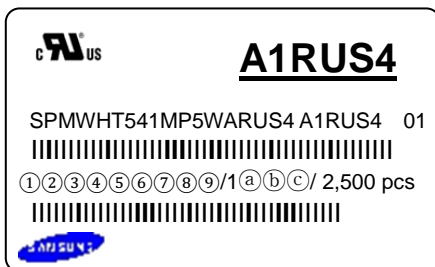

①②③④⑤⑥⑦⑧⑨ / 1ⒶⒷⒸ / 2,500 pcs

- ① : Production site (S: Giheung, Korea, G: Tianjin, China)
- ② : L (LED)
- ③ : Product state (A: Normal, B: Bulk, C: First Production, R: Reproduction, S: Sample)
- ④ : Year (Z: 2015, A: 2016, B: 2017...)
- ⑤ : Month (1~9, A, B, C)
- ⑥⑦⑧⑨ : Day (1~9, A, B~V)
- ⒶⒷⒸ : Product serial number (001 ~ 999)

9. Packing Structure

a-1) Packing Process (The quantity of PKG on the Reel to be Max 2,500pcs)

Reel

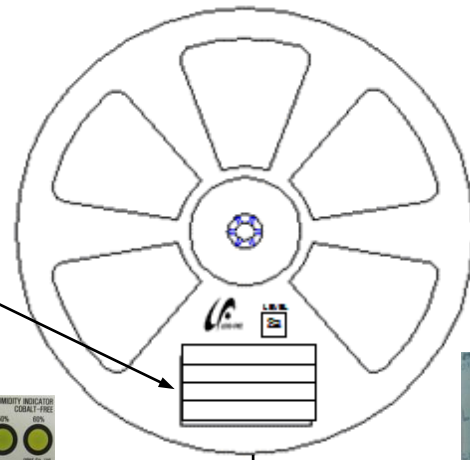
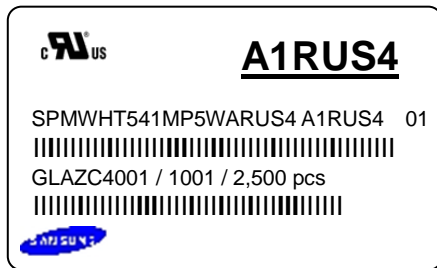

Aluminum Vinyl Packing Bag

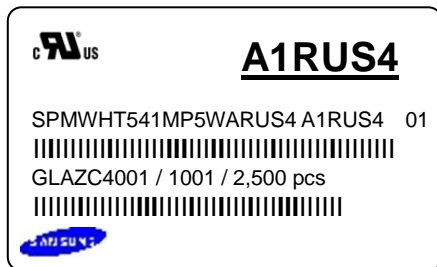

Outer Box

Material: Paper (SW3B(B))

Type	Size (mm)			Note
	L	W	H	
7 inch L	245 ± 5	220 ± 5	182 ± 5	Up to 10 reels
7 inch S	245 ± 5	220 ± 5	86 ± 5	Up to 5 reels

① Side Label

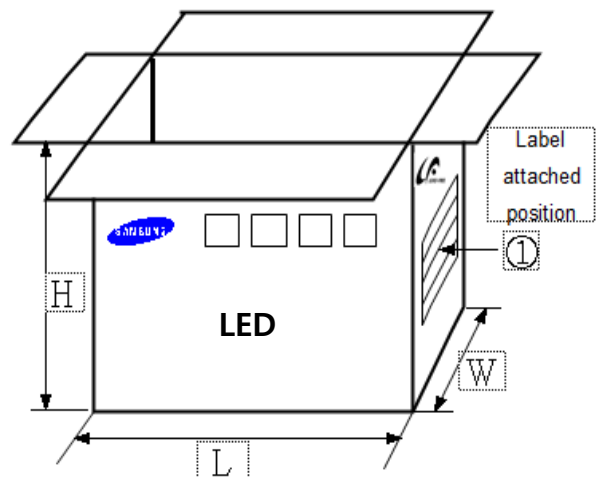
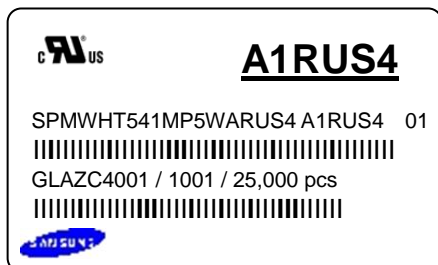

a-2) Packing Process (The quantity of PKG on the Reel to be Max 10,000pcs)

Reel

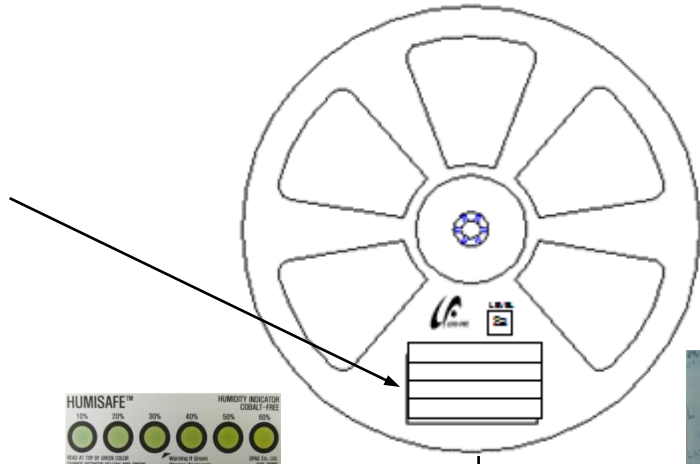
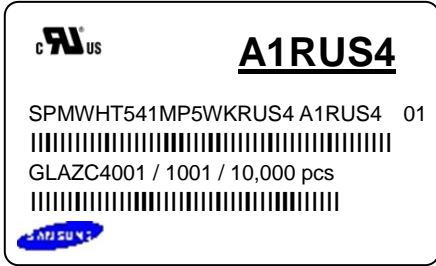

Aluminum Vinyl Packing Bag

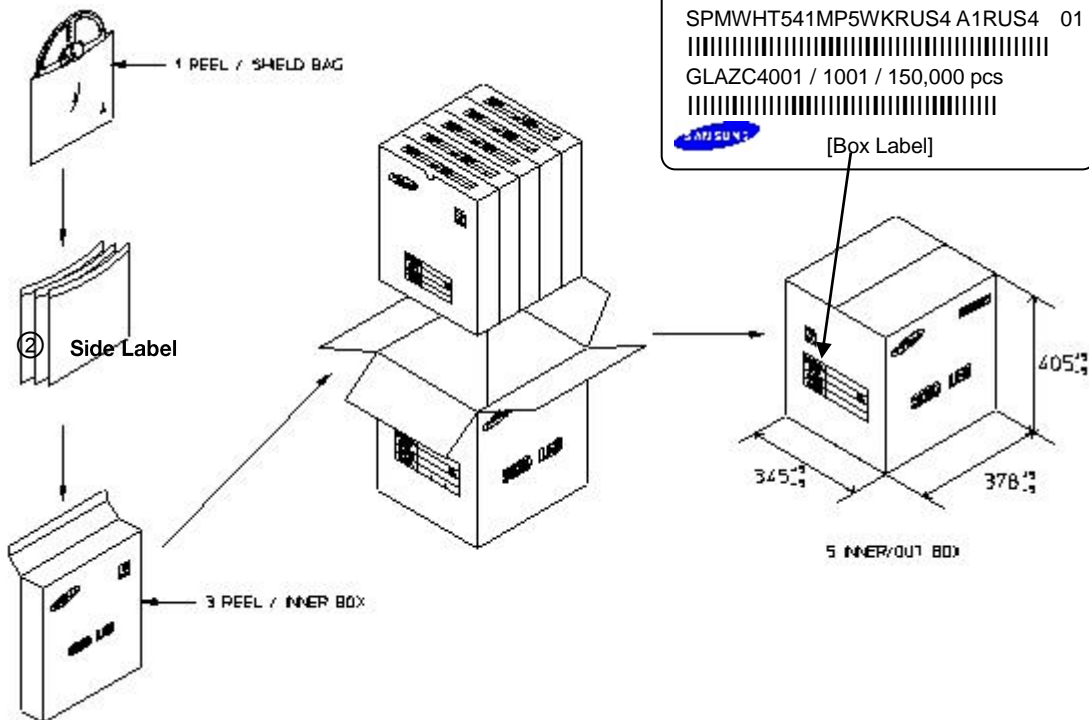
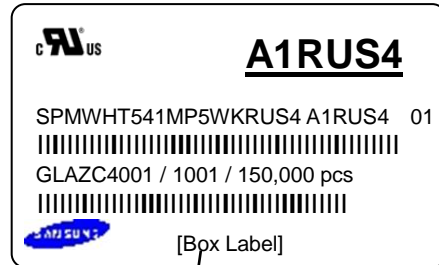
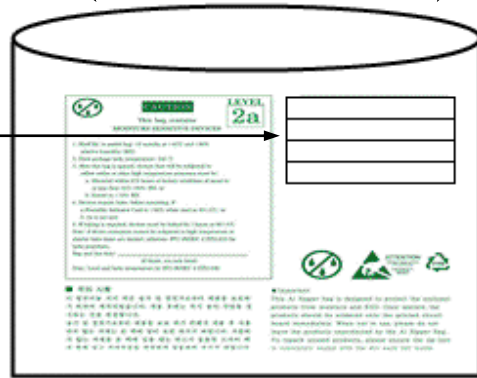
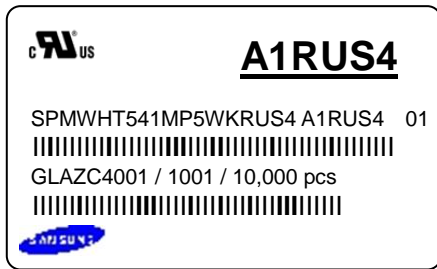

c) Aluminum Vinyl Packing Bag



CAUTION

This bag contains
MOISTURE SENSITIVE DEVICES

LEVEL



2a

A1RUS4

SPMWHT541MP5WARUS4 A1RUS4 01

GLAZC4001 / 1001 / 2,500 pcs



주의 사항

이 알루미늄 지퍼 백은 습기 및 정전기로부터 제품을 보호하기 위하여 제작되었습니다. 개봉 후에는 즉시 솔더 작업을 실시하는 것을 권장합니다.

습기 및 정전기로부터 제품을 보호 하기 위해서 개봉 후 사용하지 않는 자재는 본 팩에 넣어 보관 하시기 바랍니다. 사용하지 않는 자재를 본 팩에 넣을 때는 반드시 동봉된 드라이 팩과 함께 넣고 지퍼부분을 완전하게 밀봉하여 주시기 바랍니다.

Important

This Al Zipper bag is designed to protect the enclosed products from moisture and ESD. Once opened, the products should be soldered onto the printed circuit board immediately. When not in use, please do not leave the products unprotected by the Al Zipper Bag. To repack unused products., please ensure the zip-lock is completely sealed with the dry pack left inside.

d) Silica Gel & Humidity Indicator Card inside Aluminum Vinyl Bag



HUMISAFE™

HUMIDITY INDICATOR COBALT-FREE

10%	20%	30%	40%	50%	60%
					

READ AT TOP OF GREEN COLOR
CHANGE BETWEEN YELLOW AND GREEN

Warning If Green Change Desiccant

GP&E Co., Ltd.
6CF-60NS

10. Precautions in Handling & Use

- 1) For over-current protection, users are recommended to apply resistors connected in series with the LEDs to mitigate sudden change of the forward current caused by shift of forward voltage.
- 2) This device should not be used in any type of fluid such as water, oil, organic solvent, etc. When cleaning is required, IPA is recommended as the cleaning agent. Some solvent-based cleaning agent may damage the silicone resins used in the device.
- 3) When the device is in operation, the forward current should be carefully determined considering the maximum ambient temperature and corresponding junction temperature.
- 4) LEDs must be stored in a clean environment. If the LEDs are to be stored for three months or more after being shipped from Samsung, they should be packed with a nitrogen-filled container (shelf life of sealed bags is 12 months at temperature 0~40 °C, 0~90 % RH).
- 5) After storage bag is opened, device subjected to soldering, solder reflow, or other high temperature processes must be:
 - a. Mounted within 672 hours (28 days) at an assembly line with a condition of no more than 30 °C / 60 % RH, or
 - b. Stored at <10 % RH
- 6) Repack unused devices with anti-moisture packing, fold to close any opening and then store in a dry place.
- 7) Devices require baking before mounting, if humidity card reading is >60 % at 23 ± 5 °C.
- 8) Devices must be baked for 10~24 hours at 60 ± 5 °C, if baking is required.
- 9) The LEDs are sensitive to the static electricity and surge current. It is recommended to use a wrist band or anti-electrostatic glove when handling the LEDs. If voltage exceeding the absolute maximum rating is applied to LEDs, it may cause damage or even destruction to LED devices. Damaged LEDs may show some unusual characteristics such as increase in leakage current, lowered turn-on voltage, or abnormal lighting of LEDs at low current.
- 10) VOCs (Volatile Organic Compounds) can be generated from adhesives, flux, hardener or organic additives used in luminaires (fixtures). Transparent LED silicone encapsulant is permeable to those chemicals and they may lead to a discoloration of encapsulant when they exposed to heat or light. This phenomenon can cause a significant loss of light emitted (output) from the luminaires. In order to prevent these problems, we recommend users to know the physical properties of materials used in luminaires and they must be carefully selected.
- 11) Risk of sulfurization (or tarnishing)
 The LED from Samsung uses a silver-plated lead frame and its surface color may change to black (or dark colored) when it is exposed to sulfur (S), chlorine (Cl) or other halogen compound. Sulfurization of lead frame may cause intensity degradation, change of chromaticity coordinates and, in extreme cases, open circuit. It requires caution. Due to possible sulfurization of lead frame, LED should not be used and stored together with oxidizing substances made of materials such as rubber, plain paper, lead solder cream, etc.

Legal and additional information.

[About Samsung Electronics Co., Ltd.](#)

Samsung Electronics Co., Ltd. is a global leader in technology, opening new possibilities for people everywhere. Through relentless innovation and discovery, we are transforming the worlds of TVs, smartphones, tablets, PCs, cameras, home appliances, printers, LTE systems, medical devices, semiconductors and LED solutions. We employ 286,000 people across 80 countries with annual sales of US\$216.7 billion. To discover more, please visit www.samsungled.com.

Copyright © 2015 Samsung Electronics Co., Ltd. All rights reserved.
Samsung is a registered trademark of Samsung Electronics Co., Ltd.
Specifications and designs are subject to change without notice. Non-metric weights and measurements are approximate. All data were deemed correct at time of creation. Samsung is not liable for errors or omissions. All brand, product, service names and logos are trademarks and/or registered trademarks of their respective owners and are hereby recognized and acknowledged.

Samsung Electronics Co., Ltd.
95, Samsung 2-ro
Giheung-gu
Yongin-si, Gyeonggi-do, 446-711
KOREA

www.samsungled.com



Looking for pricing, stock, or lifecycle information?

Click below to explore more details on WIN SOURCE:

-  [View SPMWHT541MP5WAUMS5 on WIN SOURCE](#)
-  [Samsung Information](#)

Optimize Your Supply Chain with WIN SOURCE Solutions

-  Global Sourcing Solution
-  Obsolete Management
-  Cost Control Management
-  Shortage Management
-  Alternative Solution
-  Excess Inventory Management