



**THE DATASHEET OF
SPMWHT541MP5WASMS5**



Middle Power LED Series
5630

LM561B Plus



Improved efficacy and performance of LM561B to provide better solution



Features & Benefits

- 0.3 W class middle power LED
- Mold resin for high reliability
- Standard form factor for design flexibility (5.6 × 3.0 mm)

Table of Contents

| | | | |
|-----|-------------------------------------|-------|----|
| 1. | Characteristics | ----- | 3 |
| 2. | Product Code Information | ----- | 5 |
| 3. | Typical Characteristics Graphs | ----- | 14 |
| 4. | Outline Drawing & Dimension | ----- | 16 |
| 5. | Reliability Test Items & Conditions | ----- | 17 |
| 6. | Soldering Conditions | ----- | 18 |
| 7. | Tape & Reel | ----- | 19 |
| 8. | Label Structure | ----- | 21 |
| 9. | Packing Structure | ----- | 22 |
| 10. | Precautions in Handling & Use | ----- | 27 |

1. Characteristics

a) Absolute Maximum Rating

| Item | Symbol | Rating | Unit | Condition |
|---------------------------------|-----------|------------|---------|------------------------------|
| Ambient / Operating Temperature | T_a | -40 ~ +85 | °C | - |
| Storage Temperature | T_{stg} | -40 ~ +120 | °C | - |
| LED Junction Temperature | T_j | 110 | °C | - |
| Forward Current | I_F | 180 | mA | - |
| Peak Pulsed Forward Current | I_{fp} | 300 | mA | Duty 1/10, pulse width 10 ms |
| Assembly Process Temperature | - | 260 <10 | °C s | - |
| ESD (HBM) | - | ±5 | kV | - |

b) Electro-optical Characteristics (I_F = 65 mA, T_s = 25 °C)

| Item | Unit | CRI (R _a) Min. | Nominal CCT (K) | Rank | Bin | Min. | Typ. | Max. |
|--|------|-------------------------------|--------------------|------------|-----|------|------|------|
| Forward Voltage (V _F) | V | | | WA (WK) | AZ | 2.7 | - | 2.8 |
| | | | | | A1 | 2.8 | - | 2.9 |
| | | | | | A2 | 2.9 | - | 3.0 |
| | | | | | A3 | 3.0 | - | 3.1 |
| | | | | | A4 | 3.1 | - | 3.2 |
| Luminous Flux (Φ _v) | lm | 80 | 5000 | | S4 | 33.0 | - | 35.0 |
| | | | | | S5 | 35.0 | - | 37.0 |
| Reverse Voltage (@ 5 mA) | V | | | | | 0.7 | - | 1.2 |
| Color Rendering Index (R _a) | - | | | 5 | | 80 | - | - |
| Special CRI (R9) | - | | | | | 0 | - | - |
| Thermal Resistance (junction to solder point) | °C/W | | | | | - | 14 | 20 |
| Beam Angle | ° | | | | | - | 120 | - |

Note:

Samsung maintains measurement tolerance of: forward voltage = ±0.1 V, luminous flux = ±5 %, CRI = ±3, R9 = ±6.5

2. Product Code Information

| | | | | | | | | | | | | | | | | | |
|---|---|---|---|---|---|---|---|---|----|----|----|----|----|----|----|----|----|
| 1 | 2 | 3 | 4 | 5 | 6 | 7 | 8 | 9 | 10 | 11 | 12 | 13 | 14 | 15 | 16 | 17 | 18 |
| S | P | M | W | H | T | 5 | 4 | 1 | M | P | 5 | W | K | S | K | S | 5 |

| Digit | PKG Information | Code | Specification |
|-------|------------------------------|-------------------------------------|--|
| 1 2 3 | Samsung Package Middle Power | SPM | |
| 4 5 | Color | WH | White |
| 6 | Product Version | T | |
| 7 8 9 | Form Factor | 541 | 5.6 x 3.0 x 0.7 mm; 4 pads; |
| 10 | Sorting Current (mA) | M | 65 mA |
| 11 | Chromaticity Coordinates | P | |
| 12 | CRI | 5 | Min. 80 |
| 13 14 | Forward Voltage (V) | WA WK | 2.7~3.2V (2,500 pcs/Reel) 2.7~3.2V (10,000 pcs/Reel) |
| 15 16 | CCT (K) | S★ | 5000 Bin Code: R6, R7, R8, S5, RA, RB, RC, S9, RE, RF, RG, SD, RU, RV, RW, ST ★ : "0" (Whole bin) "M" (Quarter bin), "N"(N Kitting), "K" (K Kitting), "G" (G Kitting) |
| 17 18 | Luminous Flux | S0 S4 S5 | Bin Code: S4 S5 |

a) Luminous Flux Bins($I_F = 65 \text{ mA}$, $T_s = 25^\circ\text{C}$)

| CRI (R_a) Min. | Nominal CCT (K) | Product Code | Flux Bin | Flux Range (Φ_v , lm) |
|-----------------------|--------------------|--------------------|----------|--------------------------------|
| 80 | 5000 | SPMWHT541MP5W◆S☆S4 | S4 | 33.0 ~ 35.0 |
| | | SPMWHT541MP5W◆S☆S5 | S5 | 35.0 ~ 37.0 |

Note:

"◆" can be "A" (2,500pcs) or "K" (10,000pcs) of reel taping

"☆" can be "0" (Whole bin), "M" (Quarter bin), "N"(N Kitting), "K" (K Kitting) or "G" (G Kitting) of the color binning

b) Kitting rule

1) K Kitting Concept

1. Under agreement between customer and SAMSUNG ELECTRONICS, SAMSUNG can supply kitting bin (VF, Color, Im).
2. A forward voltage (VF) of kitting bin is combined by a pair of same VF rank such as (A1+A1), (A2+A2), (A3+A3), (A4+A4) or (AZ+AZ).
3. A Chromaticity Coordinates of kitting bin is mixed by kitting procedure.(below kitting simulation)

[Kitting example]

| | | | |
|-----------------------------|----------------|----------------|-----------------|
| RU _Y | RV | RW | Z _{ST} |
| RE | RF | RG | SD |
| RA | RB | RC | S ₉ |
| R ₆ ^W | R ₇ | R ₈ | X _{S5} |

[Binning Information]

| | Bin #1 | Bin #2 | Priority |
|-----|--------|--------|----------|
| VF | AZ | AZ | |
| | A1 | A1 | |
| | A2 | A2 | |
| | A3 | A3 | |
| | A4 | A4 | |
| CIE | W | Z | |
| | V | V | |
| | X | Y | |
| IV | S4 | S4 | S4↑ |
| | S5 | S5 | S5↑ |

※ Each of V,W,X,Y and Z can be one bin without details division.

2) N Kitting Concept

1. Under agreement between customer and SAMSUNG ELECTRONICS, SAMSUNG can supply kitting bin (VF, Color, Im).
2. A forward voltage (VF) of kitting bin is combined by a pair of same VF rank such as (A1+A1), (A2+A2), (A3+A3), (A4+A4) or (AZ+AZ).
3. A Chromaticity Coordinates of kitting bin is mixed by kitting procedure.(below kitting simulation)

[Kitting example]

| | | | |
|----|----|----|----|
| RU | RV | RW | ST |
| RE | RF | RG | SD |
| RA | RB | RC | S9 |
| R6 | R7 | R8 | S5 |

[Binning Information]

| | Bin #1 | Bin #2 | Priority |
|-----|--------|--------|----------|
| VF | AZ | AZ | |
| | A1 | A1 | |
| | A2 | A2 | |
| | A3 | A3 | |
| | A4 | A4 | |
| CIE | B | G | |
| | C | F | |
| IV | S4 | S4 | S4↑ |
| | S5 | S5 | S5↑ |

. ※ Each of V,W,X,Y and Z can be one bin without details division.

3) G Kitting Concept

1. Under agreement between customer and SAMSUNG ELECTRONICS, SAMSUNG can supply kitting bin (VF, Color, Im).
2. A forward voltage (VF) of kitting bin is combined by a pair of same VF rank such as (A1+A1), (A2+A2), (A3+A3), (A4+A4) or (AZ+AZ).
3. A Chromaticity Coordinates of kitting bin is mixed by kitting procedure.(below kitting simulation)

[Kitting example]

| | | | |
|----|----|----|----|
| RU | RV | RW | ST |
| RE | RF | RG | SD |
| RA | RB | RC | S9 |
| R6 | R7 | R8 | S5 |

[Binning Information]

| | Bin #1 | Bin #2 | Priority |
|-----|--------|--------|----------|
| VF | AZ | AZ | |
| | A1 | A1 | |
| | A2 | A2 | |
| | A3 | A3 | |
| | A4 | A4 | |
| CIE | R6 | ST | |
| | R7 | RW | |
| | R8 | RV | |
| | S5 | RU | |
| | RA | SD | |
| | RB | RG | |
| | RC | RF | |
| | S9 | RE | |
| IV | S4 | S4 | S4↑ |
| | S5 | S5 | S5↑ |

※ Each of V,W,X,Y and Z can be one bin without details division.

c) Color Bins ($I_f = 65 \text{ mA}$, $T_s = 25 \text{ }^\circ\text{C}$)

| CRI (R_a) Min. | Nominal CCT (K) | Product Code | Color Rank | Chromaticity Bins |
|-----------------------|--------------------|--------------------|---------------------|---|
| 80 | 5000 | SPMWHT541MP5W◆S0S★ | S0 (Whole bin) | R6, R7, R8, S5, RA, RB, RC, S9, RE, RF, RG, SD, RU, RV, RW, ST |
| | | SPMWHT541MP5W◆SGS★ | SG (S Kitting) | |
| | | SPMWHT541MP5W◆SMS★ | SM (Quarter bin) | RB, RC, RF, RG |
| | | SPMWHT541MP5W◆SKS★ | SK (K Kitting) | SV, SW, SX, SY, SZ |
| | | SPMWHT541MP5W◆SNS★ | SN (N Kitting) | RB, RC, RF, RG |

Note:

"◆" can be "A" (2,500pcs) or "K" (10,000pcs) of reel taping

"★" can be "S4" or "S5" of luminous flux bin

d) Voltage Bins ($I_f = 65 \text{ mA}$, $T_s = 25 \text{ }^\circ\text{C}$)

| CRI (R_a) Min. | Nominal CCT (K) | Product Code | Voltage Rank | Voltage Bin | Voltage Range (V) |
|-----------------------|--------------------|--------------|--------------|-------------|----------------------|
| - | - | - | WA (WK) | AZ | 2.7 ~ 2.8 |
| | | | | A1 | 2.8 ~ 2.9 |
| | | | | A2 | 2.9 ~ 3.0 |
| | | | | A3 | 3.0 ~ 3.1 |
| | | | | A4 | 3.1 ~ 3.2 |

e) Chromaticity Region & Coordinates ($I_F = 65 \text{ mA}$, $T_s = 25^\circ\text{C}$)

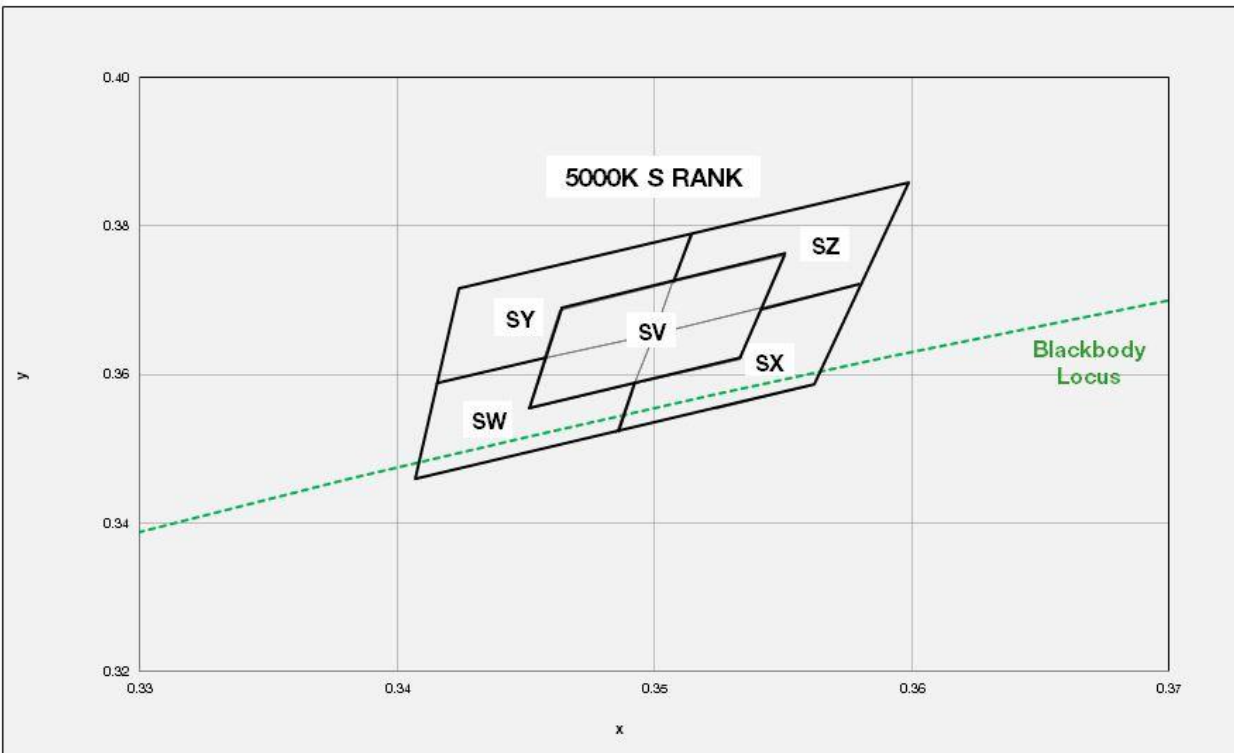

e) Chromaticity Region & Coordinates ($I_f = 65 \text{ mA}$, $T_s = 25 \text{ }^\circ\text{C}$)

| Region | CIE x | CIE y | Region | CIE x | CIE y |
|----------------|--------|--------|--------|--------|--------|
| S rank (5000K) | | | | | |
| R6 | 0.3407 | 0.346 | RE | 0.3415 | 0.3587 |
| | 0.3411 | 0.3522 | | 0.342 | 0.3652 |
| | 0.3451 | 0.3554 | | 0.3463 | 0.3687 |
| | 0.3446 | 0.3491 | | 0.3457 | 0.3621 |
| R7 | 0.3446 | 0.3491 | RF | 0.3457 | 0.3621 |
| | 0.3451 | 0.3554 | | 0.3463 | 0.3687 |
| | 0.3492 | 0.3587 | | 0.3507 | 0.3724 |
| | 0.3485 | 0.3522 | | 0.35 | 0.3655 |
| R8 | 0.3485 | 0.3522 | RG | 0.35 | 0.3655 |
| | 0.3492 | 0.3587 | | 0.3507 | 0.3724 |
| | 0.3533 | 0.362 | | 0.3551 | 0.376 |
| | 0.3524 | 0.3554 | | 0.3542 | 0.369 |
| S5 | 0.3524 | 0.3554 | SD | 0.3542 | 0.369 |
| | 0.3533 | 0.362 | | 0.3551 | 0.376 |
| | 0.3571 | 0.3655 | | 0.359 | 0.3792 |
| | 0.3562 | 0.3586 | | 0.358 | 0.3723 |
| RA | 0.3415 | 0.3587 | RU | 0.342 | 0.3652 |
| | 0.3411 | 0.3522 | | 0.3424 | 0.3715 |
| | 0.3451 | 0.3554 | | 0.3469 | 0.3752 |
| | 0.3457 | 0.3622 | | 0.3463 | 0.3687 |
| RB | 0.3451 | 0.3554 | RV | 0.3463 | 0.3687 |
| | 0.3457 | 0.3621 | | 0.3469 | 0.3752 |
| | 0.35 | 0.3655 | | 0.3515 | 0.379 |
| | 0.3492 | 0.3587 | | 0.3507 | 0.3724 |
| RC | 0.3492 | 0.3587 | RW | 0.3507 | 0.3724 |
| | 0.35 | 0.3655 | | 0.3515 | 0.379 |
| | 0.3542 | 0.369 | | 0.356 | 0.3827 |
| | 0.3533 | 0.362 | | 0.3551 | 0.376 |
| S9 | 0.3533 | 0.362 | ST | 0.3551 | 0.376 |
| | 0.3542 | 0.369 | | 0.356 | 0.3827 |
| | 0.358 | 0.3723 | | 0.3599 | 0.3859 |
| | 0.3571 | 0.3655 | | 0.359 | 0.3792 |

f) Kitting Chromaticity Region & Coordinates

| Region | CIE x | CIE y | Region | CIE x | CIE y |
|------------------------|--------|--------|--------|--------|--------|
| S rank (5000 K) | | | | | |
| SV | 0.3451 | 0.3554 | SY | 0.3415 | 0.3588 |
| | 0.3463 | 0.3687 | | 0.35 | 0.3655 |
| | 0.3551 | 0.376 | | 0.3515 | 0.379 |
| | 0.3533 | 0.362 | | 0.3424 | 0.3715 |
| SW | 0.3407 | 0.346 | SZ | 0.358 | 0.3723 |
| | 0.3415 | 0.3588 | | 0.35 | 0.3655 |
| | 0.35 | 0.3655 | | 0.3515 | 0.379 |
| | 0.3485 | 0.3524 | | 0.3599 | 0.3859 |
| SX | 0.3485 | 0.3524 | | | |
| | 0.35 | 0.3655 | | | |
| | 0.358 | 0.3723 | | | |
| | 0.3562 | 0.3586 | | | |

Note:

Samsung maintains measurement tolerance of: $C_x, C_y = \pm 0.005$

3. Typical Characteristics Graphs

a) Spectrum Distribution ($I_f = 65 \text{ mA}$, $T_s = 25 \text{ }^\circ\text{C}$)

CCT: 5000 K (80 CRI)

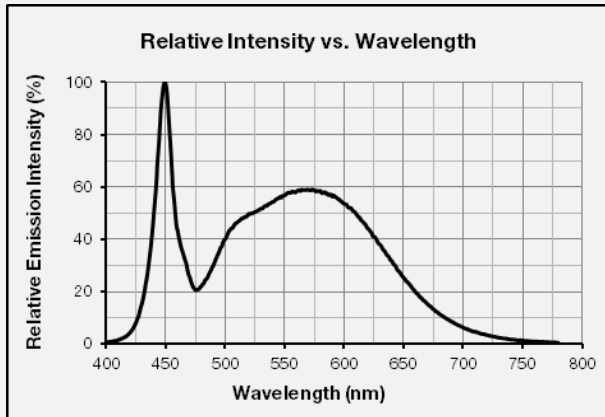

b) Forward Current Characteristics ($T_s = 25 \text{ }^\circ\text{C}$)

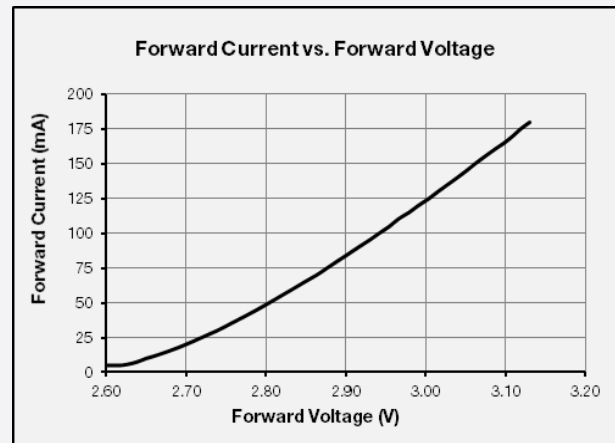
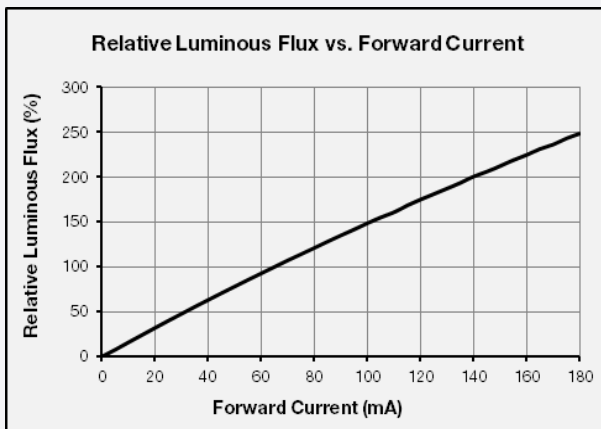

c) Temperature Characteristics ($I_f = 65 \text{ mA}$)

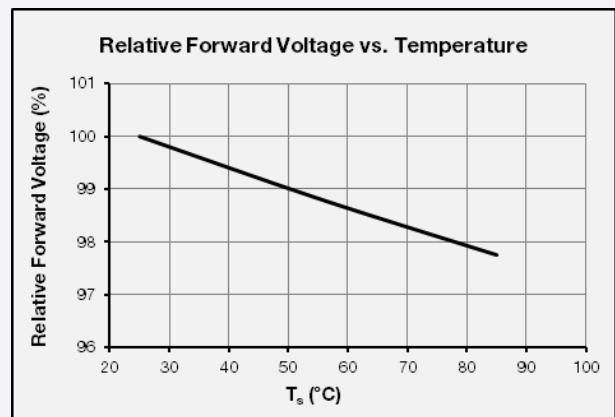
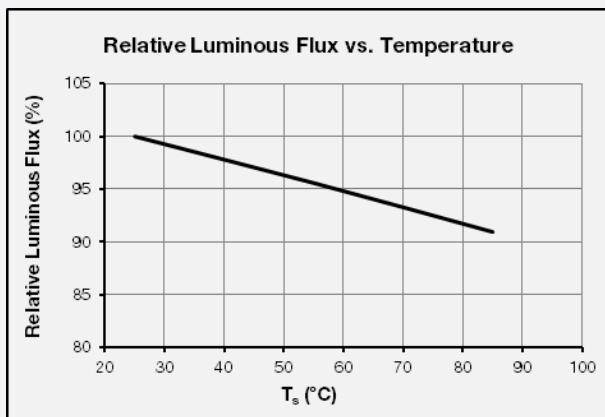

d) Color Shift Characteristics

$T_s = 25^\circ\text{C}$

$I_F = 65\text{ mA}$

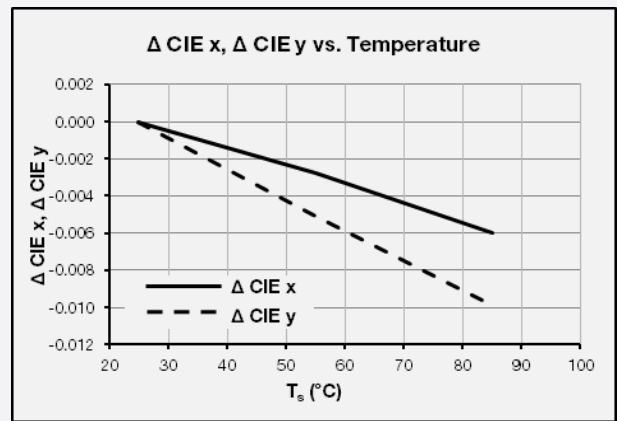
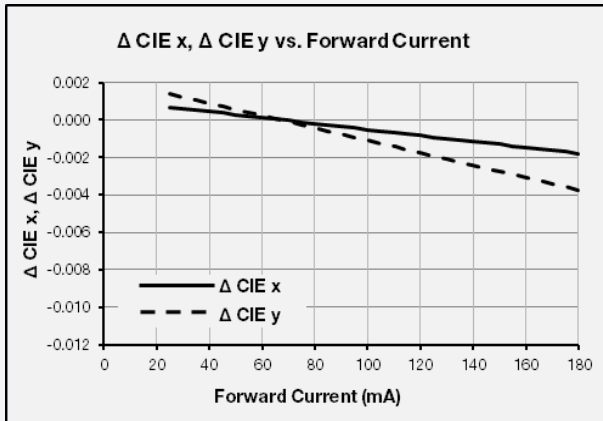

e) Derating Curve

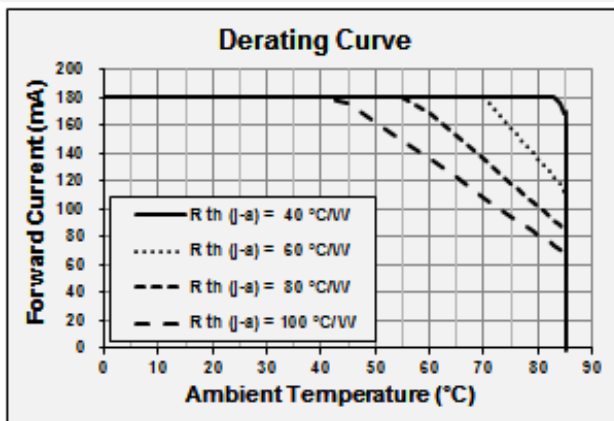

f) Beam Angle Characteristics ($I_F = 65\text{ mA}$, $T_s = 25^\circ\text{C}$)

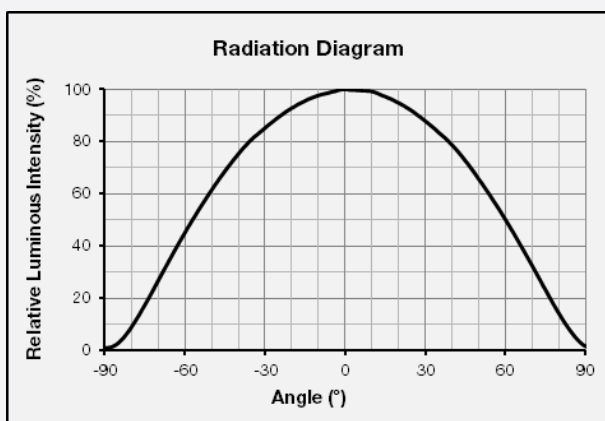

5. Reliability Test Items & Conditions

a) Test Items

| Test Item | Test Condition | Test Hour / Cycle | Sample No. | |
|-------------------------------------|--|--|------------|----|
| Room Temperature Life Test | 25 °C, DC 180 mA | 1000 h | 22 | |
| High Temperature Life Test | 85 °C, DC 180 mA | 1000 h | 22 | |
| High Temperature Humidity Life Test | 85 °C, 85 % RH, DC 180 mA | 1000 h | 22 | |
| Low Temperature Life Test | -40 °C, DC 180 mA | 1000 h | 22 | |
| Powered Temperature Cycle Test | -45 °C / 20 min ↔ 85 °C / 20 min, sweep 100 min cycle on/off: each 5 min, DC 180 mA | 100 cycles | 22 | |
| Thermal Cycle | -45 °C / 15 min ↔ 125 °C / 15 min → Hot plate 180 °C | 500 cycles | 100 | |
| High Temperature Storage | 120 °C | 1000 h | 11 | |
| Low Temperature Storage | -40 °C | 1000 h | 11 | |
| ESD (HBM) | | R ₁ : 10 MΩ R ₂ : 1.5 kΩ C: 100 pF V: ±5 kV | 5 times | 30 |
| ESD (MM) | | | | |
| Vibration Test | 20~2000~20 Hz, 200 m/s ² , sweep 4 min X, Y, Z 3 direction, each 1 cycle | 4 cycles | 11 | |
| Mechanical Shock Test | 1500 g, 0.5 ms 3 shocks each X-Y-Z axis | 5 cycles | 11 | |

b) Criteria for Judging the Damage

| Item | Symbol | Test Condition (T _s = 25 °C) | Limit | |
|-----------------|----------------|--|-------------------|-------------------|
| | | | Min | Max |
| Forward Voltage | V _F | I _F = 65 mA | Init. Value * 0.9 | Init. Value * 1.1 |
| Luminous Flux | Φ _v | I _F = 65 mA | Init. Value * 0.7 | Init. Value * 1.1 |

6. Soldering Conditions

a) Reflow Conditions (Pb free)

Reflow frequency: 2 times max.



b) Manual Soldering Conditions

Not more than 5 seconds @ max. 300 °C, under soldering iron.

7. Tape & Reel

a) Taping Dimension

(unit: mm)

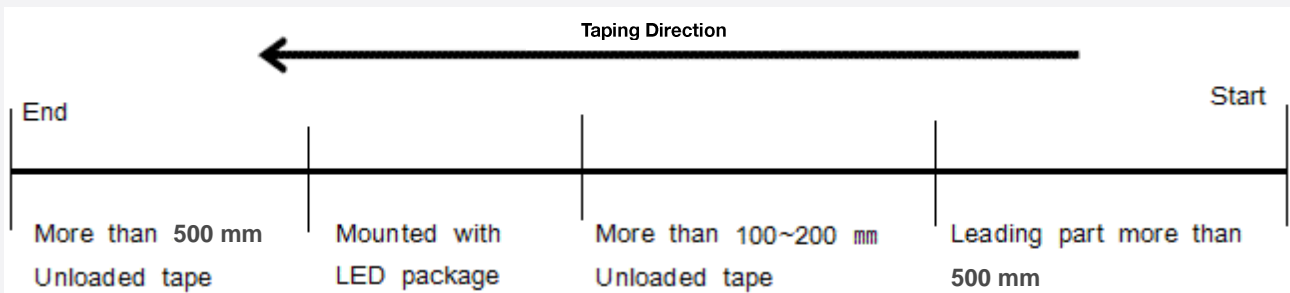

b-1) Reel Dimension (Max 2,500 pcs)

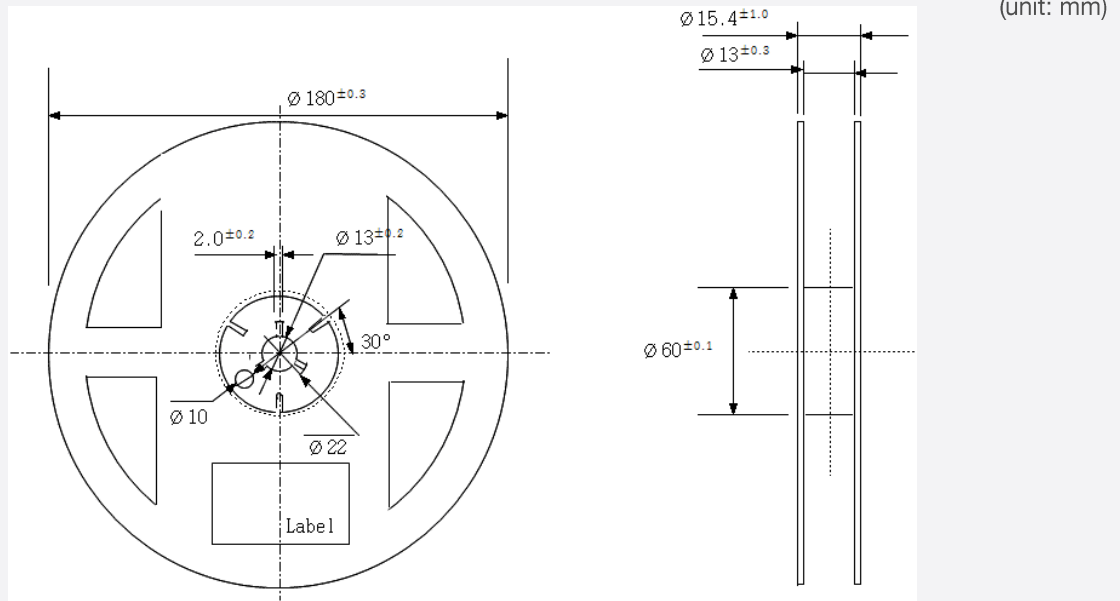

b-2) Reel Dimension (Max 10,000 pcs)



| Symbol | A | B | C | W1 | W2 |
|----------|--------|------|--------|--------|--------|
| Spec(mm) | Ø330±1 | 80±1 | 13±0.5 | 13±0.3 | 17.5±1 |

Notes:

- 1) Quantity: The quantity/reel is 2,500 or 10,000 pcs
- 2) Cumulative Tolerance: Cumulative tolerance / 10 pitches is ±0.2 mm
- 3) Adhesion Strength of Cover Tape: Adhesion strength is 0.1-0.7 N when the cover tape is turned off from the carrier tape at 10° angle to the carrier tape
- 4) Packaging: P/N, Manufacturing data code no. and quantity are indicated on the aluminum packing bag

8. Label Structure

a) Label Structure



Note: Denoted bin code and product code above is only an example (see description on page 5)

Bin Code:

- ⒶⒷ: Forward Voltage bin (refer to page 8)
- ⒸⒹ: Chromaticity bin (refer to page 10-13)
- ⒺⒻ: Luminous Flux bin (refer to page 8)

b) Lot Number

The lot number is composed of the following characters:



①②③④⑤⑥⑦⑧⑨ / 1ⒶⒷⒸ / 2,500 pcs

- ① : Production site (S: Giheung, Korea, G: Tianjin, China)
- ② : L (LED)
- ③ : Product state (A: Normal, B: Bulk, C: First Production, R: Reproduction, S: Sample)
- ④ : Year (Z: 2015, A: 2016, B: 2017...)
- ⑤ : Month (1~9, A, B, C)
- ⑥⑦⑧⑨ : Day (1~9, A, B~V)
- ⒶⒷⒸ : Product serial number (001 ~ 999)

9. Packing Structure

a-1) Packing Process (The quantity of PKG on the Reel to be Max 2,500pcs)

Reel

A1R6S4

SPMWHT541MP5WAS0S4 A1R6S4 01
 GLAZC4001 / 1001 / 2,500 pcs



Aluminum Vinyl Packing Bag

A1R6S4

SPMWHT541MP5WAS0S4 A1R6S4 01
 GLAZC4001 / 1001 / 2,500 pcs

Outer Box

Material: Paper (SW3B(B))

| Type | Size (mm) | | | Note |
|----------|-----------|---------|---------|----------------|
| | L | W | H | |
| 7 inch L | 245 ± 5 | 220 ± 5 | 182 ± 5 | Up to 10 reels |
| 7 inch S | 245 ± 5 | 220 ± 5 | 86 ± 5 | Up to 5 reels |

A1R6S4

SPMWHT541MP5WAS0S4 A1R6S4 01
 GLAZC4001 / 1001 / 25,000 pcs

[Box Label]

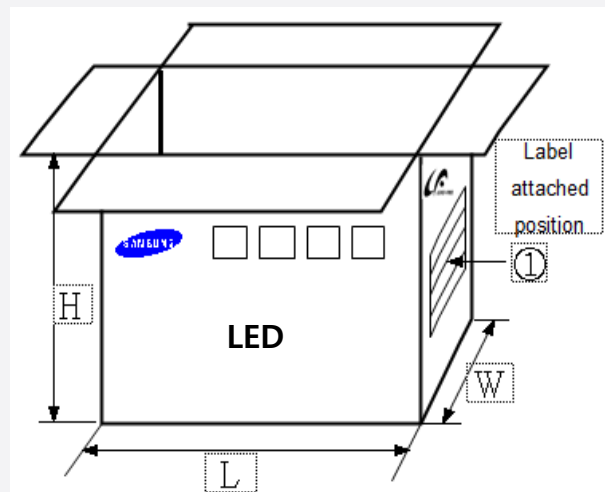

a-2) Packing Process (The quantity of PKG on the Reel to be Max 10,000pcs)

Reel

A1R6S4

SPMWHT541MP5WKS0S4 A1R6S4 01

GLAZC4001 / 1001 / 10,000 pcs

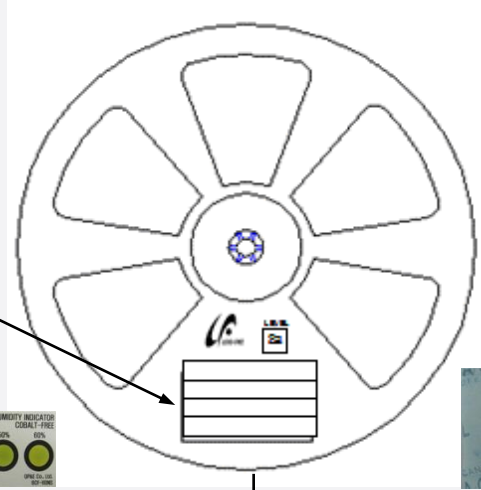

Aluminum Vinyl Packing Bag

A1R6S4

SPMWHT541MP5WKS0S4 A1R6S4 01

GLAZC4001 / 1001 / 10,000 pcs



A1R6S4

SPMWHT541MP5WKS0S4 A1R6S4 01

GLAZC4001 / 1001 / 150,000 pcs

[Box Label]

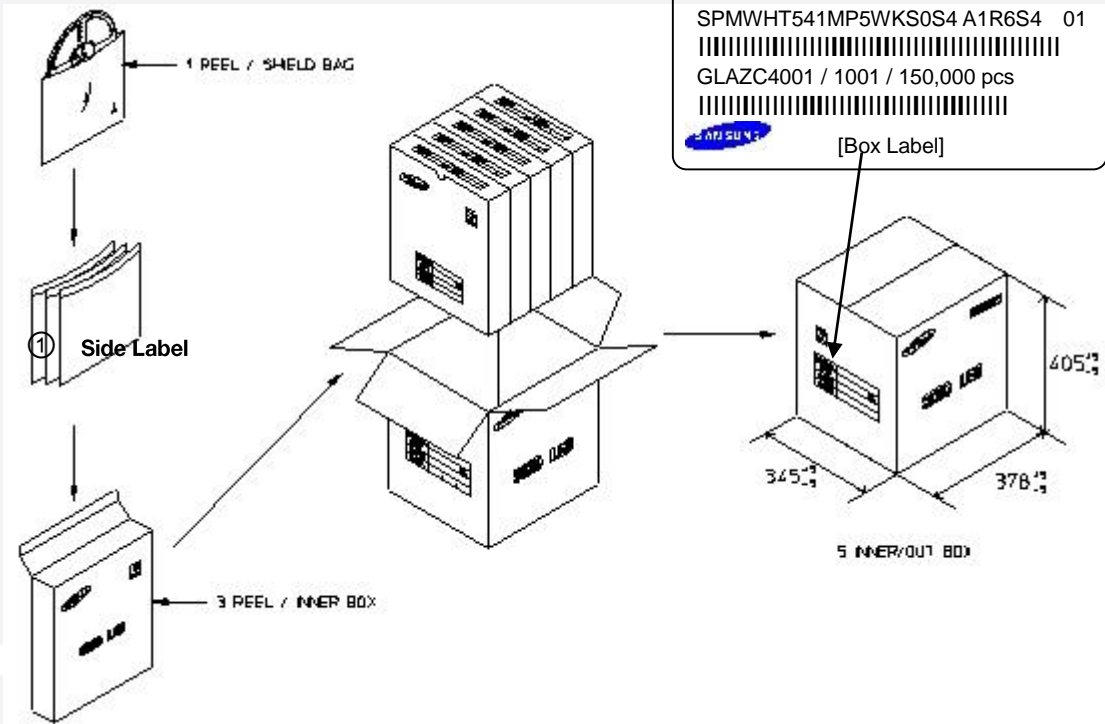

b-1) Packing Process for kitting (The quantity of PKG on the Reel to be Max 2,500pcs)

Reel

Kitting 'A'

A1◇WS4
 SPMWHT541MP5WA◇KS4 A1◇WS4 01
 GLAW94001 / 1001 / 2,500 pcs

Kitting 'B'

A1◇ZS4
 SPMWHT541MP5WA◇KS4 A1◇ZS4 01
 GLAW94001 / 1001 / 2,500 pcs



Aluminum Vinyl Packing Bag

Kitting 'A'

A1◇WS4
 SPMWHT541MP5WA◇KS4 A1◇WS4 01
 GLAW94001 / 1001 / 2,500 pcs

Kitting 'B'

A1◇ZS4
 SPMWHT541MP5WA◇KS4 A1◇ZS4 01
 GLAW94001 / 1001 / 2,500 pcs



Kitting 'A'

A1◇WS4
 SPMWHT541MP5WA◇KS4 A1◇WS4 01
 GLAW94001 / 1001 / 2,500 pcs
 [BOX Label]

Kitting 'B'



A1◇ZS4
 SPMWHT541MP5WA◇KS4 A1◇ZS4 01
 GLAW94001 / 1001 / 2,500 pcs
 [BOX Label]

Note: "◇" can be Nominal CCT code.

Outer Box

Material: Paper (SW3B(B))

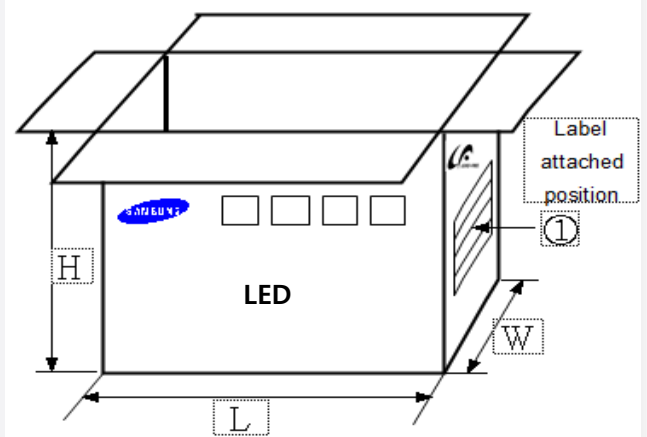
| Type | Size (mm) | | | Note |
|----------|-----------|---------|---------|----------------|
| | L | W | H | |
| 7 inch L | 245 ± 5 | 220 ± 5 | 182 ± 5 | Up to 10 reels |



b-2) Packing Process for kitting (The quantity of PKG on the Reel to be Max 10,000pcs)

Reel

Kitting 'A'

US **A1◇WS4**
 SPMWHT541MP5WK◇KS4 A1◇WS4 01
 GLAW94001 / 1001 / 10,000 pcs

Kitting 'B'

US **A1◇ZS4**
 SPMWHT541MP5WK◇KS4 A1◇ZS4 01
 GLAW94001 / 1001 / 10,000 pcs



Aluminum Vinyl Packing Bag

Kitting 'A'

US **A1◇WS4**
 SPMWHT541MP5WK◇KS4 A1◇WS4 01
 GLAW94001 / 1001 / 10,000 pcs

Kitting 'B'

US **A1◇ZS4**
 SPMWHT541MP5WK◇KS4 A1◇ZS4 01
 GLAW94001 / 1001 / 10,000 pcs

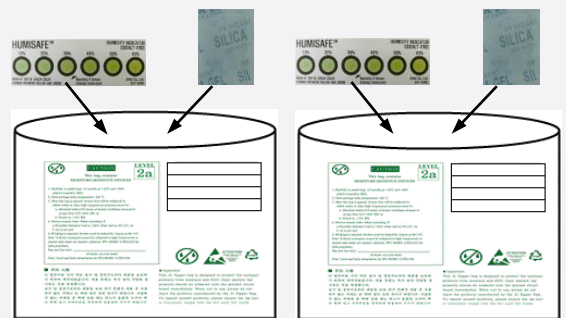

Kitting 'A'

US **A1◇WS4**
 SPMWHT541MP5WK◇KS4 A1◇WS4 01
 GLAW94001 / 1001 / 10,000 pcs
 [BOX Label]

Kitting 'B'

US **A1◇ZS4**
 SPMWHT541MP5WK◇KS4 A1◇ZS4 01
 GLAW94001 / 1001 / 10,000 pcs
 [BOX Label]

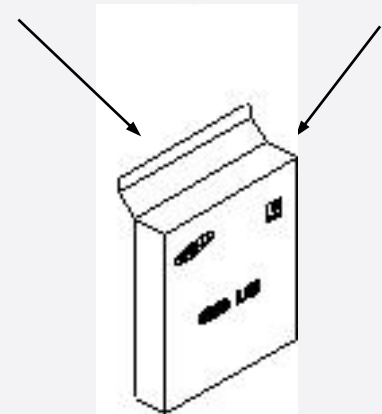

Note: "◇" can be Nominal CCT code.

Outer Box

Material: Paper (SW3B(B))

| Type | Size (mm) | | | Note |
|-----------|-----------|---------|---------|----------------|
| | L | W | H | |
| 13 inch L | 345 ± 5 | 378 ± 5 | 405 ± 5 | Up to 10 reels |

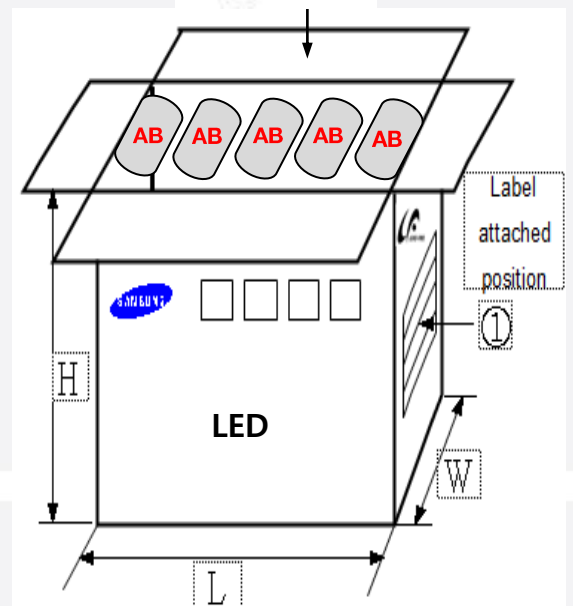

c) Aluminum Vinyl Packing Bag



CAUTION

This bag contains
MOISTURE SENSITIVE DEVICES

LEVEL

2a

c AU US **A1R6S4**

SPMWHT541MP5WAS0S4 A1R6S4 01

GLAZC4001 / 1001 / 2,500 pcs

SAMSUNG





ATTENTION

OBSERVE PRECAUTIONS
FOR HANDLING
ELECTROSTATIC
SENSITIVE
DEVICES



1. Shelf life in sealed bag: 12 months at <40°C and <90% relative humidity (RH)

2. Peak package body temperature: 240 °C

3. After this bag is opened, devices that will be subjected to reflow solder or other high temperature processes must be:

a. Mounted within 672 hours at factory conditions of equal to or less than 30°C / 60% RH, or

b. Stored at <10% RH

4. Devices require bake, before mounting, if:

a. Humidity Indicator Card is >60% when read at 23±5°C, or

b. 2a is not met.

5. If baking is required, devices must be baked for 10 ~ 24 hours at 60±5°C

Note: If device containers cannot be subjected to high temperature or shorter bake times are desired, reference IPC/JEDEC J-STD-033 for bake procedure.

Bag seal due date: _____

(If blank, see code label)

Note: Level and body temperature by IPC/JEDEC J-STD-020

■ 주의 사항

이 알루미늄 지퍼 백은 습기 및 정전기로부터 제품을 보호하기 위하여 제작되었습니다. 개봉 후에는 즉시 솔더 작업을 실시하는 것을 권장합니다.

습기 및 정전기로부터 제품을 보호 하기 위해서 개봉 후 사용하지 않는 자재는 본 팩에 넣어 보관 하시기 바랍니다. 사용하지 않는 자재를 본 팩에 넣을 때는 반드시 동봉된 드라이 팩과 함께 넣고 지퍼부분을 완전하게 밀봉하여 주시기 바랍니다.

■ Important

This Al Zipper bag is designed to protect the enclosed products from moisture and ESD. Once opened, the products should be soldered onto the printed circuit board immediately. When not in use, please do not leave the products unprotected by the Al Zipper Bag. To repack unused products., please ensure the zip-lock is completely sealed with the dry pack left inside.

d) Silica Gel & Humidity Indicator Card inside Aluminum Vinyl Bag



HUMISAFE™

10% 20% 30% 40% 50% 60%



READ AT TOP OF GREEN COLOR
CHANGE BETWEEN YELLOW AND GREEN

Warning If Green
Change Desiccant

GP&E Co., Ltd.
6CF-60NS

10. Precautions in Handling & Use

- 1) For over-current protection, users are recommended to apply resistors connected in series with the LEDs to mitigate sudden change of the forward current caused by shift of forward voltage.
- 2) This device should not be used in any type of fluid such as water, oil, organic solvent, etc. When cleaning is required, IPA is recommended as the cleaning agent. Some solvent-based cleaning agent may damage the silicone resins used in the device.
- 3) When the device is in operation, the forward current should be carefully determined considering the maximum ambient temperature and corresponding junction temperature.
- 4) LEDs must be stored in a clean environment. If the LEDs are to be stored for three months or more after being shipped from Samsung, they should be packed with a nitrogen-filled container (shelf life of sealed bags is 12 months at temperature 0~40 °C, 0~90 % RH).
- 5) After storage bag is opened, device subjected to soldering, solder reflow, or other high temperature processes must be:
 - a. Mounted within 672 hours (28 days) at an assembly line with a condition of no more than 30 °C / 60 % RH, or
 - b. Stored at <10 % RH
- 6) Repack unused devices with anti-moisture packing, fold to close any opening and then store in a dry place.
- 7) Devices require baking before mounting, if humidity card reading is >60 % at 23 ± 5 °C.
- 8) Devices must be baked for 10~24 hours at 60 ± 5 °C, if baking is required.
- 9) The LEDs are sensitive to the static electricity and surge current. It is recommended to use a wrist band or anti-electrostatic glove when handling the LEDs. If voltage exceeding the absolute maximum rating is applied to LEDs, it may cause damage or even destruction to LED devices. Damaged LEDs may show some unusual characteristics such as increase in leakage current, lowered turn-on voltage, or abnormal lighting of LEDs at low current.
- 10) VOCs (Volatile Organic Compounds) can be generated from adhesives, flux, hardener or organic additives used in luminaires (fixtures). Transparent LED silicone encapsulant is permeable to those chemicals and they may lead to a discoloration of encapsulant when they exposed to heat or light. This phenomenon can cause a significant loss of light emitted (output) from the luminaires. In order to prevent these problems, we recommend users to know the physical properties of materials used in luminaires and they must be carefully selected.
- 11) Risk of sulfurization (or tarnishing)
 The LED from Samsung uses a silver-plated lead frame and its surface color may change to black (or dark colored) when it is exposed to sulfur (S), chlorine (Cl) or other halogen compound. Sulfurization of lead frame may cause intensity degradation, change of chromaticity coordinates and, in extreme cases, open circuit. It requires caution. Due to possible sulfurization of lead frame, LED should not be used and stored together with oxidizing substances made of materials such as rubber, plain paper, lead solder cream, etc.

Legal and additional information.

[About Samsung Electronics Co., Ltd.](#)

Samsung Electronics Co. Ltd inspires the world and shapes the future with transformative ideas and technologies. The company is redefining the worlds of TVs, smartphones, wearable devices, tablets, digital appliances, network systems, and semiconductor and LED solutions. For the latest news, please visit the Samsung Newsroom at <http://news.samsung.com>.

Copyright © 2015 Samsung Electronics Co., Ltd. All rights reserved.
Samsung is a registered trademark of Samsung Electronics Co., Ltd.
Specifications and designs are subject to change without notice. Non-metric weights and measurements are approximate. All data were deemed correct at time of creation. Samsung is not liable for errors or omissions. All brand, product, service names and logos are trademarks and/or registered trademarks of their respective owners and are hereby recognized and acknowledged.

Samsung Electronics Co., Ltd.
95, Samsung 2-ro
Giheung-gu
Yongin-si, Gyeonggi-do, 446-711
KOREA

www.samsungled.com



Looking for pricing, stock, or lifecycle information?

Click below to explore more details on WIN SOURCE:

- ⊖ [View SPMWHT541MP5WASMS5 on WIN SOURCE](#)
- ⊖ [Samsung Information](#)

Optimize Your Supply Chain with WIN SOURCE Solutions

- ✓ Global Sourcing Solution
- ✓ Obsolete Management
- ✓ Cost Control Management
- ✓ Shortage Management
- ✓ Alternative Solution
- ✓ Excess Inventory Management