



**THE DATASHEET OF  
SPMWHT541MD5WAWHS1**



# LM561B – 5630 Middle Power LED



## Introduction

### Features

- Beam Angle: 120°
- Precondition : JEDEC Level 2a
- Dimension : 5.6 x 3.0 x 0.8 mm
- ESD withstand Voltage : up to  $\pm 5$ KV [HBM]

### Applications

- INDOOR LIGHTING : Ambient Light, LED tube, Down light, LED bulb and Ceiling Light

Simpex Electronic AG  
Binzackerstrasse 33  
CH-8622 Wetzikon  
Telefon +41-44-931 10 40  
Telefax +41-44-931 10 41

www.simpex.ch  
contact@simpex.ch

MwSt Nr. 235 049



## SAMSUNG ELECTRONICS

95, Samsung2-Ro, Giheung-Gu,  
Yongin-City, Gyeonggi-Do 446-711, KOREA

Copyright © 1995-2013 SAMSUNG ELECTRONICS Co.,Ltd. All rights reserved. The information in this document is subject to change without notice. SAMSUNG,  SAMSUNG is a registered trademark of SAMSUNG ELECTRONICS.

## Contents

1. Product Code Information	-----	3
2. Characteristics	-----	9
3. Typical Characteristics Graph	-----	10
4. Outline Drawing & Dimension	-----	16
5. Reliability Test Items & Conditions	-----	17
6. Solder Conditions	-----	18
7. Tape & Reel	-----	19
8. Label Structure	-----	20
9. Packing Structure	-----	21
10. Precaution For Use	-----	23
11. Hazard Substance Analysis Report	-----	26
Revision History	-----	46

# 1. Product Code Information

## 1) Luminous Flux Bins ( $T_s = 25^\circ\text{C}$ )

Nominal CCT	Product Code	Flux Rank	Sorting Condition $I_m$ @65mA
			Flux Range ( $\Phi_v, I_m$ )
2700K	SPMWHT541MD5WAW0S1	S1	24.0 ~ 26.0
	SPMWHT541MD5WAW0S2	S2	26.0 ~ 28.0
	SPMWHT541MD5WAW0S3	S3	28.0 ~ 30.0
3000K	SPMWHT541MD5WAV0S1	S1	24.5 ~ 26.5
	SPMWHT541MD5WAV0S2	S2	26.5 ~ 28.5
	SPMWHT541MD5WAV0S3	S3	28.5 ~ 30.5
3500K	SPMWHT541MD5WAU0S1	S1	25.0 ~ 27.0
	SPMWHT541MD5WAU0S2	S2	27.0 ~ 29.0
	SPMWHT541MD5WAU0S3	S3	29.0 ~ 31.0
4000K	SPMWHT541MD5WAT0S1	S1	26.0 ~ 28.0
	SPMWHT541MD5WAT0S2	S2	28.0 ~ 30.0
	SPMWHT541MD5WAT0S3	S3	30.0 ~ 32.0
5000K	SPMWHT541MD5WAR0S1	S1	27.0 ~ 29.0
	SPMWHT541MD5WAR0S2	S2	29.0 ~ 31.0
	SPMWHT541MD5WAR0S3	S3	31.0 ~ 33.0
5700K	SPMWHT541MD5WAQ0S1	S1	26.5 ~ 28.5
	SPMWHT541MD5WAQ0S2	S2	28.5 ~ 30.5
	SPMWHT541MD5WAQ0S3	S3	30.5 ~ 32.5
6500K	SPMWHT541MD5WAP0S1	S1	26.0 ~ 28.0
	SPMWHT541MD5WAP0S2	S2	28.0 ~ 30.0
	SPMWHT541MD5WAP0S3	S3	30.0 ~ 32.0

**Notes:** SAMSUNG ELECTRONICS maintains a tolerance of  $\pm 5\%$  on Luminous Flux measurements



## 2) Color Bins ( $T_s = 25^\circ\text{C}$ )

### 1) Color Binning

Nominal CCT	Product Code	Color Rank	Chromaticity Bins
2700K	SPMWHT541MD5WAW0S1 SPMWHT541MD5WAW0S2 SPMWHT541MD5WAW0S3	W0(Whole bin)	W1, W2, W3, W4, W5, W6, W7, W8, W9, WA, WB, WC, WD, WE, WF, WG
3000K	SPMWHT541MD5WAV0S1 SPMWHT541MD5WAV0S2 SPMWHT541MD5WAV0S3	V0(Whole bin)	V1, V2, V3, V4, V5, V6, V7, V8, V9, VA, VB, VC, VD, VE, VF, VG
3500K	SPMWHT541MD5WAU0S1 SPMWHT541MD5WAU0S2 SPMWHT541MD5WAU0S3	U0(Whole bin)	U1, U2, U3, U4, U5, U6, U7, U8, U9, UA, UB, UC, UD, UE, UF, UG
4000K	SPMWHT541MD5WAT0S1 SPMWHT541MD5WAT0S2 SPMWHT541MD5WAT0S3	T0(Whole bin)	T1, T2, T3, T4, T5, T6, T7, T8, T9, TA, TB, TC, TD, TE, TF, TG
5000K	SPMWHT541MD5WAR0S1 SPMWHT541MD5WAR0S2 SPMWHT541MD5WAR0S3	R0(Whole bin)	R1, R2, R3, R4, R5 R6, R7, R8, R9 ,RA
5700K	SPMWHT541MD5WAQ0S1 SPMWHT541MD5WAQ0S2 SPMWHT541MD5WAQ0S3	Q0(Whole bin)	Q1, Q2, Q3, Q4, Q5 Q6, Q7, Q8, Q9, QA
6500K	SPMWHT541MD5WAP0S1 SPMWHT541MD5WAP0S2 SPMWHT541MD5WAP0S3	P0(Whole bin)	P1, P2, P3, P4, P5 P6, P7, P8, P9, PA

## 2) Chromaticity Region & Coordinates





## 2) Chromaticity Region & Coordinates (Continued)

Region	CIE X	CIE Y	Region	CIE X	CIE Y
W rank (2700K)					
W1	0.4373	0.3893	W9	0.4465	0.4071
	0.4418	0.3981		0.4513	0.4164
	0.4475	0.3994		0.4573	0.4178
	0.4428	0.3906		0.4523	0.4085
W2	0.4428	0.3906	WA	0.4523	0.4085
	0.4475	0.3994		0.4573	0.4178
	0.4532	0.4008		0.4634	0.4193
	0.4483	0.3919		0.4582	0.4099
W3	0.4483	0.3919	WB	0.4582	0.4099
	0.4532	0.4008		0.4634	0.4193
	0.4589	0.4021		0.4695	0.4207
	0.4538	0.3931		0.4641	0.4112
W4	0.4538	0.3931	WC	0.4641	0.4112
	0.4589	0.4021		0.4695	0.4207
	0.4646	0.4034		0.4756	0.4221
	0.4593	0.3944		0.4700	0.4126
W5	0.4418	0.3981	WD	0.4513	0.4164
	0.4465	0.4071		0.4562	0.4260
	0.4523	0.4085		0.4624	0.4274
	0.4475	0.3994		0.4573	0.4178
W6	0.4475	0.3994	WE	0.4573	0.4178
	0.4523	0.4085		0.4624	0.4274
	0.4582	0.4099		0.4687	0.4289
	0.4532	0.4008		0.4634	0.4193
W7	0.4532	0.4008	WF	0.4634	0.4193
	0.4582	0.4099		0.4687	0.4289
	0.4641	0.4112		0.4750	0.4304
	0.4589	0.4021		0.4695	0.4207
W8	0.4589	0.4021	WG	0.4695	0.4207
	0.4641	0.4112		0.4750	0.4304
	0.4700	0.4126		0.4813	0.4319
	0.4646	0.4034		0.4756	0.4221

Region	CIE X	CIE Y	Region	CIE X	CIE Y
V rank (3000K)					
V1	0.4147	0.3814	V9	0.4221	0.3984
	0.4183	0.3898		0.4259	0.4073
	0.4242	0.3919		0.4322	0.4096
	0.4203	0.3833		0.4281	0.4006
V2	0.4203	0.3833	VA	0.4281	0.4006
	0.4242	0.3919		0.4322	0.4096
	0.4300	0.3939		0.4385	0.4119
	0.4259	0.3853		0.4342	0.4028
V3	0.4259	0.3853	VB	0.4342	0.4028
	0.4300	0.3939		0.4385	0.4119
	0.4359	0.3960		0.4449	0.4141
	0.4316	0.3873		0.4403	0.4049
V4	0.4316	0.3873	VC	0.4403	0.4049
	0.4359	0.3960		0.4449	0.4141
	0.4418	0.3981		0.4513	0.4164
	0.4373	0.3893		0.4465	0.4071
V5	0.4183	0.3898	VD	0.4259	0.4073
	0.4221	0.3984		0.4299	0.4165
	0.4281	0.4006		0.4364	0.4188
	0.4242	0.3919		0.4322	0.4096
V6	0.4242	0.3919	VE	0.4322	0.4096
	0.4281	0.4006		0.4364	0.4188
	0.4342	0.4028		0.4430	0.4212
	0.4300	0.3939		0.4385	0.4119
V7	0.4300	0.3939	VF	0.4385	0.4119
	0.4342	0.4028		0.4430	0.4212
	0.4403	0.4049		0.4496	0.4236
	0.4359	0.3960		0.4449	0.4141
V8	0.4359	0.3960	VG	0.4449	0.4141
	0.4403	0.4049		0.4496	0.4236
	0.4465	0.4071		0.4562	0.4260
	0.4418	0.3981		0.4513	0.4164

## 2) Chromaticity Region & Coordinates (Continued)

Region	CIE X	CIE Y	Region	CIE X	CIE Y
U rank (3500K)					
U1	0.3889	0.3690	U9	0.3941	0.3848
	0.3915	0.3768		0.3968	0.3930
	0.3981	0.3800		0.4040	0.3966
	0.3953	0.3720		0.4010	0.3882
U2	0.3953	0.3720	UA	0.4010	0.3882
	0.3981	0.3800		0.4040	0.3966
	0.4048	0.3832		0.4113	0.4001
	0.4017	0.3751		0.4080	0.3916
U3	0.4017	0.3751	UB	0.4080	0.3916
	0.4048	0.3832		0.4113	0.4001
	0.4116	0.3865		0.4186	0.4037
	0.4082	0.3782		0.4150	0.3950
U4	0.4082	0.3782	UC	0.4150	0.3950
	0.4116	0.3865		0.4186	0.4037
	0.4183	0.3898		0.4259	0.4073
	0.4147	0.3814		0.4221	0.3984
U5	0.3915	0.3768	UD	0.3968	0.3930
	0.3941	0.3848		0.3996	0.4015
	0.4010	0.3882		0.4071	0.4052
	0.3981	0.3800		0.4040	0.3966
U6	0.3981	0.3800	UE	0.4040	0.3966
	0.4010	0.3882		0.4071	0.4052
	0.4080	0.3916		0.4146	0.4089
	0.4048	0.3832		0.4113	0.4001
U7	0.4048	0.3832	UF	0.4113	0.4001
	0.4080	0.3916		0.4146	0.4089
	0.4150	0.3950		0.4222	0.4127
	0.4116	0.3865		0.4186	0.4037
U8	0.4116	0.3865	UG	0.4186	0.4037
	0.4150	0.3950		0.4222	0.4127
	0.4221	0.3984		0.4299	0.4165
	0.4183	0.3898		0.4259	0.4073

Region	CIE X	CIE Y	Region	CIE X	CIE Y
T rank (4000K)					
T1	0.367	0.3578	T9	0.3702	0.3722
	0.3726	0.3612		0.3763	0.376
	0.3744	0.3685		0.3782	0.3837
	0.3686	0.3649		0.3719	0.3797
T2	0.3726	0.3612	TA	0.3763	0.3760
	0.3783	0.3646		0.3825	0.3798
	0.3804	0.3721		0.3847	0.3877
	0.3744	0.3685		0.3782	0.3837
T3	0.3783	0.3646	TB	0.3825	0.3798
	0.3840	0.3681		0.3887	0.3836
	0.3863	0.3758		0.3912	0.3917
	0.3804	0.3721		0.3847	0.3877
T4	0.384	0.3681	TC	0.3887	0.3837
	0.3898	0.3716		0.395	0.3875
	0.3924	0.3794		0.3978	0.3958
	0.3863	0.3758		0.3912	0.3917
T5	0.3686	0.3649	TD	0.3719	0.3797
	0.3744	0.3685		0.3782	0.3837
	0.3763	0.376		0.3802	0.3916
	0.3702	0.3722		0.3736	0.3874
T6	0.3744	0.3685	TE	0.3782	0.3837
	0.3804	0.3721		0.3847	0.3877
	0.3825	0.3798		0.3869	0.3958
	0.3763	0.376		0.3802	0.3916
T7	0.3804	0.3721	TF	0.3847	0.3877
	0.3863	0.3758		0.3912	0.3917
	0.3887	0.3836		0.3937	0.4001
	0.3825	0.3798		0.3869	0.3958
T8	0.3863	0.3758	TG	0.3912	0.3917
	0.3924	0.3794		0.3978	0.3958
	0.395	0.3875		0.4006	0.4044
	0.3887	0.3836		0.3937	0.4001



## 2) Chromaticity Region & Coordinates (Continued)

Region	CIE X	CIE Y	Region	CIE X	CIE Y
R rank (5000K)					
R1	0.3366	0.3369	R6	0.3456	0.3601
	0.3441	0.3428		0.3539	0.3669
	0.3449	0.3515		0.3551	0.3760
	0.3369	0.3451		0.3464	0.3688
R2	0.3441	0.3428	R7	0.3363	0.3287
	0.3515	0.3487		0.3433	0.3341
	0.3527	0.3578		0.3441	0.3428
	0.3449	0.3515		0.3366	0.3369
R3	0.3369	0.3451	R8	0.3433	0.3341
	0.3449	0.3515		0.3503	0.3396
	0.3456	0.3601		0.3515	0.3487
	0.3373	0.3534		0.3441	0.3428
R4	0.3449	0.3515	R9	0.3376	0.3616
	0.3527	0.3578		0.3464	0.3688
	0.3539	0.3669		0.3471	0.3775
	0.3456	0.3601		0.3379	0.3698
R5	0.3373	0.3534	RA	0.3464	0.3688
	0.3456	0.3601		0.3551	0.3760
	0.3464	0.3688		0.3564	0.3851
	0.3376	0.3616		0.3471	0.3775
Q rank (5700K)					
Q1	0.3222	0.3243	Q6	0.3292	0.3461
	0.3294	0.3306		0.3373	0.3534
	0.3293	0.3384		0.3376	0.3616
	0.3217	0.3316		0.3292	0.3539
Q2	0.3294	0.3306	Q7	0.3227	0.3170
	0.3366	0.3369		0.3295	0.3228
	0.3369	0.3451		0.3294	0.3306
	0.3293	0.3384		0.3222	0.3243
Q3	0.3217	0.3316	Q8	0.3295	0.3228
	0.3293	0.3384		0.3363	0.3287
	0.3292	0.3461		0.3366	0.3369
	0.3212	0.3389		0.3294	0.3306
Q4	0.3293	0.3384	Q9	0.3207	0.3462
	0.3369	0.3451		0.3292	0.3539
	0.3373	0.3534		0.3291	0.3617
	0.3292	0.3461		0.3202	0.3535
Q5	0.3212	0.3389	QA	0.3292	0.3539
	0.3292	0.3461		0.3376	0.3616
	0.3292	0.3539		0.3379	0.3698
	0.3207	0.3462		0.3291	0.3617

Region	CIE X	CIE Y	Region	CIE X	CIE Y
P rank (6500K)					
P1	0.3068	0.3113	P6	0.3126	0.3324
	0.3145	0.3187		0.3210	0.3408
	0.3135	0.3256		0.3205	0.3481
	0.3055	0.3177		0.3117	0.3393
P2	0.3145	0.3187	P7	0.3081	0.3049
	0.3221	0.3261		0.3154	0.3119
	0.3216	0.3334		0.3145	0.3187
	0.3135	0.3256		0.3068	0.3113
P3	0.3055	0.3177	P8	0.3154	0.3119
	0.3135	0.3256		0.3226	0.3188
	0.3126	0.3324		0.3221	0.3261
	0.3041	0.3240		0.3145	0.3187
P4	0.3135	0.3256	P9	0.3028	0.3304
	0.3216	0.3334		0.3117	0.3393
	0.3210	0.3408		0.3107	0.3461
	0.3126	0.3324		0.3015	0.3368
P5	0.3041	0.3240	PA	0.3117	0.3393
	0.3126	0.3324		0.3205	0.3481
	0.3117	0.3393		0.3200	0.3554
	0.3028	0.3304		0.3107	0.3461

**Notes:** SAMSUNG ELECTRONICS maintains  $\pm 0.007$  tolerance of Cx, Cy

## 2. Characteristics

### 1) Absolute Maximum Rating

Item	Symbol	Rating	Condition
Operating temperature range	$T_{op}$	-40°C ~ +85°C	-
Storage temperature range	$T_{stg}$	-40°C ~ +120°C	-
LED junction temperature	$T_J$	110°C	-
Forward Current	$I_F$	150 mA	-
Peak Pulsed Forward Current	$I_{FP}$	300 mA	Duty 1/10 pulse width 10ms
Thermal resistance	$R_{th, j-s}$	16°C/W	Junction to solder point
Assembly Process Temperature	-	260°C, < 10sec	-
ESD	-	5kV	HBM

### 2) Electro-optical Characteristics

Item	Unit	Nominal CCT	Product Code	Rank	Min	Typ	Max		
Forward Voltage <sup>1)</sup> ( $V_F$ ) (@65 mA, $T_s = 25^\circ\text{C}$ )	V	-	-	WA	AZ	2.70	-	2.80	
					A1	2.80	-	2.90	
					A2	2.90	-	3.00	
					A3	3.00	-	3.10	
					A4	3.10	-	3.20	
Luminous Flux <sup>2)</sup> ( $\Phi_v$ ) (@65 mA, $T_s = 25^\circ\text{C}$ )	lm	2700K (W0)	*WAW0S1	S1	24.0	-	26.0		
			*WAW0S2	S2	26.0	-	28.0		
			*WAW0S3	S3	28.0	-	30.0		
		3000K (V0)	*WAV0S1	S1	24.5	-	26.5		
			*WAV0S2	S2	26.5	-	28.5		
			*WAV0S3	S3	28.5	-	30.5		
		3500K (U0)	*WAU0S1	S1	25.0	-	27.0		
			*WAU0S2	S2	27.0	-	29.0		
			*WAU0S3	S3	29.0	-	31.0		
		4000K (T0)	*WAT0S1	S1	26.0	-	28.0		
			*WAT0S2	S2	28.0	-	30.0		
			*WAT0S3	S3	30.0	-	32.0		
		5000K (R0)	*WAR0S1	S1	27.0	-	29.0		
			*WAR0S2	S2	29.0	-	31.0		
			*WAR0S3	S3	31.0	-	33.0		
		5700K (Q0)	*WAQ0S1	S1	26.5	-	28.5		
			*WAQ0S2	S2	28.5	-	30.5		
			*WAQ0S3	S3	30.5	-	32.5		
		6500K (P0)	*WAP0S1	S1	26.0	-	28.0		
			*WAP0S2	S2	28.0	-	30.0		
			*WAP0S3	S3	30.0	-	32.0		
		Reverse Voltage (@5 mA, $T_s = 25^\circ\text{C}$ )	V	-	-	-	0.7	-	1.2
		Color Rendering Index <sup>3)</sup> ( $R_a$ )	-	-	-	5	80	-	-
		Special CRI <sup>4)</sup> (R9)	-	-	-	-	0	-	-

#### Notes:

1)~4) SAMSUNG ELECTRONICS maintains a tolerance of  $V_F:\pm 0.1$  V,  $\Phi_v:\pm 5$  %,  $R_a:\pm 3.0$ ,  $R_9:\pm 6.5$  on measurements

5) " \* " is Product Code of "SPMWHT541MD5"

### 3. Typical Characteristics Graph ( $T_s = 25^\circ\text{C}$ )

#### 1) Spectrum Distribution

[CCT : 2700K & 3000K]



[CCT : 3500K & 4000K]



[CCT : 5000K & 5700K]



[CCT : 6500K]



## 2) Forward Current Characteristics

[Relative Luminous Flux vs. Forward Current]

( $T_s = 25^\circ\text{C}$ )



[Forward Current vs. Forward Voltage]

( $T_s = 25^\circ\text{C}$ )

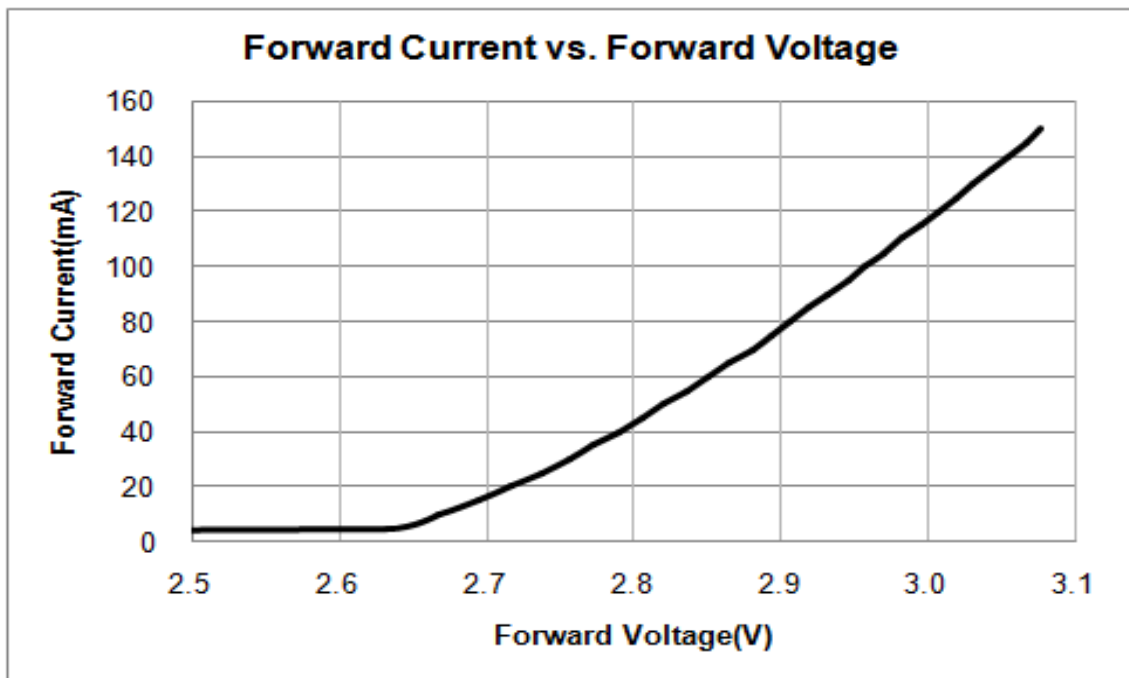

### 3) Temperature Characteristics

[Relative Luminous Flux vs.  $T_s$ ]

( $I_F = 65\text{mA}$ )



[Forward Voltage vs.  $T_s$ ]

( $I_F = 65\text{mA}$ )



#### 4) Color shift Characteristics

[Forward Current vs. Color  $\Delta x$ ,  $\Delta y$ ]

( $T_s = 25^\circ\text{C}$ )



5) Derating Curve



6) Beam Angle Characteristics



## 4. Outline Drawing & Dimension

1. Tolerance is  $\pm 0.10$  mm
2. The maximum compressing force is 15N on the body (a)
3. Do not place pressure on the encapsulation resin (b)

**Left Side View**

**Top View**

**Bottom View**



**Anode**

**Front View**

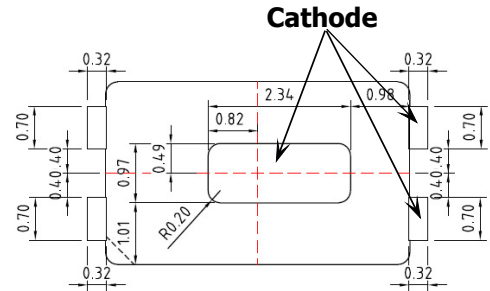

**Cathode**

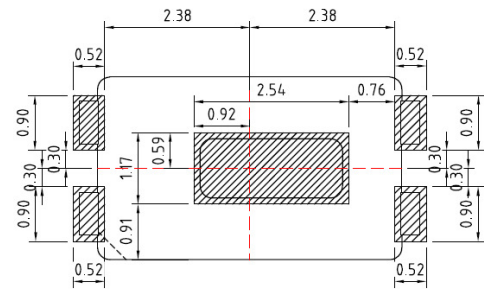

**Recommended Land Pattern**

### Notes:

- 1) This LED has built-in ESD protection device(s) connected in parallel to LED Chip(s).
- 2) Ts point & measurement method
  - ① Measure the nearest point to the thermal pad. If necessary, remove PSR of PCB to reach Ts point.
  - ② Thermal pad must be soldered to the PCB to dissipate heat properly. Otherwise, LED can be damaged.
- 3) Precautions
  - ① The pressure on the LEDs will influence to the reliability of the LEDs. Precautions should be taken to avoid the strong pressure on the LEDs. Do not put stress on the LEDs during heating.
  - ② Re-soldering should not be done after the LEDs have been soldered. If re-soldering is unavoidable, LED's characteristics should be carefully checked before and after such repair.
  - ③ Do not stack assembled PCBs together. Since materials of LEDs is soft, abrasion between two PCB assembled with LED might cause catastrophic failure of the LEDs.

## 5. Reliability Test Items and Conditions

### 1) Test Items

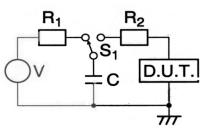
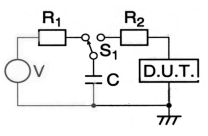
Test Item	Test Conditions	Test Hours/Cycles	Sample No	
MSL Test	125 °C 24hrs drying → 60 °C, 60 %RH 120hrs → 260 °C 10sec 3 cycles	1 cycle	11	
Room Temperature life test	25 °C±3 °C, DC150 mA	1,000 hrs	22	
High Temperature life test	85 °C±3 °C, DC150 mA	1,000 hrs	22	
High Temperature humidity life test	85 °C±3 °C, 85 %±2 %RH, DC150 mA	1,000 hrs	22	
Low Temperature life test	-40 °C±3 °C, DC150 mA	1,000 hrs	22	
Powered Temperature Cycle test	-45°C/20 min ↔ 85°C/20 min, Sweep 100min cycle on/off: each 5 min, DC 150mA	100 cycle	22	
Thermal Shock	-45 °C/15 min ↔ 125 °C/15 min → Hot plate 180 °C	500 cycle	100	
High Temperature Storage	Ta=120 °C±3 °C	1000 hrs	11	
Low Temperature Storage	Ta=-40 °C±3 °C	1000 hrs	11	
ESD(HBM)		R1:10 MΩ, R2:1.5 kΩ, C:100 pF, V = ±5 kV	5 times	5
ESD(MM)		R1:10 MΩ, R2: 0, C:200 pF, V = ±0.5 kV	5 times	5
Vibration Test	20~2000~20 Hz 200 m/s <sup>2</sup> , Sweep 4 min X, Y, Z 3 direction, each 1 cycle	4 cycles	11	
Mechanical Shock Test	1500G, 0.5 ms, 3 shocks each X-Y-Z axis	5 cycles	11	

### 2) Criteria for Judging the Damage

Item	Symbol	Test Condition	Limit	
			Min	Max
Forward Voltage	V <sub>F</sub>	I <sub>F</sub> = 65 mA	Init. Value*0.9	Init. Value*1.1
Luminous Flux	Φ <sub>v</sub>	I <sub>F</sub> = 65 mA	Init. Value*0.7	Init. Value*1.2

## 6. Solder Conditions

### 1) Reflow Conditions ( Pb Free )

Reflow Frequency : 2 times max.



### 2) For Manual Soldering

Not more than 5 seconds @Max. 300°C, under soldering iron.

# 7. Tape & Reel

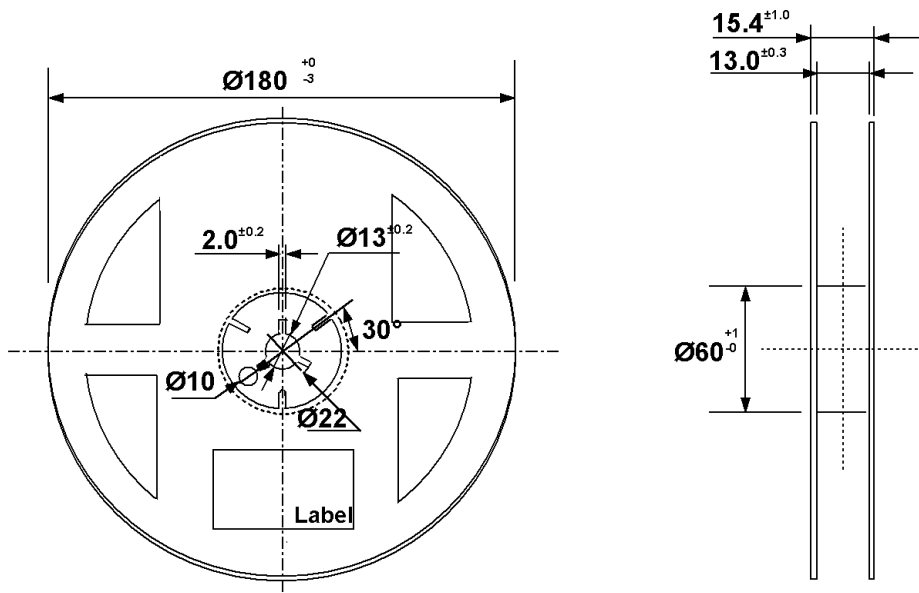

Tolerance ±0.2 , Unit:mm

- (1) Quantity : The quantity/Reel to be Max. 2,000 pcs, .
- (2) Cumulative Tolerance : Cumulative tolerance/10 pitches to be ±0.2 mm
- (3) Adhesion Strength of Cover Tape : Adhesion strength to be 0.1-0.7N when the cover tape is turned off from the carrier tape at 10°C angle to be the carrier tape.
- (4) Packaging : P/N, Manufacturing data code no. and quantity to be indicated on a damp proof Package.



## 8. Label Structure

### 1) Label Structure



N.B) Denoted rank is the only example.

'★' means All kind of Chromaticity Coordinate Rank.

### Rank Code

- (a)(b) : Forward Voltage( $V_F$ ) Rank (refer to page. 9)
- (c)(d) : Chromaticity Coordinate Rank (refer to page. 5~8)
- (e)(f) : Luminous Flux( $\Phi_v$ , lm) Rank (refer to page. 3)

### 2) LOT Number

The Lot number is composed of the following characters

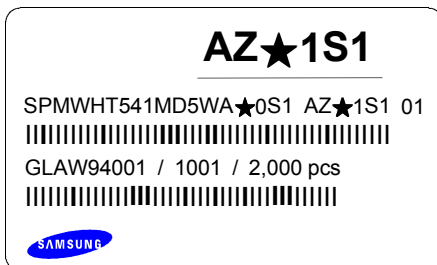

①②③④⑤⑥⑦⑧⑨ / 1(a)(b)(c) / 2,000 PCS

- ① : Production Site (S:SAMSUNG ELECTRONICS, G:GOSIN CHINA)
- ② : L (LED)
- ③ : Product State (A:Normality, B:Bulk, C:First Production, R:Reproduction, S:Sample)
- ④ : Year (V:2011, W:2012, X:2013...)
- ⑤ : Month (1 ~ 9, A, B)
- ⑥ : Day (1 ~ 9, A, B ~ V)
- ⑦⑧⑨ : SAMSUNG ELECTRONICS LED Product number (1 ~ 999)
- (a)(b)(c) : Reel Number (1 ~ 999)



# 9. Packing Structure

## 1) Packing Process

### Reel

**AZ★1S1**

SPMWHT541MD5WA★0S1 AZ★1S1 01

|||||

GLAW94001 / 1001 / 2,000 pcs

|||||



### Aluminum Vinyl Bag

**AZ★1S1**

SPMWHT541MD5WA★0S1 AZ★1S1 01

|||||

GLAW94001 / 1001 / 2,000 pcs

|||||

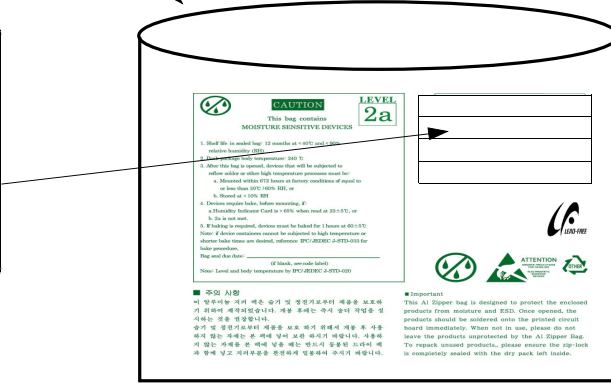

Material : Paper(SW3B(B))

TYPE	SIZE(mm)		
	L	W	H
7inch	245	220	182

### ① SIDE

**AZ★1S1**

SPMWHT541MD5WA★0S1 AZ★1S1 01

|||||

GLAW94001 / 1001 / 2,000 pcs

|||||





## 10. Precaution for use

- 1) For over-current-proof function, customers are recommended to apply resistors to prevent sudden change of the current caused by slight shift of the voltage.

과전류 방지를 위해 전압의 미세한 이동에 의해 야기되는 전류의 순간 변화를 방지하기 위해 저항 등의 설치를 권장함.

- 2) This device should not be used in any type of fluid such as water, oil, organic solvent, etc. When washing is required, IPA is recommended to use.

제품은 물, 오일, 유기물과 같은 액체 타입에서의 사용은 제한되며, 세정이 필요할 시에는 IPA 사용을 권장함.

- 3) When the LEDs illuminate, operating current should be decided after considering the ambient maximum temperature.

LED의 발광 시, 동작 전류는 주변 최고온도를 고려하여 결정되어야 함.

- 4) LEDs must be stored in a clean environment.

If the LEDs are to be stored for 3 months or more after being shipped from Samsung Electronics, they should be packed by a sealed container with nitrogen gas injected.(Shelf life of sealed bags: 12 months, temp. ~40°C, ~90%RH)

LED의 보관은 청정한 환경에서 보존되어야 하며, 만약 삼성전자로부터 공급받는 후 3개월 또는 그 이상 보관이 필요하다면 질소 가스를 동봉한 보존용기에 보관되어야 함. (보존 bag의 수명 : 12 개월, 보존 온도 ~40°C, 습도 ~90%RH)

- 5) After storage bag is open, device subjected to soldering, solder reflow, or other high temperature processes must be:

보존 Bag이 개봉된 후에, 납땀이나 reflow 등의 높은 온도에 노출되는 제품은 다음의 사항에 부합되어야 함.

- a. Mounted within 672 hours(28 days) at an assembly line with a condition of no more than 30°C/60%RH,

a. 제품은 30°C/60%RH보다 같거나 낮은 조립조건에서 672시간(28일)이내에 조립해야 함.

- b. Stored at <10%RH.

b. 10% 이하의 상대습도에서 보관되어야 함.

- 6) Repack unused Products with anti-moisture packing, fold to close any opening and then store in a dry place.

사용하지 않은 제품은 방습팩에 넣어 개봉 부위를 달아서 다시 포장한 후, 건조한 장소에서 보관할 것을 권장함.

7) Devices require baking before mounting, if humidity card reading is  $>60\%$  at  $23\pm 5^{\circ}\text{C}$ .  
만약 습도표시카드의 수치가  $23\pm 5^{\circ}\text{C}$ 에서  $60\%$  이상이라면, 제품 실장 전 **baking**해야 함.

8) Devices must be baked for 1 hour at  $65\pm 5^{\circ}\text{C}$ , if baking is required.  
만약 **baking**이 필요하다면, 제품은  $65\pm 5^{\circ}\text{C}$ 에서 1시간 정도 **baking** 되어야 함.

9) The LEDs are sensitive to the static electricity and surge. It is recommended to use a wrist band or anti-electrostatic glove when handling the LEDs.  
LED는 정전기 및 서지에 민감한 제품이므로, LED 제품을 다룰 시에는 정전기 방지장갑이나 손목밴드를 사용하기를 권장함.

If voltage exceeding the absolute maximum rating is applied to LEDs, it may cause damage or even destruction to LED devices.

만약 절대 허용치를 초과하는 전압이 LED에 가해지면, LED 소자는 파괴되거나 손상될 수 있음.

Damaged LEDs may show some unusual characteristics such as increase in leak current, lowered turn-on voltage, or abnormal lighting of LEDs at low current.

손상된 제품은 누설전류의 증가, Turn on 전압의 저하, 저 전류에서의 점등불량 등의 이상 거동을 보일 수 있음.

10) VOCs (volatile organic compounds) may be occurred by adhesives, flux, hardener or organic additives which is used in luminaires (fixture) and LED silicone bags are permeable to it. It may lead a discoloration when LED expose to heat or light.

VOCs(휘발성 유기 화합물)는 등기구에 사용되는 접착제, Flux, 경화제, 유기물 첨가제에서 발생하여 LED 실리콘 봉지체를 투과하고, 빛 또는 열에 노출되었을 때 변색이 발생 할 수 있음.

This phenomenon can give a significant loss of light emitted(output) from the luminaires(fixture).

이러한 현상은 등기구로부터 나오는 빛의 중대한 손실을 줄 수 있음.

In order to prevent these problems, we recommend you to know the physical properties for the materials used in luminaires, It requires to select carefully.

이러한 문제 발생 방지를 위해서, 등기구에 사용되는 자재에 대한 물성을 알고 주의하여 선택 되어야함.

### 11) Risk of Sulfurization (or Tarnishing)

The lead frame from Samsung Electronics is a plated package and it may change to black(or dark colored) when it is exposed to Ag (a), Sulfur (S), Cchlorine (Cl) or other halogen compound. It requires attention.

삼성전자의 리드 프레임은 Ag(은)을 도금한 Package 제품으로 황(S), 염소(Cl), 또는 다른 할로겐 화합물들에 노출시 Ag(은)은 검정(또는 어두운색)으로 바뀔 수 있으니 주의가 필요함.

Sulfide (Sulfurization) of the lead frame may cause a change of degradation intensity, chromaticity coordinates and it may cause open circuit in extreme cases. It requires attention.

리드 프레임의 황화(Sulfurization)는 광량 저하, 색좌표 변화 및 심한 경우 회로내의 LED 무등(Open) 불량을 일으킬 수도 있으니 주의가 필요함.

Sulfide (Sulfurization) of the lead frame may cause of storage and using with oxidizing substances together. Therefore, LED is not recommend to use and store with the below list.

: Rubber, Plain paper, lead solder cream etc.

리드 프레임 황화(Sulfurization)의 근원이 될 수 있으니 LED는 아래의 목록으로 만들어진 산화성 물질들과 함께 저장, 사용이 불가함 : 고무, 일반 종이, 납땜 크림 등





**Test Report No.** F690101/LF-CTSAYAA12-42152

Issued Date: 2012. 11. 28 Page 2 of 6

Sample No. : AYAA12-42152.001  
 Sample Description : MP 5830 Gen2 Warm White  
 Item No./Part No. : N/A  
 Materials : N/A

**Heavy Metals**

Test Items	Unit	Test Method	MDL	Results
Cadmium (Cd)	mg/kg	With reference to IEC 62321:2008, ICP	0.5	1.34
Lead (Pb)	mg/kg	With reference to IEC 62321:2008, ICP	5	N.D.
Mercury (Hg)	mg/kg	With reference to IEC 62321:2008, ICP	2	N.D.
Hexavalent Chromium (Cr VI)	mg/kg	With reference to IEC 62321:2008, UV-VIS	1	N.D.
Antimony (Sb)	mg/kg	With reference to EPA 3052(1996), US EPA 6010B(1996), ICP	10	N.D.
Arsenic (As)	mg/kg	With reference to EPA 3052(1996), US EPA 6010B(1996), ICP	10	N.D.
Beryllium (Be)	mg/kg	With reference to EPA 3052(1996), US EPA 6010B(1996), ICP	0.5	N.D.

**Flame Retardants-PBBs/PBDEs**

Test Items	Unit	Test Method	MDL	Results
Monobromobiphenyl	mg/kg	With reference to IEC 62321:2008, GC-MS	5	N.D.
Dibromobiphenyl	mg/kg	With reference to IEC 62321:2008, GC-MS	5	N.D.
Tribromobiphenyl	mg/kg	With reference to IEC 62321:2008, GC-MS	5	N.D.
Tetrabromobiphenyl	mg/kg	With reference to IEC 62321:2008, GC-MS	5	N.D.
Pentabromobiphenyl	mg/kg	With reference to IEC 62321:2008, GC-MS	5	N.D.
Hexabromobiphenyl	mg/kg	With reference to IEC 62321:2008, GC-MS	5	N.D.
Heptabromobiphenyl	mg/kg	With reference to IEC 62321:2008, GC-MS	5	N.D.
Octabromobiphenyl	mg/kg	With reference to IEC 62321:2008, GC-MS	5	N.D.
Nonabromobiphenyl	mg/kg	With reference to IEC 62321:2008, GC-MS	5	N.D.
Decabromobiphenyl	mg/kg	With reference to IEC 62321:2008, GC-MS	5	N.D.
Monobromodiphenyl ether	mg/kg	With reference to IEC 62321:2008, GC-MS	5	N.D.
Dibromodiphenyl ether	mg/kg	With reference to IEC 62321:2008, GC-MS	5	N.D.
Tribromodiphenyl ether	mg/kg	With reference to IEC 62321:2008, GC-MS	5	N.D.
Tetrabromodiphenyl ether	mg/kg	With reference to IEC 62321:2008, GC-MS	5	N.D.
Pentabromodiphenyl ether	mg/kg	With reference to IEC 62321:2008, GC-MS	5	N.D.
Hexabromodiphenyl ether	mg/kg	With reference to IEC 62321:2008, GC-MS	5	N.D.

- NOTE:
- (1) N.D. = Not detected.(<MDL)
  - (2) mg/kg = ppm
  - (3) MDL = Method Detection Limit
  - (4) - = No regulation
  - (5) Negative = Undetectable / Positive = Detectable
  - (6) \*\* = Qualitative analysis (No Unit)
  - (7) \* = Boiling-water-extraction:  
 Negative = Absence of CrVI coating  
 Positive = Presence of CrVI coating; the detected concentration in boiling-water-extraction solution is equal or greater than 0.02 mg/kg with 50 cm2 sample surface area.

This document is issued by the Company subject to its General Conditions of Service printed overleaf, available on request or accessible at [www.sgs.com](http://www.sgs.com). The Company's liability is limited to the extent of the services provided. Any order or request for a test or analysis shall be subject to the Company's Standard Terms and Conditions of Sale. The Company's liability is limited to the extent of the services provided. Any order or request for a test or analysis shall be subject to the Company's Standard Terms and Conditions of Sale. The Company's liability is limited to the extent of the services provided. Any order or request for a test or analysis shall be subject to the Company's Standard Terms and Conditions of Sale.

**Test Report No. F690101/LF-CTSAYAA12-42152**

Issued Date: 2012. 11. 28 Page 3 of 6

**Sample No.** : AYAA12-42152.001  
**Sample Description** : MP 5830 Gen2 Warm White  
**Item No./Part No.** : N/A  
**Materials** : N/A

**Flame Retardants-PBBs/PBDEs**

Test Items	Unit	Test Method	MDL	Results
Heptabromodiphenyl ether	mg/kg	With reference to IEC 62321:2008, GC-MS	5	N.D.
Octabromodiphenyl ether	mg/kg	With reference to IEC 62321:2008, GC-MS	5	N.D.
Nonabromodiphenyl ether	mg/kg	With reference to IEC 62321:2008, GC-MS	5	N.D.
Decabromodiphenyl ether	mg/kg	With reference to IEC 62321:2008, GC-MS	5	N.D.

**Halogen Content**

Test Items	Unit	Test Method	MDL	Results
Bromine(Br)	mg/kg	BS EN 14582:2007 , IC	30	N.D.
Chlorine(Cl)	mg/kg	BS EN 14582:2007 , IC	30	N.D.
Fluorine(F)	mg/kg	BS EN 14582:2007 , IC	30	112
Iodine(I)	mg/kg	BS EN 14582:2007 , IC	50	N.D.

**Organotin Compounds**

Test Items	Unit	Test Method	MDL	Results
Monobutyltin (MBT)	mg/kg	DIN 38407-13 , GC/MS	0.1	N.D.
Dibutyltin (DBT)	mg/kg	DIN 38407-13 , GC/MS	0.1	N.D.
Tributyltin (TBT)	mg/kg	DIN 38407-13 , GC/MS	0.1	N.D.
Bis (tributyltin)oxide (TBTO)	mg/kg	DIN 38407-13 , GC/MS	0.1	N.D.
Tetrabutyltin (TeBT)	mg/kg	DIN 38407-13 , GC/MS	0.1	N.D.
Triphenyltin (TPhT)	mg/kg	DIN 38407-13 , GC/MS	0.1	N.D.
Monooctyltin(MOT)	mg/kg	DIN 38407-13 , GC/MS	0.1	N.D.
Diocetyl tin(DOT)	mg/kg	DIN 38407-13 , GC/MS	0.1	N.D.

**Other(s)**

Test Items	Unit	Test Method	MDL	Results
PFOS (Perfluorooctane Sulfonates-Acid/Metal Salt/Amide)	mg/kg	US EPA 3540C/3550C, LC/MS	1	N.D.

**NOTE:**

- (1) N.D. = Not detected.(<MDL)
- (2) mg/kg = ppm
- (3) MDL = Method Detection Limit
- (4) - = No regulation
- (5) Negative = Undetectable / Positive = Detectable
- (6) \*\* = Qualitative analysis (No Unit)
- (7) \* = Boiling-water-extraction:  
 Negative = Absence of CrVI coating  
 Positive = Presence of CrVI coating; the detected concentration in boiling-water-extraction solution is equal or greater than 0.02 mg/kg with 50 cm2 sample surface area.

This document is issued by the Company subject to its General Conditions of Service (which are available on request or accessible at [www.sgs.com](http://www.sgs.com)) and for electronic format documents, subject to Terms and Conditions for Electronic Documents at [www.sgs.com](http://www.sgs.com). Neither is it to be taken as a warranty, indemnification or a liability release. Any order or the acceptance of this document is deemed to be an order for the Company's services and the Client's responsibility for the accuracy of the data and the quality of the results. The Client shall be responsible for the accuracy of the data and the quality of the results. The Client shall be responsible for the accuracy of the data and the quality of the results. The Client shall be responsible for the accuracy of the data and the quality of the results.

F052 Version5

SGS Korea Co.,Ltd.

 322, The O valley, 555-8, Hoge-dong, Dongan-gu, Anyang-si, Gyeonggi-do, Korea 431-060  
 T +82 (0)31 4606 000 F +82 (0)31 4606 059 <http://www.sgs.com> [www.kr.sgs.com](http://www.kr.sgs.com)

Member of the SGS Group (Société Générale de Surveillance)



Test Report No. F690101/LF-CTSAYAA12-42152

Issued Date: 2012. 11. 28 Page 4 of 6

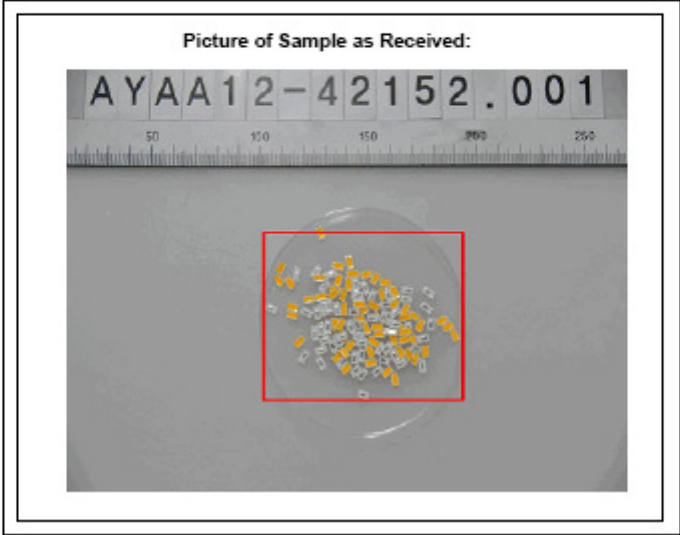

NOTE:

- (1) N.D. = Not detected.(<MDL)
- (2) mg/kg = ppm
- (3) MDL = Method Detection Limit
- (4) - = No regulation
- (5) Negative = Undetectable / Positive = Detectable
- (6) \*\* = Qualitative analysis (No Unit)
- (7) \* = Boiling-water-extraction:  
 Negative = Absence of CrVI coating  
 Positive = Presence of CrVI coating; the detected concentration in boiling-water-extraction solution is equal or greater than 0.02 mg/kg with 50 cm2 sample surface area.

This document is issued by the Company subject to its General Conditions of Service printed overleaf, available on request or accessible at <http://www.sgs.com/Products-and-Services/SGS%20for%20electronic%20documents>, subject to Terms and Conditions for Electronic Documents at <http://www.sgs.com/Products-and-Services/SGS%20for%20electronic%20documents>. All rights reserved. Any transfer of this document to a third party without the written consent of the Company is prohibited. The Company's liability is limited to the extent of the actual value of the sample provided to the Company and does not extend to any consequential or other damages. The Company's liability is limited to the extent of the actual value of the sample provided to the Company and does not extend to any consequential or other damages. The Company's liability is limited to the extent of the actual value of the sample provided to the Company and does not extend to any consequential or other damages. Unless otherwise indicated, the results shown in this report represent only the sample(s) selected and each sample(s) are related to: 30 days only.

SGS Korea Co., Ltd.

322, The O valley, 555-9, Hoge-dong, Dongan-gu, Anyang-si, Gyeonggi-do, Korea 431-060  
 t +82 (0)31 4806 000 f +82 (0)31 4806 059 <http://www.sgs.com/Products-and-Services/SGS%20for%20electronic%20documents>

F052 Version5

Member of the SGS Group (Société Générale de Surveillance)



Test Report No. F690101/LF-CTSAYAA12-42152

Issued Date: 2012. 11. 28 Page 5 of 6

Testing Flow Chart for RoHS: Cd/Pb/Hg/Cr<sup>6+</sup> /PBBs&PBDEs Testing



The samples were dissolved totally by pre-conditioning method according to above flow chart for Cd,Pb,Hg.  
Section Chief : Gilsae Yi

NOTE:

- (1) N.D. = Not detected.(<MDL)
- (2) mg/kg = ppm
- (3) MDL = Method Detection Limit
- (4) - = No regulation
- (5) Negative = Undetectable / Positive = Detectable
- (6) \*\* = Qualitative analysis (No Unit)
- (7) \* = Boiling-water-extraction:  
 Negative = Absence of CrVI coating  
 Positive = Presence of CrVI coating; the detected concentration in boiling-water-extraction solution is equal or greater than 0.02 mg/kg with 50 cm2 sample surface area.

This document is issued by the Company subject to its General Conditions of Service printed overleaf, available on request or accessible at <http://www.sgs.com/Products/Services/SGS%20Lab%20Services.pdf> for electronic format documents, subject to Terms and Conditions for Electronic Documents at <http://www.sgs.com/Products/Services/SGS%20Lab%20Services.pdf>. All rights reserved. No part of this document may be reproduced, stored in a retrieval system, or transmitted, in any form or by any means, electronic, mechanical, photocopying, recording, or otherwise, without the prior written permission of the Company. The Company's liability is limited to the extent of the actual work performed and does not extend to any consequential or special damages. The Company's liability is limited to the extent of the actual work performed and does not extend to any consequential or special damages. The Company's liability is limited to the extent of the actual work performed and does not extend to any consequential or special damages. Unless otherwise stated the results shown in this test report refer only to the samples tested and such samples are retained for 90 days only.



Flow Chart for Halogen Test



NOTE:

- (1) N.D. = Not detected.(<MDL)
- (2) mg/kg = ppm
- (3) MDL = Method Detection Limit
- (4) - = No regulation
- (5) Negative = Undetectable / Positive = Detectable
- (6) \*\* = Qualitative analysis (No Unit)
- (7) \* = Boiling-water-extraction:  
 Negative = Absence of CrVI coating  
 Positive = Presence of CrVI coating; the detected concentration in boiling-water-extraction solution is equal or greater than 0.02 mg/kg with 50 cm2 sample surface area.

This document is issued by the Company subject to its General Conditions of Service and/or special conditions on request or available at [www.samsungled.com](http://www.samsungled.com) for electronic format documents, subject to Terms and Conditions for Electronic Documents at [www.samsungled.com/notice](http://www.samsungled.com/notice). All rights reserved. All trademarks are the property of their respective owners. Any failure of this document to print the information contained herein reflects the Company's liability and is not the responsibility of the printer. The Company's liability is limited to the extent of the document does not constitute a warranty of any kind, including without limitation, the accuracy, completeness, timeliness, or appropriateness of the information contained herein. This document cannot be reproduced except in full, without the written approval of the Company. Any unauthorized alteration, copying or distribution of this document in whole or in part may be prosecuted. Documents issued on this day.

# 11. Hazard Substance Analysis - SVHC(REACH)



**Test Report No.** F690101/LF-CTSAYAA12-42151    **Issued Date:** November 30, 2012    **Page** 1 of 14

To: **SAMSUNG ELECTRONICS CO., LTD.**  
San 24, Nongseo-dong  
Giheung-gu  
Yongin-si  
Gyeonggi-do  
Korea

The following sample(s) was/were submitted and identified by/on behalf of the client as:-

---

<b>Product Name</b>	: MP 5630 Gen2 Warm White
<b>Item/Part Name</b>	: N/A
<b>SGS File No.</b>	: AYAA12-42151
<b>Received Date</b>	: November 23, 2012
<b>Test Period</b>	: November 26, 2012 ~ November 30, 2012
<b>Test Performed</b>	: SGS Korea tested the sample(s) selected by applicant with following results
<b>Test Requested</b>	: Eighty-four (84) substances in the Candidate List of Substances of Very High Concern (SVHC) for authorization published by European Chemicals Agency (ECHA) on and before June 18, 2012 regarding Regulation (EC) No 1907/2006 concerning the REACH.  Fifty-four (54) substances in the Public Consultation List of potential Substances of Very High Concern (SVHC) published by European Chemicals Agency (ECHA) on September 03, 2012 regarding Regulation (EC) No 1907/2006 concerning the REACH.
<b>Test Method</b>	: Please refer to next page(s).
<b>Test Result(s)</b>	: Please refer to next page(s).
<b>Summary</b>	: According to the specified scope and analytical technique, concentrations of all SVHC are <0.1% in the submitted sample(s).

Timothy Jeon  
Cindy park  
Jinhee Kim  
Sophia Kim  
/Testing Person

SGS Korea Co., Ltd

Jeff Jang / Chemical Lab Mgr

This document is issued by the Company subject to the General Conditions of Service printed or verbal, available on request or accessible at <http://www.sgs.com> and/or <http://www.sgs.com/sgs> and, for clients' terms documents, subject to Terms and Conditions for Electronic Documents at <http://www.sgs.com/sgs/sgs>. Attention is drawn to the limitation of liability, indemnification and jurisdiction clause defined herein. Any holder of this document is advised that it remains the property of the Company and that it is non-transferable and not to be used for any other purpose without the prior written consent of the Company. The Company's sole responsibility is to the Client and this document does not constitute advice or a guarantee from exceeding all other rights and obligations under the relevant documents. This document cannot be reproduced except in full without prior written consent of the Company. Any unauthorized alteration, forgery or falsification of the content or appearance of this document is illegal and is subject to civil and criminal penalties. This document cannot be reproduced except in full without prior written consent of the Company.

F052 Version 5

SGS Korea Co., Ltd.

322, The Ovalway, 555-a, Hoge-dong, Dongan-gu, Anyang-si, Gyeonggi-do, Korea 431-050  
t+82 (0)21 4608 000 f+82 (0)21 4608 050 <http://www.sgslab.co.kr> [www.kr.sgs.com/sgs/sgs](http://www.kr.sgs.com/sgs/sgs)

Member of the SGS Group (Société Générale de Surveillance)



**Test Report No.** F690101/LF-CTSAYAA12-42151    **Issued Date:** November 30, 2012    **Page 2 of 14**

**Test Method:**

SGS In-House method - Analyzed by ICP-OES, PLM, UV/VIS, LC/MS ,GC/MS and colorimetric method

**Remarks:**

1. The chemical analysis of specified SVHC is performed by means of currently available analytical techniques against the following SVHC related documents published by ECHA:  
<http://echa.europa.eu/web/guest/candidate-list-table> (Candidate list)  
[http://echa.europa.eu/en/web/guest/view-article/-/journal\\_content/512b7526-9dd6-4872-934e-8c298c89ad99](http://echa.europa.eu/en/web/guest/view-article/-/journal_content/512b7526-9dd6-4872-934e-8c298c89ad99) (Potential list)  
These lists are under evaluation by ECHA and may subject to change in the future.
2. In accordance with Regulation (EC) No 1907/2006, any producer or importer of articles shall notify ECHA, in accordance with paragraph 2 of Article 7, if a substance meets the criteria in Article 57 and is identified in accordance with Article 59(1) of the Regulation, if (a) the substance is present in those articles in quantities totaling over one tonne per producer or importer per year; and (b) the substance is present in those articles above a concentration of 0.1% weight by weight (w/w).
3. Article 33 of Regulation (EC) No 1907/2006 requires supplier of an article containing a substance meeting the criteria in Article 57 and identified in accordance with Article 59(1) in a concentration above 0.1% weight by weight (w/w) shall provide the recipient of the article with sufficient information, available to the supplier, to allow safe use of the article including, as a minimum, the name of that substance in the Candidate List.
4. SGS adopts the interpretation of ECHA for SVHC in article unless indicated otherwise. Detail explanation is available at the following link:  
- [http://webstage.contribute.sgs.net/corpreach/documents/SGS-CTS\\_SVHC-paper-EN-11.pdf](http://webstage.contribute.sgs.net/corpreach/documents/SGS-CTS_SVHC-paper-EN-11.pdf)
5. Test results in this report are based on the tested sample. This report refers to testing result of composite material group by equal weight proportion. The material in each composite test group may come from one article.
6. If a SVHC is found over the reporting limit, client is suggested to identify the component which contains the SVHC and the exact concentration of the SVHC by requesting further quantitative analysis from the laboratory.

This document is issued by the Company subject to its General Conditions of Service printed on each report, available on request or accessible at <http://www.sgs.com/~/media/SGS/ServiceConditions.pdf> and its clients' Terms of Service, subject to Terms and Conditions for Electronic Documents at <http://www.sgs.com/~/media/SGS/ServiceConditions.pdf>. Attention is drawn to the limitation of liability, indemnification and jurisdiction clauses defined therein. Any holder of this document is advised that information contained herein reflects the Company's findings at the time of its issue which may not reflect the findings of the Client's subsequent testing. The Company's sole responsibility is to its Client and this document does not constitute advice or a guarantee from regarding all their rights and obligations under the applicable law. This document cannot be reproduced except in full without prior written consent of the Company. Any unauthorized disclosure, copying, or modification of the content or suppression of this document is subject to legal action. The Company may be contacted at [sgs@sgs.com](mailto:sgs@sgs.com) or <http://www.sgs.com>. Unless otherwise stated, the results shown in this test report refer only to the sample(s) tested and each sample(s) are marked as 'M' (see page 1).

F052 Version 5

SGS Korea Co., Ltd.

322, The Ovalley, 555-a, Hogeje-dong, Dongan-gu, Anyang-si, Gyeonggi-do, Korea 431-050  
t:+82 (0)21 4608 000 f:+82 (0)21 4608 000 <http://www.sgslab.co.kr> [www.kr.sgs.com/greenlab](http://www.kr.sgs.com/greenlab)

Member of the SGS Group (Société Générale de Surveillance)



**Test Report No.** F690101/LF-CTSAYAA12-42151 **Issued Date:** November 30, 2012 **Page 3 of 14**

**Test Result(s)**

Substance Name	CAS number	EC number	Concentration (%)	Reporting Limit (%)	Classification
Alkanes, C10-13, chloro (Short Chain Chlorinated Paraffins)	85535-84-8	287-476-5	N.D.	0.05	PBT
Anthracene	120-12-7	204-371-1	N.D.	0.05	PBT
Benzyl butyl phthalate (BBP)	85-68-7	201-622-7	N.D.	0.05	Toxic for Reproduction
Bis(2-ethylhexyl)phthalate (DEHP)	117-81-7	204-211-0	N.D.	0.05	Toxic for Reproduction
Bis(tributyltin)oxide	56-35-9	200-268-0	N.D.	0.05	PBT
Cobalt dichloride*	7646-79-9	231-589-4	N.D.	0.005	Carcinogen Toxic for Reproduction
4,4-Diaminodiphenylmethane	101-77-9	202-974-4	N.D.	0.05	Carcinogen
Diarsenic pentaoxide*	1303-28-2	215-116-9	N.D.	0.005	Carcinogen
Diarsenic trioxide*	1327-53-3	215-481-4	N.D.	0.005	Carcinogen
Dibutyl phthalate (DBP)	84-74-2	201-557-4	N.D.	0.05	Toxic for Reproduction
Hexabromocyclododecane (HBCDD) and all major diastereoisomers identified (α-HBCDD, β-HBCDD, γ-HBCDD)	25637-99-4and 3194-55-6 (134237-51-7, 134237-50-6, 134237-52-8)	247-148-4 and 221-695-9	N.D.	0.05	PBT
Lead hydrogen arsenate*	7784-40-9	232-064-2	N.D.	0.005	Carcinogen Toxic for Reproduction
Sodium dichromate (Sodium dichromate, dehydrate)	10588-01-9 (7789-12-0)	234-190-3	N.D.	0.005	Carcinogen Mutagen Toxic for Reproduction
5-tert-butyl-2,4,6-trinitro-m-xylene (musk xylene)	81-15-2	201-329-4	N.D.	0.05	vPvB
Triethyl arsenate*	15606-95-8	427-700-2	N.D.	0.005	Carcinogen

This document is issued by the Company subject to the General Conditions of Service printed on each analytical report or available at <http://www.sgs.com> and for clients' internal documents, subject to Terms and Conditions for Electronic Documents at <http://www.sgs.com>. The Company is not responsible for the Client's liability, indemnification and/or other claims against the Client or the Company arising from the use of its services and/or the Client's use of the Company's data and/or information. The Client is responsible for the accuracy of the data and/or information provided to the Company and for the use of its services and/or the Client's use of the Company's data and/or information. The Client is responsible for the accuracy of the data and/or information provided to the Company and for the use of its services and/or the Client's use of the Company's data and/or information. The Client is responsible for the accuracy of the data and/or information provided to the Company and for the use of its services and/or the Client's use of the Company's data and/or information.

F052 Version 5

SGS Korea Co., Ltd.

322, The Ovalley, 555-s, Hoge-dong, Dongan-gu, Anyang-si, Gyeonggi-do, Korea 431-050  
 t+82 (0)31 4508 000 f+82 (0)31 4508 000 <http://www.sgslab.co.kr> [www.kr.sgs.com](http://www.kr.sgs.com) [gsnet@sgs.com](mailto:gsnet@sgs.com)

Member of the SGS Group (Société Générale de Surveillance)

Substance Name	CAS number	EC number	Concentration (%)	Reporting Limit (%)	Classification
Di-isobutyl phthalate(DIBP)	84-69-5	201-553-2	N.D.	0.05	Toxic for Reproduction
2,4-Dinitrotoluene	121-14-2	204-450-0	N.D.	0.05	Carcinogen
Tris(2-chloroethyl) phosphate	115-96-8	204-118-5	N.D.	0.05	Toxic for Reproduction
Anthracene oil	90640-80-5	292-602-7	N.D.	0.05	PBT; vPvB Carcinogen
Anthracene oil, anthracene paste; distn. Lights	91995-17-4	295-278-5	N.D.	0.05	PBT; vPvB Carcinogen Mutagen
Anthracene oil, anthracene paste, anthracene fraction	91995-15-2	295-275-9	N.D.	0.05	PBT; vPvB Carcinogen Mutagen
Anthracene oil, anthracene-low	90640-82-7	292-604-8	N.D.	0.05	PBT; vPvB Carcinogen Mutagen
Anthracene oil, anthracene paste	90640-81-6	292-603-2	N.D.	0.05	PBT; vPvB Carcinogen Mutagen
Coal tar pitch, high temperature	65996-93-2	266-028-2	N.D.	0.05	PBT; vPvB Carcinogen
Lead sulfochromate yellow (C.I. Pigment Yellow 34)*	1344-37-2	215-693-7	N.D.	0.005	Carcinogen Toxic for Reproduction
Lead chromate molybdate sulfate red (C.I. Pigment Red 104)*	12656-85-8	235-759-9	N.D.	0.005	Carcinogen Toxic for Reproduction
Lead chromate*	7758-97-6	231-846-0	N.D.	0.005	Carcinogen Toxic for Reproduction
Acrylamide	79-06-01	201-173-7	N.D.	0.05	Carcinogen Mutagen

This document is issued by the Company subject to its General Conditions of Service printed on each available on request or accessible at <http://www.sgs.com/~/media/SGS/ServiceConditions.aspx> and its standard Terms, Conditions, subject to Terms and Conditions for Electronic Documents at <http://www.sgs.com/~/media/SGS/ServiceConditions.aspx>. Attention is drawn to the limitation of liability, indemnification and jurisdiction clause defined therein. Any holder of this document is advised that information contained herein reflects the Company's findings and that of its laboratories at Client's expense. If any. The Company's sole responsibility is to Client and this document does not constitute advice or a guarantee. The Company's findings and those of its laboratories are for information only and do not constitute a recommendation. This document cannot be reproduced except in full, without prior written approval of the Company. Any unauthorized alteration, copying or distribution of this document is prohibited and offenders may be prosecuted accordingly. Member of the SGS Group. Unless otherwise stated, the results shown in this test report refer only to the sample(s) tested and each sample(s) was received for 30 days only.

Substance Name	CAS number	EC number	Concentration (%)	Reporting Limit (%)	Classification
Boric acid*	10043-35-3 11113-50-1	233-139-2 234-343-4	N.D.	0.005	Toxic for Reproduction
Disodium tetraborate, anhydrous*	1330-43-4 12179-04-3 1303-96-4	215-540-4	N.D.	0.005	Toxic for Reproduction
Tetraboron disodium heptaoxide, hydrate*	12267-73-1	235-541-3	N.D.	0.005	Toxic for Reproduction
Trichloroethylene	79-01-6	201-167-4	N.D.	0.05	Carcinogen
Sodium chromate*	7775-11-3	231-889-5	N.D.	0.005	Carcinogen Mutagen Toxic for Reproduction
Ammonium dichromate*	7789-09-5	232-143-1	N.D.	0.005	Carcinogen Mutagen Toxic for Reproduction
Potassium dichromate*	7778-50-9	231-906-6	N.D.	0.005	Carcinogen Mutagen Toxic for Reproduction
Potassium chromate*	7789-00-6	232-140-5	N.D.	0.005	Carcinogen Mutagen

This document is issued by the Company subject to its General Conditions of Service printed on sheet, available on request or accessible at <http://www.sgs.com/Company/Conditions.aspx> and, for clients' Personal Documents, subject to Terms and Conditions for Electronic Documents at <http://www.sgs.com/Company/Conditions.aspx>. Attention is drawn to the limitation of liability, indemnification and jurisdiction clause defined therein. Any holder of this document is advised that electronic format version differs from the Company's findings as the level of its information only and with the risk of data transmission. It is the Company's sole responsibility as to Client and this document does not constitute advice or information from involving all their rights and obligations under the respective documents. This document cannot be reproduced except in full, without prior written consent of the Company. Any unauthorized download, usage, or fabrication of the content or reproduction of this document is prohibited and offenders may be prosecuted to the fullest extent of the law. Unless otherwise stated, the results shown in this test report refer only to the sample(s) tested and each sample(s) determined for 30 days only.

F052 Version 5

SGS Korea Co., Ltd.

322, The Ovalley, 555-a, Hogeje-dang, Dongan-gu, Anyang-si, Gyeonggi-do, Korea 431-050  
 t+82 (0)31 4608 000 f+82 (0)31 4608 000 <http://www.sgslab.co.kr> [www.kr.sgs.com/guestlab](http://www.kr.sgs.com/guestlab)

Member of the SGS Group (Società Générale de Surveillance)

Substance Name	CAS number	EC number	Concentration (%)	Reporting Limit (%)	Classification
Cobalt(II) sulphate*	10124-43-3	233-334-2	N.D.	0.005	Carcinogen Toxic for Reproduction
Cobalt(II) dinitrate*	10141-05-6	233-402-1	N.D.	0.005	Carcinogen Toxic for Reproduction
Cobalt(II) carbonate*	513-79-1	208-169-4	N.D.	0.005	Carcinogen Toxic for Reproduction
Cobalt(II) diacetate*	71-48-7	200-755-8	N.D.	0.005	Carcinogen Toxic for Reproduction
2-Methoxyethanol	109-86-4	203-713-7	N.D.	0.05	Toxic for Reproduction
2-Ethoxyethanol	110-80-5	203-804-1	N.D.	0.05	Toxic for Reproduction
Chromium trioxide*	1333-82-0	215-607-8	N.D.	0.005	Carcinogen Mutagen
Acids generated from chromium trioxide and their oligomers:  Chromic acid Dichromic acid  Oligomers of chromic acid and dichromic acid*	7738-94-5 13530-68-2 - -	231-801-5 236-881-5 - -	N.D.	0.005	Carcinogen
1-methyl-2-pyrrolidone	872-50-4	212-828-1	N.D.	0.05	Toxic for Reproduction
2-ethoxyethyl acetate	111-15-9	203-839-2	N.D.	0.05	Toxic for Reproduction
1,2-benzenedicarboxylic acid, di-C6-8-branched alkyl esters, C7-rich	71888-89-6	276-158-1	N.D.	0.05	Toxic for Reproduction
1,2-benzenedicarboxylic acid, di-C7-11-branched and linear alkyl esters	68515-42-4	271-084-6	N.D.	0.05	Toxic for Reproduction
1,2,3-trichloropropane	96-18-4	202-486-1	N.D.	0.05	Carcinogen Toxic for Reproduction
Hydrazine	7803-57-8 302-01-2	206-114-9	N.D.	0.05	Carcinogen
Strontium chromate*	7789-06-2	232-142-6	N.D.	0.005	Carcinogen

This document is issued by the Company subject to its General Conditions of Service printed on each available on request or accessible at <http://www.sgs.com/~/media/SGS/ServiceConditions.pdf> and its standard terms, documents, subject to Terms and Conditions for Electronic Documents at <http://www.sgs.com/~/media/SGS/ServiceConditions.pdf>. Attention is drawn to the limitation of liability, indemnification and jurisdiction laws defined therein. Any holder of this document is advised that information contained herein reflects the Company's findings and that of its laboratories only and not the findings of Client's laboratories. It is the Company's sole responsibility to its Client and this document does not constitute an assurance or a guarantee that the results are free from error. All rights and obligations under this document are reserved. This document cannot be reproduced except in full, without prior written consent of the Company. Any unauthorized disclosure, copying, or modification of the content or suppression of this document is subject to legal proceedings and may be prosecuted. Information is not to be disseminated outside the results shown in this test report (this only in the event of) internal and each sample(s) are reserved for 90 days only.

F052 Version 5

SGS Korea Co., Ltd.

322, The Ovalley, 555-a, Hogeje-dong, Dongan-gu, Anyang-si, Gyeonggi-do, Korea 431-050  
 t+82 (0)21 4608 000 f+82 (0)21 4608 000 <http://www.sgslab.co.kr> [www.kr.sgs.com/greenlab](http://www.kr.sgs.com/greenlab)

Member of the SGS Group (Société Générale de Surveillance)

Substance Name	CAS number	EC number	Concentration (%)	Reporting Limit (%)	Classification
1,2-Dichloroethane	107-06-2	203-458-1	N.D.	0.05	Carcinogenic
2,2'-dichloro-4,4'-methylenedianiline (MOCA)	101-14-4	202-918-9	N.D.	0.05	Carcinogenic
2-Methoxyaniline o-Anisidine	90-04-0	201-963-1	N.D.	0.05	Carcinogenic
4-(1,1,3,3-tetramethylbutyl)phenol, (4-tert-Octylphenol)	140-66-9	205-426-2	N.D.	0.05	Equivalent level of concern having probable serious effects to the environment
Aluminosilicate Refractory Ceramic Fibres* (RCF)	650-017-00-8 (Index no.)	-	N.D.	0.005	Carcinogenic
Arsenic acid*	7778-39-4	231-901-9	N.D.	0.005	Carcinogenic
Bis(2-methoxyethyl) ether	111-96-6	203-924-4	N.D.	0.05	Toxic for reproduction
Bis(2-methoxyethyl) phthalate	117-82-8	204-212-6-	N.D.	0.05	Toxic for reproduction
Calcium arsenate*	7778-44-1	231-904-5	N.D.	0.005	Carcinogenic
Dichromium tris(chromate)*	24613-89-6	246-356-2	N.D.	0.005	Carcinogenic
Formaldehyde, oligomeric reaction products with aniline (technical MDA)	25214-70-4	500-036-1	N.D.	0.05	Carcinogenic
Lead diazide*	13424-46-9	236-542-1	N.D.	0.005	Toxic for reproduction
Lead dipicrate*	6477-64-1	229-335-2	N.D.	0.005	Toxic for reproduction
Lead styphnate*	15245-44-0	239-290-2	N.D.	0.005	Toxic for reproduction
N,N-dimethylacetamide (DMAC)	127-19-5	204-826-4	N.D.	0.05	Toxic for reproduction
Pentazinc chromate octahydroxide*	49663-84-5	256-418-0	N.D.	0.005	Carcinogenic
Phenolphthalein	77-09-8	201-004-7	N.D.	0.05	Carcinogenic
Potassium hydroxyoctaoxidincatedichromate*	11103-86-9	234-329-8	N.D.	0.005	Carcinogenic
Trilead diarsenate*	3687-31-8	222-979-5	N.D.	0.005	Carcinogenic Toxic for reproduction
Zirconia Aluminosilicate Refractory Ceramic Fibres (Zr-RCF)*	650-017-00-8 (Index no.)	-	N.D.	0.005	Carcinogenic

This document is issued by the Company subject to its General Conditions of Service printed on sheet, available on request or accessible at <http://www.sgs.com/ServiceConditions.aspx> and, for documents issued electronically, subject to Terms and Conditions for Electronic Documents at <http://www.sgs.com/ServiceConditions.aspx>. Attention is drawn to the limitation of liability, indemnification and jurisdiction clause defined therein. Any holder of this document is advised that information contained herein reflects the Company's findings at the time of its issuance only and will be obsolete if there is any change in the Company's data. The Company's sole responsibility is to the Client and this document does not constitute advice or recommendation from any other party. All rights and obligations under this document are reserved. This document cannot be reproduced, stored in a retrieval system, or transmitted in any form or by any means, electronic, mechanical, photocopying, recording, or otherwise, without the prior written permission of the Company. Any use of this document, in whole or in part, without the prior written permission of the Company is prohibited. All rights reserved. (The information contained herein is for reference only and does not constitute any recommendation or warranty of any kind.)

F052 Version 5

SGS Korea Co., Ltd.

322, The Ovalley, 555-a, Hoge-dong, Dongan-gu, Anyang-si, Gyeonggi-do, Korea 431-050  
t:+82 (0)31 4608 000 f:+82 (0)31 4608 000 <http://www.sgslab.co.kr> [www.kr.sgs.com/guestlab](http://www.kr.sgs.com/guestlab)

Member of the SGS Group (Société Générale de Surveillance)

Substance Name	CAS number	EC number	Concentration (%)	Reporting Limit (%)	Classification
1,2-bis(2-methoxyethoxy)ethane (TEGDME; triglyme)	112-49-2	203-977-3	N.D.	0.05	Toxic for reproduction
1,2-dimethoxyethane;ethylene glycol dimethyl ether (EGDME)	110-71-4	203-794-9	N.D.	0.05	Toxic for reproduction
Diboron trioxide*	1303-86-2	215-125-8	N.D.	0.005	Toxic for reproduction
Formamide	75-12-7	200-842-0	N.D.	0.05	Toxic for reproduction
Lead(II) bis(methanesulfonate)*	17570-76-2	401-750-5	N.D.	0.005	Toxic for reproduction
TGIC(1,3,5-tris(oxiranylmethyl)-1,3,5-triazine-2,4,6-(1H,3H,5H)-trione)	2451-62-9	219-514-3	N.D.	0.05	Mutagenic
β-TGIC (1,3,5-tris[(2S and 2R)-2,3-epoxypropyl]-1,3,5-triazine-2,4,6-(1H,3H,5H)-trione)**	59653-74-6	423-400-0	N.D.	0.05	Mutagenic
4,4'-bis(dimethylamino)benzophenone (Michler's ketone)	90-94-8	202-027-5	N.D.	0.05	Carcinogenic
N,N,N',N'-tetramethyl-4,4'-methylenedianiline (Michler's base)	101-61-1	202-959-2	N.D.	0.05	Carcinogenic
[4-[4,4'-bis(dimethylamino)benzhydrylidene]cyclohexa-2,5-dien-1-ylidene]dimethylammonium chloride (C.I. Basic Violet 3)	548-62-9	208-953-6	N.D.	0.05	Carcinogenic
[4-[[4-anilino-1-naphthyl][4-(dimethylamino)phenyl]methylene]cyclohexa-2,5-dien-1-ylidene]dimethylammonium chloride (C.I. Basic Blue 26)	2580-56-5	219-943-6	N.D.	0.05	Carcinogenic
α,α-Bis[4-(dimethylamino)phenyl]-4(phenylamino)naphthalene-1-methanol (C.I. Solvent Blue 4)	6786-83-0	229-851-8	N.D.	0.05	Carcinogenic
4,4'-bis(dimethylamino)-4''-(methylamino)trityl alcohol	561-41-1	209-218-2	N.D.	0.05	Carcinogenic

This document is issued by the Company subject to the General Conditions of Service printed hereon, available on request or accessible at <http://www.sgs.com/sgs/CompanyConditions.aspx> and its derivatives forms documents subject to Terms and Conditions for Electronic Documents at <http://www.sgs.com/sgs/eDocuments.aspx>. Attention is drawn to the limitation of liability, indemnification and jurisdiction laws defined therein. Any holder of this document is advised that information contained herein reflects the Company's findings at the time of its issue unless otherwise indicated or stated otherwise. The Company's sole responsibility is to its Client and this document does not constitute advice or a guarantee from regarding all the rights and obligations under the applicable law. This document cannot be reproduced except in full without prior written approval of the Company. Any reproduction of this report, in whole or in part, without the express written consent of the Company is prohibited. The information contained in this document is subject to change without notice and the Company shall not be liable for any such change.

F052 Version 5

SGS Korea Co., Ltd.

322, The Ovalley, 555-a, Hageye-dong, Dongan-gu, Anyang-si, Gyeonggi-do, Korea 431-050  
t+82 (0)31 4609 000 f+82 (0)31 4609 000 <http://www.sgsbb.co.kr> [www.kr.sgs.com/greenlab](http://www.kr.sgs.com/greenlab)

Member of the SGS Group (Société Générale de Surveillance)



**Test Report No. F690101/LF-CTSAYAA12-42151** Issued Date: November 30, 2012 Page 9 of 14

**The potential Substances**

Substance Name	CAS number	EC number	Concentration (%)	Reporting Limit (%)	Classification
Bis(pentabromophenyl) ether (DecaBDE)	1163-19-5	214-604-9	N.D.	0.05	PBT vPvB
Pentacosfluorotridecanoic acid	72629-94-8	276-745-2	N.D.	0.05	vPvB
Tricosfluorododecanoic acid	307-55-1	206-203-2	N.D.	0.05	vPvB
Henicosfluoroundecanoic acid	2058-94-8	218-165-4	N.D.	0.05	vPvB
Heptacosfluorotetradecanoic acid	376-06-7	206-803-4	N.D.	0.05	vPvB
4-(1,1,3,3-tetramethylbutyl)phenol, ethoxylated - covering well-defined substances and UVCB substances, polymers and homologues	-	-	N.D.	0.05	Equivalent level of concern - probable serious effects on the environment
4-Nonylphenol, branched and linear - substances with a linear and/or branched alkyl chain with a carbon number of 9 covalently bound in position 4 to phenol, covering also UVCB- and well-defined substances which include any of the individual isomers or a combination thereof	-	-	N.D.	0.05	Equivalent level of concern - probable serious effects on the environment
Diazeno-1,2-dicarboxamide (C,C'-azodi(formamide))	123-77-3	204-650-8	N.D.	0.05	Equivalent level of concern - probable serious effects on human health
Cyclohexane-1,2-dicarboxylic anhydride (Hexahydrophthalic anhydride - HHPA)	85-42-7	201-604-9	N.D.	0.05	Equivalent level of concern - probable serious effects on human health

This document is issued by the Company subject to its General Conditions of Service printed on each analytical report or request or available at <http://www.sgs.com> and for clients' internal use only. It is intended for the client's internal use only. The Company's sole responsibility is to its Client and this document does not constitute an offer of any service or product. The Company's liability is limited to the extent of the contract. This document cannot be reproduced without the written consent of the Company. Any unauthorized alteration, copying or distribution of this document is prohibited and offenders may be prosecuted to the full extent of the law. Other alterations of this report shall be the responsibility of the client and each sample(s) are marked for ID tag's use.

F052 Version 5

SGS Korea Co., Ltd.

322, The Ovalley, 555-s, Hoge-dong, Dongan-gu, Anyang-si, Gyeonggi-do, Korea 431-050  
 t+82 (0)31 4608 000 f+82 (0)31 4608 000 <http://www.sgs.com> [www.kr.sgs.com](http://www.kr.sgs.com) [www.kr.sgs.com/psnlab](http://www.kr.sgs.com/psnlab)

Member of the SGS Group (Société Générale de Surveillance)

Substance Name	CAS number	EC number	Concentration (%)	Reporting Limit (%)	Classification
Hexahydromethylphthalic anhydride, Hexahydro-4-methylphthalic anhydride, Hexahydro-1-methylphthalic anhydride, Hexahydro-3-methylphthalic anhydride	25550-51-0, 19438-60-9, 48122-14-1, 57110-29-9	247-094-1, 243-072-0, 256-356-4, 260-566-1	N.D.	0.05	Equivalent level of concern - probable serious effects on human health
Methoxy acetic acid	625-45-6	210-894-6	N.D.	0.05	Toxic for reproduction equivalent level of concern - probable serious effects on human health and the environment
1,2-Benzenedicarboxylic acid, dipentylester, branched and linear	84777-06-0	284-032-2	N.D.	0.05	Toxic for reproduction
Diisopentylphthalate (DIPP)	605-50-5	210-088-4	N.D.	0.05	Toxic for reproduction
N-pentyl-isopentylphthalate	-	-	N.D.	0.05	Toxic for reproduction
1,2-Diethoxyethane	629-14-1	211-076-1	N.D.	0.05	Toxic for reproduction
N,N-dimethylformamide; dimethyl formamide	68-12-2	200-679-5	N.D.	0.05	Toxic for reproduction
Dibutyltin dichloride (DBT)	683-18-1	211-670-0	N.D.	0.05	Toxic for reproduction
Acetic acid, lead salt, basic*	51404-69-4	257-175-3	N.D.	0.005	Toxic for reproduction
Basic lead carbonate (trilead bis(carbonate)dihydroxide)*	1319-46-6	215-290-6	N.D.	0.005	Toxic for reproduction
Lead oxide sulfate (basic lead sulfate)*	12036-76-9	234-853-7	N.D.	0.005	Toxic for reproduction
[Phthalato(2-)]dioxotrilead (dibasic lead phthalate)*	69011-06-9	273-688-5	N.D.	0.005	Toxic for reproduction

This document is issued by the Company subject to the General Conditions of Service printed on each, available on request or accessible at <http://www.sgs.com/ServiceConditions.aspx> and, for electronic format documents, subject to Terms and Conditions for Electronic Documents at <http://www.sgs.com/ServiceConditions.aspx>. Attention is drawn to the limitation of liability, indemnification and jurisdiction clause defined therein. Any holder of this document is advised that information contained herein reflects the Company's findings within the limit of its internal policy and will be limited to Client's requirements. If any. The Company's sole responsibility is to the Client and this document does not constitute advice or a guarantee. The Company's findings are based on the information provided by the Client and the results of the analysis. Any error or omission in the data or the results of the analysis is the responsibility of the Client. The Company is not responsible for the results of the analysis if the Client provides incorrect or incomplete information. The document cannot be reproduced, stored in a retrieval system, or transmitted in any form or by any means, electronic, mechanical, photocopying, recording, or by any information storage and retrieval system, without prior written permission of the Company. Any unauthorized disclosure, copying, or modification of the content or appearance of this document is prohibited and offenders may be prosecuted to the fullest extent of the law. Unless otherwise stated, the results shown in this test report refer only to the sample(s) tested and each sample(s) are marked for 90 days only.

F052 Version 5

SGS Korea Co., Ltd.

322, The Ovalley, 555-a, Hoge-dong, Dongan-gu, Anyang-si, Gyeonggi-do, Korea 431-050  
 t+82 (0)31 4608 900 f+82 (0)31 4608 099 <http://www.sgslab.co.kr> [www.kr.sgs.com](http://www.kr.sgs.com) [www.kr.sgs.com/guestlab](http://www.kr.sgs.com/guestlab)

Member of the SGS Group (Société Générale de Surveillance)



Substance Name	CAS number	EC number	Concentration (%)	Reporting Limit (%)	Classification
Trilead dioxide phosphonate*	12141-20-7	235-252-2	N.D.	0.005	Toxic for reproduction
Furan	110-00-9	203-727-3	N.D.	0.05	Carcinogenic
Propylene oxide; 1,2-epoxypropane; methyloxirane	75-56-9	200-879-2	N.D.	0.05	Carcinogenic Mutagenic
Diethyl sulphate	64-67-5	200-589-6	N.D.	0.05	Carcinogenic Mutagenic
Dimethyl sulphate	77-78-1	201-058-1	N.D.	0.05	Carcinogenic
3-ethyl-2-methyl-2-(3-methylbutyl)-1,3-oxazolidine	143860-04-2	421-150-7	N.D.	0.05	Toxic for reproduction
Dinoseb	88-85-7	201-861-7	N.D.	0.05	Toxic for reproduction
4,4'-methylenedi-o-toluidine	838-88-0	212-658-8	N.D.	0.05	Carcinogenic
4,4'-oxydianiline and its salts	101-80-4	202-977-0	N.D.	0.05	Carcinogenic Mutagenic
4-Aminoazobenzene; 4-Phenylazoaniline	60-09-3	200-453-6	N.D.	0.05	Carcinogenic
4-methyl-m-phenylenediamine (2,4-toluene-diamine)	95-80-7	202-453-1	N.D.	0.05	Carcinogenic
6-methoxy-m-toluidine (p-cresidine)	120-71-8	204-419-1	N.D.	0.05	Carcinogenic
Biphenyl-4-ylamine	92-67-1	202-177-1	N.D.	0.05	Carcinogenic
o-aminoazotoluene	97-56-3	202-591-2	N.D.	0.05	Carcinogenic
o-Toluidine; 2-Aminotoluene	95-53-4	202-429-0	N.D.	0.05	Carcinogenic
N-methylacetamide	79-16-3	201-182-6	N.D.	0.05	Toxic for reproduction
1-bromopropane; n-propyl bromide	106-94-5	203-445-0	N.D.	0.05	Toxic for reproduction

This document is issued by the Company subject to its General Conditions of Service printed on each report, available on request or accessible at <http://www.sgs.com/ServiceConditions.aspx> and, for electronic format documents, subject to Terms and Conditions for Electronic Documents at <http://www.sgs.com/ServiceConditions.aspx>. Attention is drawn to the limitation of liability, indemnification and jurisdiction clause defined therein. Any holder of this document is advised that the information contained herein reflects the Company's findings with the use of its instruments only and with the limitation of time's intervention. It is the Company's sole responsibility as its Client and this document does not constitute advice or constitute their liability. All rights and obligations under this document are reserved. This document cannot be reproduced, stored in full, without prior written approval of the Company. Any circulation of partial, forged or falsified copies of this document is strictly prohibited and will be prosecuted. Unless otherwise stated, the results shown in this report refer only to the sample(s) tested and each sample is analysed for 30 days only.

F052 Version 5

SGS Korea Co., Ltd.

 322, The Ovalley, 555-a, Hoge-dong, Dongan-gu, Anyang-si, Gyeonggi-do, Korea 431-050  
 t+82 (0)31 4608 000 f+82 (0)31 4608 000 <http://www.sgslab.co.kr> [www.kr.sgs.com/guestlab](http://www.kr.sgs.com/guestlab)

Member of the SGS Group (Società Generale di Sorveglianza)

Note:

1. RL = Reporting Limit
2. N.D. = Not detected (lower than RL)  
NA. = Not applicable for respective material type.

The submitted sample was found to contain significant amount of specific element(s) of SVHC. Upon further test verification and also information provided from client, the possibility that the element(s) content originate from SVHC is very unlikely, even though their presence cannot be exclude entirely. It may be assumed that the detected element(s) have a non-SVHC source.

3. Definition of classification is listed in Appendix A of this report in accordance with 67/548/EEC and Regulation (EC) No 1907/2006. For detail information, Detail explanation is available at the following link:  
<http://echa.europa.eu/web/guest/candidate-list-table> (Candidate list)  
[http://echa.europa.eu/en/web/guest/view-article/-/journal\\_content/512b7526-9dd5-4872-934e-8c298c89ad99](http://echa.europa.eu/en/web/guest/view-article/-/journal_content/512b7526-9dd5-4872-934e-8c298c89ad99) (Potential list)
4. \*.The test result is based on the calculation of selected element(s) / marker(s) and to the worst-case scenario. For detail information, please refer to the SGS REACH website: [www.reach.sgs.com/substance-of-very-high-concern-analysis-information-page.htm](http://www.reach.sgs.com/substance-of-very-high-concern-analysis-information-page.htm)

The client is advised to review the chemical formulation to ascertain above metal substances present in the article.  
 RL = 0.005% is evaluated for element (i.e. cobalt, arsenic, lead, sodium, chromium, chromium(VI), silicon, aluminum, zirconium, boron, and potassium respectively), except molybdenum RL=0.0005%  
 0.1% (w/w) = 1,000 ppm = 1,000 mg/kg

5. \*\* β-TGIC is one of the isomers for TGIC compounds and hence, tested together. The reported test result is based the proposed ratio as according to ECHA dossier.

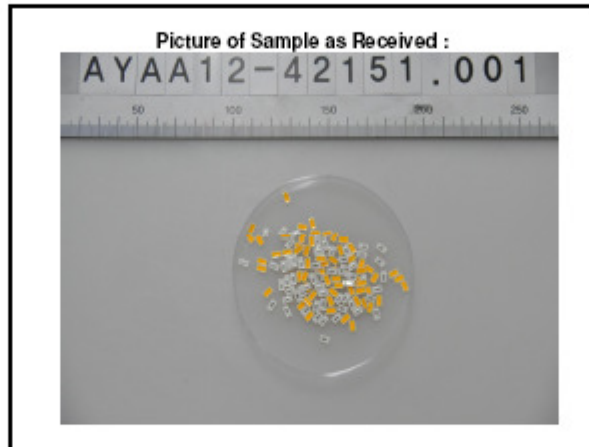

\*\*\* End of Report \*\*\*

This document is issued by the Company subject to its General Conditions of Service printed separately, available on request or accessible at [www.sgs.com](http://www.sgs.com) and [www.sgs.com/sgsweb](http://www.sgs.com/sgsweb). For clients' formal documents, subject to Terms and Conditions for Electronic Documents at [www.sgs.com/sgsweb](http://www.sgs.com/sgsweb). All services are subject to the Client's liability, independence and joint and several liability. Any failure of this document to provide the information requested herein reflects the Company's knowledge at the time of its issue and is not intended to constitute a warranty. The Company's sole responsibility is to its Client and this document does not assume liability in a transaction from acquiring all their rights and obligations under their transaction documents. This document cannot be reproduced except in full without prior written approval of the Company. Any unauthorized alteration, forgery or falsification of the content or appearance of this document is illegal and offenders may be prosecuted accordingly. Member of the SGS Group. Unless otherwise stated, the results shown in this test report refer only to the sample(s) tested and each sample(s) are marked for 30 days only.

## Appendix A

Classification	Definition under 67/548/EEC and Regulation (EC) No 1907/2006
Carcinogen Category 1:	<u>Substances known to be carcinogenic to man.</u> There is sufficient evidence to establish a causal association between human exposure to a substance and the development of cancer.
Carcinogen Category 2:	<u>Substances which should be regarded as if they are carcinogenic to man.</u> There is sufficient evidence to provide a strong presumption that human exposure to a substance may result in the development of cancer. Generally on the basis of: - appropriate long-term animal studies - other relevant information.
Mutagen Category 1:	<u>Substances known to be mutagenic to man.</u> There is sufficient evidence to establish a causal association between human exposure to a substance and heritable genetic damage.
Mutagen Category 2:	<u>Substances which should be regarded as if they are mutagenic to man.</u> There is sufficient evidence to provide a strong presumption that human exposure to the substance may result in the development of heritable genetic damage, generally on the basis of: - appropriate animal studies, - other relevant information.
Toxic to Reproduction Category 1:	<u>Substances known to impair fertility in humans.</u> There is sufficient evidence to establish a causal relationship between human exposure to the substance and impaired fertility. <u>Substances known to cause developmental toxicity in humans.</u> There is sufficient evidence to establish a causal relationship between human exposure to the substance and subsequent developmental toxic effects in the progeny.
Toxic to Reproduction Category 2:	<u>Substances which should be regarded as if they impair fertility in humans.</u> There is sufficient evidence to provide a strong presumption that human exposure to the substance may result in impaired fertility on the basis of: - clear evidence in animal studies of impaired fertility in the absence of toxic effects, or, evidence of impaired fertility occurring at around the same dose levels as other toxic effects but which is not a secondary nonspecific consequence of the other toxic effects, - other relevant information. <u>Substances which should be regarded as if they cause developmental toxicity to humans.</u> There is sufficient evidence to provide a strong presumption that human exposure to the substance may result in developmental toxicity, generally on the basis of: - clear results in appropriate animal studies where effects have been observed in the absence of signs of marked maternal toxicity, or at around the same dose levels as other toxic effects but which are not a secondary non-specific consequence of the other toxic effects, - other relevant information.
PBT & vPvB:	Substances which are persistent, bioaccumulative and toxic (PBT) or very persistent and very bioaccumulative (vPvB) pose a particular challenge to the chemicals safety management. For these substances a "safe" concentration in the environment cannot be established with sufficient reliability.

This document is issued by the Company subject to the General Conditions of Service printed on each, available on request or accessible at <http://www.sgs.com/ServiceConditions.aspx> and, for electronic format documents, subject to Terms and Conditions for Electronic Documents at <http://www.sgs.com/ServiceConditions.aspx>. Attention is drawn to the limitation of liability, indemnification and jurisdiction clauses defined therein. Any holder of this document is advised that the information contained herein reflects the Company's findings at the time of its issuance only and will be limited to the data and information provided to the Company and the Company's own records. The Company's sole responsibility is to its Client and this document does not constitute advice or a guarantee, nor does it constitute any other form of insurance. This document cannot be reproduced or used in full, without prior written approval of the Company. Any use of this document, in whole or in part, for any purpose other than that for which it was prepared is prohibited. Where necessary, the results shown in this report may vary slightly from those reported in the original report due to the use of different methods or equipment used in the laboratory.

F052 Version 5

SGS Korea Co., Ltd.

322, The Ovalley, 555-a, Hogeje-dong, Dongan-gu, Anyang-si, Gyeonggi-do, Korea 431-050  
t +82 (0)31 4608 900 f +82 (0)31 4608 999 <http://www.sgslab.co.kr> [www.kr.sgs.com](http://www.kr.sgs.com) [gsnlab@sgs.com](mailto:gsnlab@sgs.com)

Member of the SGS Group (Société Générale de Surveillance)

Revision History
------------------

Date	No.	Revision History	Writer	
			Drawn	Approved
2013.2.08	001	New version	W.H Jung	Y.T KIM

## Looking for pricing, stock, or lifecycle information?

Click below to explore more details on WIN SOURCE:

- ⊖ [View SPMWHT541MD5WAWHS1 on WIN SOURCE](#)
- ⊖ [Samsung Information](#)

## Optimize Your Supply Chain with WIN SOURCE Solutions

- ✓ Global Sourcing Solution
- ✓ Obsolete Management
- ✓ Cost Control Management
- ✓ Shortage Management
- ✓ Alternative Solution
- ✓ Excess Inventory Management