

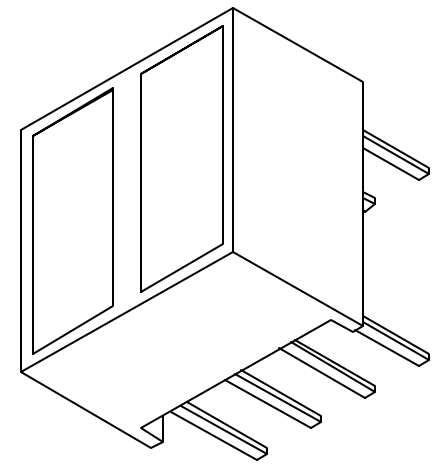

**THE DATASHEET OF
SSB-LX2700YW**

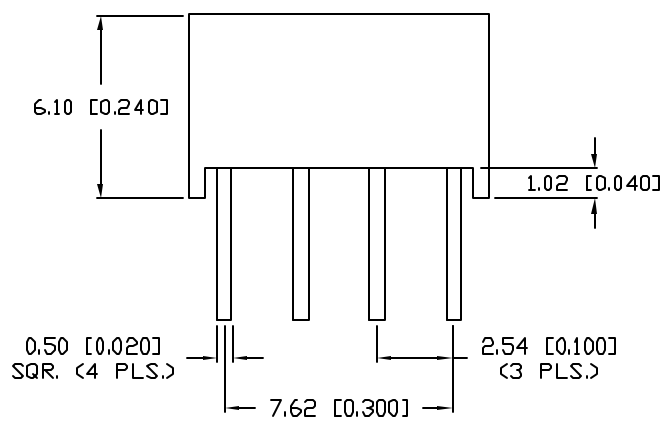

UNCONTROLLED DOCUMENT

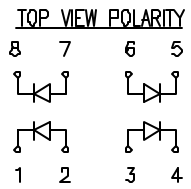
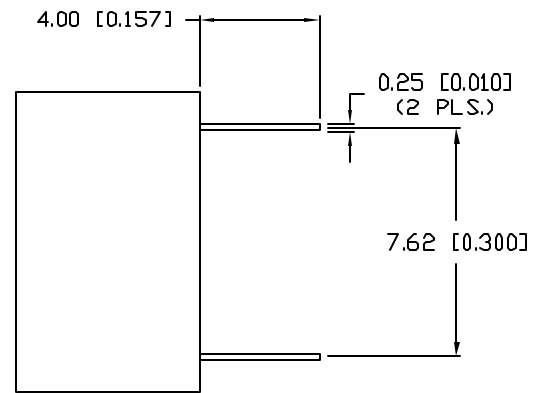
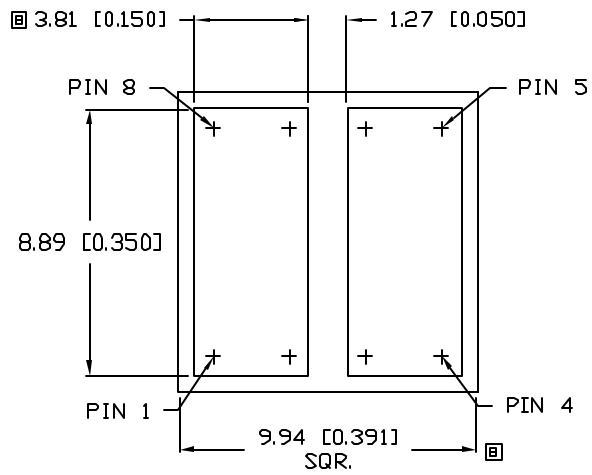

PART NUMBER
SSB-LX2700YW

REV.
C

REV.	E.C.N. NUMBER AND REVISION COMMENTS	DATE
A	E.C.N. #10208.	7.9.96
B	E.C.N. #10241.	9.16.99
C	E.C.N. #10BRDR. & REDRAWN.	6.22.01

ELECTRO-OPTICAL CHARACTERISTICS $T_A=25^\circ\text{C}$ $I_f=20\text{mA}$

PARAMETER	MIN	TYP	MAX	UNITS	TEST COND
PEAK WAVELENGTH		585		nm	
FORWARD VOLTAGE		2.1	2.8	V_f	
REVERSE VOLTAGE	5.0			V_r	$I_f=100\mu\text{A}$
AXIAL INTENSITY		18		mcd	$I_f=20\text{mA}$
VIEWING ANGLE		160		$2x$ theta	
EMITTED COLOR:	YELLOW				
EPOXY LENS FINISH:	MILKY WHITE DIFFUSED				

LIMITS OF SAFE OPERATION AT 25°C PER CHIP

PARAMETER	MAX	UNITS
PEAK FORWARD CURRENT*	150	mA
STEADY CURRENT	30	mA
POWER DISSIPATION	105	mW
DERATE FROM 25°C	-1.2	mW/ $^\circ\text{C}$
OPERATING, STORAGE TEMP.	-40 TO +85	$^\circ\text{C}$
SOLDERING TEMP.	+260	$^\circ\text{C}$
2.0mm FROM BODY		3 SEC. MAX

* $t < 10\mu\text{s}$

*UNLESS OTHERWISE SPECIFIED TOLERANCES PER DECIMAL PRECISION ARE: X=±1 (±0.039), XX=±0.5 (±0.020), XXX=±0.25 (±0.010), XXXX=±0.127 (±0.005). LEAD SIZE=±0.05 (±0.002), LEAD LENGTH=±0.75 (±0.030). MIN.= +DECIMAL PRECISION -0.00 MAX.= +0.00 -DECIMAL PRECISION

UNCONTROLLED DOCUMENT

REV. C	PART NUMBER SSB-LX2700YW
-----------	-----------------------------

CONFIDENTIAL INFORMATION
THE INFORMATION CONTAINED IN THIS DOCUMENT IS THE PROPERTY OF LUMEX INC. EXCEPT AS SPECIFICALLY AUTHORIZED IN WRITING BY LUMEX INC., THE HOLDER OF THIS DOCUMENT SHALL KEEP ALL INFORMATION CONTAINED HEREIN CONFIDENTIAL AND SHALL PROTECT SAME IN WHOLE OR IN PART FROM DISCLOSURE AND DISSEMINATION TO ALL THIRD PARTIES.



290 E. HELEN ROAD
PALATINE, IL 60067-6976
PHONE: +1.847.359.2790
US WEB: www.lumex.com
TW WEB: www.lumex.com.tw



10mm x 10mm SQUARE 2 WINDOW, 4 CHIPS LIGHT BAR,
585nm YELLOW CHIPS, MILKY WHITE DIFFUSED.

RELIABILITY NOTE
OUR MANY YEARS OF EXPERIENCE DATA ACCUMULATION INDICATE THAT SOLDER HEAT IS A MAJOR CAUSE OF EARLY AND FUTURE FAILURE. PLEASE PAY ATTENTION TO YOUR SOLDERING PROCESS.

DRAWN BY: CT	CHECKED BY:	APPROVED BY:	DATE: 4.20.93 PAGE: 1 OF 1 SCALE: N/A
-----------------	-------------	--------------	---

Looking for pricing, stock, or lifecycle information?

Click below to explore more details on WIN SOURCE:

-  [View SSB-LX2700YW on WIN SOURCE](#)
-  [Lumex Opto/Components Inc. Information](#)

Optimize Your Supply Chain with WIN SOURCE Solutions

-  Global Sourcing Solution
-  Obsolete Management
-  Cost Control Management
-  Shortage Management
-  Alternative Solution
-  Excess Inventory Management