

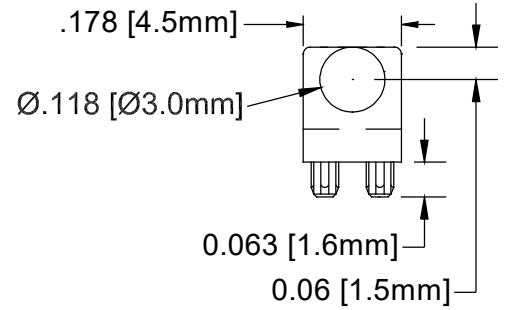

**THE DATASHEET OF
SLP3-150-200-R**

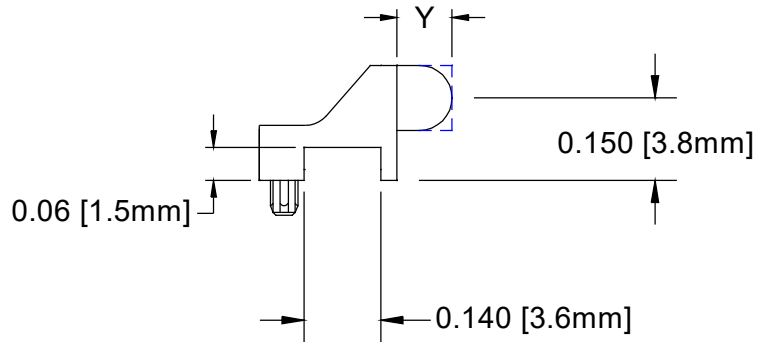

REV.	DESCRIPTION	DATE	APPROVED
K	Added Color Options, Sheet #2	02/02/16	J. C.
L	Created MFG Dwg. Added Peg Chamfer Dimension	07/29/21	A.V.
M	Updated Drawing Dimension Callout	09/16/21	A.V.
N	Updated Recommended Mounting Hole	09/11/23	A.V.



PART NUMBER	Y DIMENSION
SLP3-150-100-F	0.100 [2.54mm] Flat Face
SLP3-150-100-R	0.100 [2.54mm] Round Face
SLP3-150-150-F	0.150 [3.81mm] Flat Face
SLP3-150-150-R	0.150 [3.81mm] Round Face
SLP3-150-200-R	0.200 [5.08mm] Round Face
SLP3-150-250-F	0.250 [6.35mm] Flat Face
SLP3-150-250-R	0.250 [6.35mm] Round Face
SLP3-150-300-F	0.300 [7.62mm] Flat Face
SLP3-150-300-R	0.300 [7.62mm] Round Face
SLP3-150-450-R	0.450 [11.43mm] Round Face

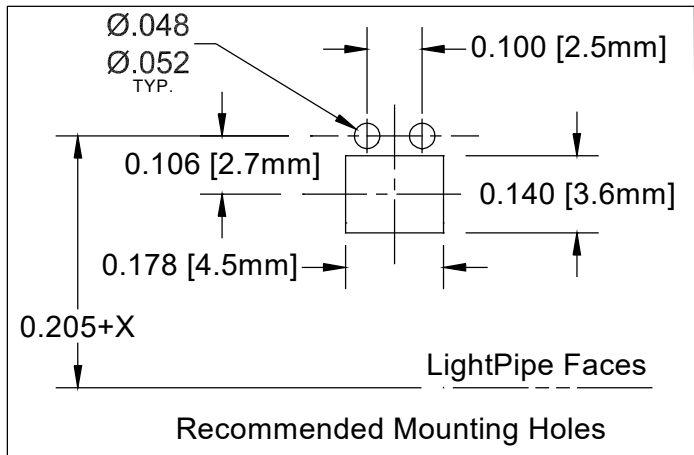
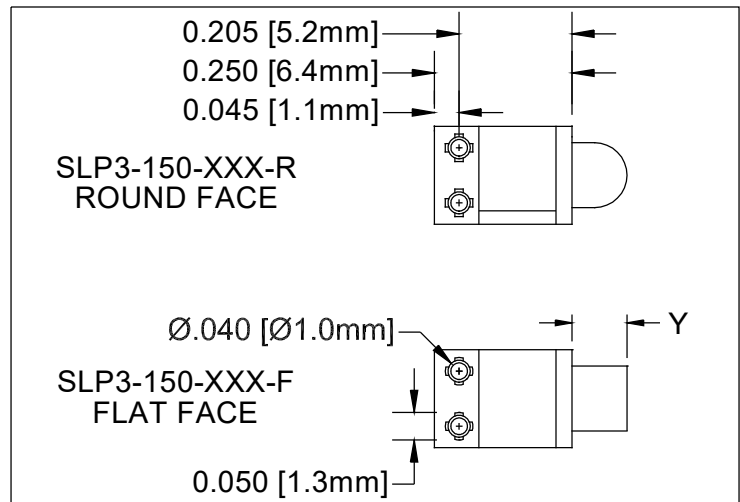

CUSTOMER USE DRAWING

3. ALL DIMENSIONS ARE IN INCHES UNLESS OTHERWISE SPECIFIED
2. MATERIAL: POLYCARBONATE, 94V-0, CLEAR.
1. GENERAL SPECIFICATIONS: BIVAR MOLDED COMPONENT SPECIFICATION BV00-E101.

STANDARD TOLERANCE (UNLESS OTHERWISE SPECIFIED)		BIVAR®	
DECIMALS	ANGULAR	4 THOMAS, IRVINE, CA. 92618	
.X ± .1	X° ± 1°	TEL: (949) 951-8808 FAX: (949) 951-3974	
.XX ± .01		TITLE: LIGHT PIPE	
.XXX ± .005		90° VARIABLE CENTERLINE	
DESIGNED: T. YIN	DATE: 10/17/07	PART NO: SLP3-150-XXX-X	REVISION: N
REVISED: M. PAGDONSOLAN	DATE: 09/11/23	CAGE CODE: 32559	
CHECKED: A. VALDEZ	DATE: 09/11/23	SCALE: 1:1	SHEET # 1 OF 2
CAD GENERATED DOCUMENT, DO NOT MEASURE DRAWING			

REV.	DESCRIPTION	DATE	APPROVED
	See Page #1		

OTHER AVAILABLE COLORS
 * SEE TABLE FOR ORDERING INFORMATION

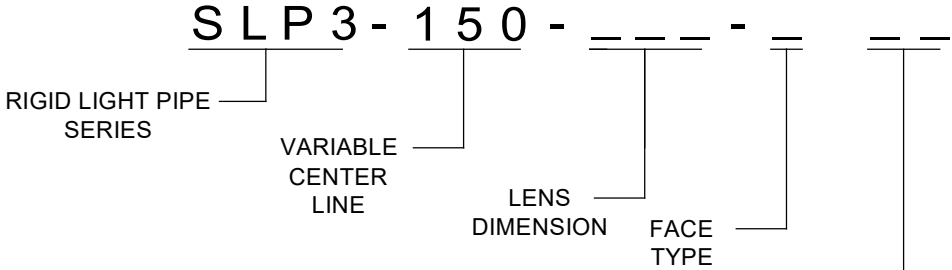

COLOR	Order Code
BLUE	BE
BLACK	BK
GREEN	GN
GRAY	GY
RED	RD
YELLOW	YW

NOTE: LEAVE ORDER CODE BLANK
 IF NO COLOR IS DESIRED.

CUSTOMER USE DRAWING

4. PARTS ARE DYED TO COLOR UPON REQUEST.

		BIVAR[®]	
CAGE CODE	32559	DRAWING NO: SLP3-150-XXX-X	REVISION: N
SHEET SIZE	A	SCALE: N/A	SHEET # 2 OF 2
<small>CAD GENERATED DOCUMENT, DO NOT MEASURE DRAWING</small>			

Looking for pricing, stock, or lifecycle information?

Click below to explore more details on WIN SOURCE:

 [View SLP3-150-200-R on WIN SOURCE](#)

 [Bivar Inc. Information](#)

Optimize Your Supply Chain with WIN SOURCE Solutions

-  Global Sourcing Solution
-  Obsolete Management
-  Cost Control Management
-  Shortage Management
-  Alternative Solution
-  Excess Inventory Management