



THE DATASHEET OF SMFLP5-6.0



NOTES:

1. COMPONENTS SHIPPED NON-ASSEMBLED.

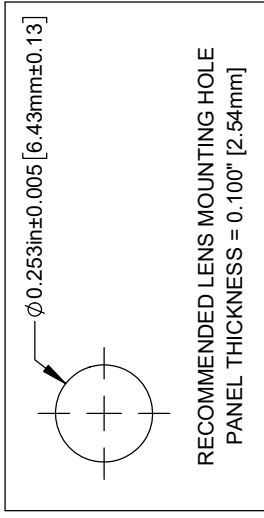
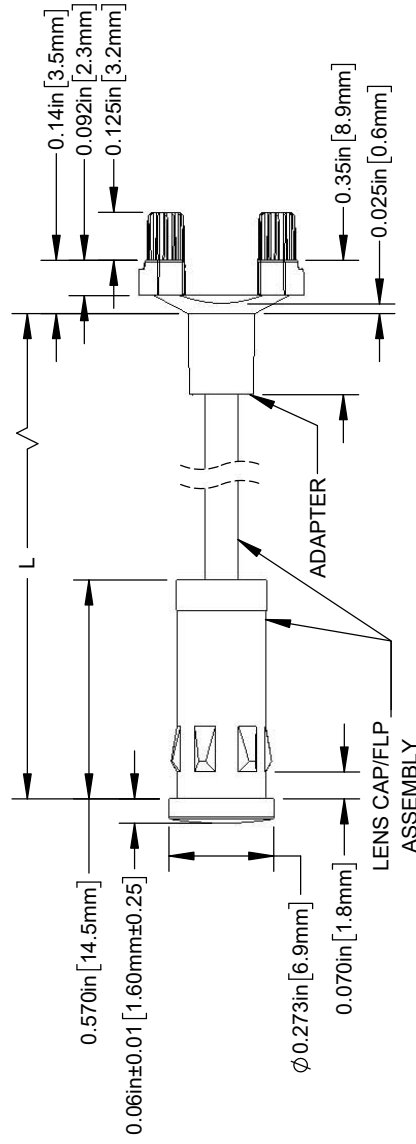
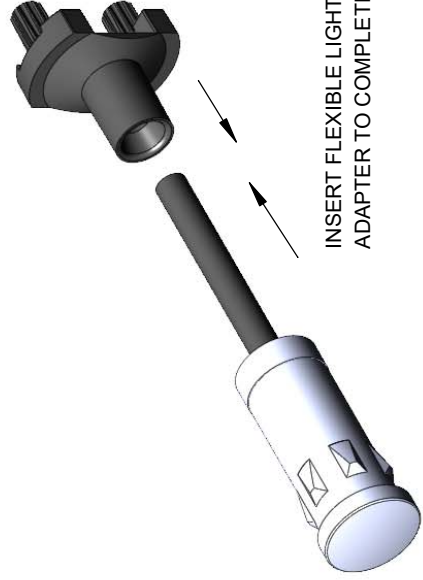

TABLE 1 - LENGTH	
LENGTH (L)*	TOLERANCE
1.00" - 16.00"	±0.05"
16.1" - 40.00"	±0.15"
40.1" - 80.00"	±0.30"
80.1" - 3,940.00"	±0.5%

*AVAILABLE IN 0.1" INCREMENTS



INSERT FLEXIBLE LIGHT PIPE INTO ADAPTER TO COMPLETE ASSEMBLY

REV.	DESCR
A	Engineering Release
B	Updated Table For Length
C	ECO-1241: Updated Reco

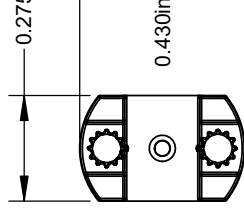

0.	2X $\phi 0.100\text{in}^{+0.000}_{-0.005}$	LED MOUNTING HOLE
		RECOMMENDATIONS & MOUNTING

CUSTOMER

STANDARD TOLERANCE (UNLESS OTHERWISE SPECIFIED)		ANGULAR	
DECIMALS	X° ± 1°		
.X	±.1	DATE:	7/8/2008
.XX	±.02	DESIGNED:	B. OLIVER
.XXX	±.010	REVISOR:	K. BARON
		CHECKED:	A. VALDEZ
		DATE:	4/24/2022

Looking for pricing, stock, or lifecycle information?

Click below to explore more details on WIN SOURCE:

 [View SMFLP5-6.0 on WIN SOURCE](#)

 [Bivar Inc. Information](#)

Optimize Your Supply Chain with WIN SOURCE Solutions

-  Global Sourcing Solution
-  Obsolete Management
-  Cost Control Management
-  Shortage Management
-  Alternative Solution
-  Excess Inventory Management