



**THE DATASHEET OF
SQ24T10050-PEC0G**



SQ24 Series

Eighth-Brick DC-DC Converter

The SemiQ™ Family of DC-DC converters provides a high efficiency single output in a size that is only 60% of industry-standard quarter-bricks, while preserving the same pinout and functionality.

In high temperature environments, for output voltages ranging from 3.3 V to 1.0 V, the thermal performance of SemiQ™ converters exceeds that of most competitors' 20 -30 A quarter-bricks. This is accomplished through the use of patent pending circuit, packaging and processing techniques to achieve ultra-high efficiency, excellent thermal management and a very low body profile.

Low body profile and the preclusion of heat sinks minimize airflow shadowing, thus enhancing cooling for downstream devices. The use of 100% automation for assembly, coupled with advanced electric and thermal design, results in a product with extremely high reliability.

Operating from an 18-36 V input, the SQ24 Series converters of the SemiQ™ Family provide any standard output voltage from 12 V down to 1.0 V. Outputs can be trimmed from -20% to +10% of the nominal output voltage ($\pm 10\%$ for output voltages 1.2 V and 1.0 V), thus providing outstanding design flexibility.

With a standard pinout and trim equations, the SQ24 Series converters are perfect drop-in replacements for existing quarter brick designs. Inclusion of this converter in new designs can result in significant board space and cost savings. The device is also available in a surface mount package.

In both cases the designer can expect reliability improvement over other available converters because of the SQ24 Series' optimized thermal efficiency.

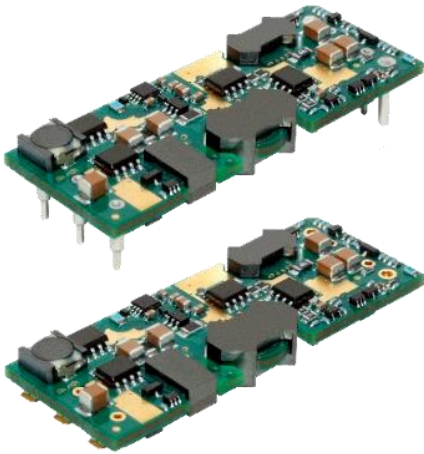

Key Features & Benefits

- 18-36 VDC Input; Outputs from 1-12 VDC
- Available in through-hole and SM packages
- Outputs available in 12.0, 8.0, 6.0, 5.0, 3.3, 2.5, 2.0, 1.8, 1.5, 1.2 & 1.0 V
- High efficiency – no heat sink required
- On-board input differential LC-filter
- Extremely low output and input ripple
- Start-up into pre-biased output
- No minimum load required
- Fixed-frequency operation
- Fully protected
- Remote output sense
- Output voltage trim range: +10%/–20% (except 1.2 V and 1.0 V outputs with trim range $\pm 10\%$) with industry standard trim equations
- High reliability: MTBF of 3.4 million hours, calculated per Telcordia TR-332, Method I Case 1
- Positive or negative logic ON/OFF option
- All materials meet UL94, V-0 flammability rating
- Approved to the latest edition and amendment of ITE Safety standards, UL/CSA 60950-1 and IEC60950-1
- RoHS lead-free solder and lead-solder-exempted products are available

1 ELECTRICAL SPECIFICATIONS

Conditions: $T_A = 25\text{ }^\circ\text{C}$, Airflow = 300 LFM (1.5 m/s), $V_{in} = 24\text{ VDC}$, All output voltages, unless otherwise specified.

PARAMETER	NOTES	MIN	TYP	MAX	UNITS
Absolute Maximum Ratings					
Input Voltage	Continuous	0		40	VDC
Operating Ambient Temperature		-40		85	$^\circ\text{C}$
Storage Temperature		-55		125	$^\circ\text{C}$
Input Characteristics					
Operating Input Voltage Range		18	24	36	VDC
Input Under Voltage Lockout (Non-latching)	Turn-on Threshold	16	17	17.5	VDC
	Turn-off Threshold	15	16	16.5	VDC
Isolation Characteristics					
I/O Isolation		2000			VDC
Isolation Capacitance	1.0 - 3.3 V		160		pF
	5.0 - 6.0 V		260		pF
	8.0 V, 12 V		230		pF
Isolation Resistance		10			M Ω
Feature Characteristics					
Switching Frequency			415		kHz
Output Voltage Trim Range ¹	Industry-std. equations (1.5 - 12 V)	-20		+10	%
	Industry-std. equations (1.0 - 1.2 V)	-10		+10	%
Remote Sense Compensation ¹	Percent of $V_{OUT}(NOM)$			+10	%
Output Over-Voltage Protection	Non-latching (1.5 - 12 V)	117	125	140	%
	Non-latching (1.0 - 1.2 V)	124	132	140	%
Auto-Restart Period	Applies to all protection features		100		ms
Turn-On Time			4		ms
ON/OFF Control (Positive Logic)	Converter Off	-20		0.8	VDC
	Converter On	2.4		20	VDC
ON/OFF Control (Negative Logic)	Converter Off	2.4		20	VDC
	Converter On	-20		0.8	VDC

¹ V_{out} can be increased up to 10% via the sense leads or up to 10% via the trim function, however total output voltage trim from all sources should not exceed 10% of $V_{OUT}(NOM)$, in order to insure specified operation of over-voltage protection circuitry. See "Output Voltage Adjust/Trim" for detailed information.

2 OPERATIONS

2.1 INPUT AND OUTPUT IMPEDANCE

These power converters have been designed to be stable with no external capacitors when used in low inductance input and output circuits.

However, in many applications, the inductance associated with the distribution from the power source to the input of the converter can affect the stability of the converter. The addition of a 100 μF electrolytic capacitor with an ESR < 1 across the input helps ensure stability of the converter. In many applications, the user has to use decoupling capacitance at the load. The power converter will exhibit stable operation with external load capacitance up to 1000 μF on 12 V, 2,200 μF on 8.0 V, 10,000 μF on 5.0 V – 6.0 V, and 15,000 μF on 3.3 V – 1.0 V outputs.

2.2 ON/OFF (Pin 2)

The ON/OFF pin is used to turn the power converter on or off remotely via a system signal. There are two remote control options available, positive logic and negative logic and both are referenced to $V_{in(-)}$. Typical connections are shown in Fig. A.

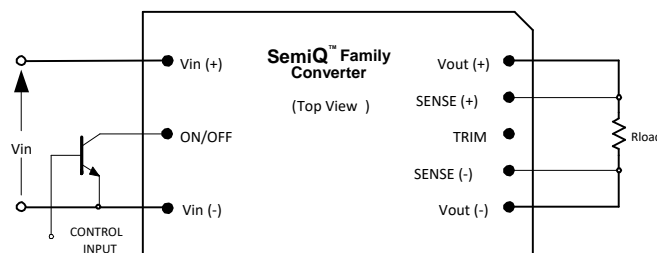

Fig. A: Circuit configuration for ON/OFF function.

The positive logic version turns on when the ON/OFF pin is at logic high and turns off when at logic low. The converter is on when the ON/OFF pin is left open.

The negative logic version turns on when the pin is at logic low and turns off when the pin is at logic high. The ON/OFF pin can be hard wired directly to $V_{in(-)}$ to enable automatic power up of the converter without the need of an external control signal.

ON/OFF pin is internally pulled-up to 5 V through a resistor. A mechanical switch, open collector transistor, or FET can be used to drive the input of the ON/OFF pin. The device must be capable of sinking up to 0.2mA at a low level voltage of 0.8V. An external voltage source ($\pm 20\text{V}$ maximum) may be connected directly to the ON/OFF input, in which case it must be capable of sourcing or sinking up to 1mA depending on the signal polarity. See the Start-up Information section for system timing waveforms associated with use of the ON/OFF pin.

2.3 REMOTE SENSE (PINS 5 AND 7)

The remote sense feature of the converter compensates for voltage drops occurring between the output pins of the converter and the load. The SENSE(-) (Pin 5) and SENSE(+) (Pin 7) pins should be connected at the load or at the point where regulation is required (see Fig. B).

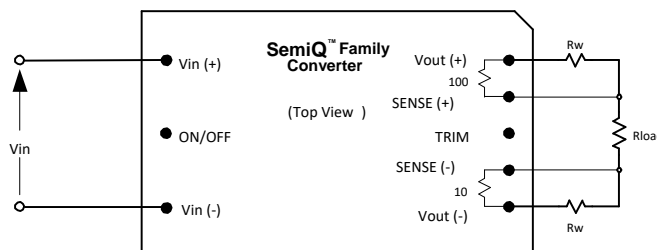

Fig. B: Remote sense circuit configuration.

If remote sensing is not required, the SENSE(-) pin must be connected to the Vout(-) pin (Pin 4), and the SENSE(+) pin must be connected to the Vout(+) pin (Pin 8) to ensure the converter will regulate at the specified output voltage. If these connections are not made, the converter will deliver an output voltage that is slightly higher than the specified value.

Because the sense leads carry minimal current, large traces on the end-user board are not required. However, sense traces should be located close to a ground plane to minimize system noise and insure optimum performance. When wiring discretely, twisted pair wires should be used to connect the sense lines to the load to reduce susceptibility to noise.

The converter's output over-voltage protection (OVP) senses the voltage across Vout(+) and Vout(-), and not across the sense lines, so the resistance (and resulting voltage drop) between the output pins of the converter and the load should be minimized to prevent unwanted triggering of the OVP.

When utilizing the remote sense feature, care must be taken not to exceed the maximum allowable output power capability of the converter, equal to the product of the nominal output voltage and the allowable output current for the given conditions.

When using remote sense, the output voltage at the converter can be increased by as much as 10% above the nominal rating in order to maintain the required voltage across the load. Therefore, the designer must, if necessary, decrease the maximum current (originally obtained from the derating curves) by the same percentage to ensure the converter's actual output power remains at or below the maximum allowable output power.

2.4 OUTPUT VOLTAGE ADJUST/TRIM (PIN 6)

The converter's output voltage can be adjusted up 10% or down 20% for $V_{out} \geq 1.5V$, and $\pm 10\%$ for $V_{out} = 1.2V$ and $1.0V$, relative to the rated output voltage by the addition of an externally connected resistor. For output voltages $3.3V$, trim up to 10% is guaranteed only at $V_{in} \geq 20V$, and it is marginal (8% to 10%) at $V_{in} = 18V$ depending on load current.

The TRIM pin should be left open if trimming is not being used. To minimize noise pickup, a $0.1 \mu F$ capacitor is connected internally between the TRIM and SENSE(-) pins.

To increase the output voltage, refer to Fig. C. A trim resistor, R_{T-INCR} , should be connected between the TRIM (Pin 6) and SENSE(+) (Pin 7), with a value of:

$$R_{T-INCR} = \frac{5.11(100 + \Delta)V_{O-NOM} - 626}{1.225\Delta} - 10.22 \quad [k\Omega] (1.5-12 V)$$

$$R_{T-INCR} = \frac{485}{\Delta} \quad [k\Omega] (1.2 V)$$

$$R_{T-INCR} = \frac{323}{\Delta} - 2 \quad [k\Omega] (1.0 V)$$

where,

R_{T-INCR} = Required value of trim-up resistor [k Ω]

V_{O-NOM} = Nominal value of output voltage [V]

$$\Delta = \left| \frac{(V_{O-REQ} - V_{O-NOM})}{V_{O-NOM}} \right| \times 100 \quad [\%]$$

V_{O-REQ} = Desired (trimmed) output voltage [V].

When trimming up, care must be taken not to exceed the converter's maximum allowable output power. See previous section for a complete discussion of this requirement.

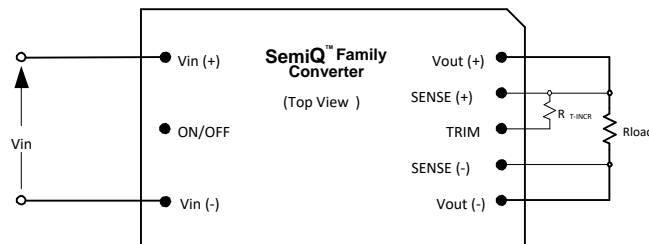

Fig. C: Configuration for increasing output voltage.

To decrease the output voltage (Fig. D), a trim resistor, R_{T-DECR} , should be connected between the TRIM (Pin 6) and SENSE(-) (Pin 5), with a value of:

$$R_{T-DECR} = \frac{511}{|\Delta|} - 10.22 \quad [\text{k}\Omega] \quad (1.0 - 12 \text{ V})$$

where,

R_{T-DECR} = Required value of trim-down resistor [kΩ] and Δ is defined above.

Note: The above equations for calculation of trim resistor values match those typically used in conventional industry standard quarter bricks and one-eighth bricks.

Converters with output voltage 1.2V and 1.0V have specific trim schematic and equations, to provide the customers with the flexibility of second sourcing. For these converters, the last character of part number is "T". More information about trim feature, including corresponding schematic portions, can be found in Application Note 103.

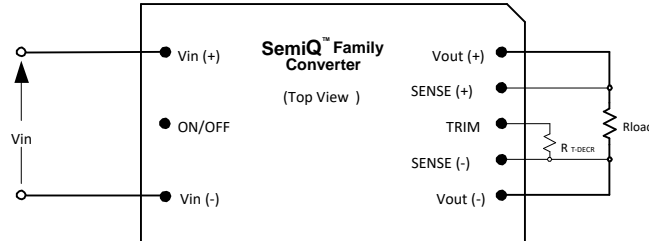

Fig. D: Configuration for decreasing output voltage.

Trimming/sensing beyond 110% of the rated output voltage is not an acceptable design practice, as this condition could cause unwanted triggering of the output over-voltage protection (OVP) circuit. The designer should ensure that the difference between the voltages across the converter's output pins and its sense pins does not exceed 10% of

$V_{OUT(NOM)}$, or:

$$[V_{OUT(+)} - V_{OUT(-)}] - [V_{SENSE(+)} - V_{SENSE(-)}] \leq V_{O-NOM} \times 10\% \quad [V]$$

This equation is applicable for any condition of output sensing and/or output trim.

3 PROTECTION FEATURES

3.1 INPUT UNDERVOLTAGE LOCKOUT

Input undervoltage lockout is standard with this converter. The converter will shut down when the input voltage drops below a pre-determined voltage.

The input voltage must be at least 17.5V for the converter to turn on. Once the converter has been turned on, it will shut off when the input voltage drops below 15V. This feature is beneficial in preventing deep discharging of batteries used in telecom applications.

3.2 OUTPUT OVERCURRENT PROTECTION (OCP)

The converter is protected against overcurrent or short circuit conditions. Upon sensing an overcurrent condition, the converter will switch to constant current operation and thereby begin to reduce output voltage. When the output voltage drops below 50% of the nominal value of output voltage, the converter will shut down.

Once the converter has shut down, it will attempt to restart nominally every 100 ms with a typical 1-2% duty cycle. The attempted restart will continue indefinitely until the overload or short circuit conditions are removed or the output voltage rises above 50% of its nominal value.

3.3 OUTPUT OVERVOLTAGE PROTECTION (OVP)

The converter will shut down if the output voltage across $V_{out}(+)$ (Pin 8) and $V_{out}(-)$ (Pin 4) exceeds the threshold of the OVP circuitry. The OVP circuitry contains its own reference, independent of the output voltage regulation loop. Once the converter has shut down, it will attempt to restart every 100 ms until the OVP condition is removed.

3.4 OVERTEMPERATURE PROTECTION (OTP)

The converter will shut down under an overtemperature condition to protect itself from overheating caused by operation outside the thermal derating curves, or operation in abnormal conditions such as system fan failure. After the converter has cooled to a safe operating temperature, it will automatically restart.

3.5 SAFETY REQUIREMENTS

The converters meet the requirements of the latest edition and amendment of ITE Safety standards UL/CSA 60950-1.

Basic Insulation is provided between input and output. To comply with safety agencies requirements, an input line fuse must be used external to the converter. The table below provides the recommended fuse rating for use with this family of products.

OUTPUT VOLTAGE	FUSE RATING
3.3 V	8 A
12 V - 5.0 V, 2.5 V	6 A
2.0 V - 1.0 V	4 A

If one input fuse is used for a group of modules, the maximum fuse rating should not exceed 15-A (SQ modules are UL approved with up to a 15-A fuse).

3.6 ELECTROMAGNETIC COMPATIBILITY (EMC)

EMC requirements must be met at the end-product system level, as no specific standards dedicated to EMC characteristics of board mounted component dc-dc converters exist. However, Bel Power Solutions tests its converters to several system level standards, primary of which is the more stringent EN55022, Information technology equipment - Radio disturbance characteristics - Limits and methods of measurement.

With the addition of a simple external filter (see application notes), all versions of the SQ24 Series of converters pass the requirements of Class B conducted emissions per EN55022 and FCC, and meet at a minimum, Class A radiated emissions per EN 55022 and Class B per FCC Title 47CFR, Part 15-J. Please contact di/dt Applications Engineering for details of this testing.

4 CHARACTERIZATION

4.1 GENERAL INFORMATION

The converter has been characterized for many operational aspects, to include thermal derating (maximum load current as a function of ambient temperature and airflow) for vertical and horizontal mounting, efficiency, start-up and shutdown parameters, output ripple and noise, transient response to load step-change, overload and short circuit.

The figures are numbered as Fig. x.y, where x indicates the different output voltages, and y is associated with a specific plot (y = 1 for the vertical thermal derating, ...). For example, Fig. x.1 will refer to the vertical thermal derating for all the output voltages in general.

The following pages contain specific plots or waveforms associated with the converter. Additional comments for specific data are provided below.

4.2 TEST CONDITIONS

All data presented were taken with the converter soldered to a test board, specifically a 0.060" thick printed wiring board (PWB) with four layers. The top and bottom layers were not metalized. The two inner layers, comprising two-ounce copper, were used to provide traces for connectivity to the converter.

The lack of metalization on the outer layers as well as the limited thermal connection ensured that heat transfer from the converter to the PWB was minimized. This provides a worst-case but consistent scenario for thermal derating purposes.

All measurements requiring airflow were made in vertical and horizontal wind tunnel facilities using Infrared (IR) thermography and thermocouples for thermometry.

Ensuring components on the converter do not exceed their ratings is important to maintaining high reliability. If one anticipates operating the converter at or close to the maximum loads specified in the derating curves, it is prudent to check actual operating temperatures in the application. Thermographic imaging is preferable; if this capability is not available, then thermocouples may be used. Bel Power Solutions recommends the use of AWG #40 gauge thermocouples to ensure measurement accuracy. Careful routing of the thermocouple leads will further minimize measurement error. Refer to Figure H for optimum measuring thermocouple location.

4.3 THERMAL DERATING

Load current vs. ambient temperature and airflow rates are given in Fig. x.1 for through-hole version. Ambient temperature was varied between 25 °C and 85 °C, with airflow rates from 30 to 500 LFM (0.15 to 2.5 m/s), and vertical and horizontal converter mounting.

For each set of conditions, the maximum load current was defined as the lowest of:

- (i) The output current at which any FET junction temperature did not exceed a maximum specified temperature (120 °C) as indicated by the thermographic image, or
- (ii) The nominal rating of the converter (4 A on 12 V, 5.3 A on 8.0 V, 8 A on 6.0 V, 10 A on 5.0 V, and 15 A on 3.3 – 1.0 V).

During normal operation, derating curves with maximum FET temperature less than or equal to 120 °C should not be exceeded. Temperature on the PCB at the thermocouple location shown in Fig. H should not exceed 118 °C in order to operate inside the derating curves.



Fig. H: Location of the thermocouple for thermal testing.

4.4 EFFICIENCY

Fig. x.5 shows the efficiency vs. load current plot for ambient temperature of 25 °C, airflow rate of 300 LFM (1.5 m/s) with vertical mounting and input voltages of 18 V, 24 V and 36 V. Also, a plot of efficiency vs. load current, as a function of ambient temperature with $V_{in} = 24$ V, airflow rate of 200 LFM (1 m/s) with vertical mounting is shown in Fig. x.6.

4.5 POWER DISSIPATION

Fig. x.7 shows the power dissipation vs. load current plot for $T_a = 25$ °C, airflow rate of 300 LFM (1.5 m/s) with vertical mounting and input voltages of 18 V, 24 V and 36 V. Also, a plot of power dissipation vs. load current, as a function of ambient temperature with $V_{in} = 24$ V, airflow rate of 200 LFM (1 m/s) with vertical mounting is shown in Fig. x.8.

4.6 START-UP

Output voltage waveforms, during the turn-on transient using the ON/OFF pin for full rated load currents (resistive load) are shown without and with external load capacitance in Fig. x.9 and Fig. x.10, respectively.

4.7 RIPPLE AND NOISE

Fig. x.13 shows the output voltage ripple waveform, measured at full rated load current with a 10 μ F tantalum and 1 μ F ceramic capacitor across the output. Note that all output voltage waveforms are measured across a 1 μ F ceramic capacitor.

The input reflected ripple current waveforms are obtained using the test setup shown in Fig x.14. The corresponding waveforms are shown in Fig. x.15 and Fig. x.16.

4.8 START-UP INFORMATION (USING NEGATIVE ON/OFF)

Scenario #1: Initial Start-up From Bulk Supply

ON/OFF function enabled, converter started via application of V_{IN} . See Figure E.

Time	Comments
t_0	ON/OFF pin is ON; system front end power is toggled on, V_{IN} to converter begins to rise.
t_1	V_{IN} crosses Under-Voltage Lockout protection circuit threshold; converter enabled.
t_2	Converter begins to respond to turn-on command (converter turn-on delay).
t_3	Converter V_{OUT} reaches 100% of nominal value.

For this example, the total converter start-up time ($t_3 - t_1$) is typically 4 ms.



Fig. E: Start-up scenario #1

Scenario #2: Initial Start-up Using ON/OFF Pin

With V_{IN} previously powered, converter started via ON/OFF pin. See Figure F.

Time	Comments
t_0	V_{INPUT} at nominal value.
t_1	Arbitrary time when ON/OFF pin is enabled (converter enabled).
t_2	End of converter turn-on delay.
t_3	Converter V_{OUT} reaches 100% of nominal value.

For this example, the total converter start-up time ($t_3 - t_1$) is typically 4 ms.



Fig. F: Start-up scenario #2.

Scenario #3: Turn-off and Restart Using ON/OFF Pin

With V_{IN} previously powered, converter is disabled and then enabled via ON/OFF pin. See Figure G.

Time	Comments
t_0	V_{IN} and V_{OUT} are at nominal values; ON/OFF pin ON.
t_1	ON/OFF pin arbitrarily disabled; converter output falls to zero; turn-on inhibit delay period (100 ms typical) is initiated, and ON/OFF pin action is internally inhibited. t_2 ON/OFF pin is externally re-enabled.
	If $(t_2 - t_1) \leq 100$ ms , external action of ON/OFF pin is locked out by start-up inhibit timer.
	If $(t_2 - t_1) > 100$ ms , ON/OFF pin action is internally enabled.
t_3	Turn-on inhibit delay period ends. If ON/OFF pin is ON, converter begins turn-on; if off, converter awaits ON/OFF pin ON signal; see Figure F. t_4 End of converter turn-on delay.
t_5	Converter V_{OUT} reaches 100% of nominal value. For the condition, $(t_2 - t_1) \leq 100$ ms, the total converter start-up time ($t_5 - t_2$) is typically 104 ms. For $(t_2 - t_1) > 100$ ms, start-up will be typically 4 ms after release of ON/OFF pin.



Fig. G: Start-up scenario #3

5 ELECTRICAL SPECIFICATIONS: SQ24T/S04120 (12 VOLTS OUT)

Conditions: T_A = 25°C, Airflow = 300 LFM (1.5 m/s), V_{in} = 24 VDC, V_{out} = 12 VDC unless otherwise specified.

PARAMETER	NOTES	MIN	TYP	MAX	UNITS
Input Characteristics					
Maximum Input Current	4 ADC, 12 VDC Out @ 18 VDC In			3.1	ADC
Input Stand-by Current	V _{in} = 24 V, converter disabled		3		mADC
Input No Load Current (0 load on the output)	V _{in} = 24 V, converter enabled		100		mADC
Input Reflected-Ripple Current	25 MHz bandwidth		6		mA _{PK-PK}
Input Voltage Ripple Rejection	120 Hz		TBD		dB
Output Characteristics					
Output Voltage Set Point (no load)		11.88	12.00	12.12	VDC
Output Regulation	Over Line		±4	±10	mV
	Over Load		±4	±10	mV
Output Voltage Range	Over line, load and temperature (-40°C to 85°C)	11.82		12.18	VDC
Output Ripple and Noise - 25 MHz bandwidth	Full load + 10 µF tantalum + 1 µF ceramic		90	120	mV _{PK-PK}
External Load Capacitance	Plus full load (resistive)			1000	µF
Output Current Range		0		4	ADC
Current Limit Inception	Non-latching		5	5.5	ADC
Peak Short-Circuit Current	Non-latching. Short = 10 mΩ.		7.5	10	A
RMS Short-Circuit Current	Non-latching			1	Arms
Dynamic Response					
Load Change 25% of I _{out} Max, di/dt = 0.1 A/µs	Co = 1 µF ceramic		150		mV
	di/dt = 5 A/µs 1 µF ceramic		200		mV
Setting Time to 1%			20		µs
Efficiency					
100% Load			87		%
50% Load			87		%



Fig. 12V.1: Available load current vs. ambient air temperature and airflow rates for SQ24T04120 converter with B height pins mounted vertically with $V_{in} = 24V$, air flowing from pin 3 to pin 1 and maximum FET temperature $\leq 120^{\circ}C$.

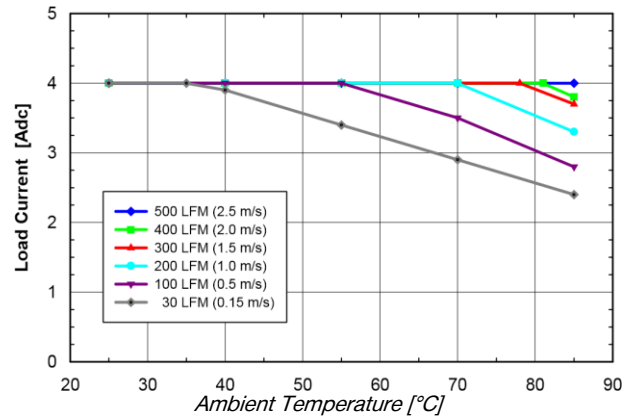

Fig. 12V.2: Available load current vs. ambient air temperature and airflow rates for SQ24T04120 converter with B height pins mounted horizontally with $V_{in} = 24V$, air flowing from pin 3 to pin 1 and maximum FET temperature $\leq 120^{\circ}C$.

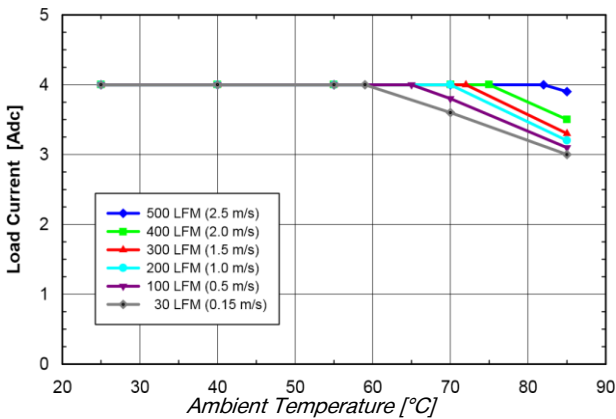

Fig. 12V.3: Available load current vs. ambient temperature and airflow rates for SQ24S04120 converter mounted vertically with $V_{in} = 24V$, air flowing from pin 3 to pin 1 and maximum FET temperature $\leq 120^{\circ}C$.

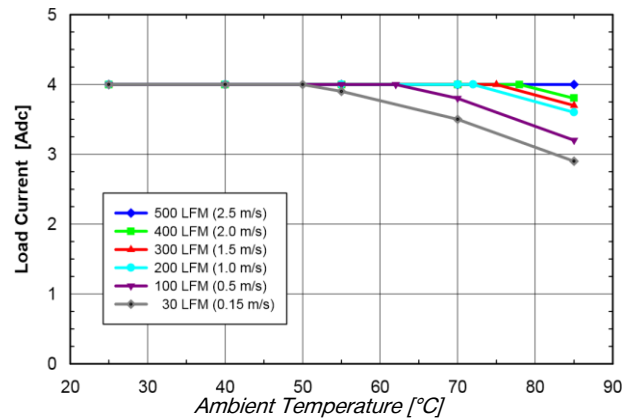

Fig. 12V.4: Available load current vs. ambient temperature and airflow rates for SQ24S04120 converter mounted horizontally with $V_{in} = 24V$, air flowing from pin 3 to pin 1 and maximum FET temperature $\leq 120^{\circ}C$.

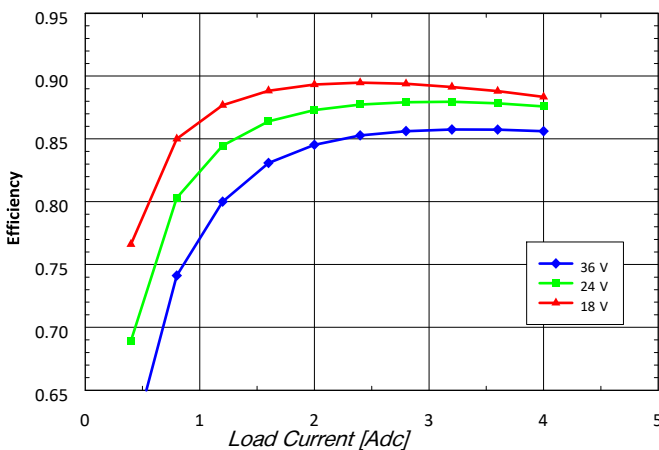

Fig. 12V.5: Efficiency vs. load current and input voltage for SQ24T/S04120 converter mounted vertically with air flowing from pin 3 to pin 1 at a rate of 300 LFM (1.5 m/s) and $T_a = 25^{\circ}C$.

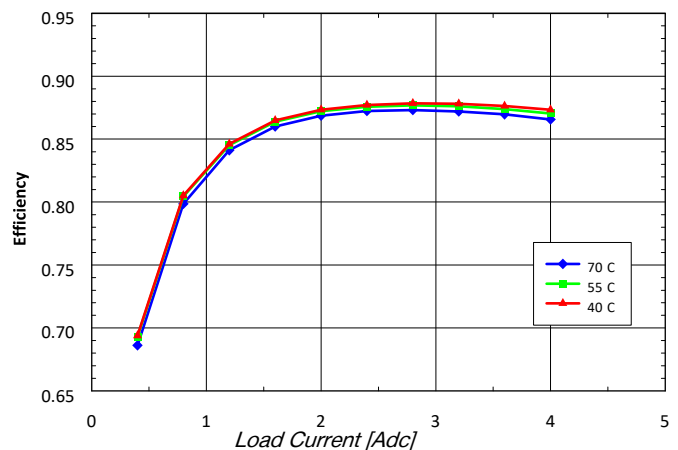

Fig. 12V.6: Efficiency vs. load current and ambient temperature for SQ24T/S04120 converter mounted vertically with $V_{in} = 24V$ and air flowing from pin 3 to pin 1 at a rate of 200 LFM (1.0 m/s).



Fig. 12V.7: Power dissipation vs. load current and input voltage for SQ24T/S04120 converter mounted vertically with air flowing from pin 3 to pin 1 at a rate of 300 LFM (1.5 m/s) and $T_a = 25^\circ\text{C}$.



Fig. 12V.8: Power dissipation vs. load current and ambient temperature for SQ24T/S04120 converter mounted vertically with $V_{in} = 24\text{V}$ and air flowing from pin 3 to pin 1 at a rate of 200 LFM (1.0 m/s).

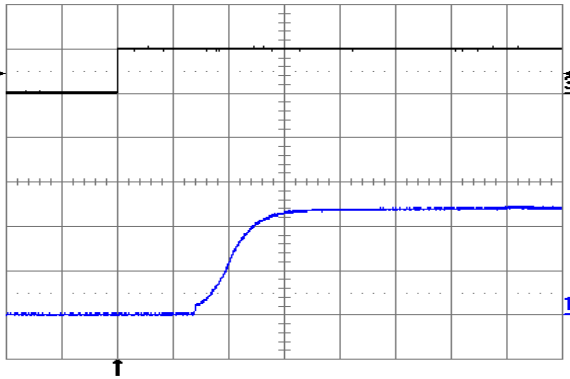

Fig. 12V.9: Turn-on transient at full rated load current (resistive) with no output capacitor at $V_{in} = 24\text{V}$, triggered via ON/OFF pin. Top trace: ON/OFF signal (5 V/div.). Bottom trace: output voltage (5 V/div.). Time scale: 1 ms/div.

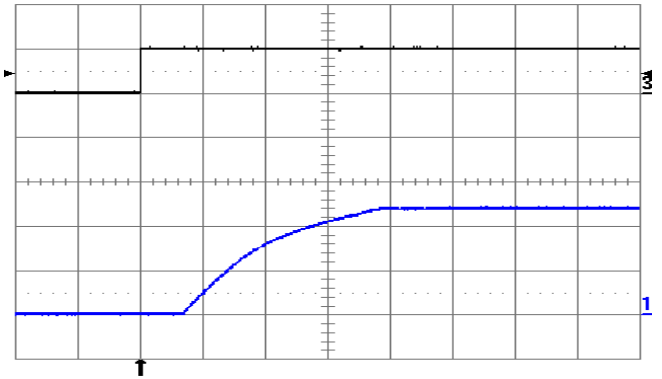

Fig. 12V.10: Turn-on transient at full rated load current (resistive) plus 1,000µF at $V_{in} = 24\text{V}$, triggered via ON/OFF pin. Top trace: ON/OFF signal (5 V/div.). Bottom trace: output voltage (5 V/div.). Time scale: 2 ms/div.

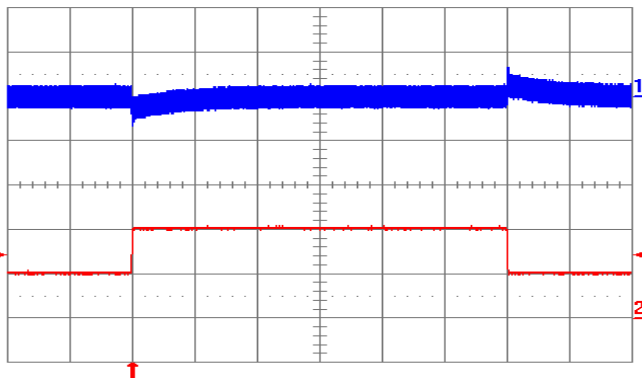

Fig. 12V.11: Output voltage response to load current step-change (1A – 2A – 1A) at $V_{in} = 24\text{V}$. Top trace: output voltage (200 mV/div.). Bottom trace: load current (1 A/div.). Current slew rate: 0.1 A/µs. $C_o = 1\ \mu\text{F}$ ceramic. Time scale: 0.5 ms/div.



Fig. 12V.12: Output voltage response to load current step-change (1A – 2A – 1A) at $V_{in} = 24\text{V}$. Top trace: output voltage (200 mV/div.). Bottom trace: load current (1 A/div.). Current slew rate: 5 A/µs. $C_o = 1\ \mu\text{F}$ ceramic. Time scale: 0.5 ms/div.



Fig. 12V.13: Output voltage ripple (50 mV/div.) at full rated load current into a resistive load with $C_o = 10 \mu\text{F}$ tantalum + $1 \mu\text{F}$ ceramic and $V_{in} = 24 \text{ V}$. Time scale: $1 \mu\text{s}/\text{div}$.



Fig. 12V.14: Test setup for measuring input reflected ripple currents, i_c and i_s .



Fig. 12V.15: Input reflected ripple current, i_c (100 mA/div.), measured at input terminals at full rated load current and $V_{in} = 24 \text{ V}$. Refer to Fig. 12V.14 for test setup. Time scale: $1 \mu\text{s}/\text{div}$.



Fig. 12V.16: Input reflected ripple current, i_s (10 mA/div.), measured through $10 \mu\text{H}$ at the source at full rated load current and $V_{in} = 24 \text{ V}$. Refer to Fig. 12V.14 for test setup. Time scale: $1 \mu\text{s}/\text{div}$.



Fig. 12V.17: Output voltage vs. load current showing current limit point and converter shutdown point. Input voltage has almost no effect on current limit characteristic.



Fig. 12V.18: Load current (top trace, 5 A/div., 20 ms/div.) into a $10 \text{ m}\Omega$ short circuit during restart, at $V_{in} = 24 \text{ V}$. Bottom trace (5 A/div., 1 ms/div.) is an expansion of the on-time portion of the top trace.

6 ELECTRICAL SPECIFICATIONS: SQ24T/S05080 (8.0 VOLTS OUT)

Conditions: T_A = 25 °C, Airflow = 300 LFM (1.5 m/s), Vin = 24 VDC, Vout = 8.0 VDC unless otherwise specified.

PARAMETER	NOTES	MIN	TYP	MAX	UNITS
Input Characteristics					
Maximum Input Current	5.3 ADC, 8.0 VDC Out @ 18 VDC In			2.8	ADC
Input Stand-by Current	Vin = 24 V, converter disabled		2.6		mADC
Input No Load Current (0 load on the output)	Vin = 24 V, converter enabled		68		mADC
Input Reflected-Ripple Current	25 MHz bandwidth		6		mAPK-PK
Input Voltage Ripple Rejection	120 Hz		TBD		dB
Output Characteristics					
Output Voltage Set Point (no load)		7.92	8.00	8.08	VDC
Output Regulation	Over Line		±4	±10	mV
	Over Load		±4	±10	mV
Output Voltage Range	Over line, load and temperature (-40°C to 85°C)	7.88		8.12	VDC
Output Ripple and Noise - 25 MHz bandwidth	Full load + 10 µF tantalum + 1 µF ceramic		70	100	mV _{PK-PK}
External Load Capacitance	Plus full load (resistive)			2200	µF
Output Current Range		0		5.3	ADC
Current Limit Inception	Non-latching		6.25	6.75	ADC
Peak Short-Circuit Current	Non-latching. Short=10mΩ.		10	12	A
RMS Short-Circuit Current	Non-latching			1	Arms
Dynamic Response					
Load Change 25% of Iout Max, di/dt = 0.1 A/µs	Co = 1 µF ceramic		160		mV
	di/dt = 5 A/µs Co = 94 µF tant. + 1 µF ceramic		160		mV
Setting Time to 1%			400		µs
Efficiency					
100% Load			85.5		%
50% Load			87		%



Fig. 8.0V.1: Available load current vs. ambient air temperature and airflow rates for SQ24T05080 converter with D height pins mounted vertically with Vin = 24 V, air flowing from pin 3 to pin 1 and maximum FET temperature ≤ 120°C.

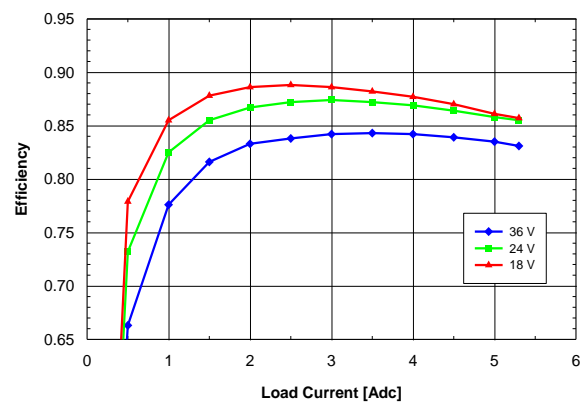

Fig. 8.0V.2: Efficiency vs. load current and input voltage for SQ24T/S05080 converter mounted vertically with air flowing from pin 3 to pin 1 at a rate of 300 LFM (1.5 m/s) and Ta = 25°C.



Asia-Pacific
+86 755 298 85888

Europe, Middle East
+353 61 225 977

North America
+1 408 785 5200

7 ELECTRICAL SPECIFICATIONS: SQ24T/S08060 (6.0 VOLTS OUT)

Conditions: T_A = 25 °C, Airflow = 300 LFM (1.5 m/s), V_{in} = 24 VDC, V_{out} = 6.0 VDC unless otherwise specified.

PARAMETER	NOTES	MIN	TYP	MAX	UNITS
Input Characteristics					
Maximum Input Current	8 ADC, 6.0 VDC Out @ 18 VDC In			3.1	ADC
Input Stand-by Current	V _{in} = 24 V, converter disabled		2.6		mADC
Input No Load Current (0 load on the output)	V _{in} = 24 V, converter enabled		88		mADC
Input Reflected-Ripple Current	25 MHz bandwidth		6		mA _{PK-PK}
Input Voltage Ripple Rejection	120 Hz		TBD		dB
Output Characteristics					
Output Voltage Set Point (no load)		5.940	6.000	6.060	VDC
Output Regulation	Over Line		±2	±5	mV
	Over Load		±2	±5	mV
Output Voltage Range	Over line, load and temperature (-40°C to 85°C)	5.910		6.090	VDC
Output Ripple and Noise - 25 MHz bandwidth	Full load + 10 µF tantalum + 1 µF ceramic		45	60	mV _{PK-PK}
External Load Capacitance	Plus full load (resistive)			10,000	µF
Output Current Range		0		8	ADC
Current Limit Inception	Non-latching		10	11.5	ADC
Peak Short-Circuit Current	Non-latching. Short=10mΩ.		15	25	A
RMS Short-Circuit Current	Non-latching			2.5	Arms
Dynamic Response					
Load Change 25% of I _{out} Max, di/dt = 0.1 A/µs	Co = 1 µF ceramic		100		mV
	di/dt = 5 A/µs Co = 450 µF tant. + 1 µF ceramic		80		mV
Setting Time to 1%			200		µs
Efficiency					
100% Load			89		%
50% Load			89		%



Fig. 6.0V.1: Available load current vs. ambient air temperature and airflow rates for SQ24T08060 converter with B height pins mounted vertically with $V_{in} = 24V$, air flowing from pin 3 to pin 1 and maximum FET temperature $\leq 120^{\circ}C$.



Fig. 6.0V.2: Available load current vs. ambient air temperature and airflow rates for SQ24T08060 converter with B height pins mounted horizontally with $V_{in} = 24V$, air flowing from pin 3 to pin 1 and maximum FET temperature $\leq 120^{\circ}C$.



Fig. 6.0V.3: Available load current vs. ambient temperature and airflow rates for SQ24S08060 converter mounted vertically with $V_{in} = 24V$, air flowing from pin 3 to pin 1 and maximum FET temperature $\leq 120^{\circ}C$.



Fig. 6.0V.4: Available load current vs. ambient temperature and airflow rates for SQ24S08060 converter mounted horizontally with $V_{in} = 24V$, air flowing from pin 3 to pin 1 and maximum FET temperature $\leq 120^{\circ}C$.



Fig. 6.0V.5: Efficiency vs. load current and input voltage for SQ24T/S08060 converter mounted vertically with air flowing from pin 3 to pin 1 at a rate of 300 LFM (1.5 m/s) and $T_a = 25^{\circ}C$.



Fig. 6.0V.6: Efficiency vs. load current and ambient temperature for SQ24T/S08060 converter mounted vertically with $V_{in} = 24V$ and air flowing from pin 3 to pin 1 at a rate of 200 LFM (1.0 m/s).

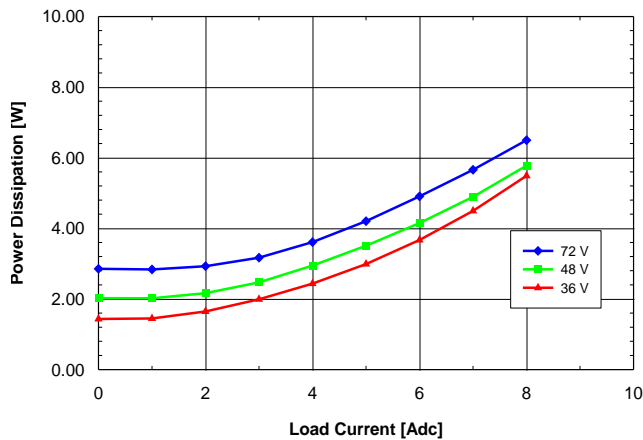

Fig. 6.0V.7: Power dissipation vs. load current and ambient temperature for SQ24T/S08060 converter mounted vertically with air flowing from pin 3 to pin 1 at a rate of 300 LFM (1.5 m/s) and $T_a = 25^\circ\text{C}$.

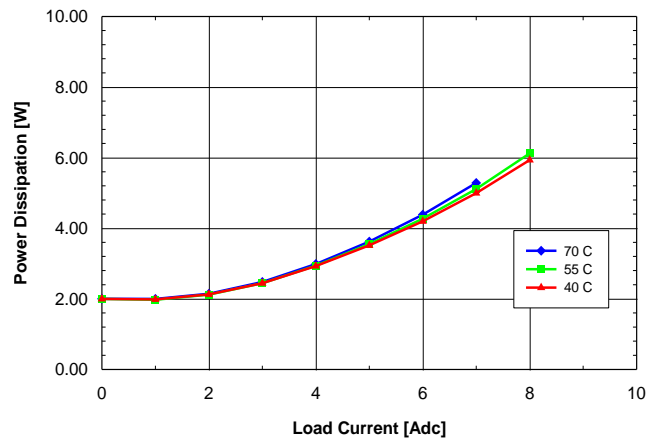

Fig. 6.0V.8: Power dissipation vs. load current and ambient temperature for SQ24T/S08060 converter mounted vertically with $V_{in} = 24\text{V}$ and air flowing from pin 3 to pin 1 at a rate of 200 LFM (1.0 m/s).

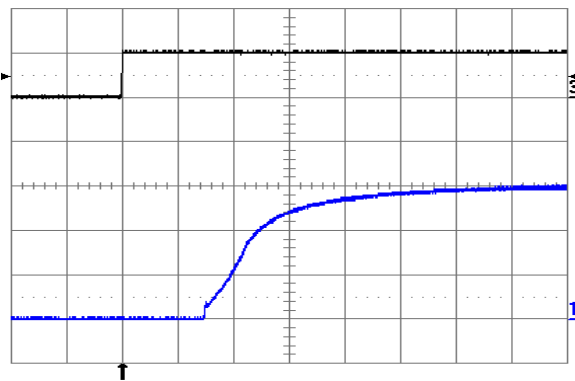

Fig. 6.0V.9: Turn-on transient at full rated load current (resistive) with no output capacitor at $V_{in} = 24\text{V}$, triggered via ON/OFF pin. Top trace: ON/OFF signal (5 V/div.). Bottom trace: output voltage (2 V/div.). Time scale: 1 ms/div.

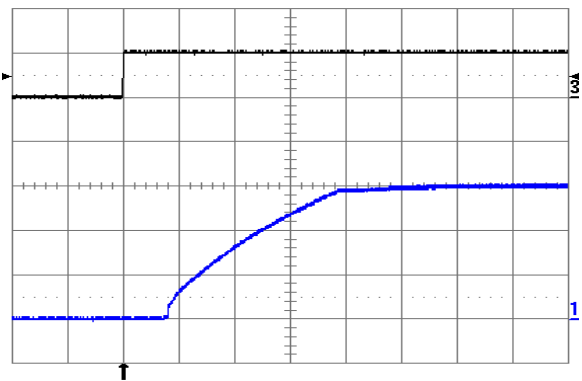

Fig. 6.0V.10: Turn-on transient at full rated load current (resistive) plus 10,000 μF at $V_{in} = 24\text{V}$, triggered via ON/OFF pin. Top trace: ON/OFF signal (5 V/div.). Bottom trace: output voltage (2 V/div.). Time scale: 2 ms/div.

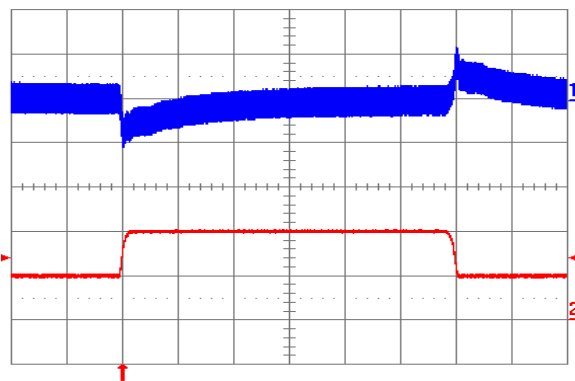

Fig. 6.0V.11: Output voltage response to load current step-change (2A - 4A - 2A) at $V_{in} = 24\text{V}$. Top trace: output voltage (100mV/div.). Bottom trace: load current (2A/div.). Current slew rate: 0.1 A/ μs . $C_o = 1 \mu\text{F}$ ceramic. Time scale: 0.2 ms/div.

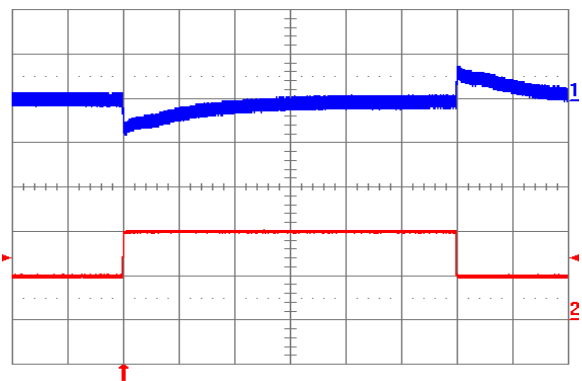

Fig. 6.0V.12: Output voltage response to load current step-change (2A - 4A - 2A) at $V_{in} = 24\text{V}$. Top trace: output voltage (100mV/div.). Bottom trace: load current (2A/div.). Current slew rate: 5 A/ μs . $C_o = 450 \mu\text{F}$ tantalum + 1 μF ceramic. Time scale: 0.2 ms/div.



Fig. 6.0V.13: Output voltage ripple (50 mV/div.) at full rated load current into a resistive load with $C_o = 10 \mu\text{F}$ tantalum + $1\mu\text{F}$ ceramic and $V_{in} = 24 \text{ V}$. Time scale: $1 \mu\text{s}/\text{div}$.

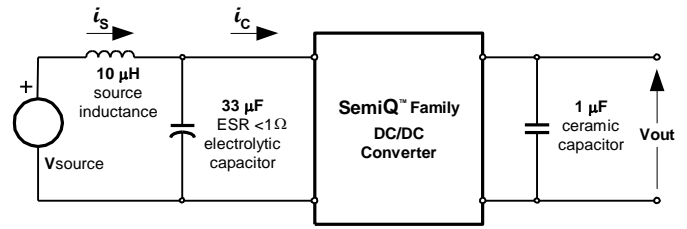

Fig. 6.0V.14: Test setup for measuring input reflected ripple currents, i_c and i_s .



Fig. 6.0V.15: Input reflected ripple current, i_c (100 mA/div.), measured at input terminals at full rated load current and $V_{in} = 24\text{V}$. Refer to Fig. 6.0V.14 for test setup. Time scale: $1 \mu\text{s}/\text{div}$.



Fig. 6.0V.16: Input reflected ripple current, i_s (10 mA/div.), measured through $10 \mu\text{H}$ at the source at full rated load current and $V_{in} = 24\text{V}$. Refer to Fig. 6.0V.14 for test setup. Time scale: $1 \mu\text{s}/\text{div}$.



Fig. 6.0V.17: Output voltage vs. load current showing current limit point and converter shutdown point. Input voltage has almost no effect on current limit characteristic.



Fig. 6.0V.18: Load current (top trace, $20 \text{ A}/\text{div}$., $20 \text{ ms}/\text{div}$.) into a $10 \text{ m}\Omega$ short circuit during restart, at $V_{in} = 24\text{V}$. Bottom trace ($20 \text{ A}/\text{div}$., $2 \text{ ms}/\text{div}$.) is an expansion of the on-time portion of the top trace.

8 ELECTRICAL SPECIFICATIONS: SQ24T/S10050 (5.0 VOLTS OUT)

Conditions: T_A = 25 °C, Airflow=300 LFM (1.5 m/s), V_{in} = 24 VDC, V_{out} = 5.0 VDC unless otherwise specified.

PARAMETER	NOTES	MIN	TYP	MAX	UNITS
Input Characteristics					
Maximum Input Current	10 ADC, 5.0 VDC Out @ 18 VDC In			3.3	ADC
Input Stand-by Current	V _{in} = 24 V, converter disabled		3		mADC
Input No Load Current (0 load on the output)	V _{in} = 24 V, converter enabled		93		mADC
Input Reflected-Ripple Current	25 MHz bandwidth		6		mA _{PK-PK}
Input Voltage Ripple Rejection	120 Hz		TBD		dB
Output Characteristics					
Output Voltage Set Point (no load)		4.950	5.000	5.050	VDC
Output Regulation	Over Line		±2	±5	mV
	Over Load		±2	±5	mV
Output Voltage Range	Over line, load and temperature (-40°C to 85°C)	4.925		5.075	VDC
Output Ripple and Noise - 25 MHz bandwidth	Full load + 10 µF tantalum + 1 µF ceramic		45	80	mV _{PK-PK}
External Load Capacitance	Plus full load (resistive)			10,000	µF
Output Current Range		0		10	ADC
Current Limit Inception	Non-latching		12.5	14	ADC
Peak Short-Circuit Current	Non-latching. Short=10 mΩ.		20	30	A
RMS Short-Circuit Current	Non-latching			3	Arms
Dynamic Response					
Load Change 25% of I _{out} Max, di/dt = 0.1 A/µs	Co = 1 µF ceramic		140		mV
	di/dt = 5 A/µs Co = 450 µF tant. + 1 µF ceramic		90		mV
Setting Time to 1%			200		µs
Efficiency					
100% Load			86		%
50% Load			87		%



Fig. 5.0V.1: Available load current vs. ambient air temperature and airflow rates for SQ24T10050 converter with B height pins mounted vertically with $V_{in} = 24V$, air flowing from pin 3 to pin 1 and maximum FET temperature $\leq 120^{\circ}C$.

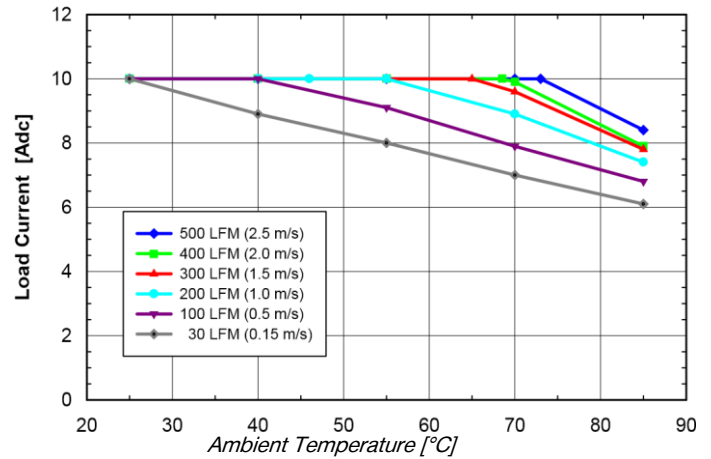

Fig. 5.0V.2: Available load current vs. ambient air temperature and airflow rates for SQ24T10050 converter with B height pins mounted horizontally with $V_{in} = 24V$, air flowing from pin 3 to pin 1 and maximum FET temperature $\leq 120^{\circ}C$.



Fig. 5.0V.3: Available load current vs. ambient temperature and airflow rates for SQ24S10050 converter mounted vertically with $V_{in} = 24V$, air flowing from pin 3 to pin 1 and maximum FET temperature $\leq 120^{\circ}C$.

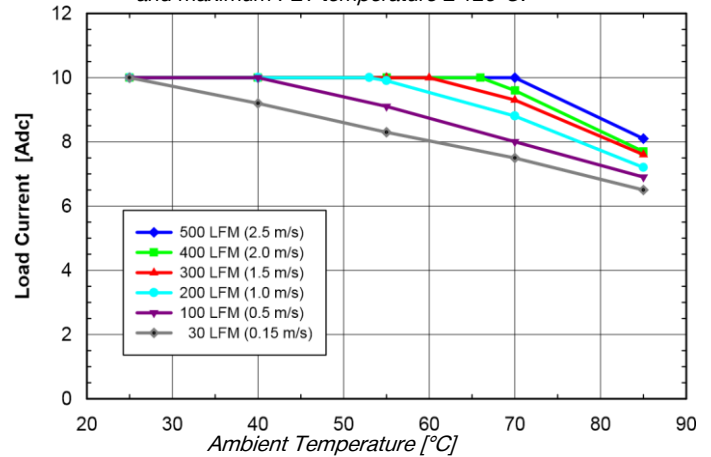

Fig. 5.0V.4: Available load current vs. ambient temperature and airflow rates for SQ24S10050 converter mounted horizontally with $V_{in} = 24V$, air flowing from pin 3 to pin 1 and maximum FET temperature $\leq 120^{\circ}C$.



Fig. 5.0V.5: Efficiency vs. load current and input voltage for SQ24T/S10050 converter mounted vertically with air flowing from pin 3 to pin 1 at a rate of 300 LFM (1.5 m/s) and $T_a = 25^{\circ}C$.

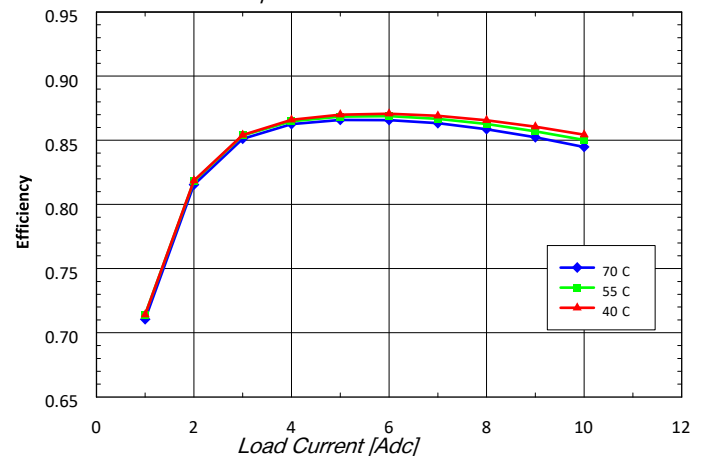

Fig. 5.0V.6: Efficiency vs. load current and ambient temperature for SQ24T/S10050 converter mounted vertically with $V_{in} = 24V$ and air flowing from pin 3 to pin 1 at a rate of 200 LFM (1.0 m/s).



Fig. 5.0V.7: Power dissipation vs. load current and input voltage for SQ24T/S10050 converter mounted vertically with air flowing from pin 3 to pin 1 at a rate of 300 LFM (1.5 m/s) and Ta = 25°C..



Fig. 5.0V.8: Power dissipation vs. load current and ambient temperature for SQ24T/S10050 converter mounted vertically with Vin = 24V and air flowing from pin 3 to pin 1 at a rate of 200 LFM (1.0 m/s).



Fig. 5.0V.9: Turn-on transient at full rated load current (resistive) with no output capacitor at Vin = 24V, triggered via ON/OFF pin. Top trace: ON/OFF signal (5 V/div.). Bottom trace: output voltage (2 V/div.). Time scale: 2 ms/div.



Fig. 5.0V.10: Turn-on transient at full rated load current (resistive) plus 10,000 µF at Vin = 24V, triggered via ON/OFF pin. Top trace: ON/OFF signal (5 V/div.). Bottom trace: output voltage (2 V/div.). Time scale: 2 ms/div.

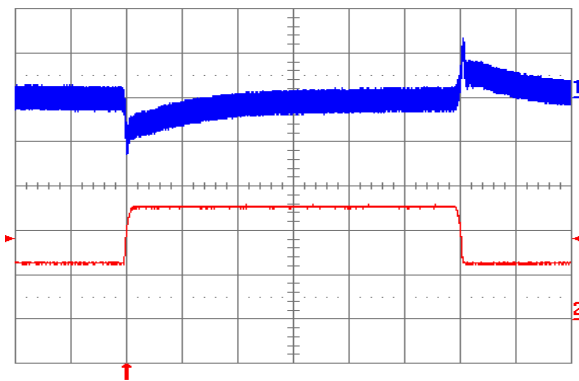

Fig. 5.0V.11: Output voltage response to load current step-change (2.5A – 5A – 2.5A) at Vin = 24V. Top trace: output voltage (100 mV/div.). Bottom trace: load current (2 A/div.). Current slew rate: 0.1 A/µs. Co = 1 µF ceramic. Time scale: 0.2 ms/div.

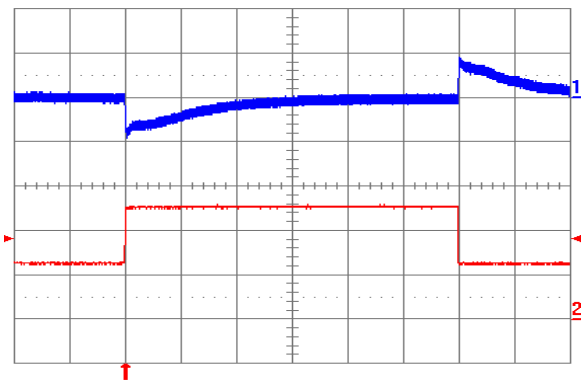

Fig. 5.0V.12: Output voltage response to load current step-change (2.5A – 5A – 2.5A) at Vin = 24V. Top trace: output voltage (100 mV/div.). Bottom trace: load current (2 A/div.). Current slew rate: 5 A/µs. Co = 450 µF tantalum + 1 µF ceramic. Time scale: 0.2 ms/div.

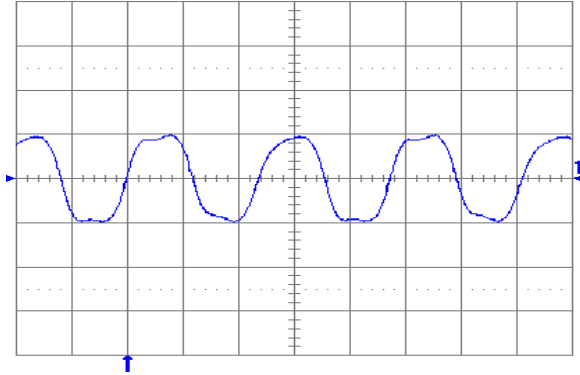

Fig. 5.0V.13: Output voltage ripple (20 mV/div.) at full rated load current into a resistive load with $C_o = 10 \mu\text{F}$ tantalum + $1\mu\text{F}$ ceramic and $V_{in} = 24 \text{ V}$. Time scale: $1 \mu\text{s}/\text{div}$.

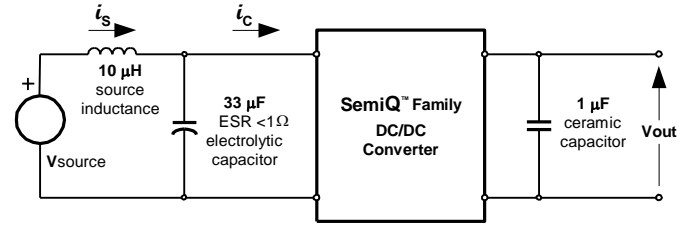

Fig. 5.0V.14: Test setup for measuring input reflected ripple currents, i_c and i_s .

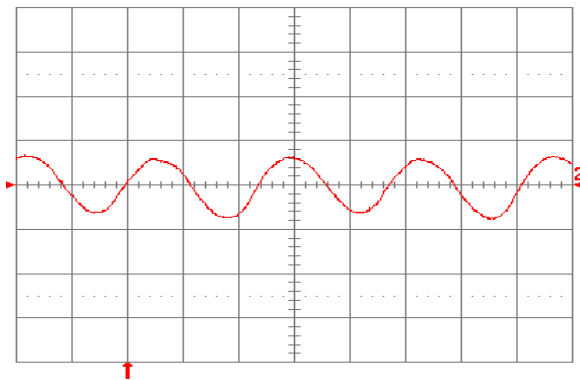

Fig. 5.0V.15: Input reflected ripple current, i_c (100 mA/div.), measured at input terminals at full rated load current and $V_{in} = 24\text{V}$. Refer to Fig. 5.0V.14 for test setup. Time scale: $1 \mu\text{s}/\text{div}$.

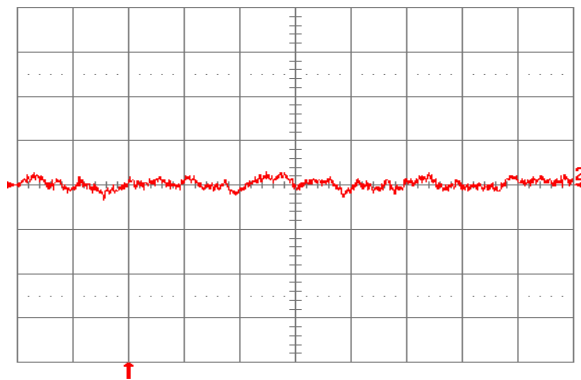

Fig. 5.0V.16: Input reflected ripple current, i_s (10 mA/div.), measured through $10 \mu\text{H}$ at the source at full rated load current and $V_{in} = 24\text{V}$. Refer to Fig. 5.0V.14 for test setup. Time scale: $1 \mu\text{s}/\text{div}$.

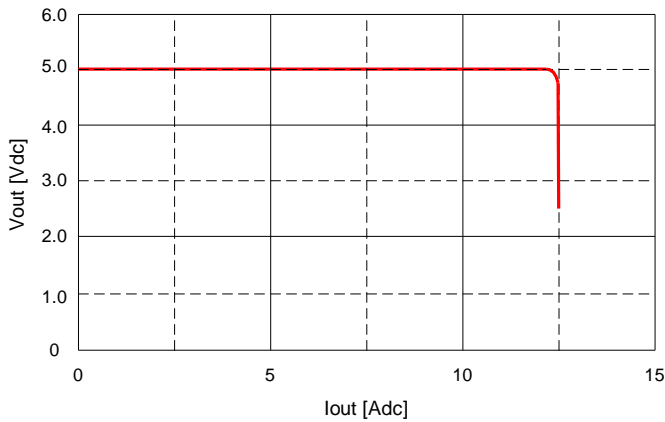

Fig. 5.0V.17: Output voltage vs. load current showing current limit point and converter shutdown point. Input voltage has almost no effect on current limit characteristic.

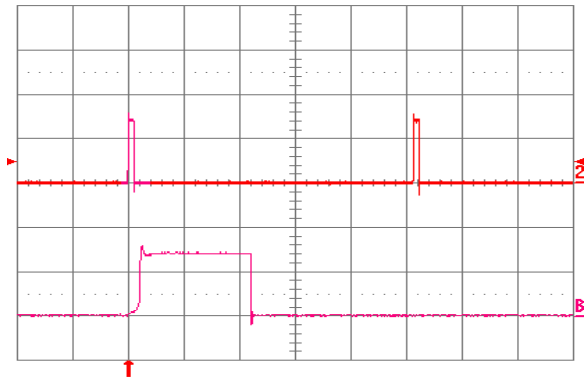

Fig. 5.0V.18: Load current (top trace, 10 A/div., 20 ms/div.) into a $10 \text{ m}\Omega$ short circuit during restart, at $V_{in} = 24\text{V}$. Bottom trace (10 A/div., 1 ms/div.) is an expansion of the on-time portion of the top trace.

9 ELECTRICAL SPECIFICATIONS: SQ24T/S15033 (3.3 VOLTS OUT)

Conditions: T_A = 25 °C, Airflow = 300 LFM (1.5 m/s), V_{in} = 24 VDC, V_{out} = 3.3 VDC unless otherwise specified.

PARAMETER	NOTES	MIN	TYP	MAX	UNITS
Input Characteristics					
Maximum Input Current	15 ADC, 3.3 VDC Out @ 18 VDC In			3.2	ADC
Input Stand-by Current	V _{in} = 24 V, converter disabled		3		mADC
Input No Load Current (0 load on the output)	V _{in} = 24 V, converter enabled		100		mADC
Input Reflected-Ripple Current	25 MHz bandwidth		6		mA _{PK-PK}
Input Voltage Ripple Rejection	120 Hz		TBD		dB
Output Characteristics					
Output Voltage Set Point (no load)		3.267	3.300	3.333	VDC
Output Regulation	Over Line		±2	±5	mV
	Over Load		±2	±5	mV
Output Voltage Range	Over line, load and temperature (-40°C to 85°C)	3.250		3.350	VDC
Output Ripple and Noise - 25 MHz bandwidth	Full load + 10 μF tantalum + 1 μF ceramic		30	50	mV _{PK-PK}
External Load Capacitance	Plus full load (resistive)			15,000	μF
Output Current Range		0		15	ADC
Current Limit Inception	Non-latching		18	20	ADC
Peak Short-Circuit Current	Non-latching. Short=10mΩ.		30	40	A
RMS Short-Circuit Current	Non-latching			5.3	Arms
Dynamic Response					
Load Change 25% of I _{out} Max, di/dt = 0.1 A/μs	Co = 1 μF ceramic		100		mV
	di/dt = 5 A/μs Co = 450 μF tant. + 1 μF ceramic		100		mV
Setting Time to 1%			100		μs
Efficiency					
100% Load			88		%
50% Load			88		%



Fig. 3.3V.1: Available load current vs. ambient air temperature and airflow rates for SQ24T15033 converter with B height pins mounted vertically with $V_{in} = 24V$, air flowing from pin 3 to pin 1 and maximum FET temperature $\leq 120^{\circ}C$.



Fig. 3.3V.2: Available load current vs. ambient air temperature and airflow rates for SQ24T15033 converter with B height pins mounted horizontally with $V_{in} = 24V$, air flowing from pin 3 to pin 1 and maximum FET temperature $\leq 120^{\circ}C$.



Fig. 3.3V.3: Available load current vs. ambient temperature and airflow rates for SQ24S15033 converter mounted vertically with $V_{in} = 24V$, air flowing from pin 3 to pin 1 and maximum FET temperature $\leq 120^{\circ}C$.



Fig. 3.3V.4: Available load current vs. ambient temperature and airflow rates for SQ24S15033 converter mounted horizontally with $V_{in} = 24V$, air flowing from pin 3 to pin 1 and maximum FET temperature $\leq 120^{\circ}C$.



Fig. 3.3V.5: Efficiency vs. load current and input voltage for SQ24T/S15033 converter mounted vertically with air flowing from pin 3 to pin 1 at a rate of 300 LFM (1.5 m/s) and $T_a = 25^{\circ}C$.



Fig. 3.3V.6: Efficiency vs. load current and ambient temperature for SQ24T/S15033 converter mounted vertically with $V_{in} = 24V$ and air flowing from pin 3 to pin 1 at a rate of 200 LFM (1.0 m/s).



Fig. 3.3V.7: Power dissipation vs. load current and input voltage for SQ24T/S15033 converter mounted vertically with air flowing from pin 3 to pin 1 at a rate of 300 LFM (1.5 m/s) and $T_a = 25^\circ\text{C}$.



Fig. 3.3V.8: Power dissipation vs. load current and ambient temperature for SQ24T/S15033 converter mounted vertically with $V_{in} = 24\text{V}$ and air flowing from pin 3 to pin 1 at a rate of 200 LFM (1.0 m/s).

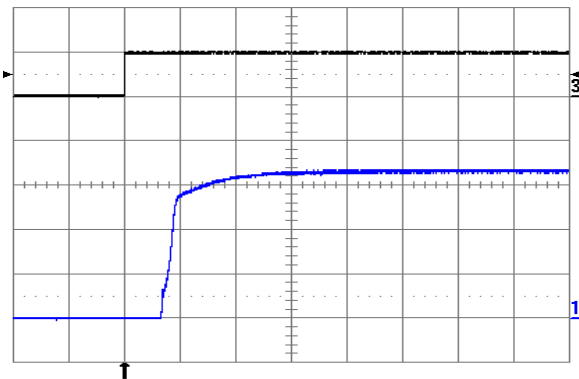

Fig. 3.3V.9: Turn-on transient at full rated load current (resistive) with no output capacitor at $V_{in} = 24\text{V}$, triggered via ON/OFF pin. Top trace: ON/OFF signal (5 V/div.). Bottom trace: output voltage (1 V/div.). Time scale: 2 ms/div.



Fig. 3.3V.10: Turn-on transient at full rated load current (resistive) plus 10,000 μF at $V_{in} = 24\text{V}$, triggered via ON/OFF pin. Top trace: ON/OFF signal (5 V/div.). Bottom trace: output voltage (1 V/div.). Time scale: 2 ms/div.

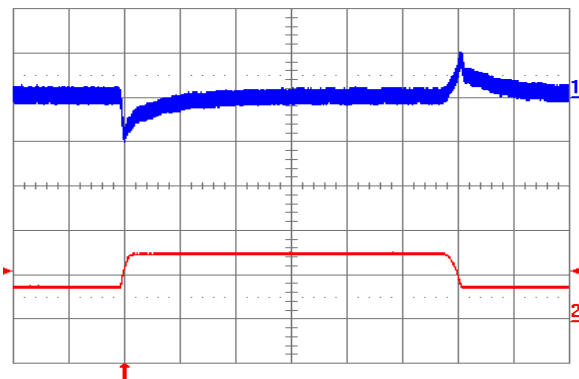

Fig. 3.3V.11: Output voltage response to load current step-change (3.75A – 7.5A – 3.75A) at $V_{in} = 24\text{V}$. Top trace: output voltage (100 mV/div.). Bottom trace: load current (5 A/div.). Current slew rate: 0.1 A/ μs . $C_o = 1 \mu\text{F}$ ceramic. Time scale: 0.2 ms/div.



Fig. 3.3V.12: Output voltage response to load current step-change (3.75A – 7.5A – 3.75A) at $V_{in} = 24\text{V}$. Top trace: output voltage (100 mV/div.). Bottom trace: load current (5 A/div.). Current slew rate: 5 A/ μs . $C_o = 450 \mu\text{F}$ tantalum + 1 μF ceramic. Time scale: 0.2 ms/div.

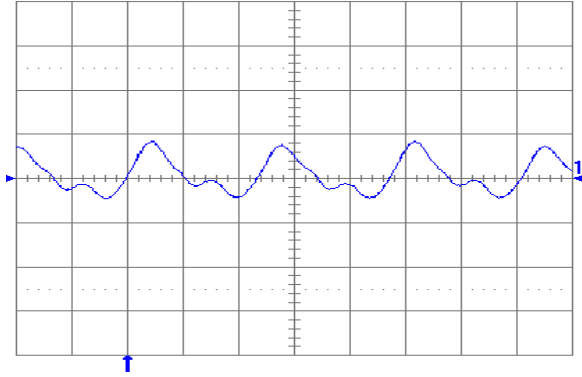

Fig. 3.3V.13: Output voltage ripple (20 mV/div.) at full rated load current into a resistive load with $C_o = 10 \mu\text{F}$ tantalum + $1\mu\text{F}$ ceramic and $V_{in} = 24 \text{ V}$. Time scale: $1 \mu\text{s}/\text{div}$.

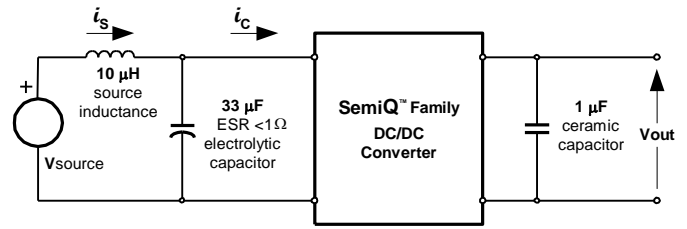

Fig. 3.3V.14: Test setup for measuring input reflected ripple currents, i_c and i_s .

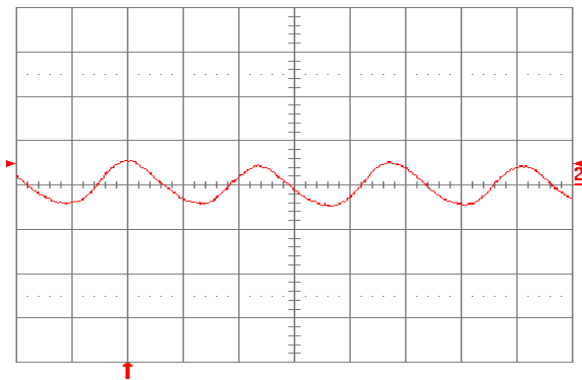

Fig. 3.3V.15: Input reflected ripple current, i_c (100 mA/div.), measured at input terminals at full rated load current and $V_{in} = 24\text{V}$. Refer to Fig. 3.3V.14 for test setup. Time scale: $1 \mu\text{s}/\text{div}$.

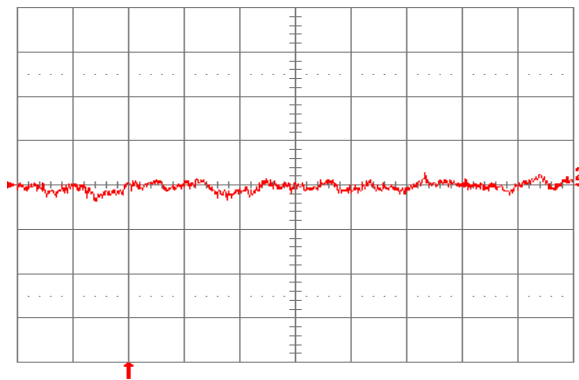

Fig. 3.3V.16: Input reflected ripple current, i_s (10 mA/div.), measured through $10 \mu\text{H}$ at the source at full rated load current and $V_{in} = 24\text{V}$. Refer to Fig. 3.3V.14 for test setup. Time scale: $1 \mu\text{s}/\text{div}$.



Fig. 3.3V.17: Output voltage vs. load current showing current limit point and converter shutdown point. Input voltage has almost no effect on current limit characteristic.



Fig. 3.3V.18: Load current (top trace, 20 A/div., 20 ms/div.) into a $10 \text{ m}\Omega$ short circuit during restart, at $V_{in} = 24\text{V}$. Bottom trace (20 A/div., 1 ms/div.) is an expansion of the on-time portion of the top trace.

10 ELECTRICAL SPECIFICATIONS: SQ24T/S15025 (2.5 VOLTS OUT)Conditions: T_A = 25 °C, Airflow = 300 LFM (1.5 m/s), V_{in} = 24 VDC, V_{out} = 2.5 VDC unless otherwise specified.

PARAMETER	NOTES	MIN	TYP	MAX	UNITS
Input Characteristics					
Maximum Input Current	15 ADC, 2.5 VDC Out @ 18 VDC In			2.5	ADC
Input Stand-by Current	V _{in} = 24 V, converter disabled		3		mADC
Input No Load Current (0 load on the output)	V _{in} = 24 V, converter enabled		67		mADC
Input Reflected-Ripple Current	25 MHz bandwidth		6		mA _{PK-PK}
Input Voltage Ripple Rejection	120 Hz		TBD		dB
Output Characteristics					
Output Voltage Set Point (no load)		2.475	2.500	2.525	VDC
Output Regulation	Over Line		±2	±5	mV
	Over Load		±2	±5	mV
Output Voltage Range	Over line, load and temperature(-40°C to 85°C)	2.462		2.538	VDC
Output Ripple and Noise - 25 MHz bandwidth	Full load + 10 µF tantalum + 1 µF ceramic		30	50	mV _{PK-PK}
External Load Capacitance	Plus full load (resistive)			15,000	µF
Output Current Range		0		15	ADC
Current Limit Inception	Non-latching		18	20	ADC
Peak Short-Circuit Current	Non-latching. Short = 10 mΩ.		30	40	A
RMS Short-Circuit Current	Non-latching			5.3	Arms
Dynamic Response					
Load Change 25% of I _{out} Max, di/dt = 0.1 A/µs	Co = 1 µF ceramic)		110		mV
	di/dt = 5 A/µs Co = 450 µF tant. + 1 µF ceramic		120		mV
Setting Time to 1%			150		µs
Efficiency					
100% Load			86.5		%
50% Load			87		%

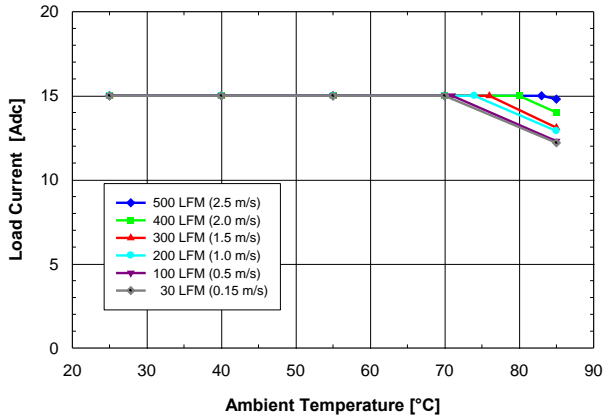

Fig. 2.5V.1: Available load current vs. ambient air temperature and airflow rates for SQ24T15025 converter with B height pins mounted vertically with $V_{in} = 24V$, air flowing from pin 3 to pin 1 and maximum FET temperature $\leq 120^{\circ}C$.

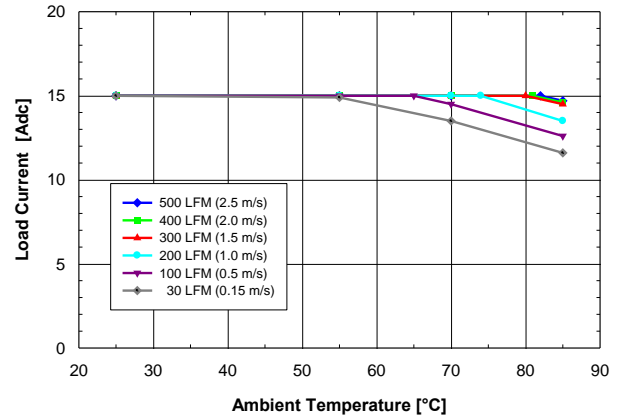

Fig. 2.5V.2: Available load current vs. ambient air temperature and airflow rates for SQ24T15025 converter with B height pins mounted horizontally with $V_{in} = 24V$, air flowing from pin 3 to pin 1 and maximum FET temperature $\leq 120^{\circ}C$.

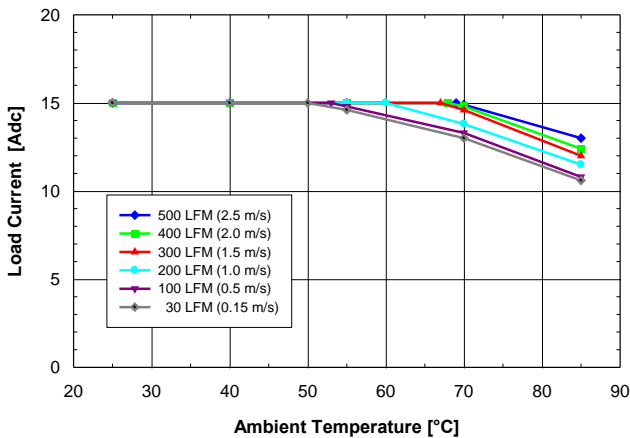

Fig. 2.5V.3: Available load current vs. ambient temperature and airflow rates for SQ24S15025 converter mounted vertically with $V_{in} = 24V$, air flowing from pin 3 to pin 1 and maximum FET temperature $\leq 120^{\circ}C$.

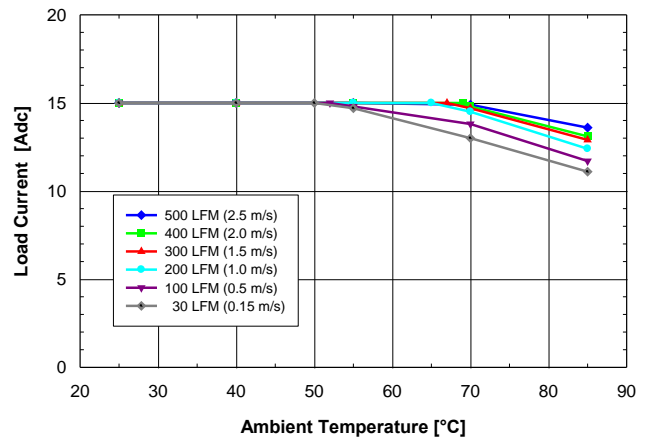

Fig. 2.5V.4: Available load current vs. ambient temperature and airflow rates for SQ24S15025 converter mounted horizontally with $V_{in} = 24V$, air flowing from pin 3 to pin 1 and maximum FET temperature $\leq 120^{\circ}C$.



Fig. 2.5V.5: Efficiency vs. load current and input voltage for SQ24T/S15025 converter mounted vertically with air flowing from pin 3 to pin 1 at a rate of 300 LFM (1.5 m/s) and $T_a = 25^{\circ}C$.

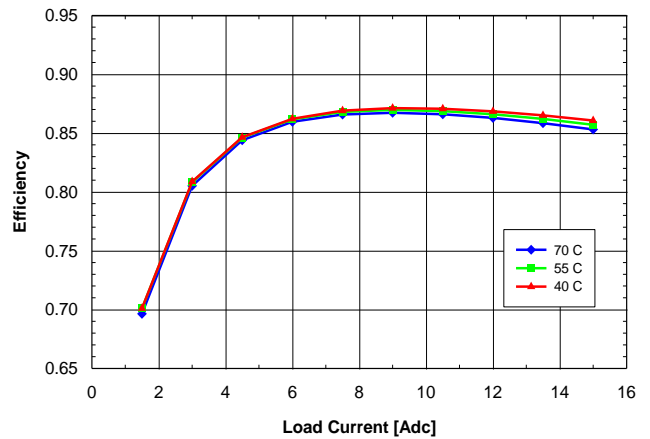

Fig. 2.5V.6: Efficiency vs. load current and ambient temperature for SQ24T/S15025 converter mounted vertically with $V_{in} = 24V$ and air flowing from pin 3 to pin 1 at a rate of 200 LFM (1.0 m/s).





Fig. 2.5V.7: Power dissipation vs. load current and input voltage for SQ24T/S15025 converter mounted vertically with air flowing from pin 3 to pin 1 at a rate of 300 LFM (1.5 m/s) and $T_a = 25^\circ\text{C}$.

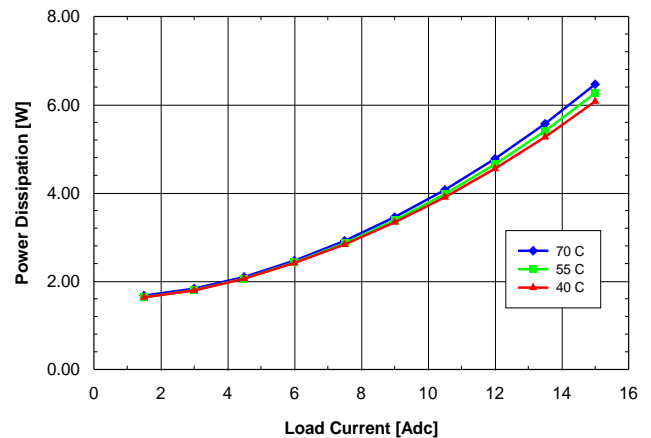

Fig. 2.5V.8: Power dissipation vs. load current and ambient temperature for SQ24T/S15025 converter mounted vertically with $V_{in} = 24\text{V}$ and air flowing from pin 3 to pin 1 at a rate of 200 LFM (1.0 m/s).



Fig. 2.5V.9: Turn-on transient at full rated load current (resistive) with no output capacitor at $V_{in} = 24\text{V}$, triggered via ON/OFF pin. Top trace: ON/OFF signal (5 V/div.). Bottom trace: output voltage (1 V/div.). Time scale: 1 ms/div.



Fig. 2.5V.10: Turn-on transient at full rated load current (resistive) plus 10,000 μF at $V_{in} = 24\text{V}$, triggered via ON/OFF pin. Top trace: ON/OFF signal (5 V/div.). Bottom trace: output voltage (1 V/div.). Time scale: 1 ms/div.



Fig. 2.5V.11: Output voltage response to load current step-change (3.75 A – 7.5 A – 3.75 A) at $V_{in} = 24\text{V}$. Top trace: output voltage (100 mV/div.). Bottom trace: load current (5 A/div.). Current slew rate: 0.1 A/ μs . $C_o = 1 \mu\text{F}$ ceramic. Time scale: 0.2 ms/div.



Fig. 2.5V.12: Output voltage response to load current step-change (3.75 A – 7.5 A – 3.75 A) at $V_{in} = 24\text{V}$. Top trace: output voltage (100 mV/div.). Bottom trace: load current (5 A/div.). Current slew rate: 5 A/ μs . $C_o = 450 \mu\text{F}$ tantalum + 1 μF ceramic. Time scale: 0.2 ms/div.

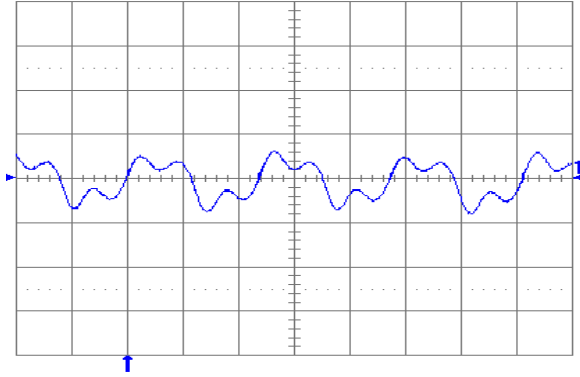

Fig. 2.5V.13: Output voltage ripple (20 mV/div.) at full rated load current into a resistive load with $C_o = 10 \mu\text{F}$ tantalum + $1\mu\text{F}$ ceramic and $V_{in} = 24 \text{ V}$. Time scale: $1 \mu\text{s}/\text{div}$.



Fig. 2.5V.14: Test setup for measuring input reflected ripple currents, i_c and i_s .



Fig. 2.5V.15: Input reflected ripple current, i_c (100 mA/div.), measured at input terminals at full rated load current and $V_{in} = 24 \text{ V}$. Refer to Fig. 2.5V.14 for test setup. Time scale: $1 \mu\text{s}/\text{div}$.



Fig. 2.5V.16: Input reflected ripple current, i_s (10 mA/div.), measured through $10 \mu\text{H}$ at the source at full rated load current and $V_{in} = 24 \text{ V}$. Refer to Fig. 2.5V.14 for test setup. Time scale: $1 \mu\text{s}/\text{div}$.



Fig. 2.5V.17: Output voltage vs. load current showing current limit point and converter shutdown point. Input voltage has almost no effect on current limit characteristic.



Fig. 2.5V.18: Load current (top trace, 20 A/div., 20 ms/div.) into a $10 \text{ m}\Omega$ short circuit during restart, at $V_{in} = 24 \text{ V}$. Bottom trace (20 A/div., 1 ms/div.) is an expansion of the on-time portion of the top trace.

11 ELECTRICAL SPECIFICATIONS: SQ24T/S15020 (2.0 VOLTS OUT)Conditions: T_A = 25 °C, Airflow = 300 LFM (1.5 m/s), V_{in} = 24 VDC, V_{out} = 2.0 VDC unless otherwise specified.

PARAMETER	NOTES	MIN	TYP	MAX	UNITS
Input Characteristics					
Maximum Input Current	15 ADC, 2.0 VDC Out @ 18 VDC In			2	ADC
Input Stand-by Current	V _{in} = 24 V, converter disabled		3		mADC
Input No Load Current (0 load on the output)	V _{in} = 24 V, converter enabled		57		mADC
Input Reflected-Ripple Current	25 MHz bandwidth		6		mA _{PK-PK}
Input Voltage Ripple Rejection	120 Hz		TBD		dB
Output Characteristics					
Output Voltage Set Point (no load)		1.98	2.000	2.02	VDC
Output Regulation	Over Line		±2	±5	mV
	Over Load		±2	±5	mV
Output Voltage Range	Over line, load and temperature (-40°C to 85°C)	1.970		2.030	VDC
Output Ripple and Noise - 25 MHz bandwidth	Full load + 10 µF tantalum + 1 µF ceramic		30	50	mV _{PK-PK}
External Load Capacitance	Plus full load (resistive)			15,000	µF
Output Current Range		0		15	ADC
Current Limit Inception	Non-latching		18	20	ADC
Peak Short-Circuit Current	Non-latching. Short = 10 mΩ.		30	40	A
RMS Short-Circuit Current	Non-latching			5.3	Arms
Dynamic Response					
Load Change 25% of I _{out} Max, di/dt = 0.1 A/µs	Co = 1 µF ceramic		100		mV
	di/dt = 5 A/µs Co = 450 µF tant. + 1 µF ceramic		120		mV
Setting Time to 1%			150		µs
Efficiency					
100% Load			85		%
50% Load			85		%

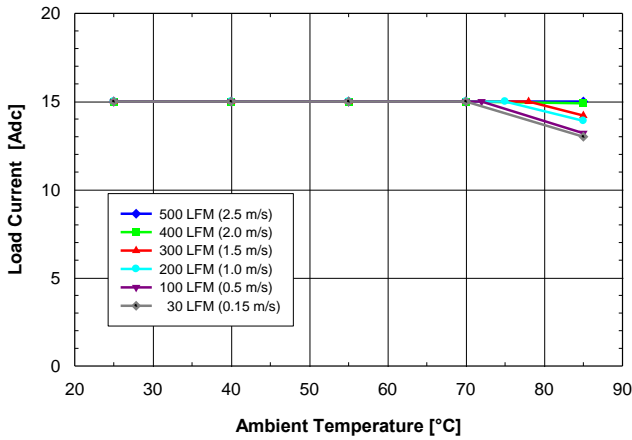

Fig. 2.0V.1: Available load current vs. ambient air temperature and airflow rates for SQ24T15020 converter with B height pins mounted vertically with $V_{in} = 24V$, air flowing from pin 3 to pin 1 and maximum FET temperature $\leq 120^{\circ}C$.



Fig. 2.0V.2: Available load current vs. ambient air temperature and airflow rates for SQ24T15020 converter with B height pins mounted horizontally with $V_{in} = 24V$, air flowing from pin 3 to pin 1 and maximum FET temperature $\leq 120^{\circ}C$.

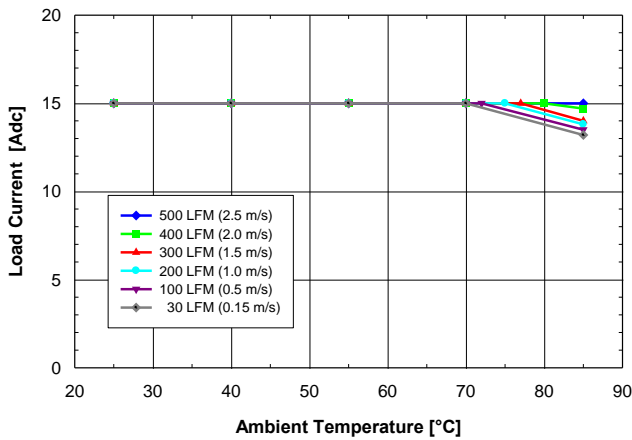

Fig. 2.0V.3: Available load current vs. ambient air temperature and airflow rates for SQ24S15020 converter mounted vertically with $V_{in} = 24V$, air flowing from pin 3 to pin 1 and maximum FET temperature $\leq 120^{\circ}C$.



Fig. 2.0V.4: Available load current vs. ambient air temperature and airflow rates for SQ24S15020 converter mounted horizontally with $V_{in} = 24V$, air flowing from pin 3 to pin 1 and maximum FET temperature $\leq 120^{\circ}C$.

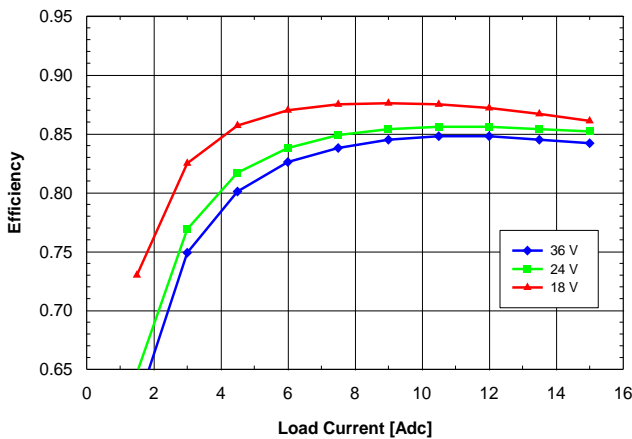

Fig. 2.0V.5: Efficiency vs. load current and input voltage for SQ24T/S15020 converter mounted vertically with air flowing from pin 3 to pin 1 at a rate of 300 LFM (1.5 m/s) and $T_a = 25^{\circ}C$.



Fig. 2.0V.6: Efficiency vs. load current and ambient temperature for SQ24T/S15020 converter mounted vertically with $V_{in} = 24V$ and air flowing from pin 3 to pin 1 at a rate of 200 LFM (1.0 m/s).



Fig. 2.0V.7: Power dissipation vs. load current and input voltage for SQ24T/S15020 converter mounted vertically with air flowing from pin 3 to pin 1 at a rate of 300 LFM (1.5 m/s) and $T_a = 25^\circ\text{C}$.



Fig. 2.0V.8: Power dissipation vs. load current and ambient temperature for SQ24T/S15020 converter mounted vertically with $V_{in} = 24\text{V}$ and air flowing from pin 3 to pin 1 at a rate of 200 LFM (1.0 m/s).



Fig. 2.0V.9: Turn-on transient at full rated load current (resistive) with no output capacitor at $V_{in} = 24\text{V}$, triggered via ON/OFF pin. Top trace: ON/OFF signal (5 V/div.). Bottom trace: output voltage (1 V/div.). Time scale: 1 ms/div.



Fig. 2.0V.10: Turn-on transient at full rated load current (resistive) plus 10,000µF at $V_{in} = 24\text{V}$, triggered via ON/OFF pin. Top trace: ON/OFF signal (5 V/div.). Bottom trace: output voltage (1 V/div.). Time scale: 1 ms/div.



Fig. 2.0V.11: Output voltage response to load current step-change (3.75A – 7.5A – 3.75A) at $V_{in} = 24\text{V}$. Top trace: output voltage (100 mV/div.). Bottom trace: load current (5 A/div.). Current slew rate: 0.1 A/µs. $C_o = 1\ \mu\text{F}$ ceramic. Time scale: 0.2 ms/div.



Fig. 2.0V.12: Output voltage response to load current step-change (3.75A – 7.5A – 3.75A) at $V_{in} = 24\text{V}$. Top trace: output voltage (100 mV/div.). Bottom trace: load current (5 A/div.). Current slew rate: 5 A/µs. $C_o = 450\ \mu\text{F}$ tantalum + 1 µF ceramic. Time scale: 0.2 ms/div.



Fig. 2.0V.13: Output voltage ripple (20 mV/div.) at full rated load current into a resistive load with $C_o = 10 \mu\text{F}$ tantalum + $1 \mu\text{F}$ ceramic and $V_{in} = 24 \text{ V}$. Time scale: $1 \mu\text{s}/\text{div}$.



Fig. 2.0V.14: Test setup for measuring input reflected ripple currents, i_c and i_s .



Fig. 2.0V.15: Input reflected ripple current, i_c (100 mA/div.), measured at input terminals at full rated load current and $V_{in} = 24 \text{ V}$. Refer to Fig. 2.0V.14 for test setup. Time scale: $1 \mu\text{s}/\text{div}$.



Fig. 2.0V.16: Input reflected ripple current, i_s (10 mA/div.), measured through $10 \mu\text{H}$ at the source at full rated load current and $V_{in} = 24 \text{ V}$. Refer to Fig. 2.0V.14 for test setup. Time scale: $1 \mu\text{s}/\text{div}$.



Fig. 2.0V.17: Output voltage vs. load current showing current limit point and converter shutdown point. Input voltage has almost no effect on current limit characteristic.

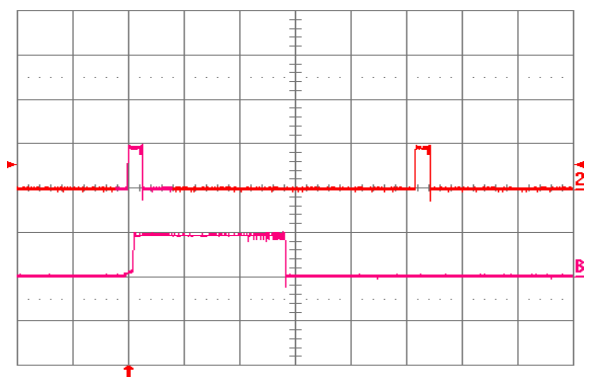

Fig. 2.0V.18: Load current (top trace, $20 \text{ A}/\text{div}$., $20 \text{ ms}/\text{div}$.) into a $10 \text{ m}\Omega$ short circuit during restart, at $V_{in} = 24 \text{ V}$. Bottom trace ($20 \text{ A}/\text{div}$., $2 \text{ ms}/\text{div}$.) is an expansion of the on-time portion of the top trace.

12 ELECTRICAL SPECIFICATIONS: SQ24T/S15018 (1.8 VOLTS OUT)Conditions: T_A = 25 °C, Airflow = 300 LFM (1.5 m/s), V_{in} = 24 VDC, V_{out} = 1.8 VDC unless otherwise specified.

PARAMETER	NOTES	MIN	TYP	MAX	UNITS
Input Characteristics					
Maximum Input Current	15 ADC, 1.8 VDC Out @ 18 VDC In			1.8	ADC
Input Stand-by Current	V _{in} = 24 V, converter disabled		3		mADC
Input No Load Current (0 load on the output)	V _{in} = 24 V, converter enabled		53		mADC
Input Reflected-Ripple Current	25 MHz bandwidth		6		mA _{PK-PK}
Input Voltage Ripple Rejection	120 Hz		TBD		dB
Output Characteristics					
Output Voltage Set Point (no load)		1.782	1.800	1.818	VDC
Output Regulation	Over Line		±2	±4	mV
	Over Load		±2	±5	mV
Output Voltage Range	Over line, load and temperature (-40°C to 85°C)	1.773		1.827	VDC
Output Ripple and Noise - 25 MHz bandwidth	Full load + 10 µF tantalum + 1 µF ceramic		30	50	mV _{PK-PK}
External Load Capacitance	Plus full load (resistive)			15,000	µF
Output Current Range		0		15	ADC
Current Limit Inception	Non-latching		18	20	ADC
Peak Short-Circuit Current	Non-latching. Short = 10 mΩ.		30	40	A
RMS Short-Circuit Current	Non-latching			5.3	Arms
Dynamic Response					
Load Change 25% of I _{out} Max, di/dt = 0.1 A/µs	Co = 1 µF ceramic		100		mV
	di/dt = 5 A/µs Co = 450 µF tant. + 1 µF ceramic		120		mV
Setting Time to 1%			150		µs
Efficiency					
100% Load			84.5		%
50% Load			84		%



Fig. 1.8V.1: Available load current vs. ambient air temperature and airflow rates for SQ24T15018 converter with B height pins mounted vertically with $V_{in} = 24V$, air flowing from pin 3 to pin 1 and maximum FET temperature $\leq 120^{\circ}C$.



Fig. 1.8V.2: Available load current vs. ambient air temperature and airflow rates for SQ24T15018 converter with B height pins mounted horizontally with $V_{in} = 24V$, air flowing from pin 3 to pin 1 and maximum FET temperature $\leq 120^{\circ}C$.



Fig. 1.8V.3: Available load current vs. ambient temperature and airflow rates for SQ24S15018 converter mounted vertically with $V_{in} = 24V$, air flowing from pin 3 to pin 1 and maximum FET temperature $\leq 120^{\circ}C$.



Fig. 1.8V.4: Available load current vs. ambient temperature and airflow rates for SQ24S15018 converter mounted horizontally with $V_{in} = 24V$, air flowing from pin 3 to pin 1 and maximum FET temperature $\leq 120^{\circ}C$.



Fig. 1.8V.5: Efficiency vs. load current and input voltage for SQ24T/S15018 converter mounted vertically with air flowing from pin 3 to pin 1 at a rate of 300 LFM (1.5 m/s) and $T_a = 25^{\circ}C$.



Fig. 1.8V.6: Efficiency vs. load current and ambient temperature for SQ24T/S15018 converter mounted vertically with $V_{in} = 24V$ and air flowing from pin 3 to pin 1 at a rate of 200 LFM (1.0 m/s).



Fig. 1.8V.7: Power dissipation vs. load current and input voltage for SQ24T/S15018 converter mounted vertically with air flowing from pin 3 to pin 1 at a rate of 300 LFM (1.5 m/s) and $T_a = 25^\circ\text{C}$.



Fig. 1.8V.8: Power dissipation vs. load current and ambient temperature for SQ24T/S15018 converter mounted vertically with $V_{in} = 24\text{V}$ and air flowing from pin 3 to pin 1 at a rate of 200 LFM (1.0 m/s).



Fig. 1.8V.9: Turn-on transient at full rated load current (resistive) with no output capacitor at $V_{in} = 24\text{V}$, triggered via ON/OFF pin. Top trace: ON/OFF signal (5 V/div.). Bottom trace: output voltage (1 V/div.). Time scale: 1 ms/div.



Fig. 1.8V.10: Turn-on transient at full rated load current (resistive) plus 10,000µF at $V_{in} = 24\text{V}$, triggered via ON/OFF pin. Top trace: ON/OFF signal (5 V/div.). Bottom trace: output voltage (1 V/div.). Time scale: 1 ms/div.



Fig. 1.8V.11: Output voltage response to load current step-change (3.75A – 7.5A – 3.75A) at $V_{in} = 24\text{V}$. Top trace: output voltage (100 mV/div.). Bottom trace: load current (5 A/div.). Current slew rate: 0.1 A/µs. $C_o = 1\ \mu\text{F}$ ceramic. Time scale: 0.2 ms/div.



Fig. 1.8V.12: Output voltage response to load current step-change (3.75A – 7.5A – 3.75A) at $V_{in} = 24\text{V}$. Top trace: output voltage (100 mV/div.). Bottom trace: load current (5 A/div.). Current slew rate: 5 A/µs. $C_o = 450\ \mu\text{F}$ tantalum + 1 µF ceramic. Time scale: 0.2 ms/div.

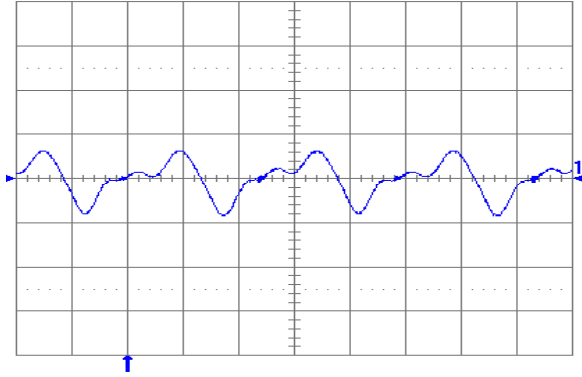

Fig. 1.8V.13: Output voltage ripple (20 mV/div.) at full rated load current into a resistive load with $C_o = 10 \mu\text{F}$ tantalum + $1\mu\text{F}$ ceramic and $V_{in} = 24 \text{ V}$. Time scale: $1 \mu\text{s}/\text{div}$.



Fig. 1.8V.14: Test setup for measuring input reflected ripple currents, i_c and i_s .

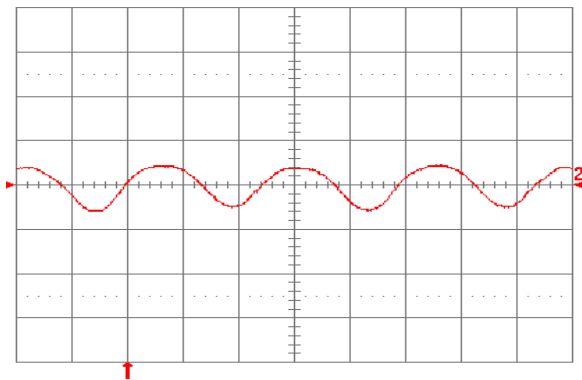

Fig. 1.8V.15: Input reflected ripple current, i_c (100 mA/div.), measured at input terminals at full rated load current and $V_{in} = 24 \text{ V}$. Refer to Fig. 1.8V.14 for test setup. Time scale: $1 \mu\text{s}/\text{div}$.

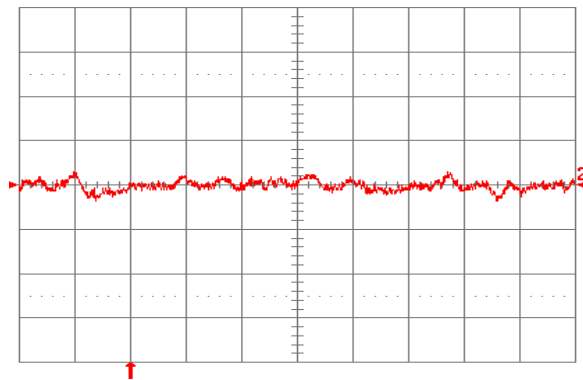

Fig. 1.8V.16: Input reflected ripple current, i_s (10 mA/div.), measured through $10 \mu\text{H}$ at the source at full rated load current and $V_{in} = 24 \text{ V}$. Refer to Fig. 1.8V.14 for test setup. Time scale: $1 \mu\text{s}/\text{div}$.



Fig. 1.8V.17: Output voltage vs. load current showing current limit point and converter shutdown point. Input voltage has almost no effect on current limit characteristic.

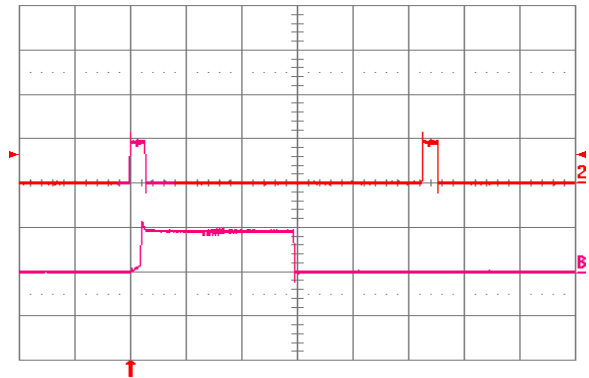

Fig. 1.8V.18: Load current (top trace, 20 A/div., 20 ms/div.) into a $10 \text{ m}\Omega$ short circuit during restart, at $V_{in} = 24 \text{ V}$. Bottom trace (20 A/div., 2 ms/div.) is an expansion of the on-time portion of the top trace.

13 ELECTRICAL SPECIFICATIONS: SQ24T/S15015 (1.5 VOLTS OUT)Conditions: T_A = 25 °C, Airflow = 300 LFM (1.5 m/s), V_{in} = 24 VDC, V_{out} = 1.5 VDC unless otherwise specified.

PARAMETER	NOTES	MIN	TYP	MAX	UNITS
Input Characteristics					
Maximum Input Current	15 ADC, 1.5 VDC Out @ 18 VDC In			1.6	ADC
Input Stand-by Current	V _{in} = 24 V, converter disabled		2.6		mADC
Input No Load Current (0 load on the output)	V _{in} = 24 V, converter enabled		48		mADC
Input Reflected-Ripple Current	25 MHz bandwidth		6		mA _{PK-PK}
Input Voltage Ripple Rejection	120 Hz		TBD		dB
Output Characteristics					
Output Voltage Set Point (no load)		1.485	1.500	1.515	VDC
Output Regulation	Over Line		±2	±4	mV
	Over Load		±2	±4	mV
Output Voltage Range	Over line, load and temperature (-40°C to 85°C)	1.477		1.523	VDC
Output Ripple and Noise - 25 MHz bandwidth	Full load + 10 µF tantalum + 1 µF ceramic		30	50	mV _{PK-PK}
External Load Capacitance	Plus full load (resistive)			15,000	µF
Output Current Range		0		15	ADC
Current Limit Inception	Non-latching		18	20	ADC
Peak Short-Circuit Current	Non-latching. Short = 10 mΩ.		30	40	A
RMS Short-Circuit Current	Non-latching			5.3	Arms
Dynamic Response					
Load Change 25% of I _{out} Max, di/dt = 0.1 A/µs	Co = 1 µF ceramic		80		mV
	di/dt = 5 A/µs Co = 450 µF tant. + 1 µF ceramic		120		mV
Setting Time to 1%			170		µs
Efficiency					
100% Load			83		%
50% Load			83		%



Fig. 1.5V.1: Available load current vs. ambient air temperature and airflow rates for SQ24T15015 converter with B height pins mounted vertically with $V_{in} = 24V$, air flowing from pin 3 to pin 1 and maximum FET temperature $\leq 120^{\circ}C$.



Fig. 1.5V.2: Available load current vs. ambient air temperature and airflow rates for SQ24T15015 converter with B height pins mounted horizontally with $V_{in} = 24V$, air flowing from pin 3 to pin 1 and maximum FET temperature $\leq 120^{\circ}C$.



Fig. 1.5V.3: Available load current vs. ambient temperature and airflow rates for SQ24S15015 converter mounted vertically with $V_{in} = 24V$, air flowing from pin 3 to pin 1 and maximum FET temperature $\leq 120^{\circ}C$.



Fig. 1.5V.4: Available load current vs. ambient temperature and airflow rates for SQ24S15015 converter mounted horizontally with $V_{in} = 24V$, air flowing from pin 3 to pin 1 and maximum FET temperature $\leq 120^{\circ}C$.

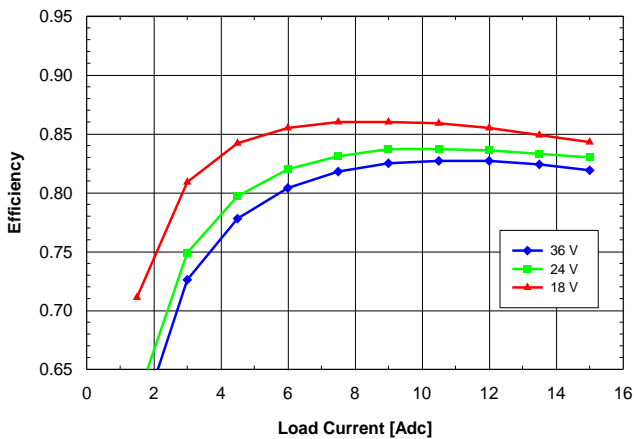

Fig. 1.5V.5: Efficiency vs. load current and input voltage for SQ24T/S15015 converter mounted vertically with air flowing from pin 3 to pin 1 at a rate of 300 LFM (1.5 m/s) and $T_a = 25^{\circ}C$.

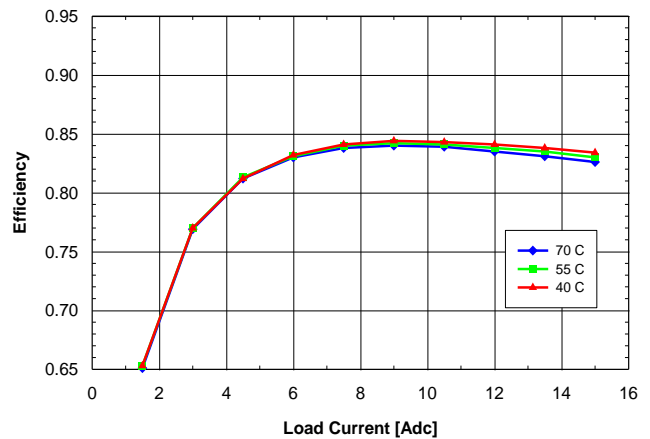

Fig. 1.5V.6: Efficiency vs. load current and ambient temperature for SQ24T/S15015 converter mounted vertically with $V_{in} = 24V$ and air flowing from pin 3 to pin 1 at a rate of 200 LFM (1.0 m/s).

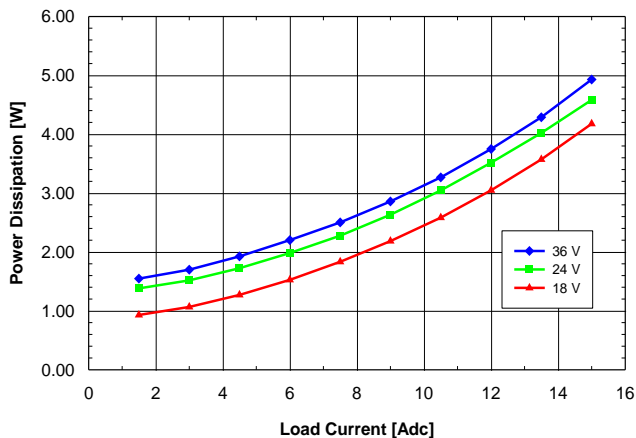

Fig. 1.5V.7: Power dissipation vs. load current and input voltage for SQ24T/S15015 converter mounted vertically with air flowing from pin 3 to pin 1 at a rate of 300 LFM (1.5 m/s) and T_a = 25°C.

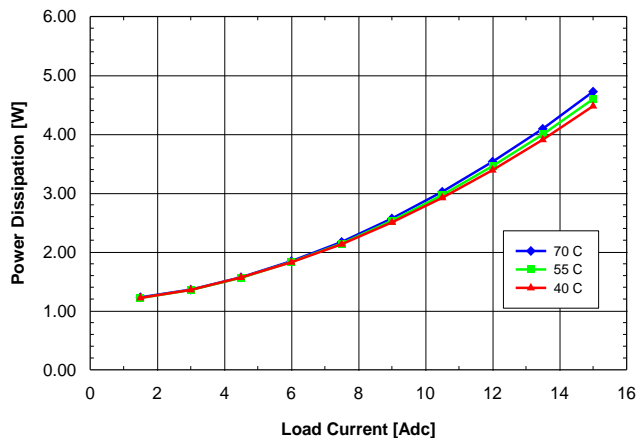

Fig. 1.5V.8: Power dissipation vs. load current and ambient temperature for SQ24T/S15015 converter mounted vertically with V_{in} = 24V and air flowing from pin 3 to pin 1 at a rate of 200 LFM (1.0 m/s).

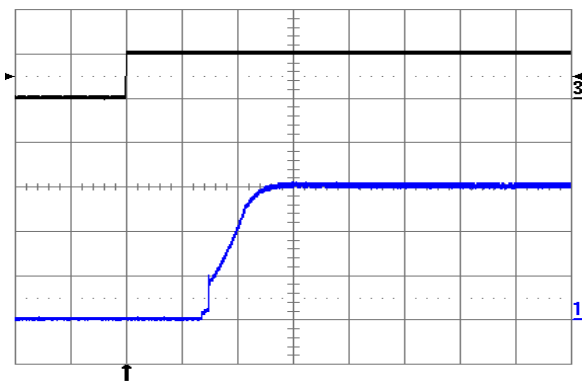

Fig. 1.5V.9: Turn-on transient at full rated load current (resistive) with no output capacitor at V_{in} = 24V, triggered via ON/OFF pin. Top trace: ON/OFF signal (5 V/div.). Bottom trace: output voltage (0.5 V/div.). Time scale: 1 ms/div.

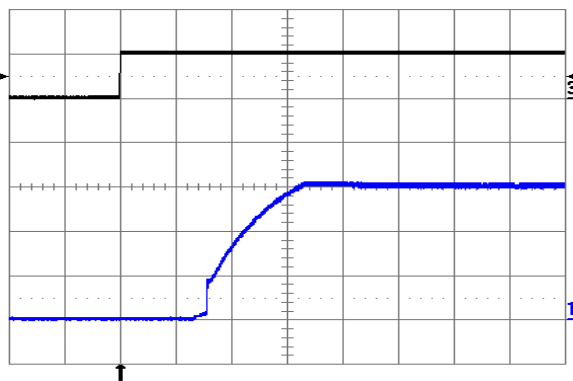

Fig. 1.5V.10: Turn-on transient at full rated load current (resistive) plus 10,000 µF at V_{in} = 24V, triggered via ON/OFF pin. Top trace: ON/OFF signal (5 V/div.). Bottom trace: output voltage (0.5 V/div.). Time scale: 1 ms/div.

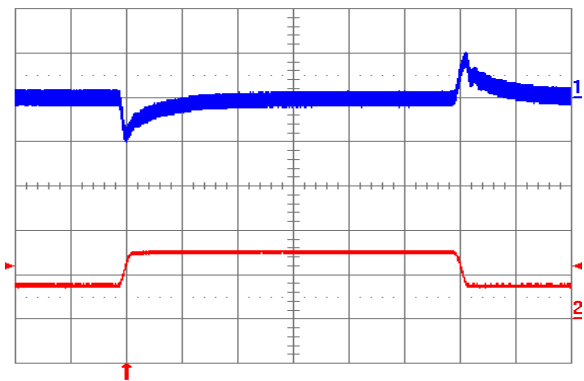

Fig. 1.5V.11: Output voltage response to load current step-change (3.75 A – 7.5 A – 3.75 A) at V_{in} = 24V. Top trace: output voltage (100 mV/div.). Bottom trace: load current (5 A/div.). Current slew rate: 0.1 A/µs. C_o = 1 µF ceramic. Time scale: 0.2 ms/div.

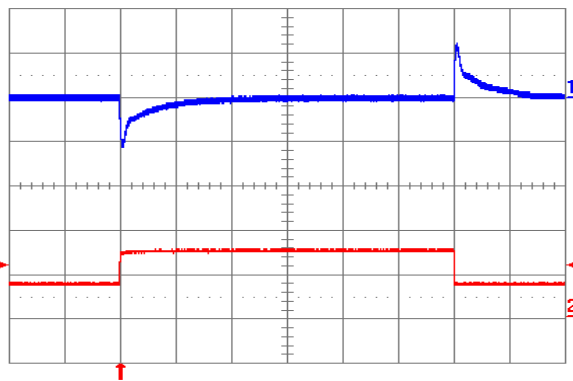

Fig. 1.5V.12: Output voltage response to load current step-change (3.75 A – 7.5 A – 3.75 A) at V_{in} = 24V. Top trace: output voltage (100 mV/div.). Bottom trace: load current (5 A/div.). Current slew rate: 5 A/µs. C_o = 450 µF tantalum + 1 µF ceramic. Time scale: 0.2 ms/div.



Fig. 1.5V.13: Output voltage ripple (20 mV/div.) at full rated load current into a resistive load with $C_o = 10 \mu\text{F}$ tantalum + $1\mu\text{F}$ ceramic and $V_{in} = 24 \text{ V}$. Time scale: $1 \mu\text{s}/\text{div}$.



Fig. 1.5V.14: Test setup for measuring input reflected ripple currents, i_c and i_s .



Fig. 1.5V.15: Input reflected ripple current, i_c (100 mA/div.), measured at input terminals at full rated load current and $V_{in} = 24\text{V}$. Refer to Fig. 1.5V.14 for test setup. Time scale: $1 \mu\text{s}/\text{div}$.



Fig. 1.5V.16: Input reflected ripple current, i_s (10 mA/div.), measured through $10 \mu\text{H}$ at the source at full rated load current and $V_{in} = 24\text{V}$. Refer to Fig. 1.5V.14 for test setup. Time scale: $1 \mu\text{s}/\text{div}$.

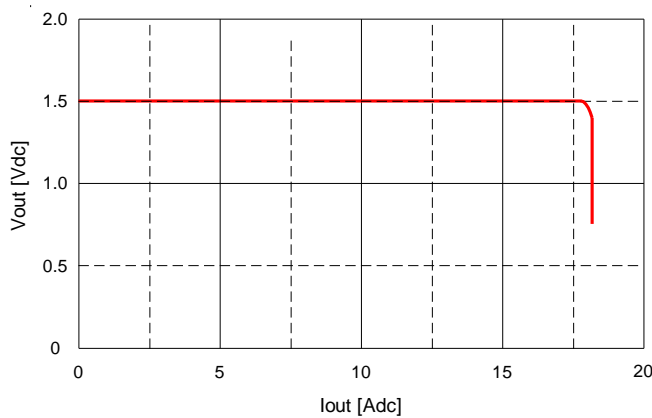

Fig. 1.5V.17: Output voltage vs. load current showing current limit point and converter shutdown point. Input voltage has almost no effect on current limit characteristic.

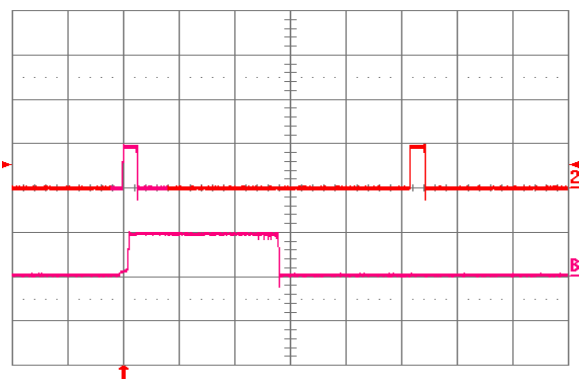

Fig. 1.5V.18: Load current (top trace, 20 A/div., 20 ms/div.) into a $10 \text{ m}\Omega$ short circuit during restart, at $V_{in} = 24\text{V}$. Bottom trace (20 A/div., 2 ms/div.) is an expansion of the on-time portion of the top trace.

14 ELECTRICAL SPECIFICATIONS: SQ24T/S15012 (1.2 VOLTS OUT)

Conditions: T_A = 25°C, Airflow = 300 LFM (1.5 m/s), V_{in} = 24 VDC, V_{out} = 1.2 VDC unless otherwise specified.

PARAMETER	NOTES	MIN	TYP	MAX	UNITS
Input Characteristics					
Maximum Input Current	15 ADC, 1.2 VDC Out @ 18 VDC In			1.25	ADC
Input Stand-by Current	V _{in} = 24 V, converter disabled		2.6		mADC
Input No Load Current (0 load on the output)	V _{in} = 24 V, converter enabled		43		mADC
Input Reflected-Ripple Current	25 MHz bandwidth		6		mA _{PK-PK}
Input Voltage Ripple Rejection	120 Hz		TBD		dB
Output Characteristics					
Output Voltage Set Point (no load)		1.188	1.200	1.212	VDC
Output Regulation	Over Line		±1	±3	mV
	Over Load		±1	±3	mV
Output Voltage Range	Over line, load and temperature (-40°C to 85°C)	1.182		1.218	VDC
Output Ripple and Noise - 25 MHz bandwidth	Full load + 10 µF tantalum + 1 µF ceramic		30	50	mV _{PK-PK}
External Load Capacitance	Plus full load (resistive)			15,000	µF
Output Current Range		0		15	ADC
Current Limit Inception	Non-latching		18	20	ADC
Peak Short-Circuit Current	Non-latching. Short=10 mΩ.		30	40	A
RMS Short-Circuit Current	Non-latching			5.3	Arms
Dynamic Response					
Load Change 25% of I _{out} Max, di/dt = 0.1 A/µs	Co = 1 µF ceramic		90		mV
	di/dt = 5 A/µs Co = 450 µF tant. + 1 µF ceramic		120		mV
Setting Time to 1%			200		µs
Efficiency					
100% Load			81		%
50% Load			81		%



Fig. 1.2V.1: Available load current vs. ambient air temperature and airflow rates for SQ24T15012 converter with B height pins mounted vertically with $V_{in} = 24V$, air flowing from pin 3 to pin 1 and maximum FET temperature $\leq 120^{\circ}C$.



Fig. 1.2V.2: Available load current vs. ambient air temperature and airflow rates for SQ24T15012 converter with B height pins mounted horizontally with $V_{in} = 24V$, air flowing from pin 3 to pin 1 and maximum FET temperature $\leq 120^{\circ}C$.



Fig. 1.2V.3: Available load current vs. ambient temperature and airflow rates for SQ24S15012 converter mounted vertically with $V_{in} = 24V$, air flowing from pin 3 to pin 1 and maximum FET temperature $\leq 120^{\circ}C$.



Fig. 1.2V.4: Available load current vs. ambient temperature and airflow rates for SQ24S15012 converter mounted horizontally with $V_{in} = 24V$, air flowing from pin 3 to pin 1 and maximum FET temperature $\leq 120^{\circ}C$.



Fig. 1.2V.5: Efficiency vs. load current and input voltage for SQ24T/S15012 converter mounted vertically with air flowing from pin 3 to pin 1 at a rate of 300 LFM (1.5 m/s) and $T_a = 25^{\circ}C$.



Fig. 1.2V.6: Efficiency vs. load current and ambient temperature for SQ24T/S15012 converter mounted vertically with $V_{in} = 24V$ and air flowing from pin 3 to pin 1 at a rate of 200 LFM (1.0 m/s).



Fig. 1.2V.7: Power dissipation vs. load current and input voltage for SQ24T/S15012 converter mounted vertically with air flowing from pin 3 to pin 1 at a rate of 300 LFM (1.5 m/s) and T_a = 25°C.

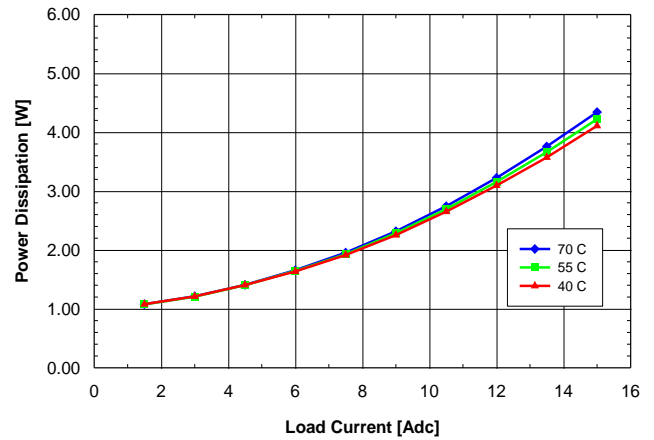

Fig. 1.2V.8: Power dissipation vs. load current and ambient temperature for SQ24T/S15012 converter mounted vertically with V_{in} = 24V and air flowing from pin 3 to pin 1 at a rate of 200 LFM (1.0 m/s).



Fig. 1.2V.9: Turn-on transient at full rated load current (resistive) with no output capacitor at V_{in} = 24V, triggered via ON/OFF pin. Top trace: ON/OFF signal (5 V/div.). Bottom trace: output voltage (0.5 V/div.). Time scale: 1 ms/div.



Fig. 1.2V.10: Turn-on transient at full rated load current (resistive) plus 10,000 µF at V_{in} = 24V, triggered via ON/OFF pin. Top trace: ON/OFF signal (5 V/div.). Bottom trace: output voltage (0.5 V/div.). Time scale: 1 ms/div.



Fig. 1.2V.11: Output voltage response to load current step-change (3.75 A – 7.5 A – 3.75 A) at V_{in} = 24V. Top trace: output voltage (100 mV/div.). Bottom trace: load current (5 A/div.). Current slew rate: 0.1 A/µs. C_o = 1 µF ceramic. Time scale: 0.2 ms/div.



Fig. 1.2V.12: Output voltage response to load current step-change (3.75 A – 7.5 A – 3.75 A) at V_{in} = 24V. Top trace: output voltage (100 mV/div.). Bottom trace: load current (5 A/div.). Current slew rate: 5 A/µs. C_o = 450 µF tantalum + 1 µF ceramic. Time scale: 0.2 ms/div.



Fig. 1.2V.13: Output voltage ripple (20 mV/div.) at full rated load current into a resistive load with $C_o = 10 \mu\text{F}$ tantalum + 1 μF ceramic and $V_{in} = 24 \text{ V}$. Time scale: 1 $\mu\text{s}/\text{div}$.



Fig. 1.2V.14: Test setup for measuring input reflected ripple currents, i_c and i_s .



Fig. 1.2V.15: Input reflected ripple current, i_c (100 mA/div.), measured at input terminals at full rated load current and $V_{in} = 24 \text{ V}$. Refer to Fig. 1.2V.14 for test setup. Time scale: 1 $\mu\text{s}/\text{div}$.



Fig. 1.2V.16: Input reflected ripple current, i_s (10 mA/div.), measured through 10 μH at the source at full rated load current and $V_{in} = 24 \text{ V}$. Refer to Fig. 1.2V.14 for test setup. Time scale: 1 $\mu\text{s}/\text{div}$.



Fig. 1.2V.17: Output voltage vs. load current showing current limit point and converter shutdown point. Input voltage has almost no effect on current limit characteristic.



Fig. 1.2V.18: Load current (top trace, 20 A/div., 20 ms/div.) into a 10 $\text{m}\Omega$ short circuit during restart, at $V_{in} = 24 \text{ V}$. Bottom trace (20 A/div., 2 ms/div.) is an expansion of the on-time portion of the top trace.

15 ELECTRICAL SPECIFICATIONS: SQ24T/S15010 (1.0 VOLT OUT)Conditions: T_A = 25 °C, Airflow = 300 LFM (1.5 m/s), V_{in} = 24 VDC, V_{out} = 1.0 VDC unless otherwise specified.

PARAMETER	NOTES	MIN	TYP	MAX	UNITS
Input Characteristics					
Maximum Input Current	15 ADC, 1.0 VDC Out @ 18 VDC In			1.1	ADC
Input Stand-by Current	V _{in} = 24 V, converter disabled		2.6		mADC
Input No Load Current (0 load on the output)	V _{in} = 24 V, converter enabled		43		mADC
Input Reflected-Ripple Current	25 MHz bandwidth		7.5		mA _{PK-PK}
Input Voltage Ripple Rejection	120 Hz		TBD		dB
Output Characteristics					
Output Voltage Set Point (no load)		0.990	1.000	1.010	VDC
Output Regulation	Over Line		±1	±2	mV
	Over Load		±1	±3	mV
Output Voltage Range	Over line, load and temperature (-40°C to 85°C)	0.985		1.015	VDC
Output Ripple and Noise - 25 MHz bandwidth	Full load + 10 µF tantalum + 1 µF ceramic		30	50	mV _{PK-PK}
External Load Capacitance	Plus full load (resistive)			15,000	µF
Output Current Range		0		15	ADC
Current Limit Inception	Non-latching		18	20	ADC
Peak Short-Circuit Current	Non-latching. Short = 10 mΩ.		30	40	A
RMS Short-Circuit Current	Non-latching			5.3	Arms
Dynamic Response					
Load Change 25% of I _{out} Max, di/dt = 0.1 A/µs	Co = 1 µF ceramic		80		mV
	di/dt = 5 A/µs Co = 450 µF tant. + 1 µF ceramic		140		mV
Setting Time to 1%			180		µs
Efficiency					
100% Load			79		%
50% Load			79		%



Fig. 1.0V.1: Available load current vs. ambient air temperature and airflow rates for SQ24T15010 converter with B height pins mounted vertically with $V_{in} = 24V$, air flowing from pin 3 to pin 1 and maximum FET temperature $\leq 120^{\circ}C$.



Fig. 1.0V.2: Available load current vs. ambient air temperature and airflow rates for SQ24T15010 converter with B height pins mounted horizontally with $V_{in} = 24V$, air flowing from pin 3 to pin 1 and maximum FET temperature $\leq 120^{\circ}C$.



Fig. 1.0V.3: Available load current vs. ambient temperature and airflow rates for SQ24S15010 converter mounted vertically with $V_{in} = 24V$, air flowing from pin 3 to pin 1 and maximum FET temperature $\leq 120^{\circ}C$.



Fig. 1.0V.4: Available load current vs. ambient temperature and airflow rates for SQ24S15010 converter mounted horizontally with $V_{in} = 24V$, air flowing from pin 3 to pin 1 and maximum FET temperature $\leq 120^{\circ}C$.



Fig. 1.0V.5: Efficiency vs. load current and input voltage for SQ24T/S15010 converter mounted vertically with air flowing from pin 3 to pin 1 at a rate of 300 LFM (1.5 m/s) and $T_a = 25^{\circ}C$.



Fig. 1.0V.6: Efficiency vs. load current and ambient temperature for SQ24T/S15010 converter mounted vertically with $V_{in} = 24V$ and air flowing from pin 3 to pin 1 at a rate of 200 LFM (1.0 m/s).

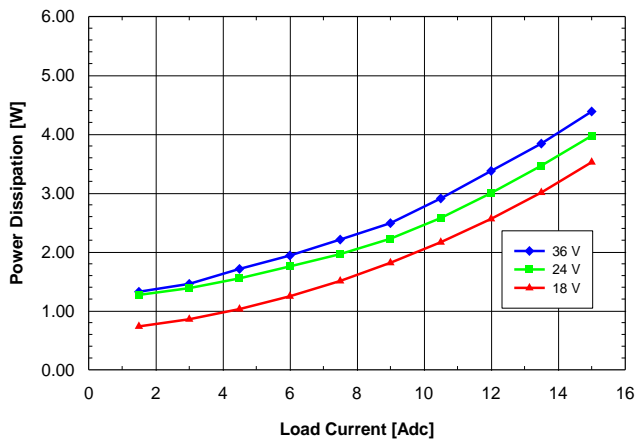

Fig. 1.0V.7: Power dissipation vs. load current and input voltage for SQ24T/S15010 converter mounted vertically with air flowing from pin 3 to pin 1 at a rate of 300 LFM (1.5 m/s) and $T_a = 25^\circ\text{C}$.

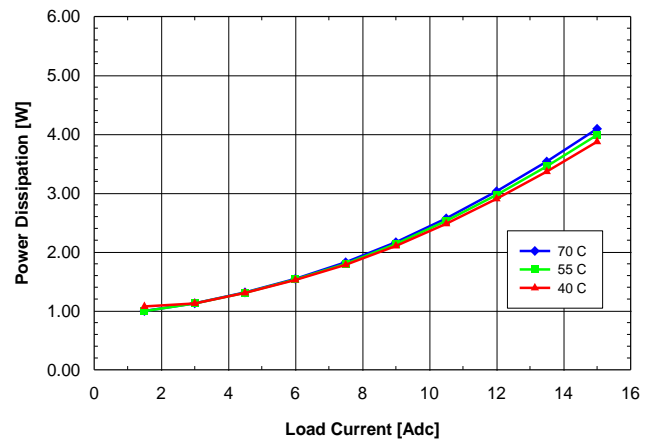

Fig. 1.0V.8: Power dissipation vs. load current and ambient temperature for SQ24T/S15010 converter mounted vertically with $V_{in} = 24\text{V}$ and air flowing from pin 3 to pin 1 at a rate of 200 LFM (1.0 m/s).

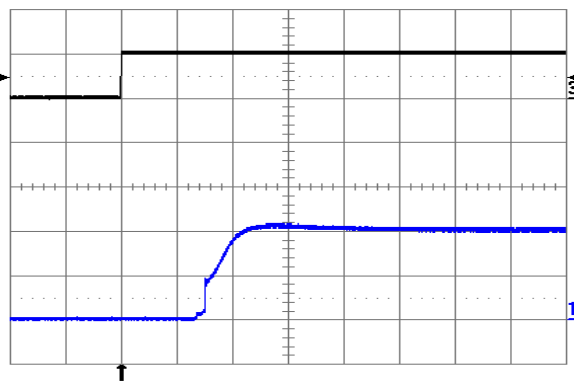

Fig. 1.0V.9: Turn-on transient at full rated load current (resistive) with no output capacitor at $V_{in} = 24\text{V}$, triggered via ON/OFF pin. Top trace: ON/OFF signal (5 V/div.). Bottom trace: output voltage (0.5 V/div.). Time scale: 1 ms/div.

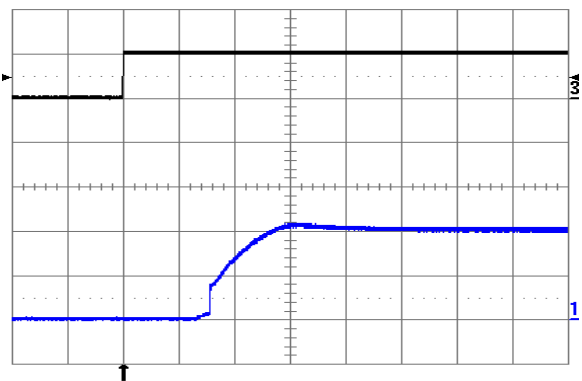

Fig. 1.0V.10: Turn-on transient at full rated load current (resistive) plus 10,000µF at $V_{in} = 24\text{V}$, triggered via ON/OFF pin. Top trace: ON/OFF signal (5 V/div.). Bottom trace: output voltage (0.5 V/div.). Time scale: 1 ms/div.



Fig. 1.0V.10: Turn-on transient at full rated load current (resistive) plus 10,000µF at $V_{in} = 24\text{V}$, triggered via ON/OFF pin. Top trace: ON/OFF signal (5 V/div.). Bottom trace: output voltage (0.5 V/div.). Time scale: 1 ms/div.



Fig. 1.0V.12: Output voltage response to load current step-change (3.75 A – 7.5 A – 3.75 A) at $V_{in} = 24\text{V}$. Top trace: output voltage (100 mV/div.). Bottom trace: load current (5 A/div.). Current slew rate: 5 A/µs. $C_o = 450\ \mu\text{F}$ tantalum + 1 µF ceramic. Time scale: 0.2 ms/div.

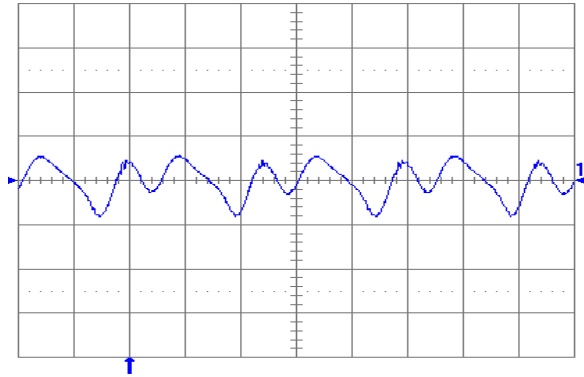

Fig. 1.0V.13: Output voltage ripple (20 mV/div.) at full rated load current into a resistive load with $C_o = 10 \mu\text{F}$ tantalum + $1\mu\text{F}$ ceramic and $V_{in} = 24 \text{ V}$. Time scale: $1 \mu\text{s}/\text{div}$.

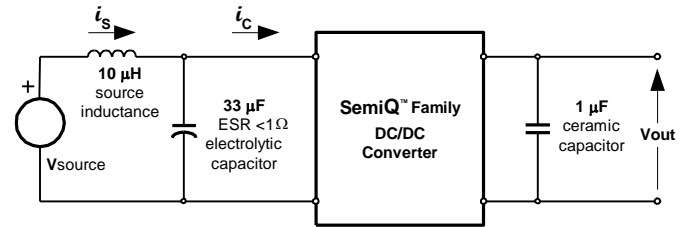

Fig. 1.0V.14: Test setup for measuring input reflected ripple currents, i_c and i_s .

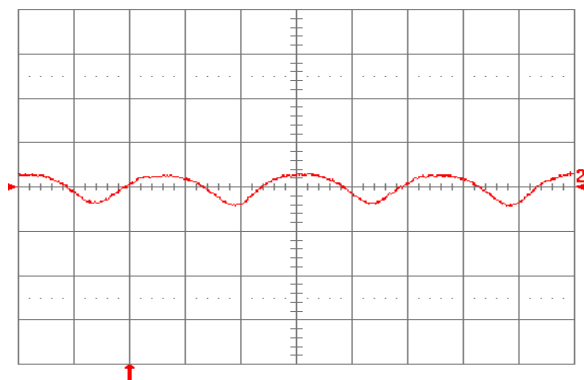

Fig. 1.0V.15: Input reflected ripple current, i_c (100 mA/div.), measured at input terminals at full rated load current and $V_{in} = 24 \text{ V}$. Refer to Fig. 1.0V.14 for test setup. Time scale: $1 \mu\text{s}/\text{div}$.

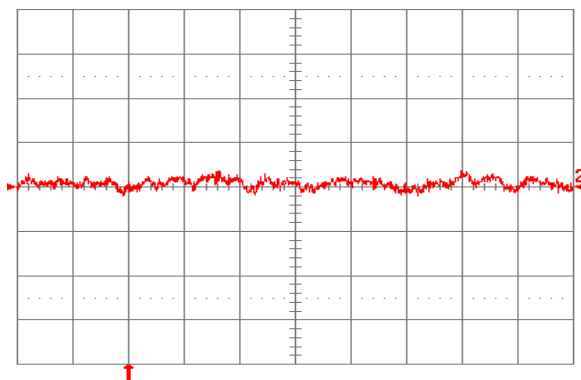

Fig. 1.0V.16: Input reflected ripple current, i_s (10 mA/div.), measured through $10 \mu\text{H}$ at the source at full rated load current and $V_{in} = 24 \text{ V}$. Refer to Fig. 1.0V.14 for test setup. Time scale: $1 \mu\text{s}/\text{div}$.

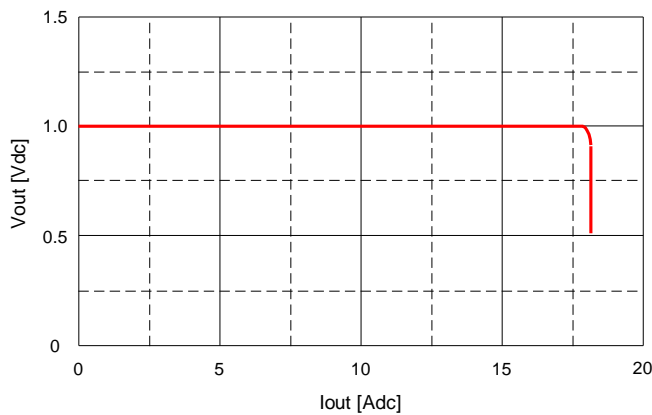

Fig. 1.0V.17: Output voltage vs. load current showing current limit point and converter shutdown point. Input voltage has almost no effect on current limit characteristic.

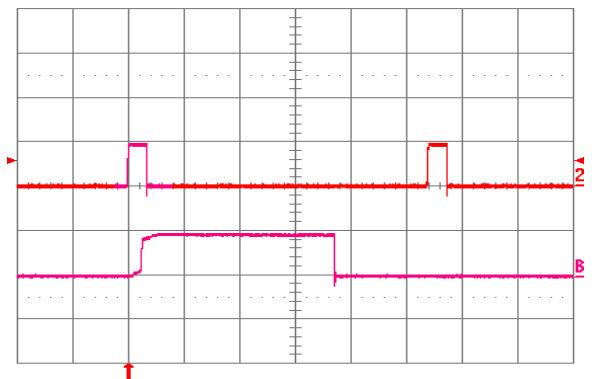
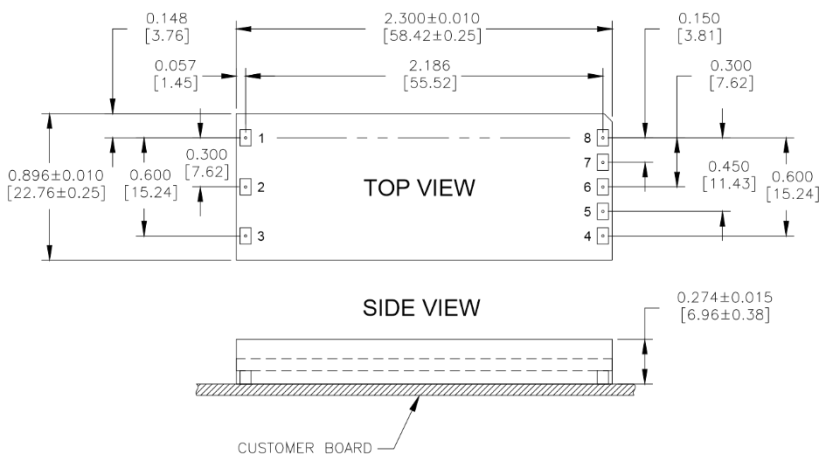
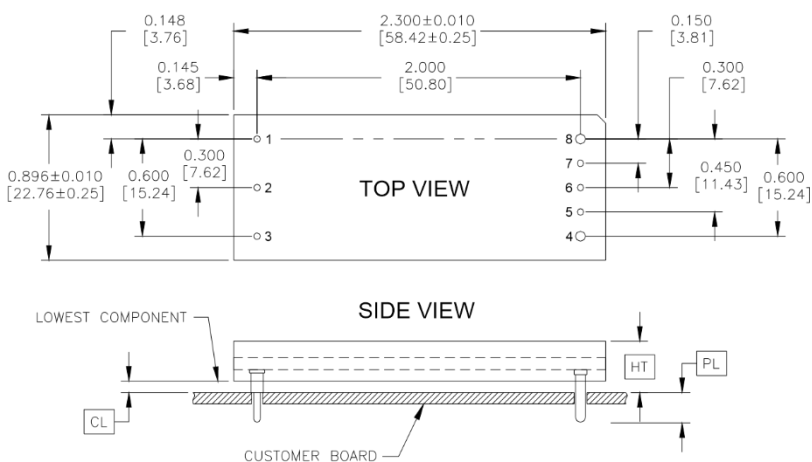

Fig. 1.0V.18: Load current (top trace, 20 A/div., 20 ms/div.) into a $10 \text{ m}\Omega$ short circuit during restart, at $V_{in} = 24 \text{ V}$. Bottom trace (20 A/div., 2 ms/div.) is an expansion of the on-time portion of the top trace.

16 MECHANICAL SPECIFICATIONS



SQ24S Pinout (Surface Mount)



SQ24T Pinout (Through-hole)

SQ24S Platform Notes

- All dimensions are in inches [mm]
- Connector Material: Copper
- Connector Finish: Gold over Nickel
- Optional: Tin/Lead over Nickel
- Converter Weight: 0.53 oz [15 g]
- Recommended Surface-Mount Pads:
 - Min. 0.080" X 0.112" [2.03 x 2.84]
 - Max. 0.092" X 0.124" [2.34 x 3.15]

PAD / PIN CONNECTIONS	
Pad/Pin #	Function
1	Vin (+)
2	ON/OFF
3	Vin (-)
4	Vout (-)
5	SENSE(-)
6	TRIM
7	SENSE(+)
8	Vout (+)

Height Option	HT	CL
	(Max. Height)	(Min. Clearance)
	+0.000 [+0.00] - 0.038 [- 0.97]	+0.016 [+0.41] - 0.000 [- 0.00]
A	0.319 [8.10]	0.030 [0.77]
B	0.352 [8.94]	0.063 [1.60]
C	0.516 [13.11]	0.227 [5.77]
D	0.416 [10.57]	0.127 [3.23]
E	0.298 [7.57]	0.009 [0.23]

Pin Option	PL Pin Length
	±0.005 [±0.13]
A	0.188 [4.77]
B	0.145 [3.68]
C	0.110 [2.79]

SQ24T Platform Notes

- All dimensions are in inches [mm]
- Pins 1-3 and 5-7 are Ø 0.040" [1.02] with Ø 0.078" [1.98] shoulder
- Pins 4 and 8 are Ø 0.062" [1.57] without shoulder
- Pin Material and Finish: CDA 360 (brass) with 200-300 u" matte SN over 100-150 u" N
- Converter Weight: 0.53 oz [15 g]

17 CONVERTER PART NUMBERING / ORDERING INFORMATION

Product Series	Input Voltage	Mounting Scheme	Rated Load Current	Output Voltage	ON/OFF Logic	Maximum Height [HT]	Pin Length [PL]	Special Features	RoHS
SQ	24	S	05	080	-	N	S	0	0
1/8 th Brick Format	18-36 V	S ⇒ Surface Mount	15 ⇒ 15 A (1.0 – 3.3 V)	010 ⇒ 1.0 V	N ⇒ Negative P ⇒ Positive	<u>SMT</u> S ⇒ 0.289"	<u>SMT</u> 0 ⇒ 0.00"	S ⇒ Optional Connector Finish: Tin/Lead over Nickel	No Suffix ⇒ RoHS lead-solder- exemption compliant
			10 ⇒ 10 A (5.0 V)	012 ⇒ 1.2 V				T ⇒ Special Trim ² (For 1.2V & 1.0V only)	G ⇒ RoHS compliant for all six substances
			08 ⇒ 8 A (6.0 V)	015 ⇒ 1.5 V					
			05 ⇒ 5.3 A (8.0 V)	018 ⇒ 1.8 V					
			04 ⇒ 4 A (12.0 V)	020 ⇒ 2.0 V					

Product Series ³	Input Voltage	Mounting Scheme	Rated Load Current	Output Voltage	ON/OFF Logic	Maximum Height [HT]	Pin Length [PL]	Special Features	RoHS
SQ	24	T	05	080	-	N	B	A	0
1/8 th Brick Format	18-36 V	T ⇒ Through- hole	15 ⇒ 15 A (1.0 – 3.3 V)	010 ⇒ 1.0 V	N ⇒ Negative P ⇒ Positive	<u>Through hole</u> A ⇒ 0.319" B ⇒ 0.352" C ⇒ 0.516" D ⇒ 0.416" E ⇒ 0.298"	<u>Through hole</u> A ⇒ 0.188" B ⇒ 0.145" C ⇒ 0.110"	0 ⇒ STD	No Suffix ⇒ RoHS lead-solder- exemption compliant
			10 ⇒ 10 A (5.0 V)	012 ⇒ 1.2 V				T ⇒ Special Trim ² (For 1.2V & 1.0V only)	
			08 ⇒ 8 A (6.0 V)	015 ⇒ 1.5 V				H ⇒ Flexible termination of C406 (max height 2.5 mm)	
			05 ⇒ 5.3 A (8.0 V)	018 ⇒ 1.8 V					
			04 ⇒ 4 A (12.0 V)	020 ⇒ 2.0 V					

¹ The example above describes P/N SQ24T05080-NBA0: 18-36 V input, through-hole mounting, 5.3 A @ 8.0 V output, negative ON/OFF logic, a maximum height of 0.352", a through the board pin length of 0.188", and RoHS lead-solder-exemption compliance. Please consult factory regarding availability of a specific version.

² For definitions, operation, and associated trim equations for all trim options please refer to Application Note 103, Trim Feature for Isolated DC-DC converters.

³ All possible option combinations are not necessarily available for every model. Contact Customer Service to confirm availability.

Model numbers highlighted in yellow or shaded are not recommended for new designs.

For more information on these products consult: tech.support@psbel.com

NUCLEAR AND MEDICAL APPLICATIONS - Products are not designed or intended for use as critical components in life support systems, equipment used in hazardous environments, or nuclear control systems.

TECHNICAL REVISIONS - The appearance of products, including safety agency certifications pictured on labels, may change depending on the date manufactured. Specifications are subject to change without notice.





Asia-Pacific
+86 755 298 85888

Europe, Middle East
+353 61 225 977

North America
+1 408 785 5200

Looking for pricing, stock, or lifecycle information?

Click below to explore more details on WIN SOURCE:

-  [View SQ24T10050-PEC0G on WIN SOURCE](#)
-  [Bel Power Solutions Information](#)

Optimize Your Supply Chain with WIN SOURCE Solutions

-  Global Sourcing Solution
-  Obsolete Management
-  Cost Control Management
-  Shortage Management
-  Alternative Solution
-  Excess Inventory Management