



# SQ48 DC-DC Series

## 36-75 VDC Input; 1.0-12 VDC Output

The SemiQ™ Series of dc-dc converters provides a high-efficiency single output in a size that is only 60% of industry-standard quarter-bricks, while preserving the same pinout and functionality.

In high temperature environments, for output voltages ranging from 3.3 V to 1.0 V, the thermal performance of SemiQ™ converters exceeds that of most competitors' 20-25 A quarter-bricks. This performance is accomplished through the use of patent-pending circuit, packaging, and processing techniques to achieve ultra-high efficiency, excellent thermal management, and a very low body profile.

Low body profile and the preclusion of heat sinks minimize airflow shadowing, thus enhancing cooling for downstream devices. The use of 100% automation for assembly, coupled with advanced electronic circuits and thermal design, results in a product with extremely high reliability.

Operating from a 36-75 V input, the SQ48 Series converters provide any standard output voltage from 12 V down to 1.0 V. Outputs can be trimmed from -20% to +10% of the nominal output voltage ( $\pm 10\%$  for output voltages 1.2 V and 1.0 V), thus providing outstanding design flexibility.

With a standard pinout and trim equations, the SQ48 Series converters are perfect drop-in replacements for existing quarter-brick designs. Inclusion of this converter in new designs can result in significant board space and cost savings. In both cases the designer can expect reliability improvement over other available converters because of the SQ48 Series' optimized thermal efficiency.



### Key Features & Benefits

- Delivers up to 15A (50W)
- Industry-standard quarter-brick pinout
- Outputs available in 12.0, 8.0, 6.0, 5.0, 3.3, 2.5, 2.0, 1.8, 1.5, 1.2, and 1.0 V
- Available in through-hole and SMT packages
- On-board input differential LC-filter
- Startup into pre-biased output
- No minimum load required
- Withstands 100 V input transient for 100 ms
- Fixed-frequency operation
- Fully protected
- Remote output sense
- Positive or negative logic ON/OFF option
- Output voltage trim range: +10%/-20% with industry-standard trim equations (except 1.2 V and 1.0 V outputs with trim range  $\pm 10\%$ )
- Output voltage trim range: +10%/-20% with industry-standard trim equations (except 1.2 V and 1.0 V outputs with trim range  $\pm 10\%$ )
- Approved to latest edition/revision of UL/CSA 60950-1, EN60950-1 and IEC 60950-1
- Designed to meet Class B conducted emissions per FCC and EN55022 when used with external filter
- All materials meet UL94, V-0 flammability rating



**bel** POWER SOLUTIONS & PROTECTION

a bel group

[belpowersolutions.com](http://belpowersolutions.com)

## 1. ELECTRICAL SPECIFICATIONS

Conditions: TA = 25 °C, Airflow = 300 LFM (1.5 m/s), Vin = 48 VDC, Cin=33 µF, unless otherwise specified.

PARAMETER	CONDITIONS/DESCRIPTION	MIN	TYP	MAX	UNITS
<b>Absolute Maximum Ratings</b>					
Input Voltage	Continuous	0		80	VDC
Operating Ambient Temperature		-40		85	°C
Storage Temperature		-55		125	°C
<b>Input Characteristics</b>					
Operating Input Voltage Range		36	48	75	VDC
Input Undervoltage Lockout	Non-latching				
Turn-on Threshold		33	34	35	VDC
Turn-off Threshold		31	32	33	VDC
Input Voltage Transient	100 ms			100	VDC
<b>Isolation Characteristics</b>					
I/O Isolation		2000			VDC
Isolation Capacitance	1.0 - 3.3 V		160		pF
	5.0 - 6.0 V		260		pF
	8.0 - 12 V		230		pF
Isolation Resistance		10			MΩ
<b>Feature Characteristics</b>					
Switching Frequency			415		kHz
Output Voltage Trim Range <sup>1</sup>	Industry-std. equations (1.5 - 12V)	-20		+10	%
	Use trim equation on Page 4 (1.0 -1.2 V)	-10		+10	%
Remote Sense Compensation <sup>1</sup>	Percent of V <sub>OUT</sub> (NOM)			+10	%
Output Overvoltage Protection	Non-latching ( 1.5 – 12 V)	117	122	127	%
	Non-latching (1.0 -1.2 V)	124	132	140	%
Auto-Restart Period	Applies to all protection features		100		ms
Turn-On Time	See Figures 6, 7 and 8		4		ms
ON/OFF Control (Positive Logic)					
Converter Off (logic low)		-20		0.8	VDC
Converter On (logic high)		2.4		20	VDC
ON/OFF Control (Negative Logic)					
Converter Off (logic high)		2.4		20	VDC
Converter On (logic low)		-20		0.8	VDC

<sup>1</sup> V<sub>out</sub> can be increased up to 10% via the sense leads or up to 10% via the trim function. However, the total output voltage trim from all sources should not exceed 10% of V<sub>OUT</sub> (NOM), in order to ensure specified operation of overvoltage protection circuitry.

## 2. OPERATIONS

### 2.1 INPUT AND OUTPUT IMPEDANCE

These power converters have been designed to be stable with no external capacitors when used in low inductance input and output circuits.

In many applications, the inductance associated with the distribution from the power source to the input of the converter can affect the stability of the converter. The addition of a 33  $\mu\text{F}$  electrolytic capacitor with an ESR  $< 1 \Omega$  across the input helps to ensure stability of the converter. In many applications, the user has to use decoupling capacitance at the load. The power converter will exhibit stable operation with external load capacitance up to 1000  $\mu\text{F}$  on 12 V, 2,200  $\mu\text{F}$  on 8.0 V, 10,000  $\mu\text{F}$  on 5.0 – 6.0 V, and 15,000  $\mu\text{F}$  on 3.3 – 1.0 V outputs. Additionally, see the EMC section of this data sheet for discussion of other external components which may be required for control of conducted emissions.

### 2.2 ON / OFF (PIN 2)

The ON/OFF pin is used to turn the power converter on or off remotely via a system signal. There are two remote control options available, positive logic and negative logic, with both referenced to  $V_{in(-)}$ . A typical connection is shown in Fig. 1.



Figure 1. Circuit configuration for ON/OFF function

The positive logic version turns on when the ON/OFF pin is at a logic high and turns off when at a logic low. The converter is on when the ON/OFF pin is left open. See Electrical Specifications for logic high/low definitions.

The negative logic version turns on when the pin is at a logic low and turns off when the pin is at a logic high. The ON/OFF pin can be hardwired directly to  $V_{in(-)}$  to enable automatic power up of the converter without the need of an external control signal. The ON/OFF pin is internally pulled up to 5V through a resistor. A properly debounced mechanical switch, open collector transistor, or FET can be used to drive the input of the ON/OFF pin. The device must be capable of sinking up to 0.2 mA at a low level voltage of  $\leq 0.8 \text{ V}$ . An external voltage source ( $\pm 20 \text{ V}$  maximum) may be connected directly to the ON/OFF input, in which case it must be capable of sourcing or sinking up to 1 mA depending on the signal polarity. See the Startup Information section for system timing waveforms associated with use of the ON/OFF pin.

### 2.3 REMOTE SENSE (PINS 5 AND 7)

The remote sense feature of the converter compensates for voltage drops occurring between the output pins of the converter and the load. The SENSE(-) (Pin 5) and SENSE(+) (Pin 7) pins should be connected at the load or at the point where regulation is required (see Fig. 2).



Figure 2. Remote sense circuit configuration

**CAUTION**

If remote sensing is not utilized, the SENSE(-) pin must be connected to the Vout(-) pin (Pin 4), and the SENSE(+) pin must be connected to the Vout(+) pin (Pin 8) to ensure the converter will regulate at the specified output voltage. If these connections are not made, the converter will deliver an output voltage that is slightly higher than the specified data sheet value.

Because the sense leads carry minimal current, large traces on the end-user board are not required. However, sense traces should be run side by side and located close to a ground plane to minimize system noise and ensure optimum performance.

When using the remote sense function, the converter's output overvoltage protection (OVP) senses the voltage across Vout(+) and Vout(-), and not across the sense lines, so the resistance (and resulting voltage drop) between the output pins of the converter and the load should be minimized to prevent unwanted triggering of the OVP.

When utilizing the remote sense feature, care must be taken not to exceed the maximum allowable output power capability of the converter, which is equal to the product of the nominal output voltage and the allowable output current for the given conditions.

When using remote sense, the output voltage at the converter can be increased by as much as 10% above the nominal rating in order to maintain the required voltage across the load. Therefore, the designer must, if necessary, decrease the maximum current (originally obtained from the derating curves) by the same percentage to ensure the converter's actual output power remains at or below the maximum allowable output power.

**2.4 OUTPUT VOLTAGE ADJUST / TRIM (PIN 6)**

The output voltage can be adjusted up 10% or down 20% for  $V_{out} \geq 1.5$  V, and 10% for  $V_{out} = 1.2$  V relative to the rated output voltage by the addition of an externally connected resistor. For output voltage 3.3 V, trim up to 10% is guaranteed only at  $V_{in} \geq 40$  V, and it is marginal (8% to 10%) at  $V_{in} = 36$  V.

The TRIM pin should be left open if trimming is not being used. To minimize noise pickup, a 0.1  $\mu$ F capacitor is connected internally between the TRIM and SENSE(-) pins.

To increase the output voltage, refer to Fig. 3. A trim resistor,  $R_{T-INCR}$ , should be connected between the TRIM (Pin 6) and SENSE(+) (Pin 7), with a value of:

$$R_{T-INCR} = \frac{5.11(100 + \Delta)V_{O-NOM} - 626}{1.225\Delta} - 10.22 \text{ [k}\Omega\text{], for } 1.5 - 12 \text{ V}$$

$$R_{T-INCR} = \frac{84.6}{\Delta} - 7.2 \text{ [k}\Omega\text{], for } 1.2 \text{ V}$$

$$R_{T-INCR} = \frac{120}{\Delta} - 9 \text{ [k}\Omega\text{], for } 1.0 \text{ V}$$

where,

$R_{T-INCR}$  = Required value of trim-up resistor  $k\Omega$

$V_{O-NOM}$  = Nominal value of output voltage [V]

$$\Delta = \left| \frac{(V_{O-REQ} - V_{O-NOM})}{V_{O-NOM}} \right| \times 100 \text{ [%]}$$

$V_{O-REQ}$  = Desired (trimmed) output voltage [V].



Figure 3. Configuration for increasing output voltage

When trimming up, care must be taken not to exceed the converter's maximum allowable output power. See the previous section for a complete discussion of this requirement.

To decrease the output voltage (Fig. 4), a trim resistor,  $R_{T-DECR}$ , should be connected between the TRIM (Pin 6) and SENSE(-) (Pin 5), with a value of:

$$R_{T-DECR} = \frac{511}{\Delta} - 10.22 \quad [\text{k}\Omega] \text{ for } 1.5 - 12 \text{ V}$$

$$R_{T-DECR} = \frac{700}{\Delta} - 15 \quad [\text{k}\Omega] \text{ for } 1.2 \text{ V}$$

$$R_{T-DECR} = \frac{700}{|\Delta|} - 17 \quad [\text{k}\Omega] \text{ for } 1.0 \text{ V}$$

where,

$R_{T-DECR}$  = Required value of trim-down resistor [kΩ] and  $\Delta$  is defined above.

Note:

The above equations for calculation of trim resistor values match those typically used in conventional industry-standard quarter-bricks and one-eighth bricks (except for 1.2 V and 1.0 V outputs).

Converters with output voltages 1.2 V and 1.0 V are available with alternative trim feature to provide the customers with the flexibility of second sourcing. These converters have a “T” character in the part number. The trim equations of “T” version of converters and more information can be found in Application Note 103.



Figure 4. Configuration for decreasing output voltage

Trimming/sensing beyond 110% of the rated output voltage is not an acceptable design practice, as this condition could cause unwanted triggering of the output overvoltage protection (OVP) circuit. The designer should ensure that the difference between the voltages across the converter’s output pins and its sense pins does not exceed 10% of  $V_{OUT(nom)}$ , or:

$$[V_{OUT(+)} - V_{OUT(-)}] - [V_{SENSE(+)} - V_{SENSE(-)}] \leq V_{O-NOM} \times 10\% [V]$$

This equation is applicable for any condition of output sensing and/or output trim.

## 3. PROTECTION FEATURES

### 3.1 INPUT UNDERVOLTAGE LOCKOUT

Input undervoltage lockout is standard with this converter. The converter will shut down when the input voltage drops below a pre-determined voltage.

The input voltage must be typically 34 V for the converter to turn on. Once the converter has been turned on, it will shut off when the input voltage drops typically below 32 V. This feature is beneficial in preventing deep discharging of batteries used in telecom applications.

### 3.2 OUTPUT OVERCURRENT PROTECTION (OCP)

The converter is protected against overcurrent or short circuit conditions. Upon sensing an overcurrent condition, the converter will switch to constant current operation and thereby begin to reduce output voltage. When the output voltage drops below 50% of the nominal value of output voltage, the converter will shut down (Fig. x.17).

Once the converter has shut down, it will attempt to restart nominally every 100 ms with a typical 1-2% duty cycle (Fig. x.18). The attempted restart will continue indefinitely until the overload or short circuit conditions are removed or the output voltage rises above 50% of its nominal value.

Once the output current is brought back into its specified range, the converter automatically exits the hiccup mode and continues normal operation.



a bel group

Asia-Pacific  
+86 755 298 85888

Europe, Middle East  
+353 61 225 977

North America  
+1 408 785 5200

### 3.3 OUTPUT OVERVOLTAGE PROTECTION (OVP)

The converter will shut down if the output voltage across Vout(+) (Pin 8) and Vout(-) (Pin 4) exceeds the threshold of the OVP circuitry. The OVP circuitry contains its own reference, independent of the output voltage regulation loop. Once the converter has shut down, it will attempt to restart every 100 ms until the OVP condition is removed.

### 3.4 OVERTEMPERATURE PROTECTION (OTP)

The converter will shut down under an overtemperature condition to protect itself from overheating caused by operation outside the thermal derating curves, or operation in abnormal conditions such as system fan failure. After the converter has cooled to a safe operating temperature, it will automatically restart.

### 3.5 SAFETY REQUIREMENTS

The converters meet North American and International safety regulatory requirements. Basic Insulation is provided between input and output.

To comply with safety agencies' requirements, an input line fuse must be used external to the converter. The Table below provides the recommended fuse rating for use with this family of products.

OUTPUT VOLTAGE	FUSE RATING
3.3 V	4 A
12 – 5.0 V, 2.5 V	3 A
2.0 – 1.2 V	2 A

All SQ converters are UL approved for a maximum fuse rating of 15 Amps. To protect a group of converters with a single fuse, the rating can be increased from the recommended values above.

### 3.6 ELECTROMAGNETIC COMPATIBILITY (EMC)

EMC requirements must be met at the end-product system level, as no specific standards dedicated to EMC characteristics of board mounted component dc-dc converters exist. However, Bel Power Solutions tests its converters to several system level standards, primary of which is the more stringent EN55022, Information technology equipment - Radio disturbance characteristics - Limits and methods of measurement.

An effective internal LC differential filter significantly reduces input reflected ripple current, and improves EMC.

With the addition of a simple external filter (see Application Note 100), all versions of the SQ48 Series converters pass the requirements of Class B conducted emissions per EN55022 and FCC requirements. Please contact Bel Power Solutions Applications Engineering for details of this testing.

## 4. CHARACTERIZATION

### 4.1 GENERAL INFORMATION

The converter has been characterized for many operational aspects, to include thermal derating (maximum load current as a function of ambient temperature and airflow) for vertical and horizontal mounting, efficiency, startup and shutdown parameters, output ripple and noise, transient response to load step-change, overload, and short circuit.

The figures are numbered as Fig. x.y, where x indicates the different output voltages, and y associates with specific plots (y = 1 for the vertical thermal derating). For example, Fig. x.1 will refer to the vertical thermal derating for all the output voltages in general.

The following pages contain specific plots or waveforms associated with the converter. Additional comments for specific data are provided below.

### 4.2 TEST CONDITIONS

All data presented were taken with the converter soldered to a test board, specifically a 0.060" thick printed wiring board (PWB) with four layers. The top and bottom layers were not metalized. The two inner layers, comprised of two-ounce copper, were used to provide traces for connectivity to the converter.

The lack of metalization on the outer layers as well as the limited thermal connection ensured that heat transfer from the converter to the PWB was minimized. This provides a worst-case but consistent scenario for thermal derating purposes.

All measurements requiring airflow were made in the vertical and horizontal wind tunnel using Infrared (IR) thermography and thermocouples for thermometry.

Ensuring components on the converter do not exceed their ratings is important to maintaining high reliability. If one anticipates operating the converter at or close to the maximum loads specified in the derating curves, it is prudent to check actual operating temperatures in the application. Thermographic imaging is preferable; if this capability is not available, then thermocouples may be used. The use of AWG #40 gauge thermocouples is recommended to ensure measurement accuracy. Careful routing of the thermocouple leads will further minimize measurement error. Refer to Fig. 5 for the optimum measuring thermocouple location.



Figure 5. Location of the thermocouple for thermal testing

## 4.3 THERMAL DERATING

Load current vs. ambient temperature and airflow rates are given in Fig. x.1 to Fig. x.4 for through-hole and surface-mount versions. Ambient temperature was varied between 25°C and 85°C, with airflow rates from 30 to 500LFM (0.15 to 2.5m/s), and vertical and horizontal converter mounting.

For each set of conditions, the maximum load current was defined as the lowest of:

- (i) The output current at which any FET junction temperature does not exceed a maximum specified temperature (120°C) as indicated by the thermographic image, or
- (ii) The nominal rating of the converter (4A on 12V, 5.3A on 8.0V, 8A on 6.0V, 10A on 5.0V, and 15A on 3.3 – 1.0V).

During normal operation, derating curves with maximum FET temperature less or equal to 120 °C should not be exceeded. Temperature on the PCB at thermocouple location shown in Fig. E should not exceed 118 °C in order to operate inside the derating curves.

## 4.4 EFFICIENCY

Fig. x.5 shows the efficiency vs. load current plot for ambient temperature of 25°C, airflow rate of 300 LFM (1.5 m/s) with vertical mounting and input voltages of 36V, 48V and 72V. Also, a plot of efficiency vs. load current, as a function of ambient temperature with  $V_{in} = 48V$ , airflow rate of 200 LFM (1 m/s) with vertical mounting is shown in Fig. x.6.

## 4.5 POWER DISSIPATION

Fig. x.7 shows the power dissipation vs. load current plot for  $T_a = 25^\circ C$ , airflow rate of 300LFM (1.5 m/s) with vertical mounting and input voltages of 36V, 48V and 72V. Also, a plot of power dissipation vs. load current, as a function of ambient temperature with  $V_{in} = 48V$ , airflow rate of 200LFM (1 m/s) with vertical mounting is shown in Fig. x.8.

## 4.6 STARTUP

Output voltage waveforms, during the turn-on transient using the ON/OFF pin for full rated load currents (resistive load) are shown without and with external load capacitance in Fig. x.9 and Fig. x.10, respectively.

## 4.7 RIPPLE AND NOISE

Fig. x.13 shows the output voltage ripple waveform, measured at full rated load current with a 10  $\mu F$  tantalum and 1  $\mu F$  ceramic capacitor across the output. Note that all output voltage waveforms are measured across a 1  $\mu F$  ceramic capacitor.

The input reflected ripple current waveforms are obtained using the test setup shown in Fig x.14. The corresponding waveforms are shown in Fig. x.15 and Fig. x.16.

**Scenario #1: Initial Startup From Bulk Supply**

ON/OFF function enabled, converter started via application of  $V_{IN}$ . See Figure 6.

Time	Comments
$t_0$	ON/OFF pin is ON; system front-end power is toggled on, $V_{IN}$ to converter begins to rise.
$t_1$	$V_{IN}$ crosses undervoltage Lockout protection circuit threshold; converter enabled.
$t_2$	Converter begins to respond to turn-on command (converter turn-on delay).
$t_3$	Converter $V_{OUT}$ reaches 100% of nominal value.

For this example, the total converter startup time ( $t_3 - t_1$ ) is typically 4 ms.



Figure 6. Startup scenario #1

**Scenario #2: Initial Startup Using ON/OFF Pin**

With  $V_{IN}$  previously powered, converter started via ON/OFF pin. See Figure 7.

Time	Comments
$t_0$	$V_{INPUT}$ at nominal value.
$t_1$	Arbitrary time when ON/OFF pin is enabled (converter enabled).
$t_2$	End of converter turn-on delay.
$t_3$	Converter $V_{OUT}$ reaches 100% of nominal value.

For this example, the total converter startup time ( $t_3 - t_1$ ) is typically 4 ms.



Figure 7. Startup scenario #2

**Scenario #3: Turn-off and Restart Using ON/OFF Pin**

With  $V_{IN}$  previously powered, converter is disabled and then enabled via ON/OFF pin. See Figure 8.

Time	Comments
$t_0$	$V_{IN}$ and $V_{OUT}$ are at nominal values; ON/OFF pin ON.
$t_1$	ON/OFF pin arbitrarily disabled; converter output falls to zero; turn-on inhibit delay period (100 ms typical) is initiated, and ON/OFF pin action is internally inhibited.
$t_2$	ON/OFF pin is externally re-enabled. If $(t_2 - t_1) \leq 100$ ms, external action of ON/OFF pin is locked out by startup inhibit timer. If $(t_2 - t_1) > 100$ ms, ON/OFF pin action is internally enabled.
$t_3$	Turn-on inhibit delay period ends. If ON/OFF pin is ON, converter begins turn-on; if off, converter awaits ON/OFF pin ON signal; see Figure G.
$t_4$	End of converter turn-on delay.
$t_5$	Converter $V_{OUT}$ reaches 100% of nominal value.

For the condition,  $(t_2 - t_1) \leq 100$  ms, the total converter startup time ( $t_5 - t_2$ ) is typically 104 ms. For  $(t_2 - t_1) > 100$  ms, startup will be typically 4 ms after release of ON/OFF pin.

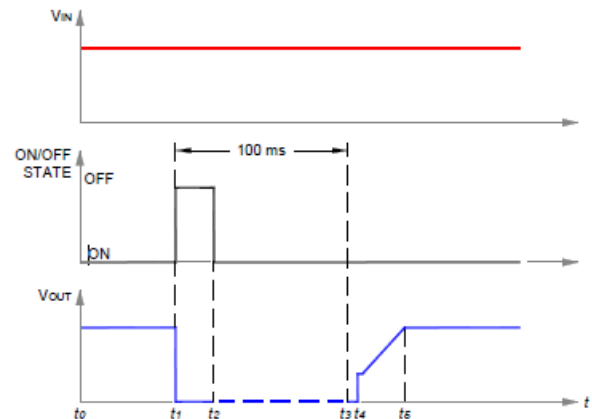

Figure 8. Startup scenario #3

## 5. ELECTRICAL SPECIFICATIONS

Conditions:  $T_A = 25\text{ }^\circ\text{C}$ , Airflow = 300 LFM (1.5 m/s),  $V_{in} = 48\text{ VDC}$ ,  $V_{out} = 12\text{ VDC}$ , unless otherwise specified.

### 5.1 SQ48T04120 (12 Volt Out)

PARAMETER	CONDITIONS/DESCRIPTION	MIN	TYP	MAX	UNITS
<i>Input Characteristics</i>					
Maximum Input Current	4 ADC, 12 VDC Out @ 36 VDC In			1.53	ADC
Input Stand-by Current	$V_{in} = 48\text{V}$ , converter disabled		3		mADC
Input No Load Current (0 load on the output)	$V_{in} = 48\text{V}$ , converter enabled		45		mADC
Input Reflected-Ripple Current	25MHz bandwidth		6		$\text{mA}_{\text{PK-PK}}$
<i>Output Characteristics</i>					
Output Voltage Set Point (no load)		11.880	12.000	12.120	VDC
Output Regulation					
Over Line			$\pm 4$	$\pm 5$	mV
Over Load			$\pm 4$	$\pm 5$	mV
Output Voltage Range	Over line, load and temperature <sup>2</sup>	11.820		12.180	VDC
Output Ripple and Noise - 25 MHz bandwidth	Full load + 10 $\mu\text{F}$ tantalum + 1 Mf ceramic		80	120	$\text{mV}_{\text{PK-PK}}$
External Load Capacitance	Plus full load (resistive)			1,000	$\mu\text{F}$
Output Current Range		0		4	ADC
Current Limit Inception	Non-latching	4.5	5	5.5	ADC
Peak Short-Circuit Current	Non-latching, Short =10 m $\Omega$ .		7.5	10	A
RMS Short-Circuit Current	Non-latching			4	Arms
<i>Dynamic Response</i>					
Load Change 25% of $I_{out}$ Max, $di/dt = 0.1\text{ A}/\mu\text{s}$	$C_o = 1\text{ }\mu\text{F}$ ceramic		200		mV
$di/dt = 5\text{ A}/\mu\text{s}$	$C_o = 47\text{ }\mu\text{F}$ tantalum + 1 $\mu\text{F}$ ceramic		200		mV
Settling Time to 1%			400		$\mu\text{s}$
<i>Efficiency</i>					
100% Load			87.0		%
50% Load			87.0		%

<sup>2</sup> -40  $^\circ\text{C}$  to 85  $^\circ\text{C}$ .

# SQ48 DC-DC Series

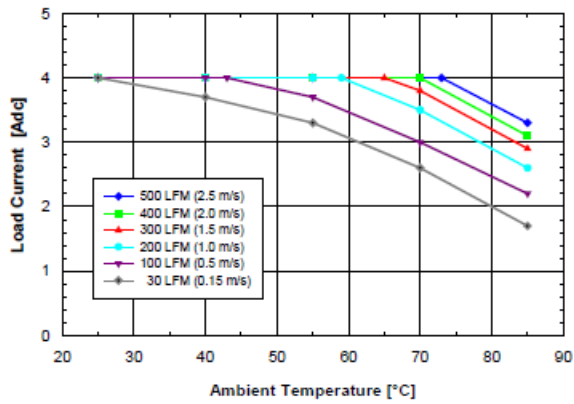

Figure 12V.1 Available load current vs. ambient air temperature and airflow rates for SQ48T04120 converter with D height pins mounted vertically with  $V_{in} = 48V$ , air flowing from pin 3 to pin 1, and maximum FET temperature  $\leq 120^{\circ}C$ .



Figure 12V.2 Available load current vs. ambient air temperature and airflow rates for SQ48T04120 converter with D height pins mounted horizontally with  $V_{in} = 48V$ , air flowing from pin 3 to pin 1, and maximum FET temperature  $\leq 120^{\circ}C$ .

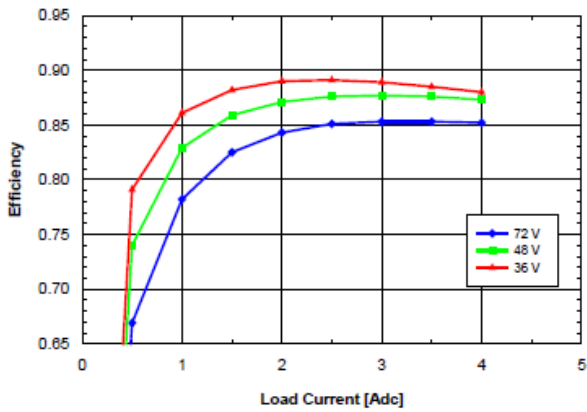

Fig. 12V.3: Efficiency vs. load current and input voltage for SQ48T/S04120 converter mounted vertically with air flowing from pin 3 to pin 1 at a rate of 300LFM (1.5 m/s) and  $T_a = 25^{\circ}C$ .



Fig. 12V.4: Efficiency vs. load current and ambient temperature for SQ48T/S04120 converter mounted vertically with  $V_{in} = 48V$  and air flowing from pin 3 to pin 1 at a rate of 200LFM (1.0 m/s).



Fig. 12V.5: Power dissipation vs. load current and input voltage for SQ48T/S04120 converter mounted vertically with air flowing from pin 3 to pin 1 at a rate of 300 LFM (1.5 m/s) and  $T_a = 25^\circ\text{C}$ .



Fig. 12V.6: Power dissipation vs. load current and ambient temperature for SQ48T/S04120 converter mounted vertically with  $V_{in} = 48\text{V}$  and air flowing from pin 3 to pin 1 at a rate of 200LFM (1.0m/s).



Fig. 12V.7: Turn-on transient at full rated load current (resistive) with no output capacitor at  $V_{in} = 48\text{V}$ , triggered via ON/OFF pin. Top trace: ON/OFF signal 5V/div.). Bottom trace: output voltage (5V/div.). Time scale: 1ms/div.



Fig. 12V.8: Turn-on transient at full rated load current (resistive) plus 1,000 µF at  $V_{in} = 48\text{V}$ , triggered via ON/OFF pin. Top trace: ON/OFF signal (5V/div.). Bottom trace: output voltage (5V/div.). Time scale: 2ms/div.



Fig. 12V.9: Output voltage response to load current step-change (1A – 2A – 1A) at  $V_{in} = 48V$ . Top trace: output voltage (200mV/div.). Bottom trace: load current (1A/div.). Current slew rate:  $0.1A/\mu s$ .  $C_o = 1\mu F$  ceramic. Time scale: 0.5 ms/div.



Fig. 12V.10: Output voltage response to load current step-change (1A – 2A – 1A) at  $V_{in} = 48V$ . Top trace: output voltage (200 mV/div.). Bottom trace: load current (1A/div.). Current slew rate:  $5 A/\mu s$ .  $C_o = 47\mu F$  tantalum +  $1\mu F$  ceramic. Time scale: 0.5 ms/div.



Fig. 12V.11: Output voltage ripple (50 mV/div.) at full rated load current into a resistive load with  $C_o = 10\mu F$  tantalum +  $1\mu F$  ceramic and  $V_{in} = 48V$ . Time scale:  $1\mu s$ /div.



Fig. 12V.12: Test Setup for measuring input reflected ripple currents,  $i_c$  and  $i_s$



Fig. 12V.13: Input reflected ripple current,  $i_c$  (100 mA/div.), measured at input terminals at full rated load current and  $V_{in} = 48V$ . Refer to Fig. 12V.14 for test setup. Time scale:  $1\mu s/div$ .



Fig. 12V.14: Input reflected ripple current,  $i_s$  (100 mA/div.), measured at input terminals at full rated full rated load current and  $V_{in} = 48V$ . Refer to Fig. 12V.14 for test setup. Time scale:  $1\mu s/div$ .



Fig. 12V.15: Output voltage vs. load current showing current limit point and converter shutdown point. Input voltage has almost no effect on current limit characteristic.



Fig. 12V.16: Load current (top trace, 5A/div., 20 ms/div.) into a  $10\ m\Omega$  short circuit during restart, at  $V_{in} = 48V$ . Bottom trace (5A/div., 1ms/div.) is an expansion of the on-time portion of the top trace.

## 5.2 SQ48T05080 (8.0 Volt Out)

Conditions:  $T_A = 25\text{ }^\circ\text{C}$ , Airflow = 300 LFM (1.5 m/s),  $V_{in} = 48\text{ VDC}$ ,  $V_{out} = 8.0\text{ VDC}$ , unless otherwise specified.

PARAMETER	CONDITIONS/DESCRIPTION	MIN	TYP	MAX	UNITS
<i>Input Characteristics</i>					
Maximum Input Current	5.3 ADC, 8.0 VDC Out @ 36 VDC In			1.38	ADC
Input Stand-by Current	$V_{in} = 48\text{V}$ , converter disabled		3		mADC
Input No Load Current (0 load on the output)	$V_{in} = 48\text{V}$ , converter enabled		33		mADC
Input Reflected-Ripple Current	25MHz bandwidth		6		$\text{mA}_{\text{PK-PK}}$
<i>Output Characteristics</i>					
Output Voltage Set Point (no load)		7.920	8.000	8.080	VDC
Output Regulation					
Over Line			$\pm 4$	$\pm 10$	mV
Over Load			$\pm 4$	$\pm 10$	mV
Output Voltage Range	Over line, load and temperature <sup>3</sup>	7.880		8.120	VDC
Output Ripple and Noise - 25 MHz bandwidth	Full load + 10 $\mu\text{F}$ tantalum + 1 $\mu\text{F}$ ceramic		70	100	$\text{mV}_{\text{PK-PK}}$
External Load Capacitance	Plus full load (resistive)			2,200	$\mu\text{F}$
Output Current Range		0		5.3	ADC
Current Limit Inception	Non-latching	5.75	6.25	6.75	ADC
Peak Short-Circuit Current	Non-latching, Short = 10 m $\Omega$ .		10	12	A
RMS Short-Circuit Current	Non-latching			4	Arms
<i>Dynamic Response</i>					
Load Change 25% of $I_{out}$ Max, $di/dt = 0.1\text{ A}/\mu\text{s}$	$C_o = 1\text{ }\mu\text{F}$ ceramic		160		mV
$di/dt = 5\text{ A}/\mu\text{s}$	$C_o = 94\text{ }\mu\text{F}$ tantalum + 1 $\mu\text{F}$ ceramic		160		mV
Settling Time to 1%			400		$\mu\text{s}$
<i>Efficiency</i>					
100% Load			85.5		%
50% Load			87.0		%

<sup>3</sup> -40  $^\circ\text{C}$  to 85  $^\circ\text{C}$ .



Figure 8.0V.1 Available load current vs. ambient air temperature and airflow rates for SQ48T05080 converter with D height pins mounted vertically with  $V_{in} = 48V$ , air flowing from pin 3 to pin 1, and maximum FET temperature  $\leq 120^{\circ}C$ .



Figure 8.0V.2 Available load current vs. ambient air temperature and airflow rates for SQ48T05080 converter with D height pins mounted horizontally with  $V_{in} = 48V$ , air flowing from pin 3 to pin 1, and maximum FET temperature  $\leq 120^{\circ}C$ .



Fig. 8.0V.3: Efficiency vs. load current and input voltage for SQ48T/S05080 converter mounted vertically with air flowing from pin 3 to pin 1 at a rate of 300LFM (1.5 m/s) and  $T_a = 25^{\circ}C$ .



Fig. 8.0V.4: Efficiency vs. load current and ambient temperature for SQ48T/S05080 converter mounted vertically with  $V_{in} = 48V$  and air flowing from pin 3 to pin 1 at a rate of 200LFM (1.0 m/s).



Fig. 8.0V.5: Power dissipation vs. load current and input voltage for SQ48T/S05080 converter mounted vertically with air flowing from pin 3 to pin 1 at a rate of 300 LFM (1.5 m/s) and  $T_a = 25^\circ\text{C}$ .



Fig. 8.0V.6: Power dissipation vs. load current and ambient temperature for SQ48T/S05080 converter mounted vertically with  $V_{in} = 48\text{V}$  and air flowing from pin 3 to pin 1 at a rate of 200LFM (1.0m/s).



Fig. 8.0V.7: Turn-on transient at full rated load current (resistive) with no output capacitor at  $V_{in} = 48\text{V}$ , triggered via ON/OFF pin. Top trace: ON/OFF signal (5V/div.). Bottom trace: output voltage (2V/div.). Time scale: 1ms/div.



Fig. 8.0V.8: Turn-on transient at full rated load current (resistive) plus 2,200 µF at  $V_{in} = 48\text{V}$ , triggered via ON/OFF pin. Top trace: ON/OFF signal (5V/div.). Bottom trace: output voltage (2V/div.). Time scale: 2ms/div.



Fig. 8.0V.9: Output voltage response to load current step-change (1.325A – 2.65A – 1.325A) at  $V_{in} = 48V$ . Top trace: output voltage (200mV/div.). Bottom trace: load current (1A/div.). Current slew rate:  $0.1A/\mu s$ .  $C_o = 1\mu F$  ceramic. Time scale: 0.5 ms/div.



Fig. 8.0V.10: Output voltage response to load current step-change (1.325A – 2.65A – 1.325A) at  $V_{in} = 48V$ . Top trace: output voltage (200 mV/div.). Bottom trace: load current (1A/div.). Current slew rate:  $5 A/\mu s$ .  $C_o = 94\mu F$  tantalum +  $1\mu F$  ceramic. Time scale: 0.5 ms/div.



Fig. 8.0V.11: Output voltage ripple (50 mV/div.) at full rated load current into a resistive load with  $C_o = 10\mu F$  tantalum +  $1\mu F$  ceramic and  $V_{in} = 48V$ . Time scale:  $1\mu s$ /div.



Fig. 8.0V.12: Test Setup for measuring input reflected ripple currents,  $i_c$  and  $i_s$

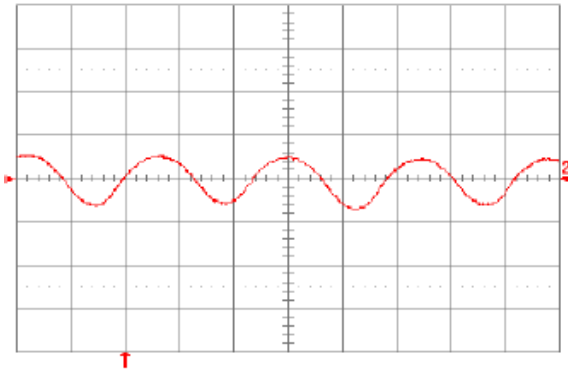

Fig. 8.0V.13: Input reflected ripple current,  $i_c$  (100 mA/div.), measured at input terminals at full rated load current and  $V_{in} = 48V$ . Refer to Fig. 8.0V.14 for test setup. Time scale: 1 $\mu$ s/div.



Fig. 8.0V.14: Input reflected ripple current,  $i_s$  (10 mA/div.), measured through 10 $\mu$ H at the source at full rated full rated load current and  $V_{in} = 48V$ . Refer to Fig. 8.0V.14 for test setup. Time scale: 1 $\mu$ s/div.



Fig. 8.0V.15: Output voltage vs. load current showing current limit point and converter shutdown point. Input voltage has almost no effect on current limit characteristic.



Fig. 8.0V.16: Load current (top trace, 5A/div., 20 ms/div.) into a 10 m $\Omega$  short circuit during restart, at  $V_{in} = 48V$ . Bottom trace (5A/div., 1ms/div.) is an expansion of the on-time portion of the top trace.

## 5.3 SQ48T/S08060 (6.0 Volt Out)

Conditions:  $T_A = 25\text{ }^\circ\text{C}$ , Airflow = 300 LFM (1.5 m/s),  $V_{in} = 48\text{ VDC}$ ,  $V_{out} = 6.0\text{ VDC}$ , unless otherwise specified.

PARAMETER	CONDITIONS/DESCRIPTION	MIN	TYP	MAX	UNITS
<b>Input Characteristics</b>					
Maximum Input Current	8 ADC, 6.0 VDC Out @ 36 VDC In			1.5	ADC
Input Stand-by Current	$V_{in} = 48\text{V}$ , converter disabled		3		mADC
Input No Load Current (0 load on the output)	$V_{in} = 48\text{V}$ , converter enabled		45		mADC
Input Reflected-Ripple Current	25MHz bandwidth		6		$\text{mA}_{\text{PK-PK}}$
<b>Output Characteristics</b>					
Output Voltage Set Point (no load)		5.940	6.000	6.060	VDC
Output Regulation					
Over Line			$\pm 2$	$\pm 10$	mV
Over Load			$\pm 2$	$\pm 10$	mV
Output Voltage Range	Over line, load and temperature <sup>4</sup>	5.910		6.090	VDC
Output Ripple and Noise - 25 MHz bandwidth	Full load + 10 $\mu\text{F}$ tantalum + 1 $\mu\text{F}$ ceramic		45	60	$\text{mV}_{\text{PK-PK}}$
External Load Capacitance	Plus full load (resistive)			10,000	$\mu\text{F}$
Output Current Range		0		8	ADC
Current Limit Inception	Non-latching	8.4	10	11.5	ADC
Peak Short-Circuit Current	Non-latching, Short = 10 m $\Omega$ .		15	25	A
RMS Short-Circuit Current	Non-latching			5.3	Arms
<b>Dynamic Response</b>					
Load Change 25% of $I_{out}$ Max, $di/dt = 0.1\text{ A}/\mu\text{s}$	$C_o = 1\text{ }\mu\text{F}$ ceramic		160		mV
$di/dt = 5\text{ A}/\mu\text{s}$	$C_o = 450\text{ }\mu\text{F}$ tantalum + 1 $\mu\text{F}$ ceramic		80		mV
Settling Time to 1%			200		$\mu\text{s}$
<b>Efficiency</b>					
100% Load			89.0		%
50% Load			89.0		%

<sup>4</sup> -40  $^\circ\text{C}$  to 85  $^\circ\text{C}$ .



Figure 6.0V.1 Available load current vs. ambient air temperature and airflow rates for SQ48T08060 converter with D height pins mounted vertically with  $V_{in} = 48V$ , air flowing from pin 3 to pin 1, and maximum FET temperature  $\leq 120^{\circ}C$ .

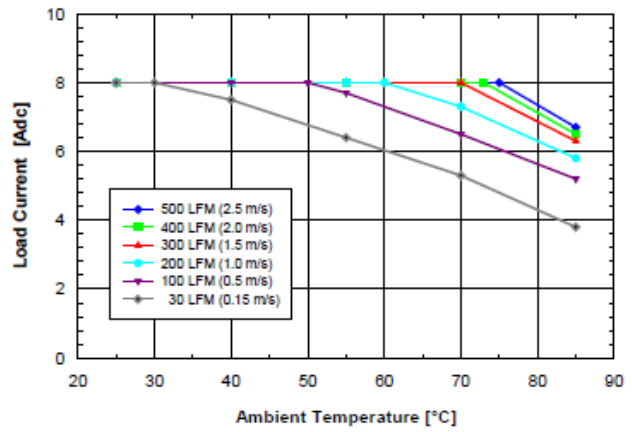

Figure 6.0V.2 Available load current vs. ambient air temperature and airflow rates for SQ48T08060 converter with D height pins mounted horizontally with  $V_{in} = 48V$ , air flowing from pin 3 to pin 1, and maximum FET temperature  $\leq 120^{\circ}C$ .



Fig. 6.0V.3: Efficiency vs. load current and input voltage for SQ48T/S08060 converter mounted vertically with air flowing from pin 3 to pin 1 at a rate of 300LFM (1.5 m/s) and  $T_a = 25^{\circ}C$ .

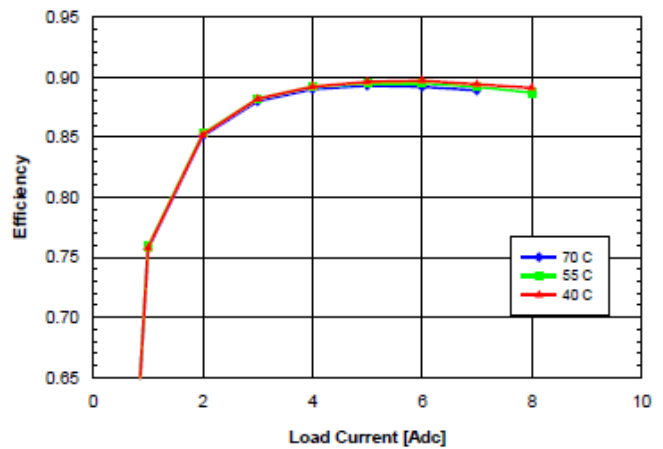

Fig. 6.0V.4: Efficiency vs. load current and ambient temperature for SQ48T/S08060 converter mounted vertically with  $V_{in} = 48V$  and air flowing from pin 3 to pin 1 at a rate of 200LFM (1.0 m/s).



Fig. 6.0V.5: Power dissipation vs. load current and input voltage for SQ48T/S08060 converter mounted vertically with air flowing from pin 3 to pin 1 at a rate of 300 LFM (1.5 m/s) and  $T_a = 25^\circ\text{C}$ .



Fig. 6.0V.6: Power dissipation vs. load current and ambient temperature for SQ48T/S08060 converter mounted vertically with  $V_{in} = 48\text{V}$  and air flowing from pin 3 to pin 1 at a rate of 200LFM (1.0m/s).



Fig. 6.0V.7: Turn-on transient at full rated load current (resistive) with no output capacitor at  $V_{in} = 48\text{V}$ , triggered via ON/OFF pin. Top trace: ON/OFF signal (5V/div.). Bottom trace: output voltage (2V/div.). Time scale: 2ms/div.

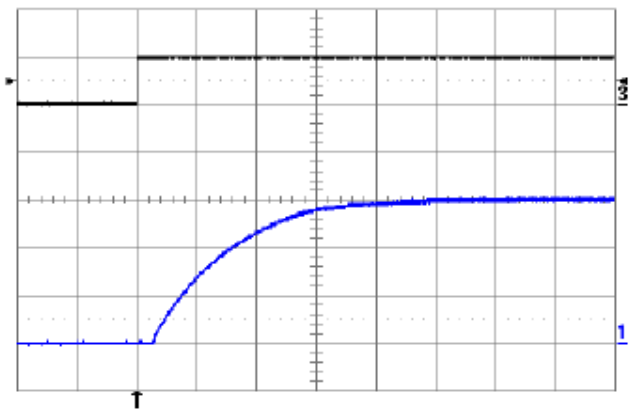

Fig. 6.0V.8: Turn-on transient at full rated load current (resistive) plus 10,000  $\mu\text{F}$  at  $V_{in} = 48\text{V}$ , triggered via ON/OFF pin. Top trace: ON/OFF signal (5V/div.). Bottom trace: output voltage (2V/div.). Time scale: 5ms/div.



Fig. 6.0V.9: Output voltage response to load current step-change (2 A – 4 A – 2 A) at  $V_{in} = 48V$ . Top trace: output voltage (100mV/div.). Bottom trace: load current (2A/div.). Current slew rate:  $0.1A/\mu s$ .  $C_o = 1\mu F$  ceramic. Time scale: 0.2 ms/div.

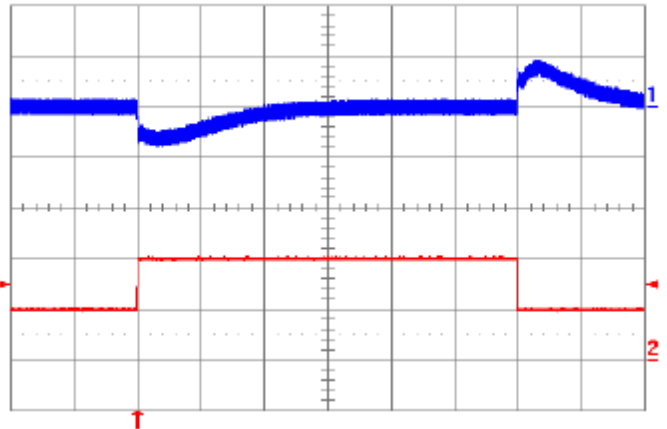

Fig. 6.0V.10: Output voltage response to load current step-change (2 A – 4 A – 2 A) at  $V_{in} = 48V$ . Top trace: output voltage (100 mV/div.). Bottom trace: load current (2A/div.). Current slew rate:  $5 A/\mu s$ .  $C_o = 450\mu F$  tantalum +  $1\mu F$  ceramic. Time scale: 0.2 ms/div.



Fig.6.0V.11: Output voltage ripple (50 mV/div.) at full rated load current into a resistive load with  $C_o = 10\mu F$  tantalum +  $1\mu F$  ceramic and  $V_{in} = 48V$ . Time scale:  $1\mu s/div$ .



Fig. 6.0V.12: Test Setup for measuring input reflected ripple currents,  $i_c$  and  $i_s$



Fig. 6.0V.13: Input reflected ripple current,  $i_c$  (100 mA/div.), measured at input terminals at full rated load current and  $V_{in} = 48V$ . Refer to Fig. 6.0V.14 for test setup. Time scale: 1 $\mu$ s/div.



Fig. 6.0V.14: Input reflected ripple current,  $i_c$  (10 mA/div.), measured through 10 $\mu$ H at the source at full rated full rated load current and  $V_{in} = 48V$ . Refer to Fig. 6.0V.14 for test setup. Time scale: 1 $\mu$ s/div.



Fig. 6.0V.15: Output voltage vs. load current showing current limit point and converter shutdown point. Input voltage has almost no effect on current limit characteristic.



Fig. 6.0V.16: Load current (top trace, 10A/div., 20 ms/div.) into a 10 m $\Omega$  short circuit during restart, at  $V_{in} = 48V$ . Bottom trace (10A/div., 1ms/div.) is an expansion of the on-time portion of the top trace.

### 5.4 SQ48T/S10050 (5.0 Volt Out)

Conditions:  $T_A = 25\text{ }^\circ\text{C}$ , Airflow = 300 LFM (1.5 m/s),  $V_{in} = 48\text{ VDC}$ ,  $V_{out} = 5.0\text{ VDC}$ , unless otherwise specified.

PARAMETER	CONDITIONS/DESCRIPTION	MIN	TYP	MAX	UNITS
<b>Input Characteristics</b>					
Maximum Input Current	10 ADC, 5.0 VDC Out @ 36 VDC In			1.65	ADC
Input Stand-by Current	$V_{in} = 48\text{V}$ , converter disabled		2.6		mADC
Input No Load Current (0 load on the output)	$V_{in} = 48\text{V}$ , converter enabled		40		mADC
Input Reflected-Ripple Current	25MHz bandwidth		6		$\text{mA}_{\text{PK-PK}}$
<b>Output Characteristics</b>					
Output Voltage Set Point (no load)		4.950	5.000	5.050	VDC
Output Regulation					
Over Line			$\pm 2$	$\pm 5$	mV
Over Load			$\pm 2$	$\pm 5$	mV
Output Voltage Range	Over line, load and temperature <sup>5</sup>	4.925		5.075	VDC
Output Ripple and Noise - 25 MHz bandwidth	Full load + 10 $\mu\text{F}$ tantalum + 1 $\mu\text{F}$ ceramic		45	80	$\text{mV}_{\text{PK-PK}}$
External Load Capacitance	Plus full load (resistive)			10,000	$\mu\text{F}$
Output Current Range		0		10	ADC
Current Limit Inception	Non-latching	10.5	12.5	14	ADC
Peak Short-Circuit Current	Non-latching, Short = 10 m $\Omega$ .		20	30	A
RMS Short-Circuit Current	Non-latching			5.3	Arms
<b>Dynamic Response</b>					
Load Change 25% of $I_{out}$ Max, $di/dt = 0.1\text{ A}/\mu\text{s}$	$C_o = 1\text{ } \mu\text{F}$ ceramic		200		mV
$di/dt = 5\text{ A}/\mu\text{s}$	$C_o = 450\text{ } \mu\text{F}$ tantalum + 1 $\mu\text{F}$ ceramic		180		mV
Settling Time to 1%			400		$\mu\text{s}$
<b>Efficiency</b>					
100% Load			87.0		%
50% Load			88.0		%

<sup>5</sup> -40  $^\circ\text{C}$  to 85  $^\circ\text{C}$ .



Figure 5.0V.1 Available load current vs. ambient air temperature and airflow rates for SQ48T10050 converter with D height pins mounted vertically with  $V_{in} = 48V$ , air flowing from pin 3 to pin 1, and maximum FET temperature  $\leq 120^{\circ}C$ .



Figure 5.0V.2 Available load current vs. ambient air temperature and airflow rates for SQ48T10050 converter with D height pins mounted horizontally with  $V_{in} = 48V$ , air flowing from pin 3 to pin 1, and maximum FET temperature  $\leq 120^{\circ}C$ .



Figure 5.0V.3 Available load current vs. ambient air temperature and airflow rates for SQ48S10050 converter with D height pins mounted vertically with  $V_{in} = 48V$ , air flowing from pin 3 to pin 1, and maximum FET temperature  $\leq 120^{\circ}C$ .

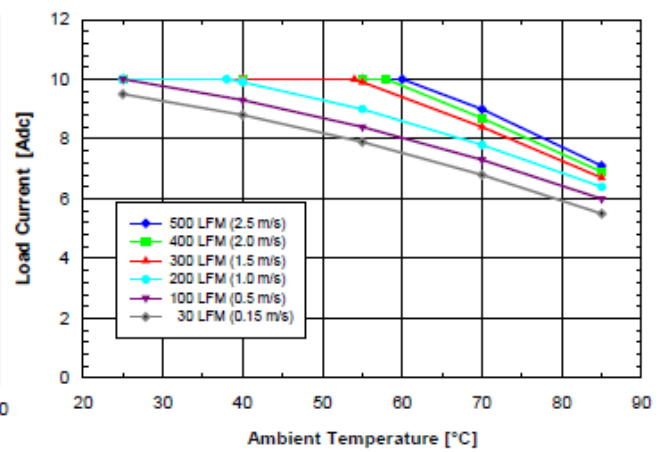

Figure 5.0V.4 Available load current vs. ambient air temperature and airflow rates for SQ48S10050 converter with D height pins mounted horizontally with  $V_{in} = 48V$ , air flowing from pin 3 to pin 1, and maximum FET temperature  $\leq 120^{\circ}C$ .

# SQ48 DC-DC Series



Fig. 5.0V.5: Efficiency vs. load current and input voltage for SQ48T/S10050 converter mounted vertically with air flowing from pin 3 to pin 1 at a rate of 300LFM (1.5 m/s) and  $T_a = 25^\circ\text{C}$ .



Fig. 5.0V.6: Efficiency vs. load current and ambient temperature for SQ48T/S10050 converter mounted vertically with  $V_{in} = 48\text{V}$  and air flowing from pin 3 to pin 1 at a rate of 200LFM (1.0 m/s).



Fig. 5.0V.7: Power dissipation vs. load current and input voltage for SQ48T/S10050 converter mounted vertically with air flowing from pin 3 to pin 1 at a rate of 300 LFM (1.5 m/s) and  $T_a = 25^\circ\text{C}$ .



Fig. 5.0V.8: Power dissipation vs. load current and ambient temperature for SQ48T/S10050 converter mounted vertically with  $V_{in} = 48\text{V}$  and air flowing from pin 3 to pin 1 at a rate of 200LFM (1.0m/s).



Fig. 5.0V.9: Turn-on transient at full rated load current (resistive) with no output capacitor at  $V_{in} = 48V$ , triggered via ON/OFF pin. Top trace: ON/OFF signal (5V/div.). Bottom trace: output voltage (2V/div.). Time scale: 2ms/div.

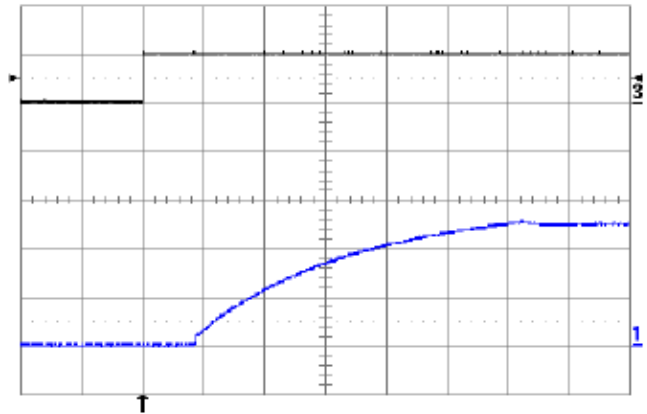

Fig. 5.0V.10: Turn-on transient at full rated load current (resistive) plus 10,000  $\mu F$  at  $V_{in} = 48V$ , triggered via ON/OFF pin. Top trace: ON/OFF signal (5V/div.). Bottom trace: output voltage (2V/div.). Time scale: 5ms/div.



Fig. 5.0V.11: Output voltage response to load current step-change (2.5A – 5A – 2.5A) at  $V_{in} = 48V$ . Top trace: output voltage (200mV/div.). Bottom trace: load current (2A/div.). Current slew rate: 0.1A/ $\mu s$ .  $C_o = 1\mu F$  ceramic. Time scale: 0.2 ms/div.



Fig. 5.0V.12: Output voltage response to load current step-change (2.5A – 5A – 2.5A) at  $V_{in} = 48V$ . Top trace: output voltage (200 mV/div.). Bottom trace: load current (2A/div.). Current slew rate: 5 A/ $\mu s$ .  $C_o = 450\mu F$  tantalum + 1 $\mu F$  ceramic. Time scale: 0.2 ms/div.



Fig. 5.0V.13: Output voltage ripple (20 mV/div.) at full rated load current into a resistive load with  $C_o = 10\mu\text{F}$  tantalum +  $1\mu\text{F}$  ceramic and  $V_{in} = 48\text{V}$ . Time scale:  $1\mu\text{s}/\text{div}$ .



Fig. 5.0V.14: Test Setup for measuring input reflected ripple currents,  $i_c$  and  $i_s$



Fig. 5.0V.15: Input reflected ripple current,  $i_c$  (100 mA/div.), measured at input terminals at full rated load current and  $V_{in} = 48\text{V}$ . Refer to Fig. 5.0V.14 for test setup. Time scale:  $1\mu\text{s}/\text{div}$ .



Fig. 5.0V.16: Input reflected ripple current,  $i_s$  (10 mA/div.), measured through  $10\mu\text{H}$  at the source at full rated full rated load current and  $V_{in} = 48\text{V}$ . Refer to Fig. 5.0V.14 for test setup. Time scale:  $1\mu\text{s}/\text{div}$ .



Fig. 5.0V.17: Output voltage vs. load current showing current limit point and converter shutdown point. Input voltage has almost no effect on current limit characteristic.



Fig. 5.0V.18: Load current (top trace, 10A/div., 20 ms/div.) into a  $10\text{m}\Omega$  short circuit during restart, at  $V_{in} = 48\text{V}$ . Bottom trace (10A/div., 1ms/div.) is an expansion of the on-time portion of the top trace.

## 5.5 SQ48T/S15033 (3.3 Volt Out)

Conditions: T<sub>A</sub> = 25 °C, Airflow = 300 LFM (1.5 m/s), Vin = 48 VDC, Vout = 3.3 VDC, unless otherwise specified.

PARAMETER	CONDITIONS/DESCRIPTION	MIN	TYP	MAX	UNITS
<i>Input Characteristics</i>					
Maximum Input Current	15 ADC, 3.3 VDC Out @ 36 VDC In			1.6	ADC
Input Stand-by Current	Vin = 48V, converter disabled		2.6		mADC
Input No Load Current (0 load on the output)	Vin = 48V, converter enabled		42		mADC
Input Reflected-Ripple Current	25MHz bandwidth		6		mA <sub>PK-PK</sub>
<i>Output Characteristics</i>					
Output Voltage Set Point (no load)		3.267	3.300	3.333	VDC
Output Regulation					
Over Line			±2	±5	mV
Over Load			±2	±5	mV
Output Voltage Range	Over line, load and temperature <sup>6</sup>	3.250		3.350	VDC
Output Ripple and Noise - 25 MHz bandwidth	Full load + 10 µF tantalum + 1 µF ceramic		30	50	mV <sub>PK-PK</sub>
External Load Capacitance	Plus full load (resistive)			15,000	µF
Output Current Range		0		15	ADC
Current Limit Inception	Non-latching	15.75	18	20	ADC
Peak Short-Circuit Current	Non-latching, Short =10 mΩ.		30	40	A
RMS Short-Circuit Current	Non-latching			5.3	Arms
<i>Dynamic Response</i>					
Load Change 25% of Iout Max, di/dt = 0.1 A/µs	Co = 1 µF ceramic		80		mV
di/dt = 5 A/µs	Co = 450 µF tantalum + 1 µF ceramic		140		mV
Settling Time to 1%			100		µs
<i>Efficiency</i>					
100% Load			89.5		%
50% Load			89.5		%

<sup>6</sup> -40 °C to 85 °C.



Figure 3.3V.1 Available load current vs. ambient air temperature and airflow rates for SQ48T15033 converter with D height pins mounted vertically with  $V_{in} = 48V$ , air flowing from pin 3 to pin 1, and maximum FET temperature  $\leq 120^{\circ}C$ .

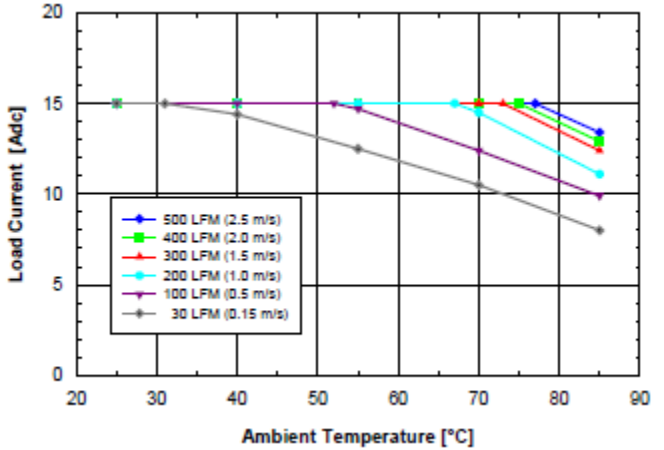

Figure 3.3V.2 Available load current vs. ambient air temperature and airflow rates for SQ48T15033 converter with D height pins mounted horizontally with  $V_{in} = 48V$ , air flowing from pin 3 to pin 1, and maximum FET temperature  $\leq 120^{\circ}C$ .



Figure 3.3V.3 Available load current vs. ambient air temperature and airflow rates for SQ48S15033 converter with D height pins mounted vertically with  $V_{in} = 48V$ , air flowing from pin 3 to pin 1, and maximum FET temperature  $\leq 120^{\circ}C$ .

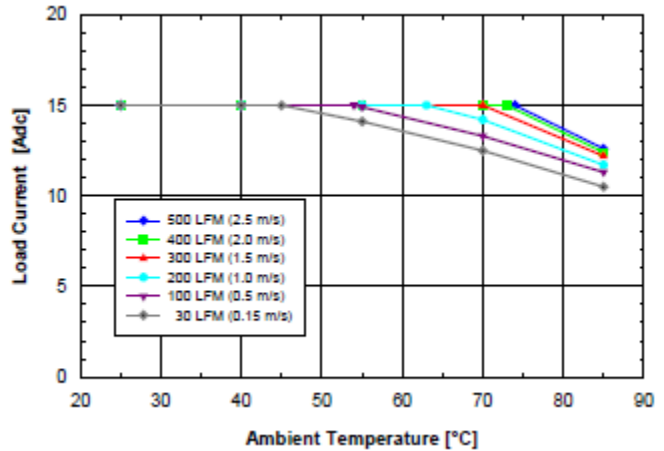

Figure 3.3V.4 Available load current vs. ambient air temperature and airflow rates for SQ48S15033 converter with D height pins mounted horizontally with  $V_{in} = 48V$ , air flowing from pin 3 to pin 1, and maximum FET temperature  $\leq 120^{\circ}C$ .



Fig. 3.3V.5: Efficiency vs. load current and input voltage for SQ48T/S15033 converter mounted vertically with air flowing from pin 3 to pin 1 at a rate of 300LFM (1.5 m/s) and  $T_a = 25^\circ\text{C}$ .



Fig. 3.3V.6: Efficiency vs. load current and ambient temperature for SQ48T/S15033 converter mounted vertically with  $V_{in} = 48\text{V}$  and air flowing from pin 3 to pin 1 at a rate of 200LFM (1.0 m/s).



Fig. 3.3V.7: Power dissipation vs. load current and input voltage for SQ48T/S15033 converter mounted vertically with air flowing from pin 3 to pin 1 at a rate of 300 LFM (1.5 m/s) and  $T_a = 25^\circ\text{C}$ .



Fig. 3.3V.8: Power dissipation vs. load current and ambient temperature for SQ48T/S15033 converter mounted vertically with  $V_{in} = 48\text{V}$  and air flowing from pin 3 to pin 1 at a rate of 200LFM (1.0m/s).



Fig. 3.3V.9: Turn-on transient at full rated load current (resistive) with no output capacitor at  $V_{in} = 48V$ , triggered via ON/OFF pin. Top trace: ON/OFF signal (5V/div.). Bottom trace: output voltage (2V/div.). Time scale: 2ms/div.



Fig. 3.3V.10: Turn-on transient at full rated load current (resistive) plus 10,000  $\mu F$  at  $V_{in} = 48V$ , triggered via ON/OFF pin. Top trace: ON/OFF signal (5V/div.). Bottom trace: output voltage (1V/div.). Time scale: 2ms/div.



Fig. 3.3V.11: Output voltage response to load current step-change (3.75 A - 7.5 A - 3.75 A) at  $V_{in} = 48V$ . Top trace: output voltage (100mV/div.). Bottom trace: load current (5A/div.). Current slew rate: 0.1A/ $\mu s$ .  $C_o = 1\mu F$  ceramic. Time scale: 0.2 ms/div.



Fig. 3.3V.12: Output voltage response to load current step-change (3.75 A - 7.5 A - 3.75 A) at  $V_{in} = 48V$ . Top trace: output voltage (100 mV/div.). Bottom trace: load current (5A/div.). Current slew rate: 5 A/ $\mu s$ .  $C_o = 450\mu F$  tantalum + 1 $\mu F$  ceramic. Time scale: 0.2 ms/div.



Fig. 3.3V.13: Output voltage ripple (20 mV/div.) at full rated load current into a resistive load with  $C_o = 10\mu\text{F}$  tantalum +  $1\mu\text{F}$  ceramic and  $V_{in} = 48\text{V}$ . Time scale:  $1\mu\text{s}/\text{div}$ .

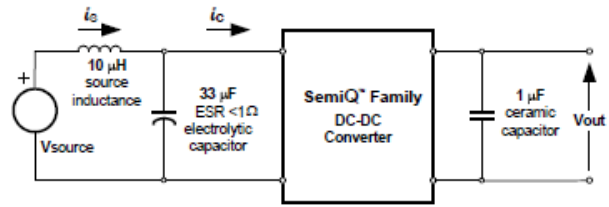

Fig. 3.3V.14: Test Setup for measuring input reflected ripple currents,  $i_c$  and  $i_s$



Fig. 3.3V.15: Input reflected ripple current,  $i_c$  (100 mA/div.), measured at input terminals at full rated load current and  $V_{in} = 48\text{V}$ . Refer to Fig. 3.3V.14 for test setup. Time scale:  $1\mu\text{s}/\text{div}$ .



Fig. 3.3V.16: Input reflected ripple current,  $i_s$  (10 mA/div.), measured through  $10\mu\text{H}$  at the source at full rated full rated load current and  $V_{in} = 48\text{V}$ . Refer to Fig. 3.3V.14 for test setup. Time scale:  $1\mu\text{s}/\text{div}$ .



Fig. 3.3V.17: Output voltage vs. load current showing current limit point and converter shutdown point. Input voltage has almost no effect on current limit characteristic.



Fig. 3.3V.18: Load current (top trace, 10A/div., 20 ms/div.) into a  $10\text{m}\Omega$  short circuit during restart, at  $V_{in} = 48\text{V}$ . Bottom trace (20A/div., 1ms/div.) is an expansion of the on-time portion of the top trace.

### 5.6 SQ48T/S15025 (2.5 Volt Out)

Conditions:  $T_A = 25\text{ }^\circ\text{C}$ , Airflow = 300 LFM (1.5 m/s),  $V_{in} = 48\text{ VDC}$ ,  $V_{out} = 2.5\text{ VDC}$ , unless otherwise specified.

PARAMETER	CONDITIONS/DESCRIPTION	MIN	TYP	MAX	UNITS
<b>Input Characteristics</b>					
Maximum Input Current	15 ADC, 2.5 VDC Out @ 36 VDC In			1.2	ADC
Input Stand-by Current	$V_{in} = 48\text{V}$ , converter disabled		2.6		mADC
Input No Load Current (0 load on the output)	$V_{in} = 48\text{V}$ , converter enabled		34		mADC
Input Reflected-Ripple Current	25MHz bandwidth		6		$\text{mA}_{\text{PK-PK}}$
<b>Output Characteristics</b>					
Output Voltage Set Point (no load)		2.475	2.500	2.525	VDC
Output Regulation					
Over Line			$\pm 2$	$\pm 5$	mV
Over Load			$\pm 2$	$\pm 5$	mV
Output Voltage Range	Over line, load and temperature <sup>7</sup>	2.462		2.538	VDC
Output Ripple and Noise - 25 MHz bandwidth	Full load + 10 $\mu\text{F}$ tantalum + 1 $\mu\text{F}$ ceramic		30	50	$\text{mV}_{\text{PK-PK}}$
External Load Capacitance	Plus full load (resistive)			15,000	$\mu\text{F}$
Output Current Range		0		15	ADC
Current Limit Inception	Non-latching	15.75	18	20	ADC
Peak Short-Circuit Current	Non-latching, Short = 10 m $\Omega$ .		30	40	A
RMS Short-Circuit Current	Non-latching			5.3	Arms
<b>Dynamic Response</b>					
Load Change 25% of $I_{out}$ Max, $di/dt = 0.1\text{ A}/\mu\text{s}$	$C_o = 1\text{ }\mu\text{F}$ ceramic		120		mV
$di/dt = 5\text{ A}/\mu\text{s}$	$C_o = 450\text{ }\mu\text{F}$ tantalum + 1 $\mu\text{F}$ ceramic		120		mV
Settling Time to 1%			100		$\mu\text{s}$
<b>Efficiency</b>					
100% Load			87.0		%
50% Load			87.5		%

<sup>7</sup> -40  $^\circ\text{C}$  to 85  $^\circ\text{C}$ .



Figure 2.5V.1 Available load current vs. ambient air temperature and airflow rates for SQ48T15025 converter with D height pins mounted vertically with  $V_{in} = 48V$ , air flowing from pin 3 to pin 1, and maximum FET temperature  $\leq 120^{\circ}C$ .



Figure 2.5V.2 Available load current vs. ambient air temperature and airflow rates for SQ48T15025 converter with D height pins mounted horizontally with  $V_{in} = 48V$ , air flowing from pin 3 to pin 1, and maximum FET temperature  $\leq 120^{\circ}C$ .



Figure 2.5V.3 Available load current vs. ambient air temperature and airflow rates for SQ48S15025 converter with D height pins mounted vertically with  $V_{in} = 48V$ , air flowing from pin 3 to pin 1, and maximum FET temperature  $\leq 120^{\circ}C$ .



Figure 2.5V.4 Available load current vs. ambient air temperature and airflow rates for SQ48S15025 converter with D height pins mounted horizontally with  $V_{in} = 48V$ , air flowing from pin 3 to pin 1, and maximum FET temperature  $\leq 120^{\circ}C$ .



Fig. 2.5V.5: Efficiency vs. load current and input voltage for SQ48T/S15025 converter mounted vertically with air flowing from pin 3 to pin 1 at a rate of 300LFM (1.5 m/s) and  $T_a = 25^\circ\text{C}$ .



Fig. 2.5V.6: Efficiency vs. load current and ambient temperature for SQ48T/S15025 converter mounted vertically with  $V_{in} = 48\text{V}$  and air flowing from pin 3 to pin 1 at a rate of 200LFM (1.0 m/s).



Fig. 2.5V.7: Power dissipation vs. load current and input voltage for SQ48T/S15025 converter mounted vertically with air flowing from pin 3 to pin 1 at a rate of 300 LFM (1.5 m/s) and  $T_a = 25^\circ\text{C}$ .



Fig. 2.5V.8: Power dissipation vs. load current and ambient temperature for SQ48T/S15025 converter mounted vertically with  $V_{in} = 48\text{V}$  and air flowing from pin 3 to pin 1 at a rate of 200LFM (1.0m/s).



Fig. 2.5V.9: Turn-on transient at full rated load current (resistive) with no output capacitor at  $V_{in} = 48V$ , triggered via ON/OFF pin. Top trace: ON/OFF signal (5V/div.). Bottom trace: output voltage (1V/div.). Time scale: 2ms/div.



Fig. 2.5V.10: Turn-on transient at full rated load current (resistive) plus 10,000  $\mu F$  at  $V_{in} = 48V$ , triggered via ON/OFF pin. Top trace: ON/OFF signal (5V/div.). Bottom trace: output voltage (1V/div.). Time scale: 2ms/div.



Fig. 2.5V.11: Output voltage response to load current step-change (3.75 A – 7.5 A – 3.75 A) at  $V_{in} = 48V$ . Top trace: output voltage (100mV/div.). Bottom trace: load current (5A/div.). Current slew rate: 0.1A/ $\mu s$ .  $C_o = 1\mu F$  ceramic. Time scale: 0.2 ms/div.



Fig. 2.5V.12: Output voltage response to load current step-change (3.75 A – 7.5 A – 3.75 A) at  $V_{in} = 48V$ . Top trace: output voltage (100 mV/div.). Bottom trace: load current (5A/div.). Current slew rate: 5 A/ $\mu s$ .  $C_o = 450\mu F$  tantalum + 1 $\mu F$  ceramic. Time scale: 0.2 ms/div.

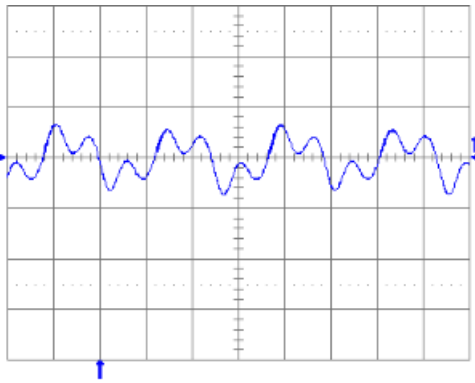

Fig. 2.5V.13: Output voltage ripple (20 mV/div.) at full rated load current into a resistive load with  $C_o = 10\mu\text{F}$  tantalum +  $1\mu\text{F}$  ceramic and  $V_{in} = 48\text{V}$ . Time scale:  $1\mu\text{s}/\text{div}$ .



Fig. 2.5V.14: Test Setup for measuring input reflected ripple currents,  $i_c$  and  $i_s$

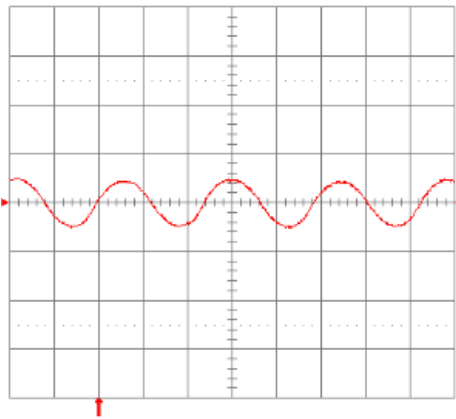

Fig. 2.5V.15: Input reflected ripple current,  $i_c$  (100 mA/div.), measured at input terminals at full rated load current and  $V_{in} = 48\text{V}$ . Refer to Fig. 2.5V.14 for test setup. Time scale:  $1\mu\text{s}/\text{div}$ .

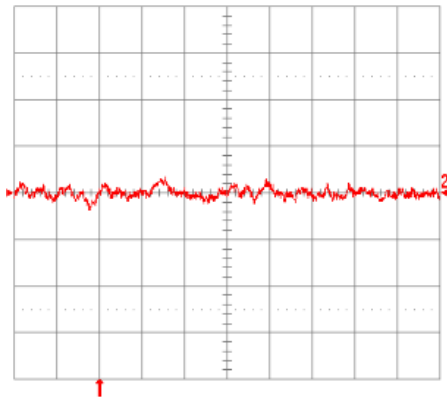

Fig. 2.5V.16: Input reflected ripple current,  $i_s$  (10 mA/div.), measured through  $10\mu\text{H}$  at the source at full rated full rated load current and  $V_{in} = 48\text{V}$ . Refer to Fig. 2.5V.14 for test setup. Time scale:  $1\mu\text{s}/\text{div}$ .



Fig. 2.5V.17: Output voltage vs. load current showing current limit point and converter shutdown point. Input voltage has almost no effect on current limit characteristic.

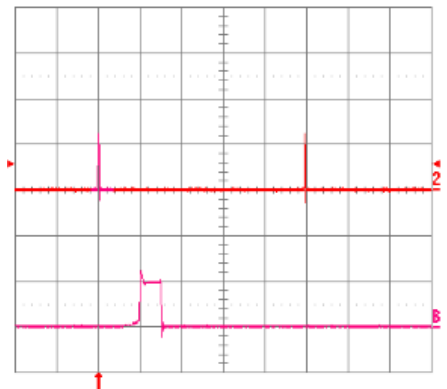

Fig. 2.5V.18: Load current (top trace,  $20\text{A}/\text{div}$ .,  $20\text{ms}/\text{div}$ .) into a  $10\text{m}\Omega$  short circuit during restart, at  $V_{in} = 48\text{V}$ . Bottom trace ( $20\text{A}/\text{div}$ .,  $1\text{ms}/\text{div}$ .) is an expansion of the on-time portion of the top trace.

## 5.7 SQ48T/S15020 (2.0 Volt Out)

Conditions: T<sub>A</sub> = 25 °C, Airflow = 300 LFM (1.5 m/s), Vin = 48 VDC, Vout = 2.0 VDC, unless otherwise specified.

PARAMETER	CONDITIONS/DESCRIPTION	MIN	TYP	MAX	UNITS
<b>Input Characteristics</b>					
Maximum Input Current	15 ADC, 2.0 VDC Out @ 36 VDC In			1.0	ADC
Input Stand-by Current	Vin = 48V, converter disabled		3		mADC
Input No Load Current (0 load on the output)	Vin = 48V, converter enabled		31		mADC
Input Reflected-Ripple Current	25MHz bandwidth		6		mA <sub>PK-PK</sub>
<b>Output Characteristics</b>					
Output Voltage Set Point (no load)		1.98	2.000	2.02	VDC
Output Regulation					
Over Line			±2	±5	mV
Over Load			±2	±5	mV
Output Voltage Range	Over line, load and temperature <sup>8</sup>	1.970		2.030	VDC
Output Ripple and Noise - 25 MHz bandwidth	Full load + 10 µF tantalum + 1 µF ceramic		30	50	mV <sub>PK-PK</sub>
External Load Capacitance	Plus full load (resistive)			15,000	µF
Output Current Range		0		15	ADC
Current Limit Inception	Non-latching	15.75	18	20	ADC
Peak Short-Circuit Current	Non-latching, Short =10 mΩ.		30	40	A
RMS Short-Circuit Current	Non-latching			5.3	Arms
<b>Dynamic Response</b>					
Load Change 25% of Iout Max, di/dt = 0.1 A/µs	Co = 1 µF ceramic		80		mV
di/dt = 5 A/µs	Co = 450 µF tantalum + 1 µF ceramic		60		mV
Settling Time to 1%			60		µs
<b>Efficiency</b>					
100% Load			86.5		%
50% Load			87.0		%

<sup>8</sup> -40 °C to 85 °C.



Asia-Pacific  
+86 755 298 85888

Europe, Middle East  
+353 61 225 977

North America  
+1 408 785 5200



Figure 2.0V.1 Available load current vs. ambient air temperature and airflow rates for SQ48T15020 converter with D height pins mounted vertically with  $V_{in} = 48V$ , air flowing from pin 3 to pin 1, and maximum FET temperature  $\leq 120^{\circ}C$ .



Figure 2.0V.2 Available load current vs. ambient air temperature and airflow rates for SQ48T15020 converter with D height pins mounted horizontally with  $V_{in} = 48V$ , air flowing from pin 3 to pin 1, and maximum FET temperature  $\leq 120^{\circ}C$ .



Figure 2.0V.3 Available load current vs. ambient air temperature and airflow rates for SQ48S15020 converter with D height pins mounted vertically with  $V_{in} = 48V$ , air flowing from pin 3 to pin 1, and maximum FET temperature  $\leq 120^{\circ}C$ .



Figure 2.0V.4 Available load current vs. ambient air temperature and airflow rates for SQ48S15020 converter with D height pins mounted horizontally with  $V_{in} = 48V$ , air flowing from pin 3 to pin 1, and maximum FET temperature  $\leq 120^{\circ}C$ .



Fig. 2.0V.5: Efficiency vs. load current and input voltage for SQ48T/S15020 converter mounted vertically with air flowing from pin 3 to pin 1 at a rate of 300LFM (1.5 m/s) and  $T_a = 25^\circ\text{C}$ .



Fig. 2.0V.6: Efficiency vs. load current and ambient temperature for SQ48T/S15020 converter mounted vertically with  $V_{in} = 48\text{V}$  and air flowing from pin 3 to pin 1 at a rate of 200LFM (1.0 m/s).



Fig. 2.0V.7: Power dissipation vs. load current and input voltage for SQ48T/S15020 converter mounted vertically with air flowing from pin 3 to pin 1 at a rate of 300 LFM (1.5 m/s) and  $T_a = 25^\circ\text{C}$ .



Fig. 2.0V.8: Power dissipation vs. load current and ambient temperature for SQ48T/S15020 converter mounted vertically with  $V_{in} = 48\text{V}$  and air flowing from pin 3 to pin 1 at a rate of 200LFM (1.0m/s).



Fig. 2.0V.9: Turn-on transient at full rated load current (resistive) with no output capacitor at  $V_{in} = 48V$ , triggered via ON/OFF pin. Top trace: ON/OFF signal (5V/div.). Bottom trace: output voltage (1V/div.). Time scale: 2ms/div.



Fig. 2.0V.10: Turn-on transient at full rated load current (resistive) plus 10,000  $\mu F$  at  $V_{in} = 48V$ , triggered via ON/OFF pin. Top trace: ON/OFF signal (5V/div.). Bottom trace: output voltage (1V/div.). Time scale: 2ms/div.



Fig. 2.0V.11: Output voltage response to load current step-change (3.75 A – 7.5 A – 3.75 A) at  $V_{in} = 48V$ . Top trace: output voltage (100mV/div.). Bottom trace: load current (5A/div.). Current slew rate: 0.1A/ $\mu s$ .  $C_o = 1\mu F$  ceramic. Time scale: 0.2 ms/div.



Fig. 2.0V.12: Output voltage response to load current step-change (3.75 A – 7.5 A – 3.75 A) at  $V_{in} = 48V$ . Top trace: output voltage (100 mV/div.). Bottom trace: load current (5A/div.). Current slew rate: 5 A/ $\mu s$ .  $C_o = 450\mu F$  tantalum + 1 $\mu F$  ceramic. Time scale: 0.2 ms/div.



Fig. 2.0V.13: Output voltage ripple (20 mV/div.) at full rated load current into a resistive load with  $C_o = 10\mu\text{F}$  tantalum +  $1\mu\text{F}$  ceramic and  $V_{in} = 48\text{V}$ . Time scale:  $1\mu\text{s}/\text{div}$ .



Fig. 2.0V.14: Test Setup for measuring input reflected ripple currents,  $i_c$  and  $i_s$



Fig. 2.0V.15: Input reflected ripple current,  $i_c$  (100 mA/div.), measured at input terminals at full rated load current and  $V_{in} = 48\text{V}$ . Refer to Fig. 2.0V.14 for test setup. Time scale:  $1\mu\text{s}/\text{div}$ .



Fig. 2.0V.16: Input reflected ripple current,  $i_s$  (10 mA/div.), measured through  $10\mu\text{H}$  at the source at full rated full rated load current and  $V_{in} = 48\text{V}$ . Refer to Fig. 2.0V.14 for test setup. Time scale:  $1\mu\text{s}/\text{div}$ .



Fig. 2.0V.17: Output voltage vs. load current showing current limit point and converter shutdown point. Input voltage has almost no effect on current limit characteristic.



Fig. 2.0V.18: Load current (top trace,  $20\text{A}/\text{div}$ .,  $20\text{ms}/\text{div}$ .) into a  $10\text{m}\Omega$  short circuit during restart, at  $V_{in} = 48\text{V}$ . Bottom trace ( $20\text{A}/\text{div}$ .,  $1\text{ms}/\text{div}$ .) is an expansion of the on-time portion of the top trace.

### 5.8 SQ48T/S15018 (1.8 Volt Out)

Conditions:  $T_A = 25\text{ }^\circ\text{C}$ , Airflow = 300 LFM (1.5 m/s),  $V_{in} = 48\text{ VDC}$ ,  $V_{out} = 1.8\text{ VDC}$ , unless otherwise specified.

PARAMETER	CONDITIONS/DESCRIPTION	MIN	TYP	MAX	UNITS
<b>Input Characteristics</b>					
Maximum Input Current	15 ADC, 1.8 VDC Out @ 36 VDC In			0.9	ADC
Input Stand-by Current	$V_{in} = 48\text{V}$ , converter disabled		2.6		mADC
Input No Load Current (0 load on the output)	$V_{in} = 48\text{V}$ , converter enabled		29		mADC
Input Reflected-Ripple Current	25MHz bandwidth		6		$\text{mA}_{\text{PK-PK}}$
<b>Output Characteristics</b>					
Output Voltage Set Point (no load)		1.782	1.800	1.818	VDC
Output Regulation					
Over Line			$\pm 2$	$\pm 4$	mV
Over Load			$\pm 2$	$\pm 5$	mV
Output Voltage Range	Over line, load and temperature <sup>9</sup>	1.773		1.827	VDC
Output Ripple and Noise - 25 MHz bandwidth	Full load + 10 $\mu\text{F}$ tantalum + 1 $\mu\text{F}$ ceramic		30	50	$\text{mV}_{\text{PK-PK}}$
External Load Capacitance	Plus full load (resistive)			15,000	$\mu\text{F}$
Output Current Range		0		15	ADC
Current Limit Inception	Non-latching	15.75	18	20	ADC
Peak Short-Circuit Current	Non-latching, Short = 10 m $\Omega$ .		30	40	A
RMS Short-Circuit Current	Non-latching			5.3	Arms
<b>Dynamic Response</b>					
Load Change 25% of $I_{out}$ Max, $di/dt = 0.1\text{ A}/\mu\text{s}$	$C_o = 1\text{ }\mu\text{F}$ ceramic		80		mV
$di/dt = 5\text{ A}/\mu\text{s}$	$C_o = 450\text{ }\mu\text{F}$ tantalum + 1 $\mu\text{F}$ ceramic		100		mV
Settling Time to 1%			100		$\mu\text{s}$
<b>Efficiency</b>					
100% Load			85.5		%
50% Load			86.0		%

<sup>9</sup> -40  $^\circ\text{C}$  to 85  $^\circ\text{C}$ .



Figure 1.8V.1 Available load current vs. ambient air temperature and airflow rates for SQ48T15018 converter with D height pins mounted vertically with  $V_{in} = 48V$ , air flowing from pin 3 to pin 1, and maximum FET temperature  $\leq 120^{\circ}C$ .



Figure 1.8V.2 Available load current vs. ambient air temperature and airflow rates for SQ48T15018 converter with D height pins mounted horizontally with  $V_{in} = 48V$ , air flowing from pin 3 to pin 1, and maximum FET temperature  $\leq 120^{\circ}C$ .

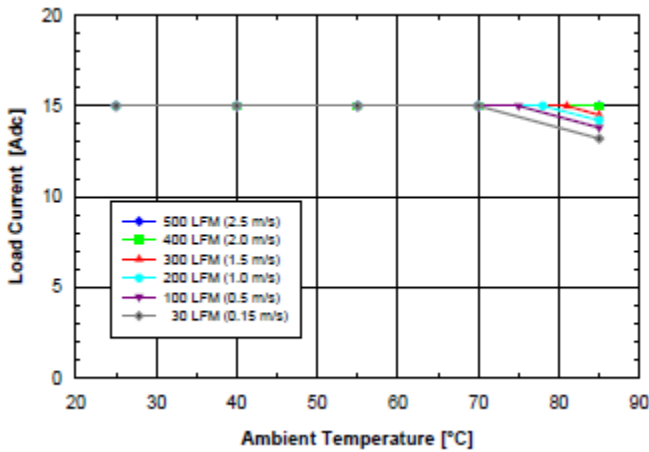

Figure 1.8V.3 Available load current vs. ambient air temperature and airflow rates for SQ48S15018 converter with D height pins mounted vertically with  $V_{in} = 48V$ , air flowing from pin 3 to pin 1, and maximum FET temperature  $\leq 120^{\circ}C$ .

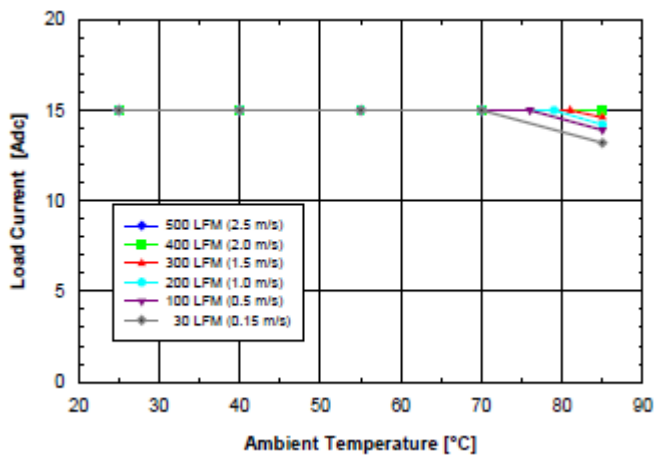

Figure 1.8V.4 Available load current vs. ambient air temperature and airflow rates for SQ48S15018 converter with D height pins mounted horizontally with  $V_{in} = 48V$ , air flowing from pin 3 to pin 1, and maximum FET temperature  $\leq 120^{\circ}C$ .



Fig. 1.8V.5: Efficiency vs. load current and input voltage for SQ48T/S15018 converter mounted vertically with air flowing from pin 3 to pin 1 at a rate of 300LFM (1.5 m/s) and  $T_a = 25^\circ\text{C}$ .



Fig. 1.8V.6: Efficiency vs. load current and ambient temperature for SQ48T/S15018 converter mounted vertically with  $V_{in} = 48\text{V}$  and air flowing from pin 3 to pin 1 at a rate of 200LFM (1.0 m/s).



Fig. 1.8V.7: Power dissipation vs. load current and input voltage for SQ48T/S15018 converter mounted vertically with air flowing from pin 3 to pin 1 at a rate of 300 LFM (1.5 m/s) and  $T_a = 25^\circ\text{C}$ .



Fig. 1.8V.8: Power dissipation vs. load current and ambient temperature for SQ48T/S15018 converter mounted vertically with  $V_{in} = 48\text{V}$  and air flowing from pin 3 to pin 1 at a rate of 200LFM (1.0m/s).



Fig. 1.8V.9: Turn-on transient at full rated load current (resistive) with no output capacitor at  $V_{in} = 48V$ , triggered via ON/OFF pin. Top trace: ON/OFF signal (5V/div.). Bottom trace: output voltage (1V/div.). Time scale: 2ms/div.



Fig. 1.8V.10: Turn-on transient at full rated load current (resistive) plus 10,000  $\mu F$  at  $V_{in} = 48V$ , triggered via ON/OFF pin. Top trace: ON/OFF signal (5V/div.). Bottom trace: output voltage (1V/div.). Time scale: 2ms/div.



Fig. 1.8V.11: Output voltage response to load current step-change (3.75 A – 7.5 A – 3.75 A) at  $V_{in} = 48V$ . Top trace: output voltage (100mV/div.). Bottom trace: load current (5A/div.). Current slew rate: 0.1A/ $\mu s$ .  $C_o = 1\mu F$  ceramic. Time scale: 0.2 ms/div.



Fig. 1.8V.12: Output voltage response to load current step-change (3.75 A – 7.5 A – 3.75 A) at  $V_{in} = 48V$ . Top trace: output voltage (100 mV/div.). Bottom trace: load current (5A/div.). Current slew rate: 5 A/ $\mu s$ .  $C_o = 450\mu F$  tantalum + 1 $\mu F$  ceramic. Time scale: 0.2 ms/div.



Fig. 1.8V.13: Output voltage ripple (20 mV/div.) at full rated load current into a resistive load with  $C_o = 10\mu\text{F}$  tantalum +  $1\mu\text{F}$  ceramic and  $V_{in} = 48\text{V}$ . Time scale:  $1\mu\text{s}/\text{div}$ .

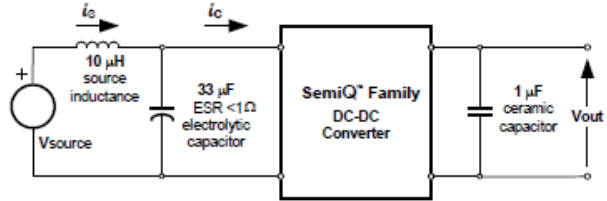

Fig. 1.8V.14: Test Setup for measuring input reflected ripple currents,  $i_c$  and  $i_s$



Fig. 1.8V.15: Input reflected ripple current,  $i_c$  (100 mA/div.), measured at input terminals at full rated load current and  $V_{in} = 48\text{V}$ . Refer to Fig. 1.8V.14 for test setup. Time scale:  $1\mu\text{s}/\text{div}$ .



Fig. 1.8V.16: Input reflected ripple current,  $i_s$  (10 mA/div.), measured through  $10\mu\text{H}$  at the source at full rated full rated load current and  $V_{in} = 48\text{V}$ . Refer to Fig. 1.8V.14 for test setup. Time scale:  $1\mu\text{s}/\text{div}$ .



Fig. 1.8V.17: Output voltage vs. load current showing current limit point and converter shutdown point. Input voltage has almost no effect on current limit characteristic.



Fig. 1.8V.18: Load current (top trace, 20A/div., 20 ms/div.) into a  $10\text{m}\Omega$  short circuit during restart, at  $V_{in} = 48\text{V}$ . Bottom trace (20A/div., 1ms/div.) is an expansion of the on-time portion of the top trace.

## 5.9 SQ48T/S15015 (1.5 Volt Out)

Conditions:  $T_A = 25\text{ }^\circ\text{C}$ , Airflow = 300 LFM (1.5 m/s),  $V_{in} = 48\text{ VDC}$ ,  $V_{out} = 1.5\text{ VDC}$ , unless otherwise specified.

PARAMETER	CONDITIONS/DESCRIPTION	MIN	TYP	MAX	UNITS
<b>Input Characteristics</b>					
Maximum Input Current	15 ADC, 1.5 VDC Out @ 36 VDC In			0.75	ADC
Input Stand-by Current	$V_{in} = 48\text{V}$ , converter disabled		2.6		mADC
Input No Load Current (0 load on the output)	$V_{in} = 48\text{V}$ , converter enabled		25		mADC
Input Reflected-Ripple Current	25MHz bandwidth		6		$\text{mA}_{\text{PK-PK}}$
<b>Output Characteristics</b>					
Output Voltage Set Point (no load)		1.485	1.500	1.515	VDC
Output Regulation					
Over Line			$\pm 2$	$\pm 4$	mV
Over Load			$\pm 2$	$\pm 4$	mV
Output Voltage Range	Over line, load and temperature <sup>10</sup>	1.477		1.523	VDC
Output Ripple and Noise - 25 MHz bandwidth	Full load + 10 $\mu\text{F}$ tantalum + 1 $\mu\text{F}$ ceramic		30	50	$\text{mV}_{\text{PK-PK}}$
External Load Capacitance	Plus full load (resistive)			15,000	$\mu\text{F}$
Output Current Range		0		15	ADC
Current Limit Inception	Non-latching	15.75	18	20	ADC
Peak Short-Circuit Current	Non-latching, Short = 10 m $\Omega$ .		30	40	A
RMS Short-Circuit Current	Non-latching			5.3	Arms
<b>Dynamic Response</b>					
Load Change 25% of $I_{out}$ Max, $di/dt = 0.1\text{ A}/\mu\text{s}$	$C_o = 1\text{ }\mu\text{F}$ ceramic		80		mV
$di/dt = 5\text{ A}/\mu\text{s}$	$C_o = 450\text{ }\mu\text{F}$ tantalum + 1 $\mu\text{F}$ ceramic		120		mV
Settling Time to 1%			100		$\mu\text{s}$
<b>Efficiency</b>					
100% Load			84.5		%
50% Load			85.0		%

<sup>10</sup> -40  $^\circ\text{C}$  to 85  $^\circ\text{C}$ .



Figure 1.5V.1 Available load current vs. ambient air temperature and airflow rates for SQ48T15015 converter with D height pins mounted vertically with  $V_{in} = 48V$ , air flowing from pin 3 to pin 1, and maximum FET temperature  $\leq 120^{\circ}C$ .



Figure 1.5V.2 Available load current vs. ambient air temperature and airflow rates for SQ48T15015 converter with D height pins mounted horizontally with  $V_{in} = 48V$ , air flowing from pin 3 to pin 1, and maximum FET temperature  $\leq 120^{\circ}C$ .



Figure 1.5V.3 Available load current vs. ambient air temperature and airflow rates for SQ48S15015 converter with D height pins mounted vertically with  $V_{in} = 48V$ , air flowing from pin 3 to pin 1, and maximum FET temperature  $\leq 120^{\circ}C$ .



Figure 1.5V.4 Available load current vs. ambient air temperature and airflow rates for SQ48S15015 converter with D height pins mounted horizontally with  $V_{in} = 48V$ , air flowing from pin 3 to pin 1, and maximum FET temperature  $\leq 120^{\circ}C$ .



Fig. 1.5V.5: Efficiency vs. load current and input voltage for SQ48T/S15015 converter mounted vertically with air flowing from pin 3 to pin 1 at a rate of 300LFM (1.5 m/s) and  $T_a = 25^\circ\text{C}$ .



Fig. 1.5V.6: Efficiency vs. load current and ambient temperature for SQ48T/S15015 converter mounted vertically with  $V_{in} = 48\text{V}$  and air flowing from pin 3 to pin 1 at a rate of 200LFM (1.0 m/s).



Fig. 1.5V.7: Power dissipation vs. load current and input voltage for SQ48T/S15015 converter mounted vertically with air flowing from pin 3 to pin 1 at a rate of 300 LFM (1.5 m/s) and  $T_a = 25^\circ\text{C}$ .



Fig. 1.5V.8: Power dissipation vs. load current and ambient temperature for SQ48T/S15015 converter mounted vertically with  $V_{in} = 48\text{V}$  and air flowing from pin 3 to pin 1 at a rate of 200LFM (1.0m/s).



Fig. 1.5V.9: Turn-on transient at full rated load current (resistive) with no output capacitor at  $V_{in} = 48V$ , triggered via ON/OFF pin. Top trace: ON/OFF signal (5V/div.). Bottom trace: output voltage (0.5V/div.). Time scale: 2ms/div.



Fig. 1.5V.10: Turn-on transient at full rated load current (resistive) plus 10,000  $\mu F$  at  $V_{in} = 48V$ , triggered via ON/OFF pin. Top trace: ON/OFF signal (5V/div.). Bottom trace: output voltage (0.5V/div.). Time scale: 2ms/div.



Fig. 1.5V.11: Output voltage response to load current step-change (3.75 A – 7.5 A – 3.75 A) at  $V_{in} = 48V$ . Top trace: output voltage (100mV/div.). Bottom trace: load current (5A/div.). Current slew rate: 0.1A/ $\mu s$ .  $C_o = 1\mu F$  ceramic. Time scale: 0.2 ms/div.



Fig. 1.5V.12: Output voltage response to load current step-change (3.75 A – 7.5 A – 3.75 A) at  $V_{in} = 48V$ . Top trace: output voltage (100 mV/div.). Bottom trace: load current (5A/div.). Current slew rate: 5 A/ $\mu s$ .  $C_o = 450\mu F$  tantalum +  $1\mu F$  ceramic. Time scale: 0.2 ms/div.



Fig. 1.5V.13: Output voltage ripple (20 mV/div.) at full rated load current into a resistive load with  $C_o = 10\mu\text{F}$  tantalum +  $1\mu\text{F}$  ceramic and  $V_{in} = 48\text{V}$ . Time scale:  $1\mu\text{s}/\text{div}$ .



Fig. 1.5V.14: Test Setup for measuring input reflected ripple currents,  $i_c$  and  $i_s$



Fig. 1.5V.15: Input reflected ripple current,  $i_c$  (100 mA/div.), measured at input terminals at full rated load current and  $V_{in} = 48\text{V}$ . Refer to Fig. 1.5V.14 for test setup. Time scale:  $1\mu\text{s}/\text{div}$ .



Fig. 1.5V.16: Input reflected ripple current,  $i_s$  (10 mA/div.), measured through  $10\mu\text{H}$  at the source at full rated full rated load current and  $V_{in} = 48\text{V}$ . Refer to Fig. 1.5V.14 for test setup. Time scale:  $1\mu\text{s}/\text{div}$ .



Fig. 1.5V.17: Output voltage vs. load current showing current limit point and converter shutdown point. Input voltage has almost no effect on current limit characteristic.



Fig. 1.5V.18: Load current (top trace,  $20\text{A}/\text{div}$ .,  $20\text{ms}/\text{div}$ .) into a  $10\text{m}\Omega$  short circuit during restart, at  $V_{in} = 48\text{V}$ . Bottom trace ( $20\text{A}/\text{div}$ .,  $1\text{ms}/\text{div}$ .) is an expansion of the on-time portion of the top trace.

### 5.10 SQ48T/S15015 (1.2 Volt Out)

Conditions:  $T_A = 25\text{ }^\circ\text{C}$ , Airflow = 300 LFM (1.5 m/s),  $V_{in} = 48\text{ VDC}$ ,  $V_{out} = 1.2\text{ VDC}$ , unless otherwise specified.

PARAMETER	CONDITIONS/DESCRIPTION	MIN	TYP	MAX	UNITS
<b>Input Characteristics</b>					
Maximum Input Current	15 ADC, 1.2 VDC Out @ 36 VDC In			0.62	ADC
Input Stand-by Current	$V_{in} = 48\text{V}$ , converter disabled		2.6		mADC
Input No Load Current (0 load on the output)	$V_{in} = 48\text{V}$ , converter enabled		22		mADC
Input Reflected-Ripple Current	25MHz bandwidth		6		$\text{mA}_{\text{PK-PK}}$
<b>Output Characteristics</b>					
Output Voltage Set Point (no load)		1.188	1.200	1.212	VDC
Output Regulation					
Over Line			$\pm 1$	$\pm 3$	mV
Over Load			$\pm 1$	$\pm 3$	mV
Output Voltage Range	Over line, load and temperature <sup>11</sup>	1.182		1.218	VDC
Output Ripple and Noise - 25 MHz bandwidth	Full load + 10 $\mu\text{F}$ tantalum + 1 $\mu\text{F}$ ceramic		30	50	$\text{mV}_{\text{PK-PK}}$
External Load Capacitance	Plus full load (resistive)			15,000	$\mu\text{F}$
Output Current Range		0		15	ADC
Current Limit Inception	Non-latching	15.75	18	20	ADC
Peak Short-Circuit Current	Non-latching, Short = 10 m $\Omega$ .		30	40	A
RMS Short-Circuit Current	Non-latching			5.3	Arms
<b>Dynamic Response</b>					
Load Change 25% of $I_{out}$ Max, $di/dt = 0.1\text{ A}/\mu\text{s}$	$C_o = 1\text{ }\mu\text{F}$ ceramic		90		mV
$di/dt = 5\text{ A}/\mu\text{s}$	$C_o = 450\text{ }\mu\text{F}$ tantalum + 1 $\mu\text{F}$ ceramic		120		mV
Settling Time to 1%			100		$\mu\text{s}$
<b>Efficiency</b>					
100% Load			82.0		%
50% Load			83.0		%

<sup>11</sup> -40  $^\circ\text{C}$  to 85  $^\circ\text{C}$ .



Figure 1.2V.1 Available load current vs. ambient air temperature and airflow rates for SQ48T15012 converter with D height pins mounted vertically with  $V_{in} = 48V$ , air flowing from pin 3 to pin 1, and maximum FET temperature  $\leq 120^{\circ}C$ .



Figure 1.2V.2 Available load current vs. ambient air temperature and airflow rates for SQ48T15012 converter with D height pins mounted horizontally with  $V_{in} = 48V$ , air flowing from pin 3 to pin 1, and maximum FET temperature  $\leq 120^{\circ}C$ .



Figure 1.2V.3 Available load current vs. ambient air temperature and airflow rates for SQ48S15012 converter with D height pins mounted vertically with  $V_{in} = 48V$ , air flowing from pin 3 to pin 1, and maximum FET temperature  $\leq 120^{\circ}C$ .



Figure 1.2V.4 Available load current vs. ambient air temperature and airflow rates for SQ48S15012 converter with D height pins mounted horizontally with  $V_{in} = 48V$ , air flowing from pin 3 to pin 1, and maximum FET temperature  $\leq 120^{\circ}C$ .



Fig. 1.2V.5: Efficiency vs. load current and input voltage for SQ48T/S15012 converter mounted vertically with air flowing from pin 3 to pin 1 at a rate of 300LFM (1.5 m/s) and Ta = 25°C.



Fig. 1.2V.6: Efficiency vs. load current and ambient temperature for SQ48T/S15012 converter mounted vertically with Vin = 48V and air flowing from pin 3 to pin 1 at a rate of 200LFM (1.0 m/s).



Fig. 1.2V.7: Power dissipation vs. load current and input voltage for SQ48T/S15012 converter mounted vertically with air flowing from pin 3 to pin 1 at a rate of 300 LFM (1.5 m/s) and Ta = 25°C.



Fig. 1.2V.8: Power dissipation vs. load current and ambient temperature for SQ48T/S15012 converter mounted vertically with Vin = 48V and air flowing from pin 3 to pin 1 at a rate of 200LFM (1.0m/s).



Fig. 1.2V.9: Turn-on transient at full rated load current (resistive) with no output capacitor at  $V_{in} = 48V$ , triggered via ON/OFF pin. Top trace: ON/OFF signal (5V/div.). Bottom trace: output voltage (0.5V/div.). Time scale: 2ms/div.



Fig. 1.2V.10: Turn-on transient at full rated load current (resistive) plus 10,000  $\mu F$  at  $V_{in} = 48V$ , triggered via ON/OFF pin. Top trace: ON/OFF signal (5V/div.). Bottom trace: output voltage (0.5V/div.). Time scale: 2ms/div.



Fig. 1.2V.11: Output voltage response to load current step-change (3.75 A - 7.5 A - 3.75 A) at  $V_{in} = 48V$ . Top trace: output voltage (100mV/div.). Bottom trace: load current (5A/div.). Current slew rate: 0.1A/ $\mu s$ .  $C_o = 1\mu F$  ceramic. Time scale: 0.2 ms/div.



Fig. 1.2V.12: Output voltage response to load current step-change (3.75 A - 7.5 A - 3.75 A) at  $V_{in} = 48V$ . Top trace: output voltage (100 mV/div.). Bottom trace: load current (5A/div.). Current slew rate: 5 A/ $\mu s$ .  $C_o = 450\mu F$  tantalum + 1 $\mu F$  ceramic. Time scale: 0.2 ms/div.



Fig. 1.2V.13: Output voltage ripple (20 mV/div.) at full rated load current into a resistive load with  $C_o = 10\mu\text{F}$  tantalum +  $1\mu\text{F}$  ceramic and  $V_{in} = 48\text{V}$ . Time scale:  $1\mu\text{s}/\text{div}$ .

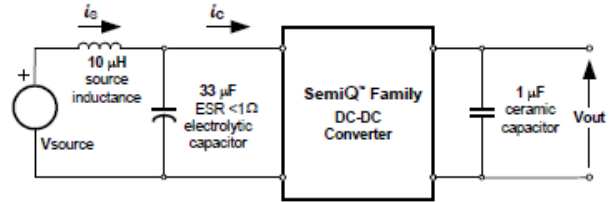

Fig. 1.2V.14: Test Setup for measuring input reflected ripple currents,  $i_c$  and  $i_s$



Fig. 1.2V.15: Input reflected ripple current,  $i_c$  (100 mA/div.), measured at input terminals at full rated load current and  $V_{in} = 48\text{V}$ . Refer to Fig. 1.2V.14 for test setup. Time scale:  $1\mu\text{s}/\text{div}$ .



Fig. 1.2V.16: Input reflected ripple current,  $i_s$  (10 mA/div.), measured through  $10\mu\text{H}$  at the source at full rated full rated load current and  $V_{in} = 48\text{V}$ . Refer to Fig. 1.2V.14 for test setup. Time scale:  $1\mu\text{s}/\text{div}$ .



Fig. 1.2V.17: Output voltage vs. load current showing current limit point and converter shutdown point. Input voltage has almost no effect on current limit characteristic.



Fig. 1.2V.18: Load current (top trace, 20A/div., 20 ms/div.) into a  $10\text{m}\Omega$  short circuit during restart, at  $V_{in} = 48\text{V}$ . Bottom trace (20A/div., 1ms/div.) is an expansion of the on-time portion of the top trace.

## 5.11 SQ48T/S15010 (1.0 Volt Out)

Conditions:  $T_A = 25\text{ }^\circ\text{C}$ , Airflow = 300 LFM (1.5 m/s),  $V_{in} = 48\text{ VDC}$ ,  $V_{out} = 1.0\text{ VDC}$ , unless otherwise specified.

PARAMETER	CONDITIONS/DESCRIPTION	MIN	TYP	MAX	UNITS
<b>Input Characteristics</b>					
Maximum Input Current	15 ADC, 1.0 VDC Out @ 36 VDC In			0.52	ADC
Input Stand-by Current	$V_{in} = 48\text{V}$ , converter disabled		3		mADC
Input No Load Current (0 load on the output)	$V_{in} = 48\text{V}$ , converter enabled		22		mADC
Input Reflected-Ripple Current	25MHz bandwidth		7.5		mA <sub>PK-PK</sub>
<b>Output Characteristics</b>					
Output Voltage Set Point (no load)		0.990	1.000	1.010	VDC
Output Regulation					
Over Line			$\pm 1$	$\pm 2$	mV
Over Load			$\pm 1$	$\pm 3$	mV
Output Voltage Range	Over line, load and temperature <sup>12</sup>	0.985		1.015	VDC
Output Ripple and Noise - 25 MHz bandwidth	Full load + 10 $\mu\text{F}$ tantalum + 1 $\mu\text{F}$ ceramic		30	50	mV <sub>PK-PK</sub>
External Load Capacitance	Plus full load (resistive)			15,000	$\mu\text{F}$
Output Current Range		0		15	ADC
Current Limit Inception	Non-latching	15.75	18	20	ADC
Peak Short-Circuit Current	Non-latching, Short =10 m $\Omega$ .		30	40	A
RMS Short-Circuit Current	Non-latching			5.3	Arms
<b>Dynamic Response</b>					
Load Change 25% of $I_{out}$ Max, $di/dt = 0.1\text{ A}/\mu\text{s}$	$C_o = 1\text{ }\mu\text{F}$ ceramic		90		mV
$di/dt = 5\text{ A}/\mu\text{s}$	$C_o = 450\text{ }\mu\text{F}$ tantalum + 1 $\mu\text{F}$ ceramic		140		mV
Settling Time to 1%			100		$\mu\text{s}$
<b>Efficiency</b>					
100% Load			80.5		%
50% Load			81.0		%

<sup>12</sup> -40  $^\circ\text{C}$  to 85  $^\circ\text{C}$ .



Figure 1.0V.1 Available load current vs. ambient air temperature and airflow rates for SQ48T15010 converter with D height pins mounted vertically with  $V_{in} = 48V$ , air flowing from pin 3 to pin 1, and maximum FET temperature  $\leq 120^{\circ}C$ .



Figure 1.0V.2 Available load current vs. ambient air temperature and airflow rates for SQ48T15010 converter with D height pins mounted horizontally with  $V_{in} = 48V$ , air flowing from pin 3 to pin 1, and maximum FET temperature  $\leq 120^{\circ}C$ .



Figure 1.0V.3 Available load current vs. ambient air temperature and airflow rates for SQ48S15010 converter with D height pins mounted vertically with  $V_{in} = 48V$ , air flowing from pin 3 to pin 1, and maximum FET temperature  $\leq 120^{\circ}C$ .



Figure 1.0V.4 Available load current vs. ambient air temperature and airflow rates for SQ48S15010 converter with D height pins mounted horizontally with  $V_{in} = 48V$ , air flowing from pin 3 to pin 1, and maximum FET temperature  $\leq 120^{\circ}C$ .



Fig. 1.0V.5: Efficiency vs. load current and input voltage for SQ48T/S15010 converter mounted vertically with air flowing from pin 3 to pin 1 at a rate of 300LFM (1.5 m/s) and  $T_a = 25^\circ\text{C}$ .



Fig. 1.0V.6: Efficiency vs. load current and ambient temperature for SQ48T/S15010 converter mounted vertically with  $V_{in} = 48\text{V}$  and air flowing from pin 3 to pin 1 at a rate of 200LFM (1.0 m/s).

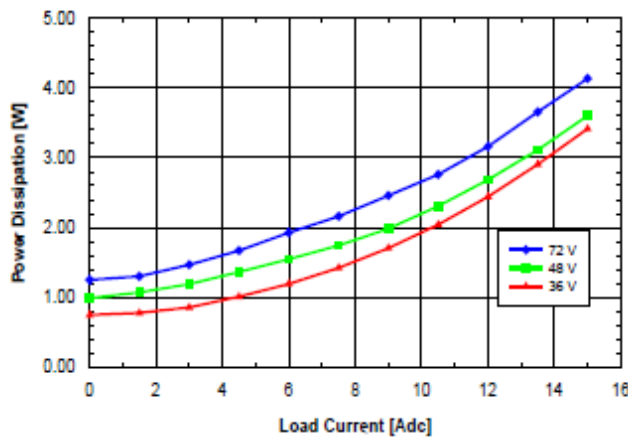

Fig. 1.0V.7: Power dissipation vs. load current and input voltage for SQ48T/S15010 converter mounted vertically with air flowing from pin 3 to pin 1 at a rate of 300 LFM (1.5 m/s) and  $T_a = 25^\circ\text{C}$ .



Fig. 1.0V.8: Power dissipation vs. load current and ambient temperature for SQ48T/S15010 converter mounted vertically with  $V_{in} = 48\text{V}$  and air flowing from pin 3 to pin 1 at a rate of 200LFM (1.0m/s).



Fig. 1.0V.9: Turn-on transient at full rated load current (resistive) with no output capacitor at  $V_{in} = 48V$ , triggered via ON/OFF pin. Top trace: ON/OFF signal (5V/div.). Bottom trace: output voltage (0.5V/div.). Time scale: 2ms/div.



Fig. 1.0V.10: Turn-on transient at full rated load current (resistive) plus 10,000  $\mu F$  at  $V_{in} = 48V$ , triggered via ON/OFF pin. Top trace: ON/OFF signal (5V/div.). Bottom trace: output voltage (0.5V/div.). Time scale: 2ms/div.



Fig. 1.0V.11: Output voltage response to load current step-change (3.75 A - 7.5 A - 3.75 A) at  $V_{in} = 48V$ . Top trace: output voltage (100mV/div.). Bottom trace: load current (5A/div.). Current slew rate: 0.1A/ $\mu s$ .  $C_o = 1\mu F$  ceramic. Time scale: 0.2 ms/div.



Fig. 1.0V.12: Output voltage response to load current step-change (3.75 A - 7.5 A - 3.75 A) at  $V_{in} = 48V$ . Top trace: output voltage (100 mV/div.). Bottom trace: load current (5A/div.). Current slew rate: 5 A/ $\mu s$ .  $C_o = 450\mu F$  tantalum + 1 $\mu F$  ceramic. Time scale: 0.2 ms/div.



Fig. 1.0V.13: Output voltage ripple (20 mV/div.) at full rated load current into a resistive load with  $C_o = 10\mu\text{F}$  tantalum +  $1\mu\text{F}$  ceramic and  $V_{in} = 48\text{V}$ . Time scale:  $1\mu\text{s}/\text{div}$ .



Fig. 1.0V.14: Test Setup for measuring input reflected ripple currents,  $i_c$  and  $i_s$



Fig. 1.0V.15: Input reflected ripple current,  $i_c$  (100 mA/div.), measured at input terminals at full rated load current and  $V_{in} = 48\text{V}$ . Refer to Fig. 1.0V.14 for test setup. Time scale:  $1\mu\text{s}/\text{div}$ .



Fig. 1.0V.16: Input reflected ripple current,  $i_s$  (10 mA/div.), measured through  $10\mu\text{H}$  at the source at full rated full rated load current and  $V_{in} = 48\text{V}$ . Refer to Fig. 1.0V.14 for test setup. Time scale:  $1\mu\text{s}/\text{div}$ .



Fig. 1.0V.17: Output voltage vs. load current showing current limit point and converter shutdown point. Input voltage has almost no effect on current limit characteristic.



Fig. 1.0V.18: Load current (top trace, 20A/div., 20 ms/div.) into a  $10\text{m}\Omega$  short circuit during restart, at  $V_{in} = 48\text{V}$ . Bottom trace (20A/div., 1ms/div.) is an expansion of the on-time portion of the top trace.

6. MECHANICAL PARAMETERS

SQ48S Pinout (Surface Mount)

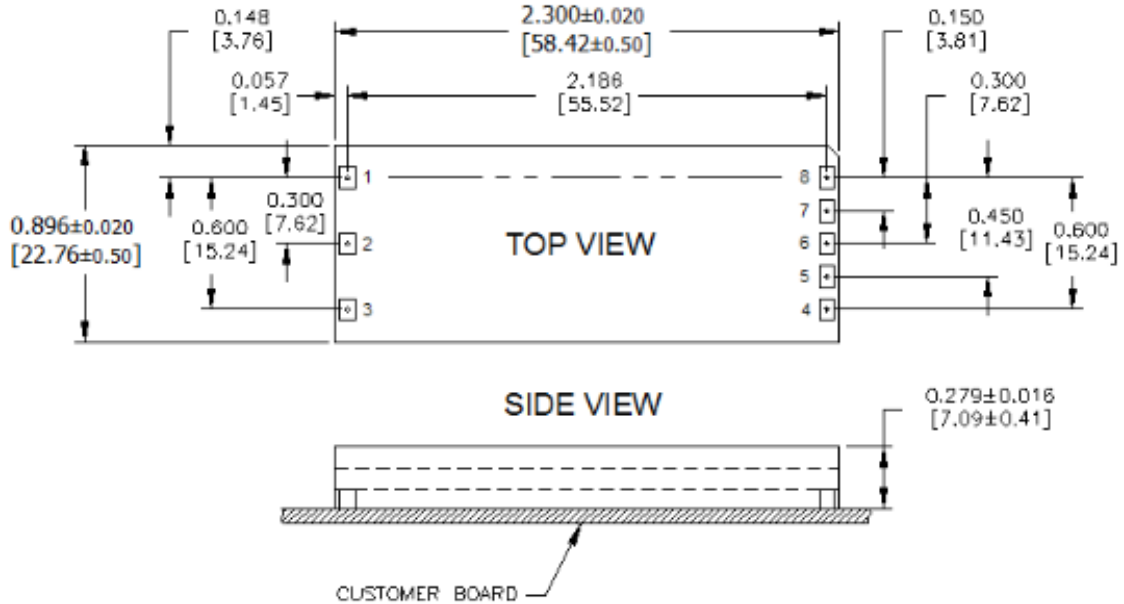

SQ48T Pinout (Through-hole)



HEIGHT OPTION	HT (MAX. HEIGHT)	CL (MIN. CLEARANCE)
		+0.000 [+0.00] -0.038 [- 0.97]
A	0.303 [7.69]	0.030 [0.77]
B	0.336 [8.53]	0.063 [1.60]
C	0.500 [12.70]	0.227 [5.77]
D	0.400 [10.16]	0.127 [3.23]
E	0.282 [7.16]	0.009 [0.23]

PIN OPTION	PL PIN LENGTH
A	0.188 [4.77]
B	0.145 [3.68]
C	0.110 [2.79]

PAD/PIN CONNECTIONS	
Pad/Pin #	Function
1	Vin (+)
2	ON/OFF
3	Vin (-)
4	Vout (-)
5	SENSE(-)
6	TRIM
7	SENSE(+)
8	Vout (+)

### SQE48S Platform Notes

- All dimensions are in inches [mm]
- Connector Material: Copper
- Connector Finish: Gold over Nickel
- Converter Weight: 0.66 oz [18.5 g]
- Recommended Surface-Mount Pads:  
Min. 0.080" X 0.112" [2.03 x 2.84]  
Max. 0.092" X 0.124" [2.34 x 3.15]

### SQE48T Platform Notes

- All dimensions are in inches [mm]
- Pins 1-3 and 5-7 are Ø 0.040" [1.02] with Ø 0.078" [1.98] shoulder
- Pins 4 and 8 are Ø 0.062" [1.57] without shoulder
- Pin Material: Brass
- Pin Finish: Tin / Lead over Nickel or Matte Tin over Nickel for "G" version
- Converter Weight: 0.53 oz [15 g]



Asia-Pacific  
+86 755 298 85888

Europe, Middle East  
+353 61 225 977

North America  
+1 408 785 5200

## 7. ORDERING INFORMATION

Product Series	Input Voltage	Mounting Scheme	Rated Load Current	Output Voltage	ON/OFF Logic	Maximum Height [HT]	Pin Length [PL]	Special Features	Environmental	
<i>SQ</i>	<i>48</i>	<i>T</i>	<i>15</i>	<i>012</i>	-	<i>N</i>	<i>B</i>	<i>A</i>	<i>0</i>	
One-Eighth Brick Format	36-75 V	S ⇒ Surface Mount T ⇒ Through-hole	15 ⇒ 15 A (1.0 – 3.3 V)	010 ⇒ 1.0 V 012 ⇒ 1.2 V 015 ⇒ 1.5 V	N ⇒ Negative  P ⇒ Positive	<u>SMT</u> S ⇒ 0.273"	<u>SMT</u> 0 ⇒ 0.00"	0 ⇒ STD  T ⇒ Alternative Trim Option (For 1.2 V, 1.0 V only)	No Suffix ⇒ RoHS lead-solder-exemption compliant  G ⇒ RoHS compliant for all six substances	
			10 ⇒ 10 A (5.0 V)	018 ⇒ 1.8 V 020 ⇒ 2.0 V		<u>Through hole</u> A ⇒ 0.303"				<u>Through hole</u> A ⇒ 0.188"
			08 ⇒ 8 A (6.0 V)	025 ⇒ 2.5 V 033 ⇒ 3.3 V		B ⇒ 0.336"				B ⇒ 0.145"
			05 ⇒ 5.3 A (8.0 V)	050 ⇒ 5.0 V 060 ⇒ 6.0 V		C ⇒ 0.500"				C ⇒ 0.110"
			04 ⇒ 4 A (12.0 V)	080 ⇒ 8.0 V 120 ⇒ 12.0 V		D ⇒ 0.400"				E ⇒ 0.282"

The example above describes P/N SQ48T15012-NBA0: 36-75 V input, through-hole mounting, 15 A @ 1.2 V output, negative ON/OFF logic, a maximum height of 0.336", a through the board pin length of 0.188", standard trim equations, and Eutectic Tin/Lead solder. Please consult factory for the complete list of available options.

**For more information on these products consult: [tech.support@psbel.com](mailto:tech.support@psbel.com)**

**NUCLEAR AND MEDICAL APPLICATIONS** - Products are not designed or intended for use as critical components in life support systems, equipment used in hazardous environments, or nuclear control systems.

**TECHNICAL REVISIONS** - The appearance of products, including safety agency certifications pictured on labels, may change depending on the date manufactured. Specifications are subject to change without notice.



[tech.support@psbel.com](mailto:tech.support@psbel.com)  
[belpowersolutions.com](http://belpowersolutions.com)

## Looking for pricing, stock, or lifecycle information?

Click below to explore more details on WIN SOURCE:

- [View SQ48T15015-NAB0G-S100 on WIN SOURCE](#)
- [Bel Power Solutions Information](#)

## Optimize Your Supply Chain with WIN SOURCE Solutions

- ✓ Global Sourcing Solution
- ✓ Obsolete Management
- ✓ Cost Control Management
- ✓ Shortage Management
- ✓ Alternative Solution
- ✓ Excess Inventory Management