



**THE DATASHEET OF
SLIN-12E1ALG**



SLIN-12E1A

Non-Isolated DC-DC Converter

The SLIN-12E1A power modules are non-isolated DC-DC converters that can deliver up to 12 A of output current. These modules operate over a wide range of input voltage ($V_{IN} = 4.5 - 14$ VDC) and provide a precisely regulated output voltage from 0.69 VDC to 5.5 VDC, programmable via an external resistor.

Two new features added with this family of products are the ability to externally tune the voltage control loop and frequency synchronization. Other features include remote on/off, adjustable output voltage, over current and over temperature protection, power good and output voltage sequencing.

The Tunable Loop™, allows the user to optimize the dynamic response of the converter to match the load with reduced amount of output capacitance leading to savings on cost and PWB area.



**TUNABLE
LOOP™**
A LINEAGE POWER TRADEMARK



Key Features & Benefits

- Wide Input Voltage Range
- Fixed Switching Frequency
- Power Good Signal
- Remote Sense
- Remote On/Off
- Ability to Sink and Source Current
- Cost Efficient Open Frame Design
- Over Temperature Protection
- Output Over Current Protection
- Tunable Loop™ (a Registered Trademark of Lineage Power Systems) to Optimize Dynamic Output Voltage Response
- Flexible Output Voltage Sequencing
- Fixed Switching Frequency & Ability to Synchronize with External Clock
- Class II, Category 2, Non-Isolated DC-DC Converter (refer to IPC-9592B)
- Certificated to UL/CSA 62368-1

Applications

- Distributed Power Architectures
- Intermediate Bus Voltage Applications
- Telecommunications Equipment
- Servers and Storage Applications
- Networking Equipment
- Industrial Equipment

1. MODEL SELECTION

MODEL NUMBER ACTIVE HIGH	MODEL NUMBER ACTIVE LOW	OUTPUT VOLTAGE	INPUT VOLTAGE	MAX. OUTPUT CURRENT	TYPICAL EFFICIENCY
SLIN-12E1A0G	SLIN-12E1ALG	0.69 - 5.5 VDC	4.5 - 14 VDC	12 A	94.3%
SLIN-12E1A0R	SLIN-12E1ALR				

PART NUMBER EXPLANATION

S	LIN	-	12	E	1A	x	y
Mounting Type	Series Code		Output Current	Input Voltage Range	Sequencing or not	Active Logic	Package Type
Surface Mount	SLIN Series		12 A	4.5 – 14 V	with Sequencing	L – Active Low 0 – Active High	G – Tray Package R – Tape and Reel Package

2. ABSOLUTE MAXIMUM RATINGS

PARAMETER	DESCRIPTION	MIN	TYP	MAX	UNITS
Continuous Input Voltage		-0.3	-	15	V
Voltage on SEQ terminal		-0.3	-	V _{IN}	V
Voltage on SYNC terminal		-0.3	-	12	V
Voltage on PG terminal		-0.3	-	6	V
Ambient Temperature		-40	-	85	°C
Storage Temperature		-55	-	125	°C
Altitude		-	-	2000	m

NOTE: Stresses in excess of the absolute maximum ratings can cause permanent damage to the device. These are absolute stress ratings only, functional operation of the device is not implied at these or any other conditions in excess of those given in the operations sections of the data sheet. Exposure to absolute maximum ratings for extended periods can adversely affect the device reliability.

3. INPUT SPECIFICATIONS

All specifications are typical at 25°C unless otherwise stated.

PARAMETER	DESCRIPTION	MIN	TYP	MAX	UNIT
Operating Input Voltage		4.5	-	14	V
Input Current (full load)	$V_{IN} = 4.5 \text{ V to } 14 \text{ V}$	-	-	11.5	A
Input Current (no load)	$V_O = 0.69 \text{ V}, V_{IN} = 10 \text{ V}, I_O = 0, \text{ module enabled}$	-	26	-	mA
	$V_O = 3.3 \text{ V}, V_{IN} = 12 \text{ V}, I_O = 0, \text{ module enabled}$	-	60	-	mA
Input Stand-by Current	$V_{IN} = 12 \text{ V}, \text{ module disabled}$	-	1.2	-	mA
Input Reflected Ripple Current (pk-pk)	5 Hz to 20 MHz, 1 μH source impedance; $V_{IN} = 0 \text{ to } 14 \text{ V}, I_O = I_{O,max}$	-	70	-	mA
I^2t Inrush Current Transient		-	-	1	A ² s
Input Ripple Rejection (120 Hz)		-	45	-	dB
Turn-on Threshold		-	4.45	-	V
Turn-off Threshold		-	4.2	-	V
Hysteresis		-	0.25	-	V

CAUTION: This converter is not internally fused. An input line fuse must be used in application.

This power module can be used in a wide variety of applications, ranging from simple standalone operation to an integrated part of sophisticated power architecture. To preserve maximum flexibility, internal fusing is not included; however, to achieve maximum safety and system protection, always use an input line fuse. The safety agencies require a fast-acting fuse with a maximum rating of 15 A. Based on the information provided in this data sheet on inrush energy and maximum DC input current, the same type of fuse with a lower rating can be used. Refer to the fuse manufacturer's data sheet for further information.

4. OUTPUT SPECIFICATIONS

All specifications are typical at nominal input, full load at 25°C unless otherwise stated.

PARAMETER		DESCRIPTION	MIN	TYP	MAX	UNIT
Output Voltage Set Point		with 0.5% tolerance for external resistor used to set output voltage	-1.5	-	+1.5	%Vo,set
Output Voltage		Over entire operating input voltage range, resistive load, and temperature conditions until end of life	-2.5	-	+2.5	%Vo,set
Adjustment Range		Selected by an external resistor	0.69	-	5.5	V
Remote Sense Range			-	-	0.5	V
Load Regulation	$V_O \geq 2.5V$	$I_O = I_{O, \min}$ to $I_{O, \max}$	-	-	10	mV
	$V_O < 2.5V$		-	-	5	mV
Line Regulation	$V_O \geq 2.5V$	$V_{IN} = V_{IN, \min}$ to $V_{IN, \max}$	-	-	0.4	%Vo,set
	$V_O < 2.5V$		-	-	10	mV
Temperature Regulation (-40°C to +85°C)		$V_O < 2.5V$, $T_{ref} = T_{A, \min}$ to $T_{A, \max}$	-	-	0.5	%Vo,set
Ripple and Noise (Pk-Pk)		5 Hz to 20 MHz BW, $V_{IN} = V_{IN, \text{nom}}$ and $I_O = I_{O, \min}$ to $I_{O, \max}$ Co = 0.1 μF // 10 μF ceramic capacitors)	-	65	80	mV
Ripple and Noise (RMS)			-	23	28	mV
Output Current Range			0	-	12	A
Output DC Current Limit		Hiccup Mode	-	150	-	%Io,max
Output Short-Circuit Current		$V_O \leq 250$ mV, Hiccup Mode	-	2	-	A
Output Capacitance	$ESR \geq 1$ m Ω	Without the Tunable Loop™	0	-	100	μF
	$ESR \geq 0.15$ m Ω	With the Tunable Loop™	0	-	1000	μF
	$ESR \geq 10$ m Ω	With the Tunable Loop™	0	-	5000	μF
Turn-On Delay Time		Case 1: On/Off input is enabled and then input power is applied (delay from instant at which $V_{IN} = V_{IN, \min}$ until $V_O = 10\%$ of $V_{O, \text{set}}$)	-	2	-	ms
		Case 2: Input power is applied for at least one second and then the On/Off input is enabled (delay from instant at which Von/Off is enabled until $V_O = 10\%$ of $V_{O, \text{set}}$)	-	2	-	ms
Output Voltage Rise Time		Time for V_O to rise from 10% of $V_{O, \text{set}}$ to 90% of $V_{O, \text{set}}$	-	5	-	ms
Output Voltage Overshoot		$V_{in} = V_{in, \min}$ to $V_{in, \max}$, $I_O = I_{O, \min}$ to $I_{O, \max}$, With or without maximum external capacitance	-	-	3	%Vo,set
Dynamic Load Response						
ΔV 50%~100% of Max Load						
Overshoot			-	360	-	mV
Settling Time		di/dt = 1 A/ μs , $V_{in} = V_{in, \text{nom}}$, $T_a = 25^\circ\text{C}$, with a 1 μF ceramic capacitor and a 10 μF ceramic capacitor.	-	50	-	μs
ΔV 100%~50% of Max Load						
Overshoot			-	400	-	mV
Settling Time			-	50	-	μs

Notes:

1. Some output voltages may not be possible depending on the input voltage.
2. External capacitors may require using the new Tunable Loop™ feature to ensure that the module is stable as well as getting the best transient response (See the Tunable Loop™ section for details).
3. Unless otherwise indicated, specifications apply over entire operating input voltage range, resistive load, and temperature conditions.

5. GENERAL SPECIFICATIONS

PARAMETER	DESCRIPTION	MIN	TYP	MAX	UNIT
Efficiency	Vo = 0.69 V		76.0		%
	Vo = 1.2 V		83.0		
	Vo = 1.8 V		87.6		
	Vo = 2.5 V		90.2		
	Vo = 3.3 V		92.2		
	Vo = 5.0 V		94.3		
Switching Frequency		-	500	-	kHz
Over Temperature Protection		-	133	-	°C
Sequencing Delay Time	Delay from VIN, min to application of voltage on SEQ pin	10	-	-	ms
Tracking Accuracy	Power-Up: 0.5 V/ms		-	100	mV
	Power-Down: 0.5 V/ms		-	150	mV
PGOOD (Power Good)					
Output Voltage Limit for PGOOD	Signal Interface Open Drain, Vsupply ≤ 6 VDC	89.1	-	110.8	%Vo,set
Pulldown resistance of PGOOD pin		-	7	50	Ω
Weight		-	3.68	-	g
MTBF	Calculated Per Telcordia Issue 2 Method 1 Case 3 (Io = 0.8 Io, max, Ta = 40°C)	-	16,250,892	-	hours
Dimensions (L x W x H)			0.80 x 0.45 x 0.334		inch
			20.32 x 11.43 x 8.50		mm
Frequency Synchronization					
Synchronization Frequency Range		520	-	600	kHz
High-Level Input Voltage		2.5	-	-	V
Low-Level Input Voltage		-	-	0.8	V
Input Current, SYNC		-	-	1	mA
Minimum Pulse Width, SYNC		250	-	-	ns
Minimum Setup/Hold Time, SYNC		250	-	-	ns

Note: Unless otherwise indicated, specifications apply over entire operating input voltage range, resistive load, and temperature conditions.

6. EFFICIENCY DATA

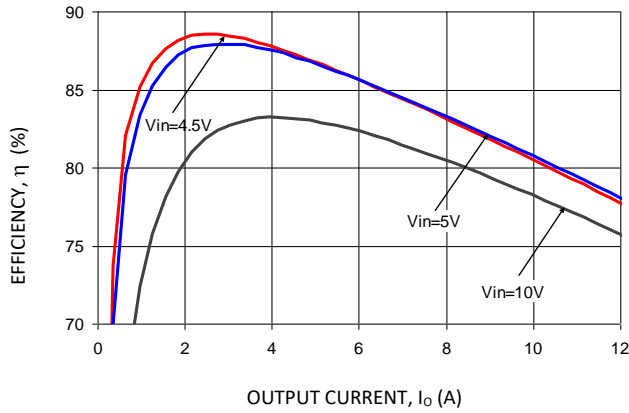

Figure 1. $V_o = 0.69\text{ V}$

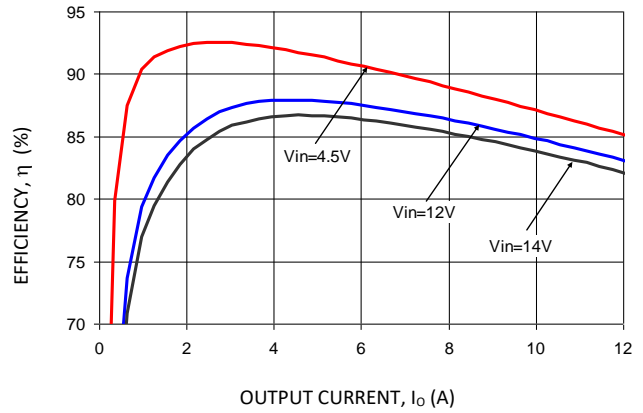

Figure 2. $V_o = 1.2\text{ V}$

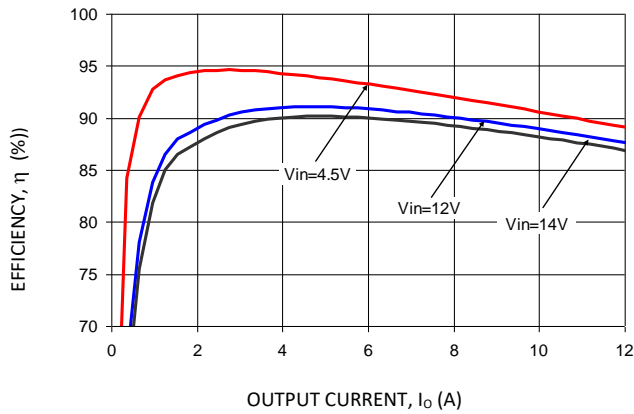

Figure 3. $V_o = 1.8\text{ V}$

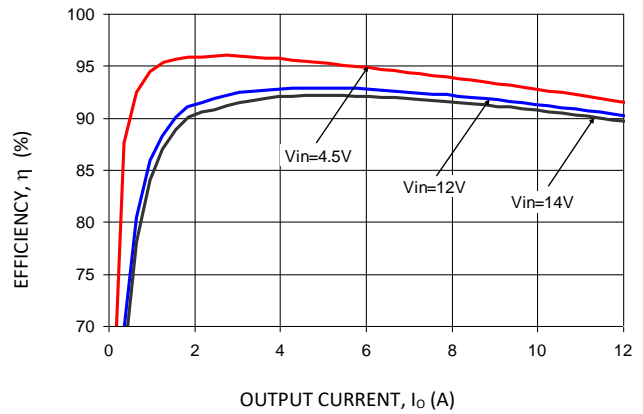

Figure 4. $V_o = 2.5\text{ V}$

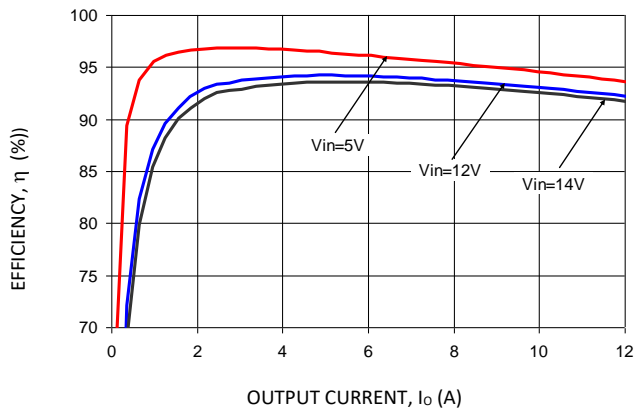

Figure 5. $V_o = 3.3\text{ V}$

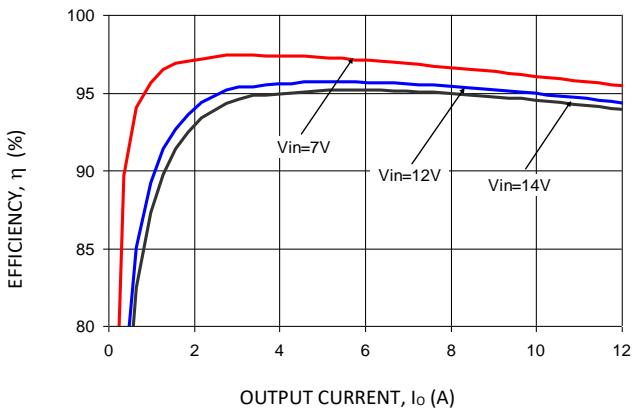

Figure 6. $V_o = 5.0\text{ V}$

7. THERMAL DERATING CURVE

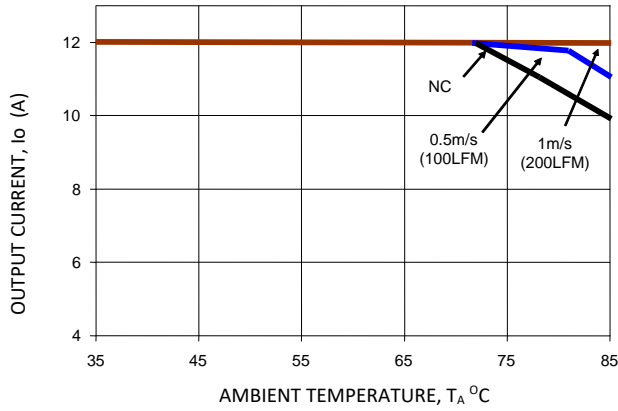

Figure 7. $V_o = 0.69 V$

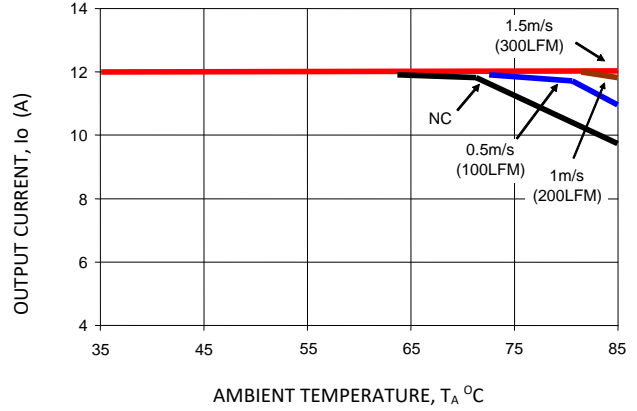

Figure 8. $V_o = 1.2 V$

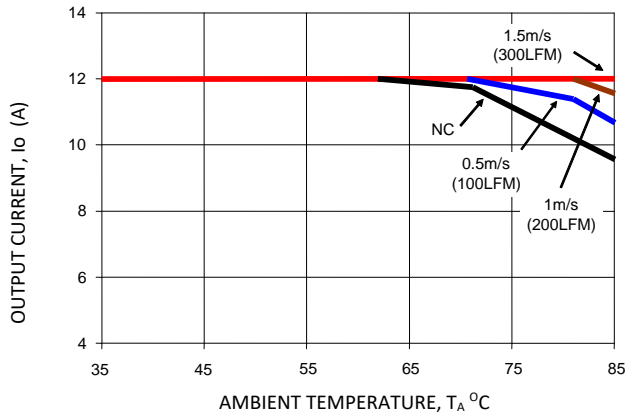

Figure 9. $V_o = 1.8 V$

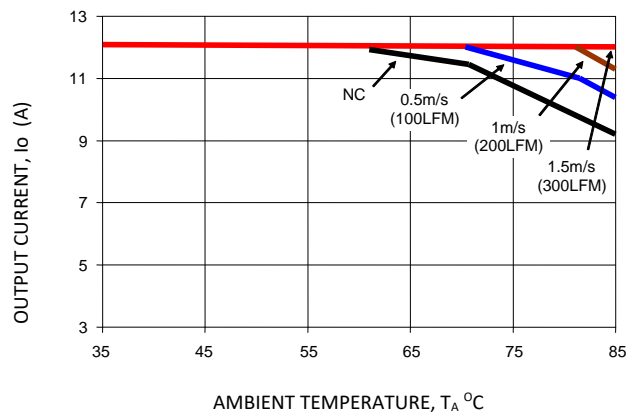

Figure 10. $V_o = 2.5 V$

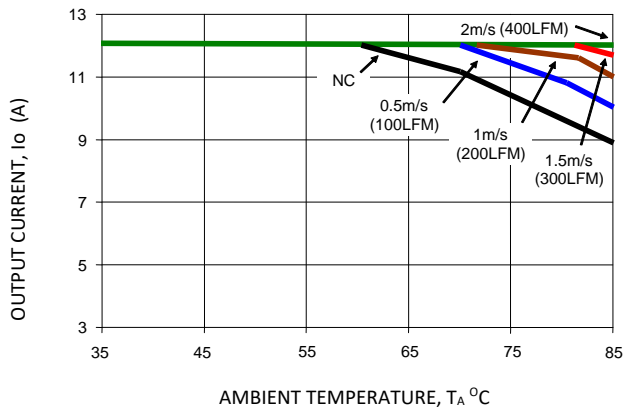

Figure 11. $V_o = 3.3 V$

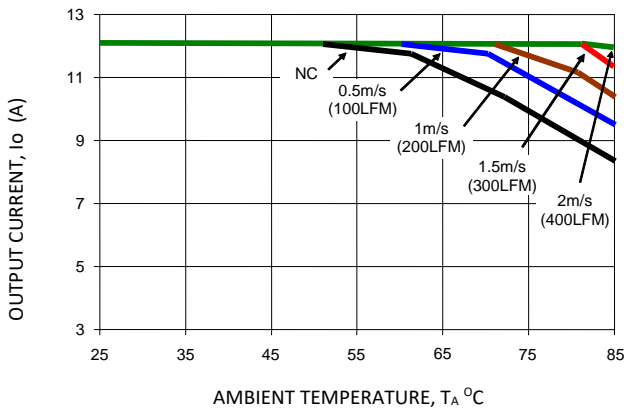

Figure 12. $V_o = 5.0 V$

8. RIPPLE AND NOISE WAVEFORMS

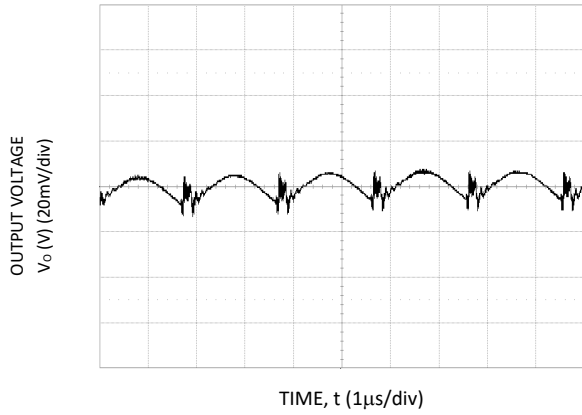

Figure 13. $V_{in} = 12\text{ V}$, $V_o = 0.69\text{ V}$, $I_o = I_{o,max}$

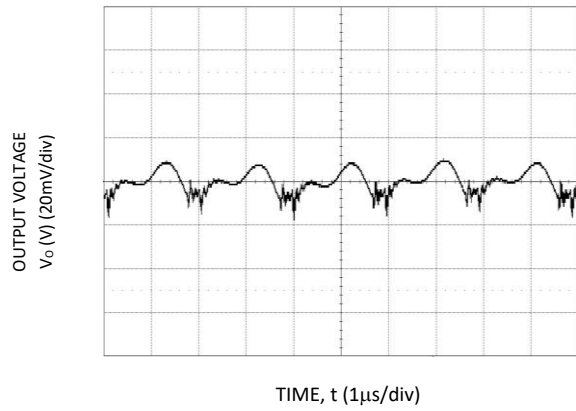

Figure 14. $V_{in} = 12\text{ V}$, $V_o = 1.2\text{ V}$, $I_o = I_{o,max}$

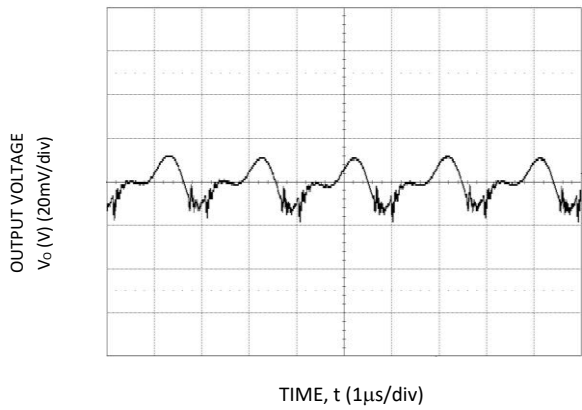

Figure 15. $V_{in} = 12\text{ V}$, $V_o = 1.8\text{ V}$, $I_o = I_{o,max}$

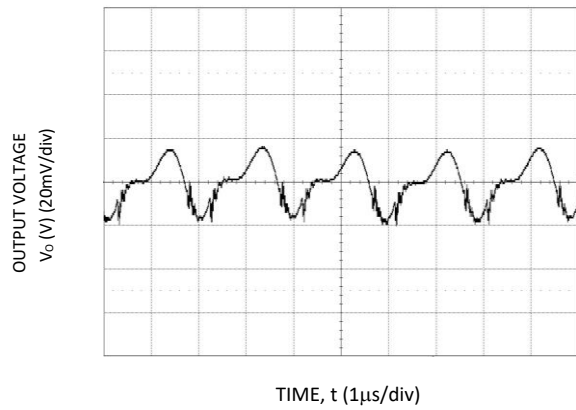

Figure 16. $V_{in} = 12\text{ V}$, $V_o = 2.5\text{ V}$, $I_o = I_{o,max}$

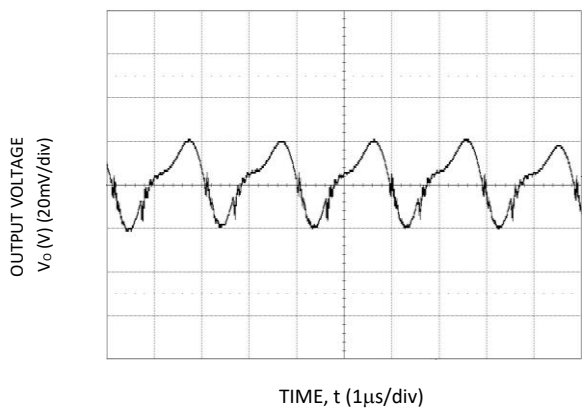

Figure 17. $V_{in} = 12\text{ V}$, $V_o = 3.3\text{ V}$, $I_o = I_{o,max}$

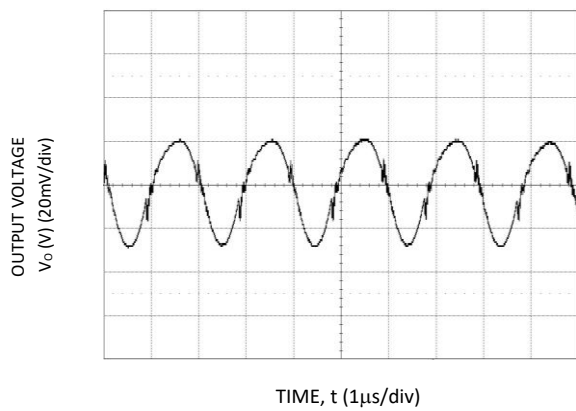

Figure 18. $V_{in} = 12\text{ V}$, $V_o = 5.0\text{ V}$, $I_o = I_{o,max}$

9. TRANSIENT RESPONSE WAVEFORMS

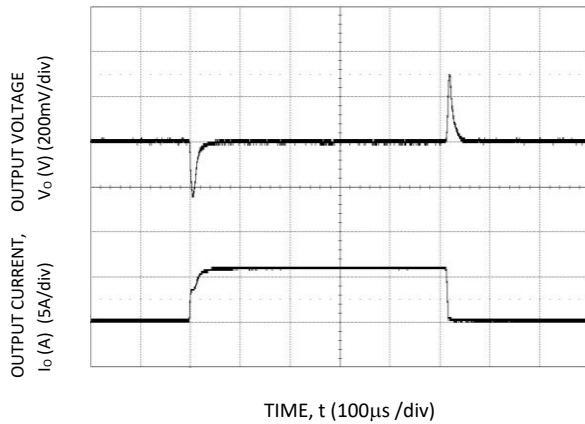

Figure 19. Transient Response to Dynamic Load Change from 0% to 50% to 0%, $V_o = 0.69\text{ V}$

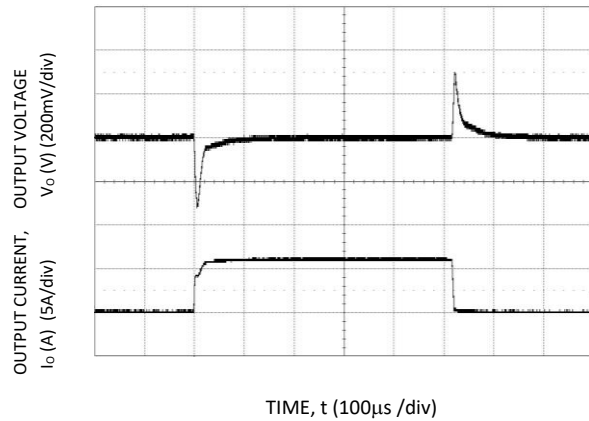

Figure 20. Transient Response to Dynamic Load Change from 0% to 50% to 0%, $V_o = 1.2\text{ V}$

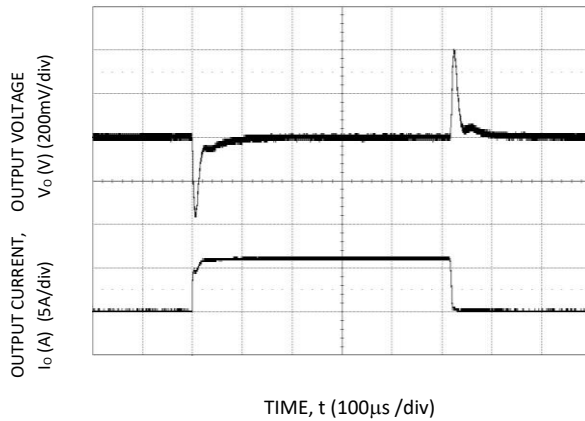

Figure 21. Transient Response to Dynamic Load Change from 0% to 50% to 0%, $V_o = 1.8\text{ V}$

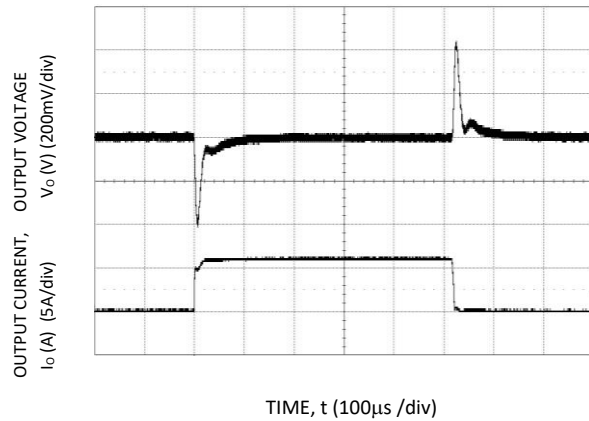

Figure 22. Transient Response to Dynamic Load Change from 0% to 50% to 0%, $V_o = 2.5\text{ V}$

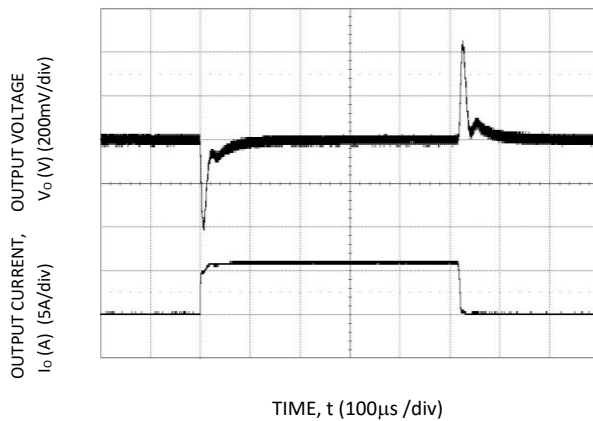

Figure 23. Transient Response to Dynamic Load Change from 0% to 50% to 0%, $V_o = 3.3\text{ V}$

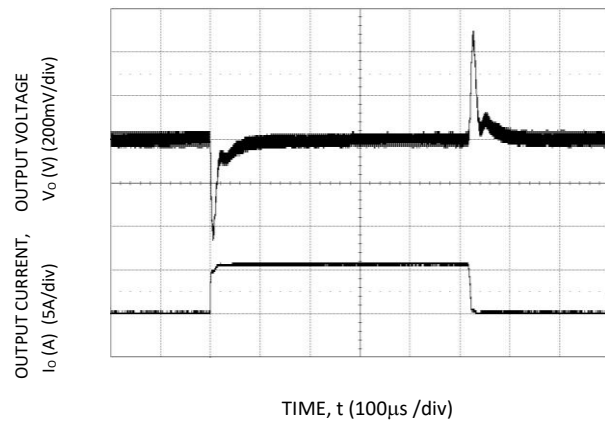

Figure 24. Transient Response to Dynamic Load Change from 0% to 50% to 0%, $V_o = 5.0\text{ V}$

10. STARTUP TIME

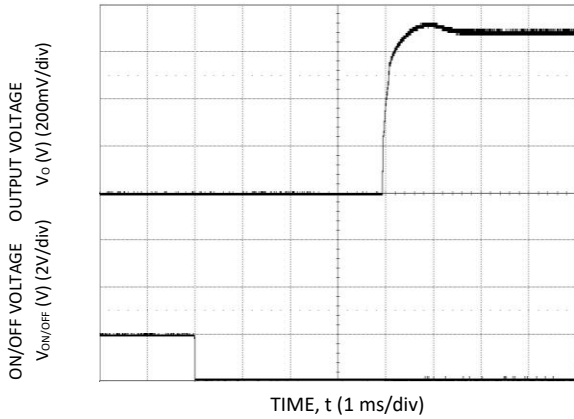

Figure 25. Start-up Using On/Off Voltage ($I_o = I_{o,max}$), $V_o = 0.69\text{ V}$

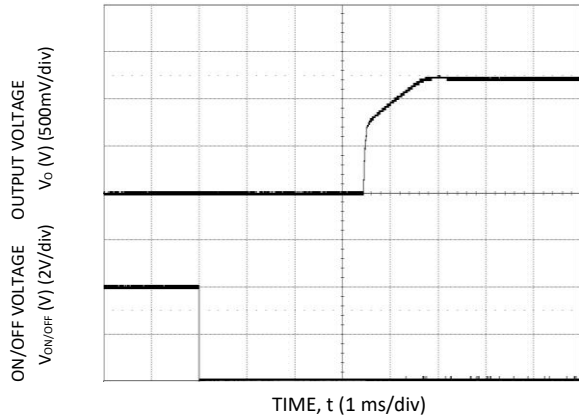

Figure 26. Start-up Using On/Off Voltage ($I_o = I_{o,max}$), $V_o = 1.2\text{ V}$

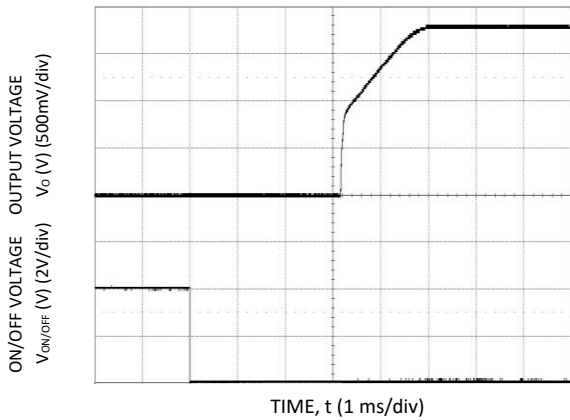

Figure 27. Start-up Using On/Off Voltage ($I_o = I_{o,max}$), $V_o = 1.8\text{ V}$

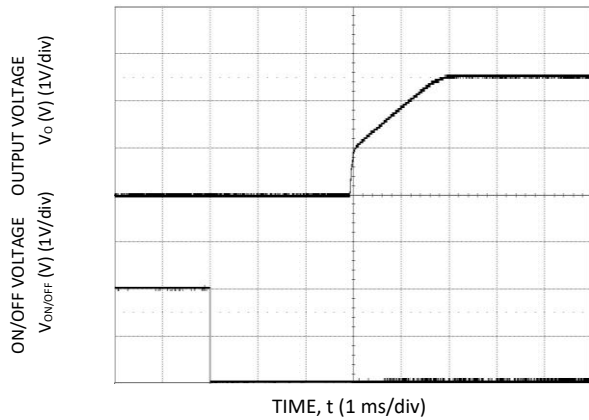

Figure 28. Start-up Using On/Off Voltage ($I_o = I_{o,max}$), $V_o = 2.5\text{ V}$

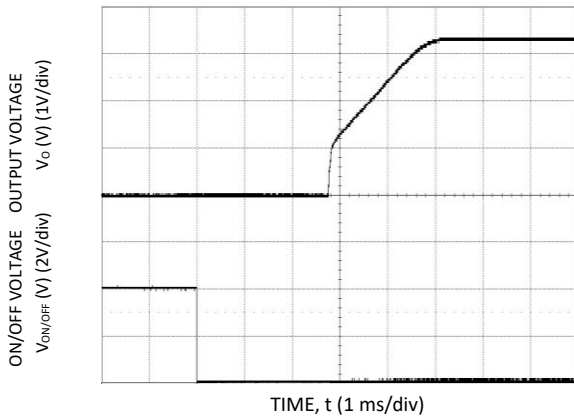

Figure 29. Start-up Using On/Off Voltage ($I_o = I_{o,max}$), $V_o = 3.3\text{ V}$

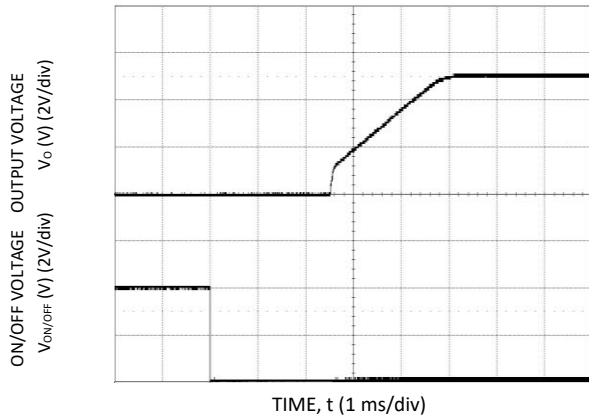

Figure 30. Start-up Using On/Off Voltage ($I_o = I_{o,max}$), $V_o = 5.0\text{ V}$

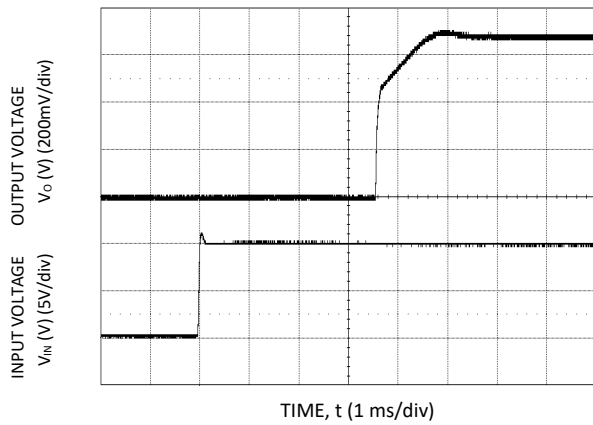

Figure 31. Start-up Using Input Voltage ($V_{IN} = 10\text{ V}$, $I_o = I_{o,max}$), $V_o = 0.69\text{ V}$

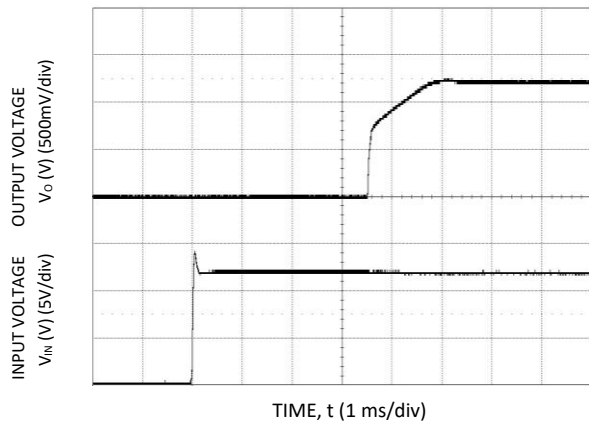

Figure 32. Start-up Using Input Voltage ($V_{IN} = 12\text{ V}$, $I_o = I_{o,max}$), $V_o = 1.2\text{ V}$

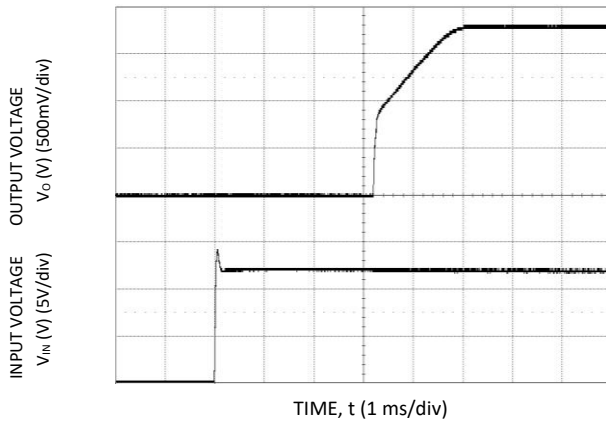

Figure 33. Start-up Using Input Voltage ($V_{IN} = 12\text{ V}$, $I_o = I_{o,max}$), $V_o = 1.8\text{ V}$

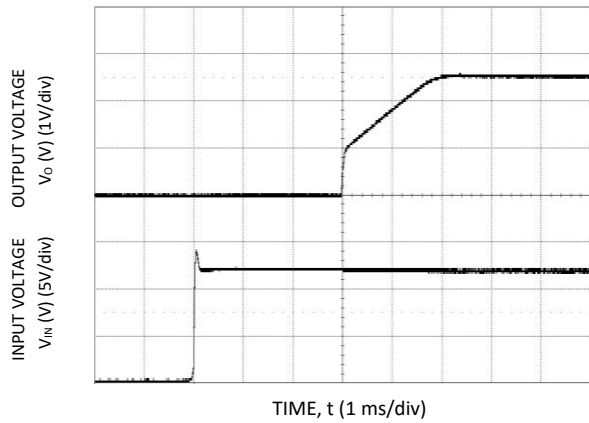

Figure 34. Start-up Using Input Voltage ($V_{IN} = 12\text{ V}$, $I_o = I_{o,max}$), $V_o = 2.5\text{ V}$

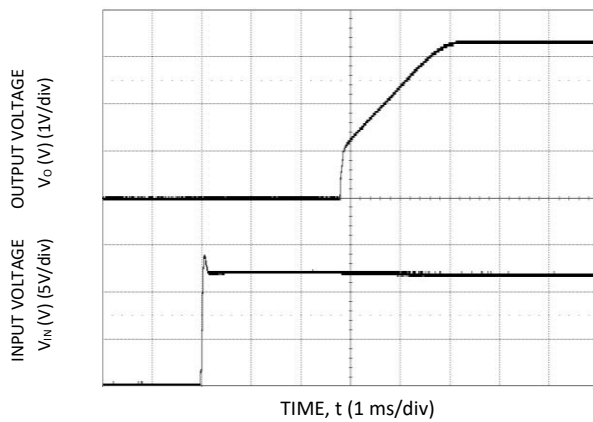

Figure 35. Start-up Using Input Voltage ($V_{IN} = 12\text{ V}$, $I_o = I_{o,max}$), $V_o = 3.3\text{ V}$

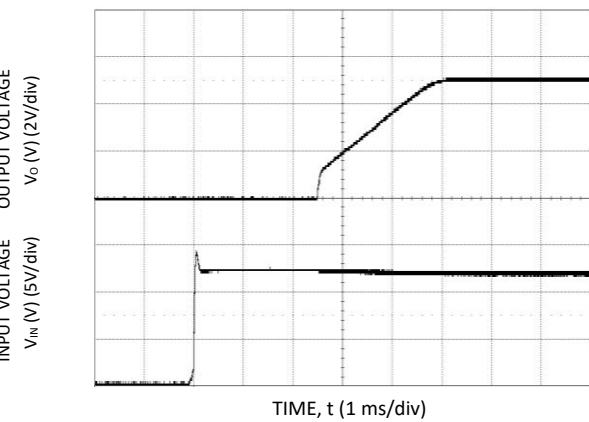
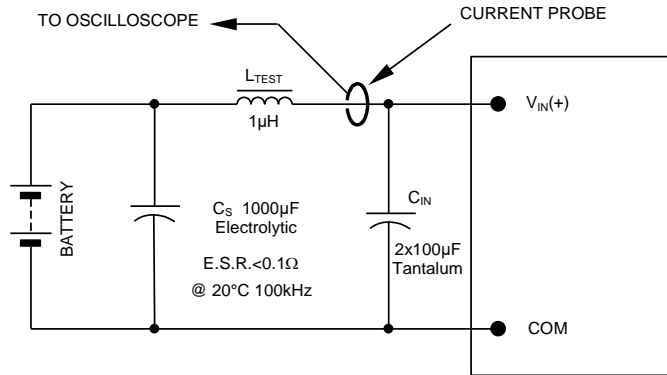

Figure 36. Start-up Using Input Voltage ($V_{IN} = 12\text{ V}$, $I_o = I_{o,max}$), $V_o = 5.0\text{ V}$

11. TEST CONFIGURATIONS

Input Reflected Ripple Current Test Setup.



NOTE: Measure input reflected ripple current with a simulated source inductance (L_{TEST}) of $1\mu H$. Capacitor C_S offsets possible battery impedance. Measure current as shown above.

Figure 37.

Output Ripple and Noise Test Setup

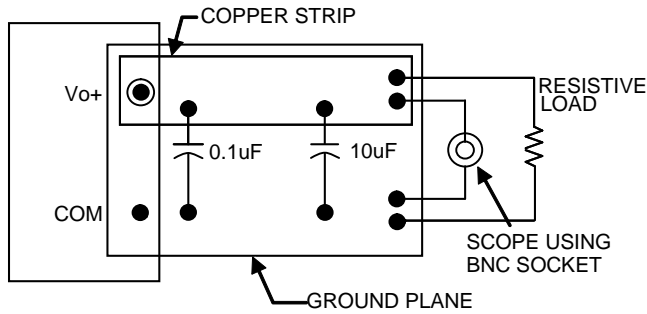

NOTE: All voltage measurements to be taken at the module terminals, as shown above. If sockets are used then Kelvin connections are required at the module terminals to avoid measurement errors due to socket contact resistance.

Figure 38.

Output Voltage and Efficiency Test Setup

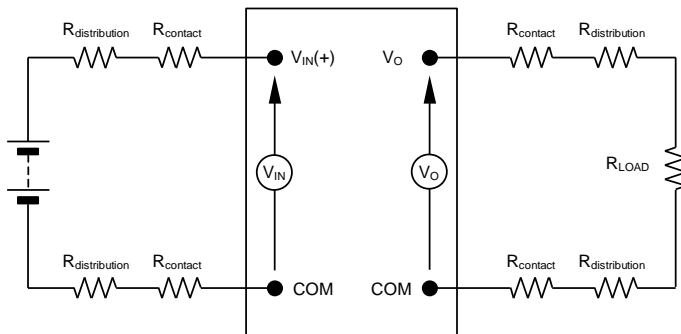

NOTE: All voltage measurements to be taken at the module terminals, as shown above. If sockets are used then Kelvin connections are required at the module terminals to avoid measurement errors due to socket contact resistance.

$$\text{Efficiency } \eta = \frac{V_O \cdot I_O}{V_{IN} \cdot I_{IN}} \times 100 \%$$

Figure 39.

12. INPUT FILTERING

The SLIN-12E1Ax should be connected to a low ac-impedance source. A highly inductive source can affect the stability of the module. Input capacitance must be placed directly adjacent to the input pin of the module, to minimize input ripple voltage and ensure module stability.

To minimize input voltage ripple, ceramic capacitors are recommended at the input of the module. The figure below shows the input ripple voltage for various output voltages at 12 A of load current with 1x22 μF or 2x22 μF ceramic capacitors and an input of 12 V.

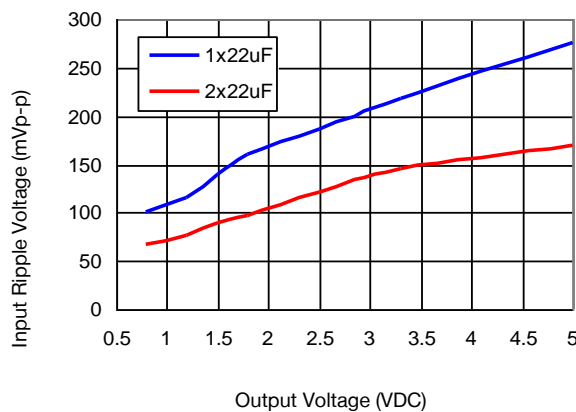

Figure 40.

Note: Input ripple voltage for various output voltages with 1x22 μF or 2x22 μF ceramic capacitors at the input (12 A load). Input voltage is 12 V.

13. OUTPUT FILTERING

The SLIN-12E1Ax modules are designed for low output ripple voltage and will meet the maximum output ripple specification with 0.1 μF ceramic and 10 μF ceramic capacitors at the output of the module. However, additional output filtering may be required by the system designer for several reasons. First, there may be a need to further reduce the output ripple and noise of the module. Second, the dynamic response characteristics may need to be customized to a particular load step change.

To reduce the output ripple and improve the dynamic response to a step load change, additional capacitance at the output can be used. Low ESR polymer and ceramic capacitors are recommended to improve the dynamic response of the module. The figure provides output ripple information for different external capacitance values at various V_o and for a load current of 12 A. For stable operation of the module, limit the capacitance to less than the maximum output capacitance as specified in the electrical specification table. Optimal performance of the module can be achieved by using the Tunable Loop™ feature described later in this data sheet.

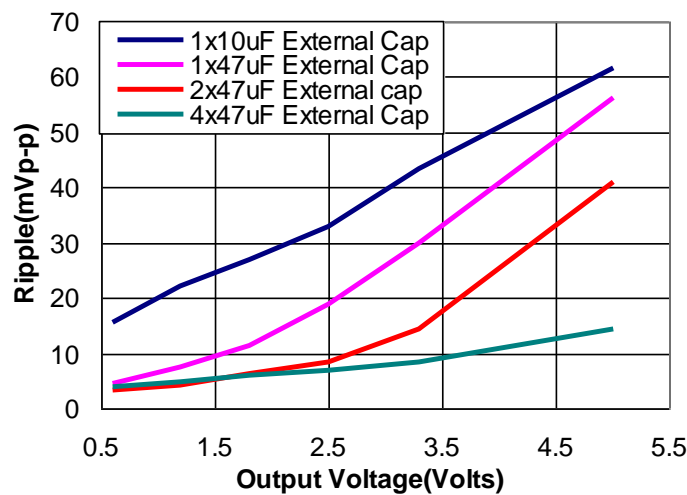

Figure 41.

Note: Output ripple voltage for various output voltages with external 1x10 μF , 1x47 μF , 2x47 μF or 4x47 μF ceramic capacitors at the output (12 A load). Input voltage is 12 V.

14. SAFETY CONSIDERATIONS

For safety agency approval the power module must be installed in compliance with the spacing and separation requirements of the end-use safety agency standards, i.e., UL/CSA 62368-1.

For the converter output to be considered meeting the requirements of safety extra-low voltage (SELV), the input must meet SELV requirements. The power module has extra-low voltage (ELV) outputs when all inputs are ELV.

The input to these units is to be provided with a fast-acting fuse with a maximum rating of 15 A in the positive input lead.

15. REMOTE ON/OFF

PARAMETER	DESCRIPTION	MIN	TYP	MAX	UNIT
Signal Low (Unit On)	Active Low	0	-	1	V
Signal High (Unit Off)	Active Low	2.0	-	V _{in,max}	V
Signal Low (Unit Off)	Active High	-	-	3.5	V
Signal High (Unit On)	Active High	V _{in} -1	-	V _{in,max}	V

The SLIN-12E1Ax modules feature an On/Off pin for remote On/Off operation. Two On/Off logic options are available. In the Positive Logic On/Off option, the module turns ON during a logic High on the On/Off pin and turns OFF during a logic Low. With the Negative Logic On/Off option, the module turns OFF during logic High and ON during logic Low. The On/Off signal is always referenced to ground. For either On/Off logic option, leaving the On/Off pin disconnected will turn the module ON when input voltage is present.

For positive logic modules, the circuit configuration for using the On/Off pin is shown in the figure below. When the external transistor Q1 is in the OFF state, the internal PWM Enable signal is pulled high through an internal 24.9 kΩ resistor and the external pullup resistor and the module is ON. When transistor Q1 is turned ON, the On/Off pin is pulled low and the module is OFF. A suggested value for R_{pullup} is 20 kΩ.

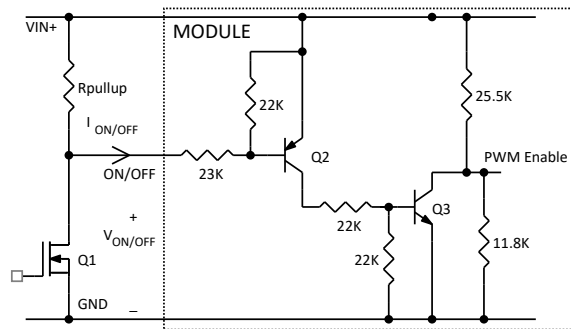

Figure 42. Circuit configuration for using positive On/Off logic

For negative logic On/Off modules, the circuit configuration is shown below. The On/Off pin should be pulled high with an external pull-up resistor (suggested value for the 4.5 V to 14 V input range is 20 kΩ). When transistor Q1 is in the OFF state, the On/Off pin is pulled high, internal transistor Q2 is turned ON and the module is OFF. To turn the module ON, Q1 is turned ON pulling the On/Off pin low, turning transistor Q2 OFF resulting in the PWM Enable pin going high and the module turning ON.

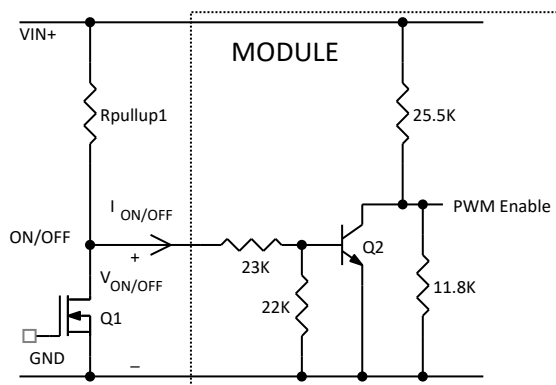

Figure 43. Circuit configuration for using negative On/Off logic

16. OVER CURRENT PROTECTION

To provide protection in a fault (output overload) condition, the unit is equipped with internal current limiting circuitry and can endure current limiting continuously. At the point of current limit inception, the unit enters hiccup mode. The unit operates normally once the output current is brought back into its specified range.

17. OVER TEMPERATURE PROTECTION

To provide protection in a fault condition, the unit is equipped with a thermal shutdown circuit. The unit will shut down if the over temperature threshold of 133°C is exceeded at the thermal reference point T_{ref} . The thermal shutdown is not intended as a guarantee that the unit will survive temperatures beyond its rating. Once the unit goes into thermal shutdown it will then wait to cool before attempting to restart.

18. INPUT UNDER-VOLTAGE LOCKOUT

At input voltages below the input under voltage lockout limit, the module operation is disabled. The module will begin to operate at an input voltage above the under-voltage lockout turn-on threshold.

19. OUTPUT VOLTAGE PROGRAMMING

The output voltage of the SLIN-12E1Ax modules can be programmed to any voltage from 0.69 VDC to 5.5 VDC by connecting a resistor between the Trim and GND pins of the module. Certain restrictions apply on the output voltage set point depending on the input voltage. These are shown below. The Limit curve shows that for output voltages of 0.9 V and lower, the input voltage must be lower than the maximum of 14 V. The Lower Limit curve shows that for output voltages of 3.3 V and higher, the input voltage needs to be larger than the minimum of 4.5 V.

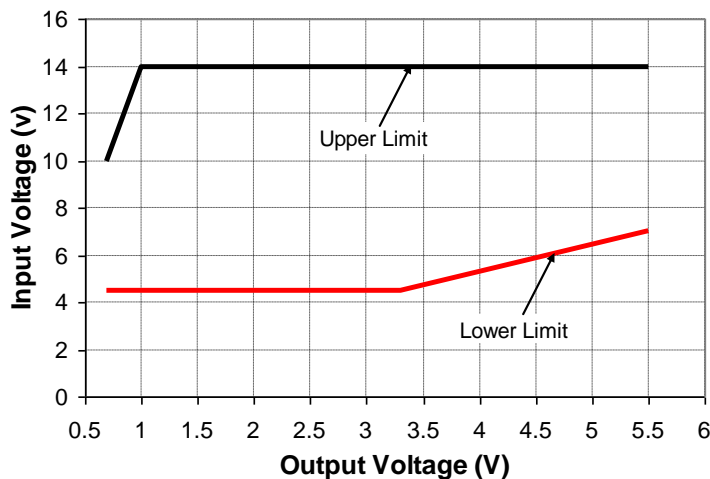

Figure 44. Output Voltage vs. Input Voltage Set Point Area plot showing limits where the output voltage can be set for different input voltages.

20. OUTPUT TRIM EQUATIONS

Without an external resistor between Trim and GND pins, the output of the module will be 0.69 VDC. To calculate the value of the trim resistor, Rtrim for a desired output voltage, use the following equation:

$$R_{trim} = \left[\frac{6.9}{(V_o - 0.69)} \right] k\Omega$$

Rtrim is the external resistor in KΩ
 Vo is the desired output voltage.

Table 1 provides Rtrim values required for some common output voltages.

VO, set (V)	Rtrim (KΩ)
0.7	690
1.0	22.26
1.2	13.53
1.5	8.519
1.8	6.216
2.5	3.812
3.3	2.644
5.0	1.601

Table 1.

By using a ±0.5% tolerance trim resistor with a TC of ±100 ppm, a set point tolerance of ±1.5% can be achieved as specified in the electrical specification.

21. REMOTE SENSE

The SLIN-12E1Ax power modules have a Remote Sense feature to minimize the effects of distribution losses by regulating the voltage between the VS+ and VS- pins. The voltage between the VS- and GND pins of the module must not drop below -0.2 V. If Remote Sense is being used, the voltage between VS+ and VS- cannot be more than 0.5 V larger than the voltage between VOUT and GND. Note that the output voltage of the module cannot exceed the specified maximum value. When the Remote Sense feature is not being used, connect the VS+ pin to the VOUT pin and the VS- pin to the GND pin.

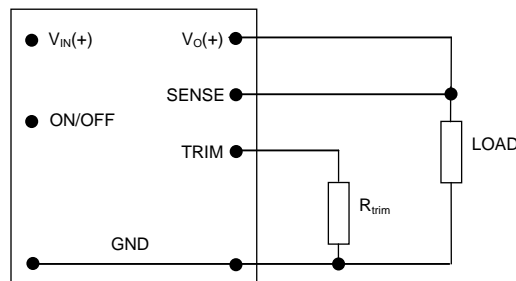

Figure 45. Circuit configuration for programming output voltage using an external resistor

22. STRATUP INTO PRE-BIASED OUTPUT

The SLIN-12E1Ax modules can start into a pre-biased output as long as the pre-bias voltage is 0.5 V less than the set output voltage. Note that pre-bias operation is not supported when output voltage sequencing is used.

23. VOLTAGE MARGINING

Output voltage margining can be implemented in the SLIN-12E1Ax modules by connecting a resistor, $R_{margin-up}$, from the Trim pin to the ground pin for margining-up the output voltage and by connecting a resistor, $R_{margin-down}$, from the Trim pin to output pin for margining-down.

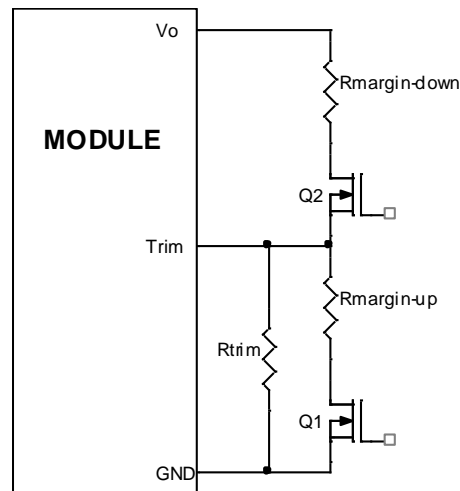

Figure 46. Circuit Configuration for margining Output voltage

24. MONOTONIC START-UP AND SHUTDOWN

The SLIN-12E1Ax modules have monotonic start-up and shutdown behavior for any combination of rated input voltage, output current and operating temperature range.

25. OUTPUT VOLTAGE SEQUENCING

The SLIN-12E1Ax modules include a sequencing feature that enables users to implement various types of output voltage sequencing in their applications. This is accomplished via an additional sequencing pin. When not using the sequencing feature, either tie the SEQ pin to VIN or leave it unconnected.

When an analog voltage is applied to the SEQ pin, the output voltage tracks this voltage until the output reaches the set-point voltage. The final value of the SEQ voltage must be set higher than the set-point voltage of the module. The output voltage follows the voltage on the SEQ pin on a one-to-one volt basis. By connecting multiple modules together, multiple modules can track their output voltages to the voltage applied on the SEQ pin.

For proper voltage sequencing, first, input voltage is applied to the module. The On/Off pin of the module is left unconnected (or tied to GND for negative logic modules or tied to VIN for positive logic modules) so that the module is ON by default.

After applying input voltage to the module, a minimum 10msec delay is required before applying voltage on the SEQ pin. During this time, a voltage of 50 mV (± 20 mV) is maintained on the SEQ pin.

This can be done by applying the sequencing voltage through a resistor R1 connected in series with the SEQ pin. This delay gives the module enough time to complete its internal power-up soft-start cycle. During the delay time, the SEQ pin should be held close to ground (nominally $50\text{mV} \pm 20\text{mV}$). This is required to keep the internal op-amp out of saturation thus preventing output overshoot during the start of the sequencing ramp. By selecting resistor R1 according to the following equation:

$$R1 = \frac{24950}{V_{IN} - 0.05} \text{ Ohms}$$

The voltage at the sequencing pin will be 50 mV when the sequencing signal is at zero.

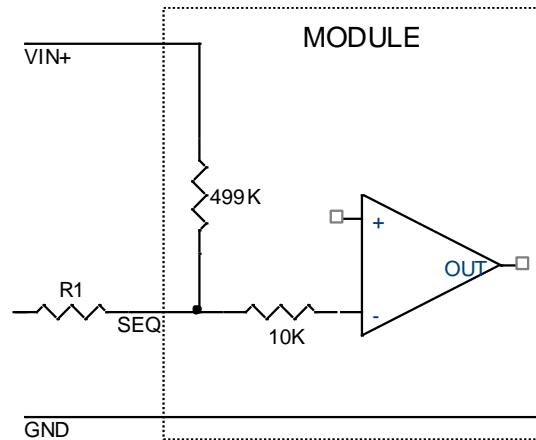

Figure 47. Circuit showing connection of the sequencing signal to the SEQ pin

After the 10msec delay, an analog voltage is applied to the SEQ pin and the output voltage of the module will track this voltage on a one-to-one volt basis until the output reaches the set-point voltage. To initiate simultaneous shutdown of the modules, the SEQ voltage is lowered in a controlled manner. The output voltage of the modules tracks the voltages below their set-point voltages on a one-to-one basis. A valid input voltage must be maintained until the tracking and output voltages reach ground potential.

When using the sequencing feature to control start-up of the module, pre-bias immunity during start-up is disabled. The pre-bias immunity feature of the module relies on the module being in the diode-mode during start-up. When using the sequencing feature, modules go through an internal set-up time of 10msec, and will be in synchronous rectification mode when the voltage at the SEQ pin is applied. This will result in the module sinking current if a pre-bias voltage is present at the output of the module. When pre-bias immunity during start-up is required, the sequencing feature must be disabled. For additional guidelines on using the sequencing feature please contact the Bel Power technical representative for additional information.

26. SYNCHRONIZATION

The SLIN-12E1Ax modules can be synchronized using an external signal. Details of the SYNC signal are provided in the Electrical Specifications table. If the synchronization function is not being used, leave the SYNC pin floating.

27. POWER GOOD

The SLIN-12E1Ax modules provide a Power Good (PGOOD) signal that is implemented with an open-drain output to indicate that the output voltage is within the regulation limits of the power module. The PGOOD signal will be de-asserted to a low state if any condition such as over temperature, over current or loss of regulation occurs that would result in the output voltage going $\pm 11\%$ outside the set point value. The PGOOD terminal should be connected through a pull-up resistor (suggested value 100 k Ω) to a source of 6 VDC or less.

28. TUNABLE LOOP™

The SLIN-12E1Ax modules have a new feature that optimizes transient response of the module called Tunable Loop™.

External capacitors are usually added to the output of the module for two reasons: to reduce output ripple and noise and to reduce output voltage deviations from the steady-state value in the presence of dynamic load current changes. Adding external capacitance however affects the voltage control loop of the module, typically causing the loop to slow down with sluggish response. Larger values of external capacitance could also cause the module to become unstable.

The Tunable Loop™ allows the user to externally adjust the voltage control loop to match the filter network connected to the output of the module. The Tunable Loop™ is implemented by connecting a series R-C between the SENSE and TRIM pins of the module, as shown below. This R-C allows the user to externally adjust the voltage loop feedback compensation of the module.

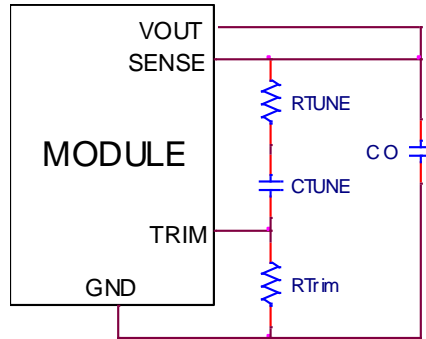

Figure 48. Circuit diagram showing connection of R_{TUNE} and C_{TUNE} to tune the control loop of the module

Recommended values of R_{TUNE} and C_{TUNE} for different output capacitor combinations are given in Tables 2 and 3. Table 2 shows the recommended values of R_{TUNE} and C_{TUNE} for different values of ceramic output capacitors up to 940 μF that might be needed for an application to meet output ripple and noise requirements. Selecting R_{TUNE} and C_{TUNE} according to Table 2 will ensure stable operation of the module.

In applications with tight output voltage limits in the presence of dynamic current loading, additional output capacitance will be required. Table 3 lists recommended values of R_{TUNE} and C_{TUNE} in order to meet 2% output voltage deviation limits for some common output voltages in the presence of a 6 A to 12 A step change (50% of full load), with an input voltage of 12 V.

C_o	1x 47 μF	2x 47 μF	4x 47 μF	10x 47 μF	20x 47 μF
R_{TUNE}	470 Ω	270 Ω	150 Ω	150 Ω	150 Ω
C_{TUNE}	1000 pF	3300 pF	4700 pF	8200 pF	12 nF

Table 2. General recommended values of R_{TUNE} and C_{TUNE} for $V_{in} = 12\text{ V}$ and various external ceramic capacitor combinations.

V_o	5 V	3.3 V	2.5 V	1.8 V	1.2 V	0.69 V
C_o	4x 47 μF	1x 47 μF + 330 μF Polymer	2x 47 μF + 330 μF Polymer	6x 47 μF + 330 μF Polymer	6x 47 μF + 2x 330 μF Polymer	4x 47 μF + 6x 330 μF Polymer
R_{TUNE}	270 Ω	220 Ω	220 Ω	220 Ω	150 Ω	150 Ω
C_{TUNE}	3300 pF	4700 pF	6800 pF	18 nF	33 nF	100 nF
ΔV	91 mV	60 mV	47 mV	35 mV	23 mV	12 mV

Table 3. Recommended values of R_{TUNE} and C_{TUNE} to obtain transient deviation of $\leq 2\%$ of V_{out} for a 6 A step load with $V_{in} = 12\text{ V}$

29. THERMAL CONSIDERATIONS

Power modules operate in a variety of thermal environments; however, sufficient cooling should always be provided to help ensure reliable operation.

Considerations include ambient temperature, airflow, module power dissipation, and the need for increased reliability. A reduction in the operating temperature of the module will result in an increase in reliability. The thermal data presented here is based on physical measurements taken in a wind tunnel. The test set-up is shown below.

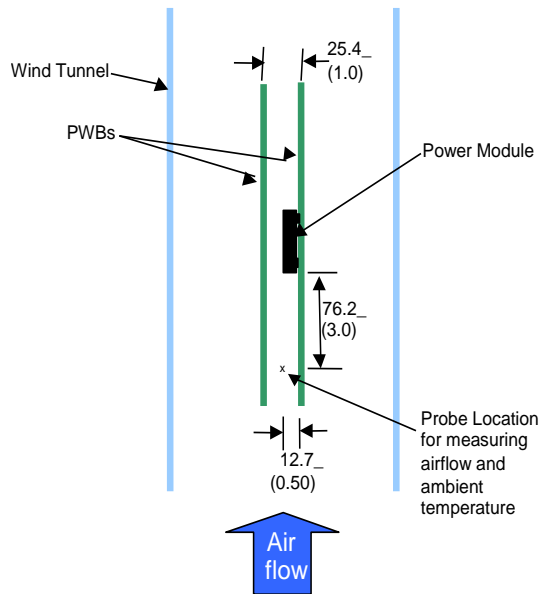

Figure 49. Thermal Test Setup

The preferred airflow direction and the thermal reference points, T_{ref} , used in the specifications are also shown below. For reliable operation the temperatures at these points should not exceed 125 °C. The output power of the module should not exceed the rated power of the module ($V_{o,set} \times I_{o,max}$). The derating data applies to airflow in either direction of the module’s short axis.

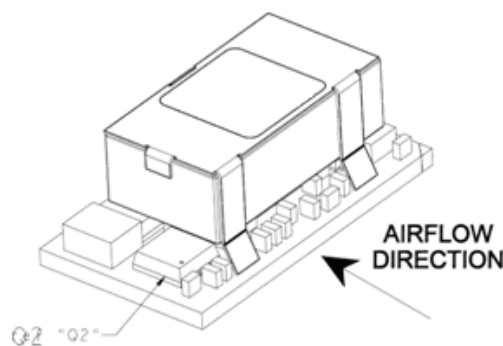

Figure 50. Preferred airflow direction and location of hot spot of the module (T_{ref}).

30. EXAMPLE APPLICATION CIRCUIT

Requirements:

V _{in} :	12 V
V _{out} :	1.8 V
I _{out} :	9.0 A max., worst case load transient is from 6 A to 9 A
ΔV _{out} :	1.5% of V _{out} (27 mV) for worst case load transient
V _{in} , ripple	1.5% of V _{in} (180 mV, p-p)

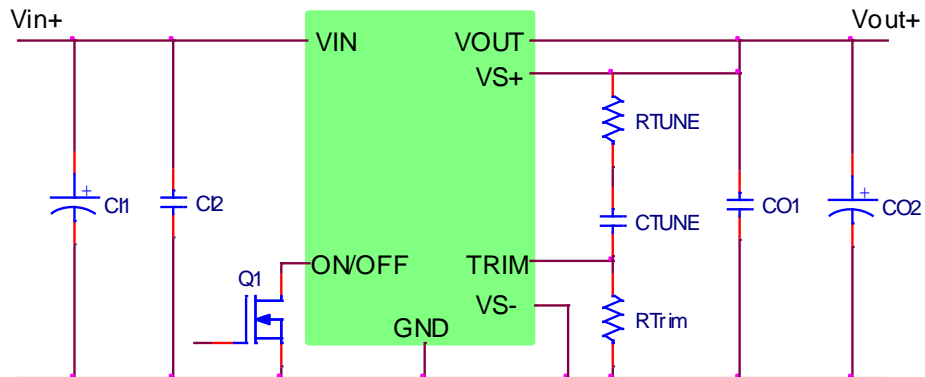

Figure 51.

C1	22 μ F/16 V ceramic capacitor (e.g. Murata GRM32ER61C226KE20)
C2	100 μ F/16 V bulk electrolytic
CO1	6 x 47 μ F/6.3 V ceramic capacitor (e.g. Murata GRM31CR60J476ME19)
CO2	330 μ F/6.3 V Polymer (e.g. Sanyo, Poscap)
Ctune	15 nF ceramic capacitor (can be 1206, 0805 or 0603 size)
Rtune	150 Ω SMT resistor (can be 1206, 0805 or 0603 size)
Rtrim	6.19 k Ω SMT resistor (can be 1206, 0805 or 0603 size, recommended tolerance of 0.1%)

31. MECHANICAL DIMENSIONS
OUTLINE

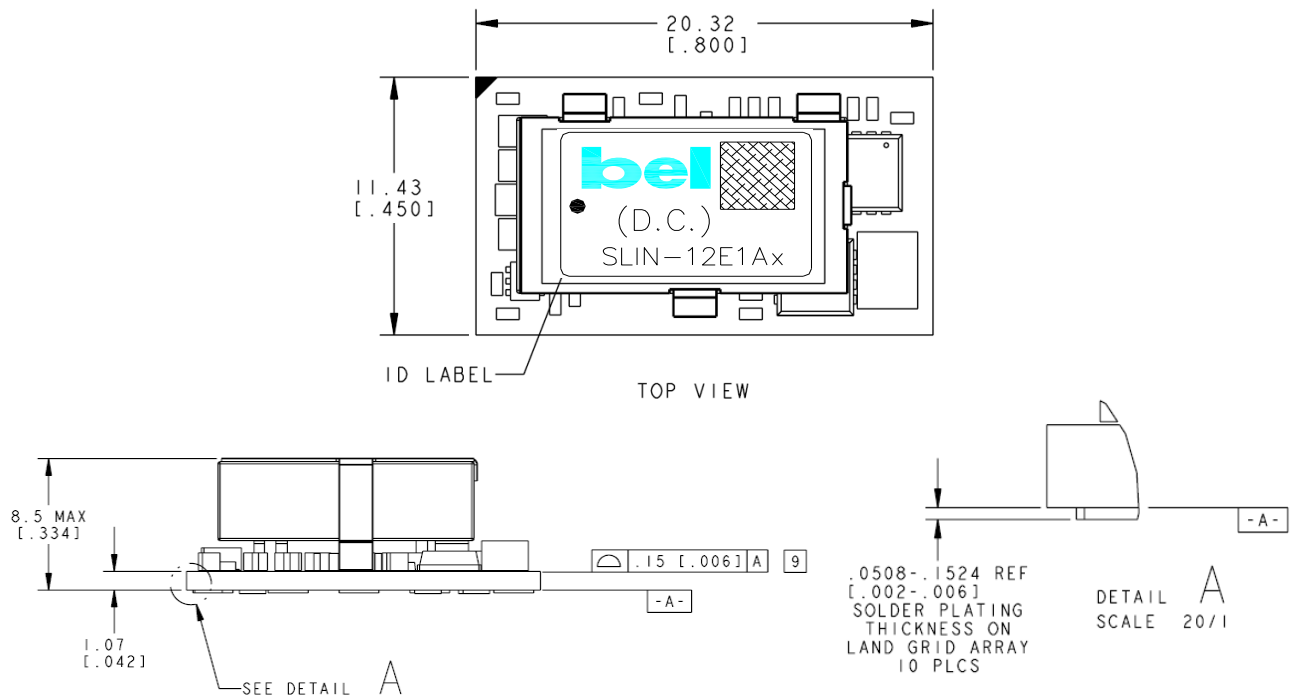

Figure 52. Outline

Dimensions are in millimeter [inch].
Tolerances: x.x ± 0.5 mm [0.02 inch] [unless otherwise indicated]
x.xx ± 0.25 mm [0.010 inch]

Note: This module is recommended and compatible with Pb-Free Reflow Soldering and must be soldered using a reflow profile with a peak temperature of no more than 260 °C for less than 5 seconds.

RECOMMENDED PAD LAYOUT

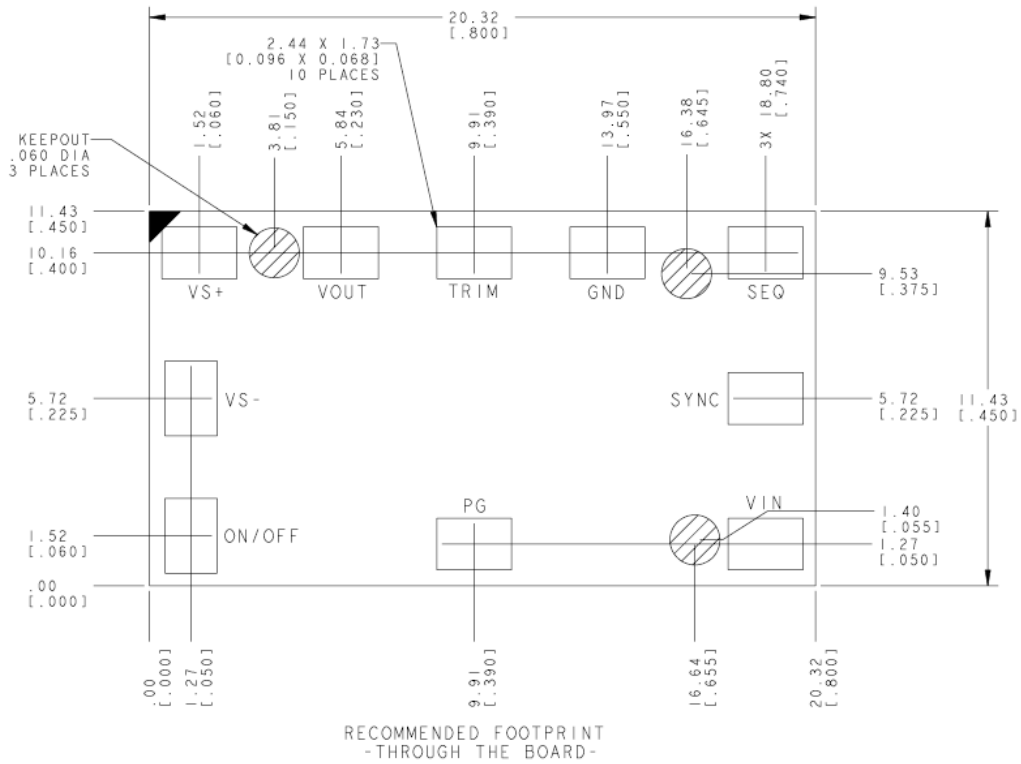

Figure 53. Recommended pad layout

PIN	FUNCTION	PIN	FUNCTION
1	ON/OFF	6	VOUT
2	VIN	7	VS+
3	SEQ	8	VS-
4	GND	9	PG
5	TRIM	10	SYNC

32. PACKAGING DETAILS

The SLIN-12E1Ax modules are supplied in tape & reel as standard.
All Dimensions are in millimeter [inch].

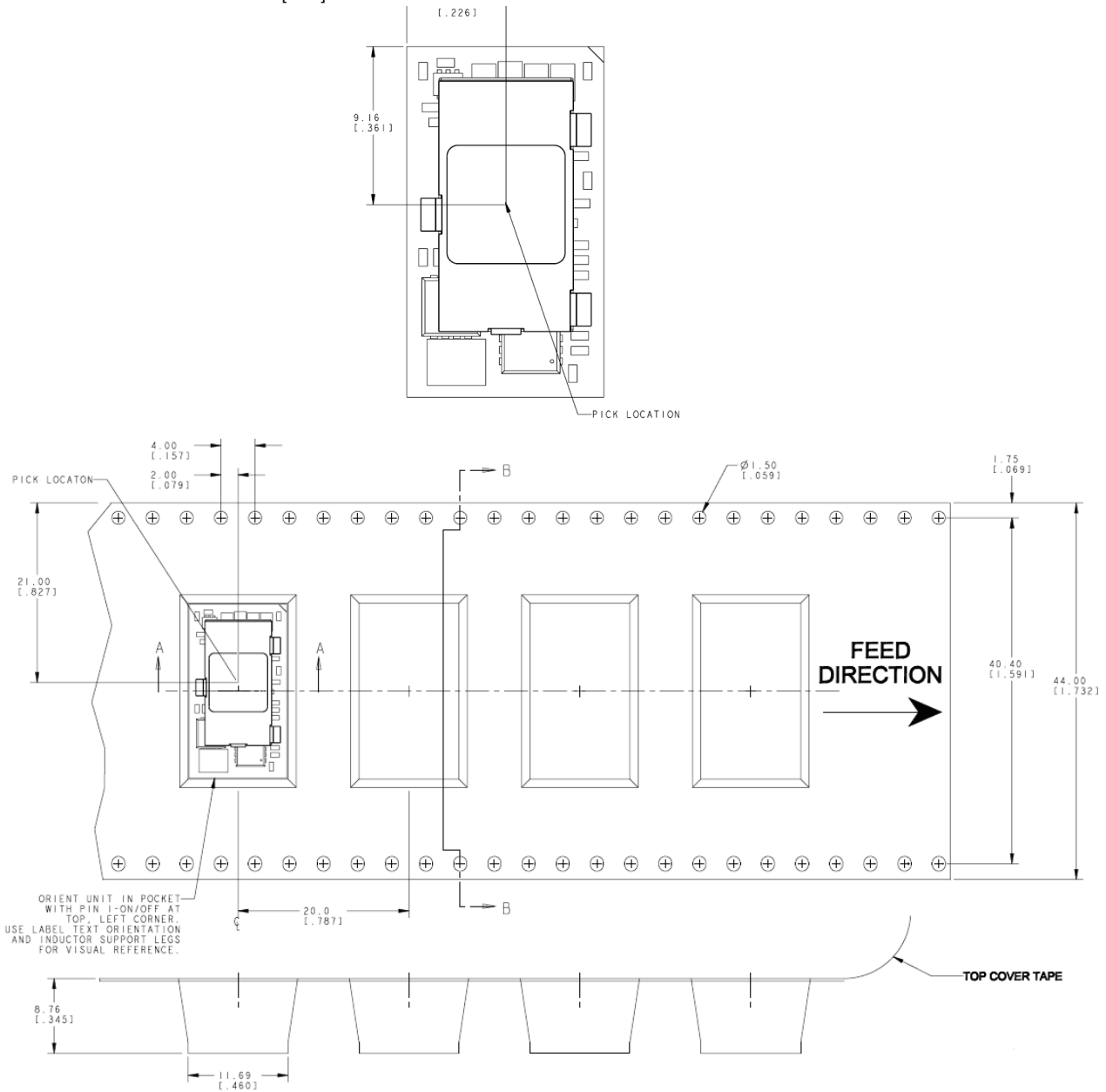

Figure 54.

Reel Dimensions:
 Outside Dimensions: 330.2 mm [13.00 inch]
 Inside Dimensions: 177.8 mm [7.00 inch]
 Tape Width: 44.00 mm [1.732 inch]



Asia-Pacific
+86 755 298 85888

Europe, Middle East
+353 61 49 8941

North America
+1 866 513 2839

33. SURFACE MOUNT INFORMATION

PICK AND PLACE

The SLIN-12E1Ax modules use an open frame construction and are designed for a fully automated assembly process. The modules are fitted with a label designed to provide a large surface area for pick and place operations. The label meets all the requirements for surface mount processing, as well as safety standards, and is able to withstand reflow temperatures of up to 300°C. The label also carries product information such as part number and serial number.

NOZZLE RECOMMENDATIONS

The module weight has been kept to a minimum by using open frame construction. Variables such as nozzle size, tip style, vacuum pressure and placement speed should be considered to optimize this process. The minimum recommended inside nozzle diameter for reliable operation is 3mm. The maximum nozzle outer diameter, which will safely fit within the allowable component spacing, is 7 mm.

LEAD FREE SOLDERING

The SLIN-12E1Ax modules are lead-free (Pb-free) and RoHS compliant and fully compatible in a Pb-free soldering process. Failure to observe the instructions below may result in the failure of or cause damage to the modules and can adversely affect long-term reliability.

PB-FREE REFLOW PROFILE

Power Systems will comply with J-STD-020 Rev. C (Moisture/Reflow Sensitivity Classification for Nonhermetic Solid State Surface Mount Devices) for both Pb-free solder profiles and MSL classification procedures. This standard provides a recommended forced-air-convection reflow profile based on the volume and thickness of the package. The suggested Pb-free solder paste is Sn/Ag/Cu (SAC). The recommended linear reflow profile using Sn/Ag/Cu solder is shown in the figure below. Soldering outside of the recommended profile requires testing to verify results and performance.

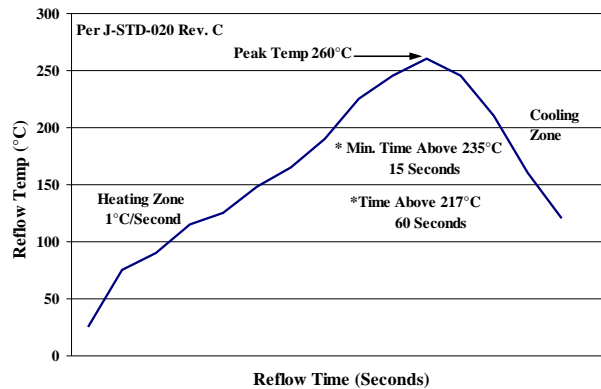

Figure 55. Recommended linear reflow profile using Sn/Ag/Cu solder.

MSL RATING

The SLIN-12E1Ax modules have a MSL rating of 2A.

STORAGE AND HANDLING

The recommended storage environment and handling procedures for moisture-sensitive surface mount packages is detailed in J-STD-033 Rev. A (Handling, Packing, Shipping and Use of Moisture/Reflow Sensitive Surface Mount Devices). Moisture barrier bags (MBB) with desiccant are required for MSL ratings of 2 or greater. These sealed packages should not be broken until time of use. Once the original package is broken, the floor life of the product at conditions of $\leq 30^{\circ}\text{C}$ and 60% relative humidity varies according to the MSL rating (see J-STD-033A). The shelf life for dry packed SMT packages will be a minimum of 12 months from the bag seal date, when stored at the following conditions: $< 40^{\circ}\text{C}$, $< 90\%$ relative humidity.

POST SOLDER CLEANING AND DRYING CONSIDERATIONS

Post solder cleaning is usually the final circuit board assembly process prior to electrical board testing. The result of inadequate cleaning and drying can affect both the reliability of a power module and the testability of the finished circuit board assembly.

34. REVISION HISTORY

DATE	REVISION	CHANGES DETAIL	APPROVAL
2009-06-01	A	First release	T. Bubriski
2009-06-25	B	Section "Surface Mount Information" added.	T. Bubriski
2009-09-01	C	Tunable Loop™ logo added.	T. Bubriski
2009-10-08	D	Updated Startup Time waveforms on page 10.	T. Bubriski
2009-11-05	E	Corrected I/P Reflected Ripple Current.	T. Bubriski
2010-01-20	F	Updated Remote ON/OFF section on page 14.	T. Bubriski
2010-11-05	G	Updated Thermal Derating Curves on page 6.	T. Bubriski
2010-12-02	H	Updated Output Voltage Limit for PGOOD and MTBF on page 4 and Power Good section on page 19.	T. Bubriski
2015-07-29	I	Update UL in features, update part Selection, part number explanation, absolute maximum ratings, MSL rating, add label in mechanical outline.	XF.Jiang
2021-08-17	AJ	Update to new form. Add object ID. Update safety certificate.	XF.Jiang

For more information on these products consult: tech.support@psbel.com

NUCLEAR AND MEDICAL APPLICATIONS - Products are not designed or intended for use as critical components in life support systems, equipment used in hazardous environments, or nuclear control systems.

TECHNICAL REVISIONS - The appearance of products, including safety agency certifications pictured on labels, may change depending on the date manufactured. Specifications are subject to change without notice.



tech.support@psbel.com
belfuse.com/power-solutions

Looking for pricing, stock, or lifecycle information?

Click below to explore more details on WIN SOURCE:

- ⊖ [View SLIN-12E1ALG on WIN SOURCE](#)
- ⊖ [Bel Power Solutions Information](#)

Optimize Your Supply Chain with WIN SOURCE Solutions

- ✓ Global Sourcing Solution
- ✓ Obsolete Management
- ✓ Cost Control Management
- ✓ Shortage Management
- ✓ Alternative Solution
- ✓ Excess Inventory Management