



**THE DATASHEET OF  
CY24713SXCT**



# Set-top Box Clock Generator with VCXO

## Features

- Integrated phase-locked loop (PLL)
- Low-jitter, high-accuracy outputs
- VCXO with analog adjust
- 3.3V Operation
- 8-pin SOIC

## Benefits

- High-performance PLL tailored for Set Top Box applications
- Meets critical timing requirements in complex system designs
- Large  $\pm 150$ -ppm range, better linearity
- Meet industry standard voltage platforms
- Industry standard packaging saves on board space

Part Number	Outputs	Input Frequency Range	Output Frequencies
CY24713	3	27-MHz pullable crystal input per Cypress specification	4.9152 MHz, 13.5 MHz, 27 MHz

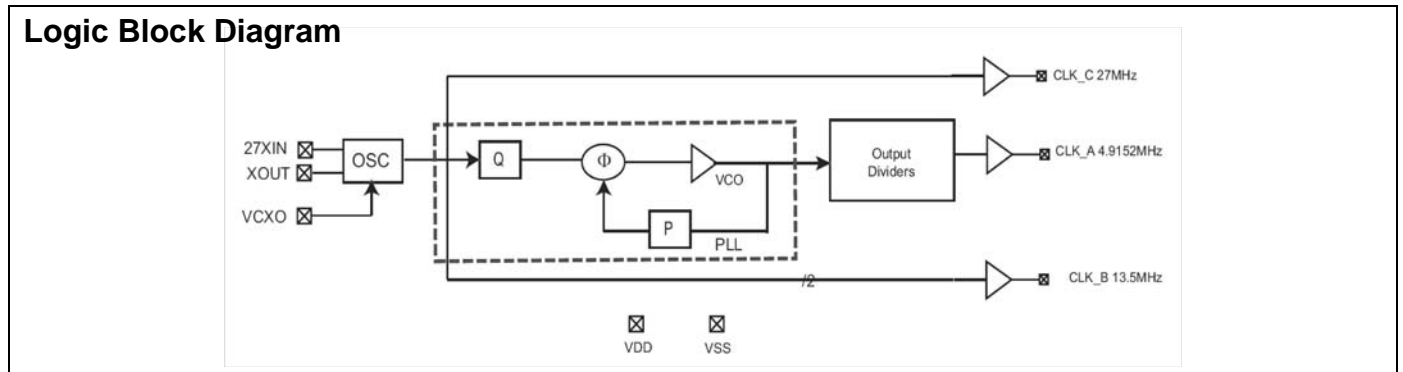

## Pin Configuration

Figure 1. CY24713, 8-Pin SOIC

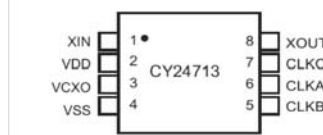

Table 1. Pin Definition

Name	Number	Description
XIN	1	Reference Crystal Input
VDD	2	3.3V Voltage Supply
VCXO	3	Input Analog Control for VCXO
VSS	4	Ground
CLK_B	5	13.5-MHz Clock Output
CLK_A	6	4.9152-MHz Clock Output
CLK_C	7	27-MHz Clock Output
XOUT <sup>[1]</sup>	8	Reference Crystal Output

### Note

1. Float X<sub>OUT</sub> if X<sub>IN</sub> is externally driven.

## Absolute Maximum Conditions

Parameter	Description	Min	Max	Unit
V <sub>DD</sub>	Supply Voltage	-0.5	7.0	V
T <sub>S</sub>	Storage Temperature <sup>[2]</sup>	-65	125	°C
T <sub>J</sub>	Junction Temperature	-	125	°C
	Digital Inputs	V <sub>SS</sub> - 0.3	V <sub>DD</sub> + 0.3	V
	Digital Outputs referred to V <sub>DD</sub>	V <sub>SS</sub> - 0.3	V <sub>DD</sub> + 0.3	V
	Electrostatic Discharge	-	2000	V
	Analog Input	-0.5	7.0	V

## Pullable Crystal Specifications

Parameter	Description	Condition	Min	Typ.	Max	Unit
F <sub>NOM</sub>	Nominal crystal frequency	Parallel resonance, fundamental mode, AT cut	-	27	-	MHz
C <sub>LNOM</sub>	Nominal load capacitance		-	14	-	pF
R <sub>1</sub>	Equivalent series resistance (ESR)	Fundamental mode	-	-	25	Ω
R <sub>3</sub> /R <sub>1</sub>	Ratio of third overtone mode ESR to fundamental mode ESR	Ratio used because typical R <sub>1</sub> values are much less than the maximum spec.	3	-	-	
DL	Crystal drive level	No external series resistor assumed	-	0.5	2.0	mW
F <sub>3SEPHI</sub>	Third overtone separation from 3*F <sub>NOM</sub>	High side	300	-	-	ppm
F <sub>3SEPLO</sub>	Third overtone separation from 3*F <sub>NOM</sub>	Low side	-	-	-150	ppm
C <sub>0</sub>	Crystal shunt capacitance		-	-	7	pF
C <sub>0</sub> /C <sub>1</sub>	Ratio of shunt to motional capacitance		180	-	250	
C <sub>1</sub>	Crystal motional capacitance		14.4	18	21.6	pF

## Recommended Operating Conditions

Parameter	Description	Min	Typ.	Max	Unit
V <sub>DD</sub>	Operating Voltage	3.135	3.3	3.465	V
T <sub>A</sub>	Ambient Temperature	0	-	70	°C
C <sub>LOAD</sub>	Max. Load Capacitance	-	-	15	pF
t <sub>PU</sub>	Power up time for all VDDs to reach minimum specified voltage (power ramps must be monotonic)	0.05	-	500	ms

## DC Electrical Characteristics

Parameter	Description	Conditions	Min	Typ.	Max	Unit
I <sub>OH</sub>	Output High Current	V <sub>OH</sub> = V <sub>DD</sub> - 0.5, V <sub>DD</sub> = 3.3V	12	24	-	mA
I <sub>OL</sub>	Output Low Current	V <sub>OL</sub> = 0.5, V <sub>DD</sub> = 3.3V	12	24	-	mA
C <sub>IN</sub>	Input Capacitance		-	-	7	pF
I <sub>Iz</sub>	Input Leakage Current		-	5	-	μA
f <sub>ΔXO</sub>	VCXO pullability range		±150	-	-	ppm
V <sub>VCXO</sub>	VCXO input range		0	-	V <sub>DD</sub>	V
I <sub>VDD</sub>	Supply Current		-	25	30	mA

**Note**

2. Rated for 10 years

**AC Electrical Characteristics** ( $V_{DD} = 3.3V$ )

Parameter <sup>[3]</sup>	Description	Conditions	Min	Typ.	Max	Unit
DC	Output Duty Cycle	Duty Cycle is defined in Figure 3 50% of $V_{DD}$	45	50	55	%
$ER_0$	Rising Edge Rate	Output Clock Edge Rate, Measured from 20% to 80% of $V_{DD}$ , $C_{LOAD} = 15\text{ pF}$ Figure 4.	0.8	1.4	–	V/ns
$EF_1$	Falling Edge Rate	Output Clock Edge Rate, Measured from 80% to 20% of $V_{DD}$ , $C_{LOAD} = 15\text{ pF}$ Figure 4.	0.8	1.4	–	V/ns
$t_9$	Clock Jitter	Peak-Peak period jitter maximum absolute jitter	–	200	250	ps
$t_{10}$	PLL Lock Time		–	–	3	ms

Figure 2. Test Circuit

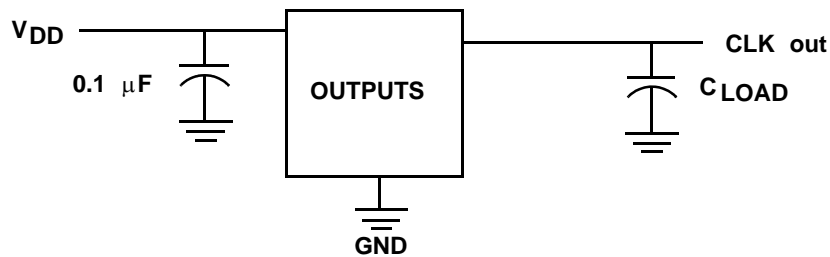

Figure 3. Duty Cycle Definition;  $DC = t_2/t_1$

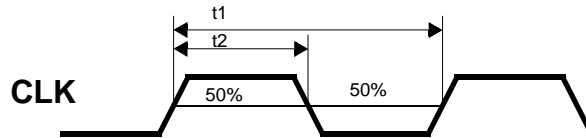
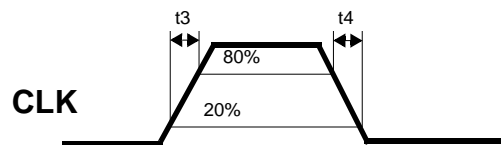

Figure 4. Rise and Fall Time Definitions:  $ER = 0.6 \times V_{DD}/t_3$ ,  $EF = 0.6 \times V_{DD}/t_4$



**Note**  
3. Not 100% tested

### Ordering Information

Ordering Code	Package Type	Operating Range	Operating Voltage
CY24713SC <sup>[4]</sup>	8-pin SOIC	Commercial	3.3V
CY24713SCT <sup>[4]</sup>	8-pin SOIC	Commercial	3.3V
<b>Pb-free</b>			
CY24713SXC <sup>[4]</sup>	8-pin SOIC	Commercial	3.3V
CY24713SXCT <sup>[4]</sup>	8-pin SOIC-Tape and Reel	Commercial	3.3V
CY24713KSXC	8-pin SOIC	Commercial	3.3V
CY24713KSXCT	8-pin SOIC-Tape and Reel	Commercial	3.3V

### Package Diagram

Figure 5. 8-Lead (150-Mil) SOIC S8

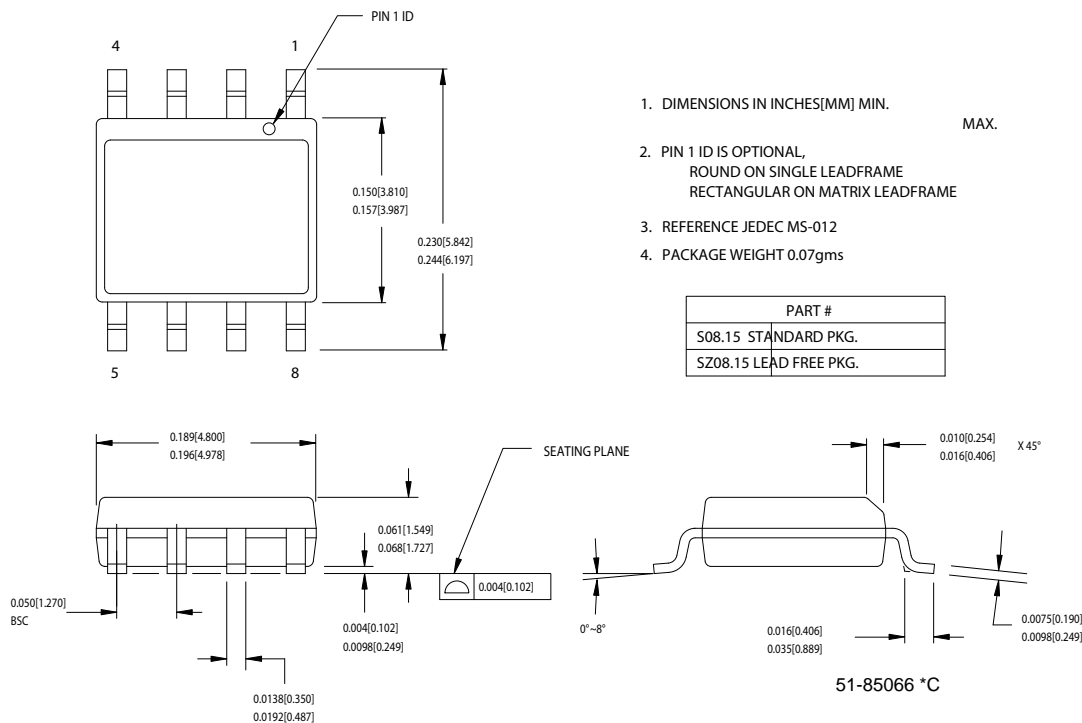

**Note**

4. Not recommended for new designs.

## Document History Page

Document Title: CY24713 Set-top Box Clock Generator with VCXO Document Number: 38-07396				
REV.	ECN No.	Orig. of Change	Submission Date	Description of Change
**	333175	RGL	See ECN	New Data Sheet
*A	2440886	AESA	See ECN	Updated template. Added Note "Not recommended for new designs." Added part number CY24713KSXC, and CY24713KSXCT in ordering information table. Replaced Lead-Free with Pb-Free.

## Sales, Solutions, and Legal Information

### Worldwide Sales and Design Support

Cypress maintains a worldwide network of offices, solution centers, manufacturer's representatives, and distributors. To find the office closest to you, visit us at [cypress.com/sales](http://cypress.com/sales).

#### Products

PSoC	<a href="http://psoc.cypress.com">psoc.cypress.com</a>
Clocks & Buffers	<a href="http://clocks.cypress.com">clocks.cypress.com</a>
Wireless	<a href="http://wireless.cypress.com">wireless.cypress.com</a>
Memories	<a href="http://memory.cypress.com">memory.cypress.com</a>
Image Sensors	<a href="http://image.cypress.com">image.cypress.com</a>

#### PSoC Solutions

General	<a href="http://psoc.cypress.com/solutions">psoc.cypress.com/solutions</a>
Low Power/Low Voltage	<a href="http://psoc.cypress.com/low-power">psoc.cypress.com/low-power</a>
Precision Analog	<a href="http://psoc.cypress.com/precision-analog">psoc.cypress.com/precision-analog</a>
LCD Drive	<a href="http://psoc.cypress.com/lcd-drive">psoc.cypress.com/lcd-drive</a>
CAN 2.0b	<a href="http://psoc.cypress.com/can">psoc.cypress.com/can</a>
USB	<a href="http://psoc.cypress.com/usb">psoc.cypress.com/usb</a>

© Cypress Semiconductor Corporation, 2005-2008. The information contained herein is subject to change without notice. Cypress Semiconductor Corporation assumes no responsibility for the use of any circuitry other than circuitry embodied in a Cypress product. Nor does it convey or imply any license under patent or other rights. Cypress products are not warranted nor intended to be used for medical, life support, life saving, critical control or safety applications, unless pursuant to an express written agreement with Cypress. Furthermore, Cypress does not authorize its products for use as critical components in life-support systems where a malfunction or failure may reasonably be expected to result in significant injury to the user. The inclusion of Cypress products in life-support systems application implies that the manufacturer assumes all risk of such use and in doing so indemnifies Cypress against all charges.



Any Source Code (software and/or firmware) is owned by Cypress Semiconductor Corporation (Cypress) and is protected by and subject to worldwide patent protection (United States and foreign), United States copyright laws and international treaty provisions. Cypress hereby grants to licensee a personal, non-exclusive, non-transferable license to copy, use, modify, create derivative works of, and compile the Cypress Source Code and derivative works for the sole purpose of creating custom software and/or firmware in support of licensee product to be used only in conjunction with a Cypress integrated circuit as specified in the applicable agreement. Any reproduction, modification, translation, compilation, or representation of this Source Code except as specified above is prohibited without the express written permission of Cypress.

Disclaimer: CYPRESS MAKES NO WARRANTY OF ANY KIND, EXPRESS OR IMPLIED, WITH REGARD TO THIS MATERIAL, INCLUDING, BUT NOT LIMITED TO, THE IMPLIED WARRANTIES OF MERCHANTABILITY AND FITNESS FOR A PARTICULAR PURPOSE. Cypress reserves the right to make changes without further notice to the materials described herein. Cypress does not assume any liability arising out of the application or use of any product or circuit described herein. Cypress does not authorize its products for use as critical components in life-support systems where a malfunction or failure may reasonably be expected to result in significant injury to the user. The inclusion of Cypress' product in a life-support systems application implies that the manufacturer assumes all risk of such use and in doing so indemnifies Cypress against all charges.

Use may be limited by and subject to the applicable Cypress software license agreement.

## Looking for pricing, stock, or lifecycle information?

Click below to explore more details on WIN SOURCE:

-  [View CY24713SXCT on WIN SOURCE](#)
-  [Cypress Semiconductor Corp](#) Information

## Optimize Your Supply Chain with WIN SOURCE Solutions

-  Global Sourcing Solution
-  Obsolete Management
-  Cost Control Management
-  Shortage Management
-  Alternative Solution
-  Excess Inventory Management