

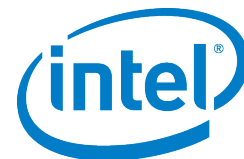

**THE DATASHEET OF  
EM2120H01QI**





# Intel® Enpirion® Power Solutions

## EM2120x01QI 20A PowerSoC

### Step-Down DC-DC Switching Converter with Integrated Inductor, Featuring Digital Control with PMBus™ v1.2 Compliant Interface

#### Description

The EM2120 is a fully integrated 20A PowerSoC synchronous buck converter. It features an advanced digital controller, gate drivers, synchronous MOSFET switches, and a high-performance inductor. Only input and output filter capacitors and a few small signal components are required for a complete solution. A PMBus version 1.2 compliant interface provides setup, control, and telemetry.

Differential remote sensing and  $\pm 0.5\%$  set-point accuracy provides precise regulation over line, load and temperature variation. Very low ripple further reduces accuracy uncertainty to provide best in class static regulation for today's FPGAs, ASICs, processors, and DDR memory devices.

The EM2120 may be used in standalone mode or utilizing the PMBus interface for a high degree of flexibility and programmability. Advanced digital control techniques ensure stability and excellent dynamic performance, and eliminate the need for external compensation components. The PC-based Intel Enpirion Digital Power Configurator provides a user-friendly and easy-to-use interface to the device for communication and configuration.

The EM2120 features high conversion efficiency and superior thermal performance to minimize thermal de-rating limitations, which is key to product reliability and longevity.

#### Features

- Integrated inductor, FETs, and digital controller
- Wide 4.5V to 16V  $V_{IN}$  range
- 0.7V to 5V  $V_{OUT}$  range
- 20A continuous current with no thermal de-rating
- High efficiency in 11mm x 17mm x 6.76mm QFN package
  - 95% efficiency at  $V_{IN} = 5V$ ,  $V_{OUT} = 3.3V$
  - 90% efficiency at  $V_{IN} = 12V$ ,  $V_{OUT} = 1.2V$
- Optimized total solution size of only 365 mm<sup>2</sup>
- Meets all high-performance FPGA requirements
  - Digital loop for best in class transient response
  - 0.5% set-point over line, load, and temperature
  - Output ripple as low as 10 mV peak-peak
  - Differential remote sensing
  - Monotonic startup into pre-bias output
  - Optimized FPGA configs stored in NVM
- Programmable through PMBus™
  - $V_{OUT}$  margining, startup and shutdown delays
  - Programmable warnings, faults and response
- Ability to operate without PMBus™
  - RVSET resistor for programmable  $V_{OUT}$
  - RTUNE resistor for single resistor compensation
- Tracking pin for complex sequencing
- RoHS compliant, MSL level 3, 260°C reflow

#### Applications

- High performance FPGA supply rails
- ASIC and processor supply rails
- High density double data rate (DDR) memory VDDQ rails

## Ordering Information

**Table 1**

Part Number	Supported $V_{OUT}$ Range	Package Markings	Package Description
EM2120L01QI	0.7V to 1.325V	M2120L	17 mm x 11 mm x 6.76 mm QFN104 provided in 112 units per tray
EM2120H01QI	1.35V to 5V	M2120H	17 mm x 11 mm x 6.76 mm QFN104 provided in 112 units per tray
EVB-EM2120L01	0.7V to 1.325V	Evaluation board; 20A single phase	
EVB-EM2120H01	1.35V to 5V	Evaluation board; 20A single phase	
EVI-EM2COMIF	GUI interface dongle		

**Packing and Marking Information:** [www.altera.com/support/reliability/packing/rel-packing-and-marking.html](http://www.altera.com/support/reliability/packing/rel-packing-and-marking.html)



## Pin Description

Table 2

PIN	NAME	I/O	FUNCTION
1,2,3, 79-101	VOUT	Regulated Output	Regulated output voltage. Decouple to PGND with appropriate filter capacitors
4	RVSET	Analog I/O	A resistor from RVSET to AGND; and can be used to program the $V_{OUT}$ set-point. Using 1% tolerance or better resistor. See <a href="#">Table 8</a> and <a href="#">Table 9</a> for more information.
5	RTUNE	Analog I/O	A resistor from RTUNE to AGND; and can be used to tune the transient compensator for the amount of output capacitance. Using 1% tolerance or better resistor. See <a href="#">Table 11</a> and <a href="#">Table 12</a> for more information.
6	VINSEN	Analog Input	Single-ended input voltage sense (relative to AGND).
7	ADDR1	Analog I/O	A resistor from ADDR1 to AGND; and can be used to set the PMBus™ address. Use a 1% tolerance or better resistor.
8	ADDR0	Analog I/O	A resistor from ADDR0 to AGND; and can be used to set the PMBus™ address. Use a 1% tolerance or better resistor.
9	PWM	PWM	PWM signal test pin.
10	SYNC	Digital I/O	PWM synchronization signal
11	POK	Digital I/O	Power OK is selectable as a push-pull output or an open drain transistor for power system state indication. See the Power OK description for details
12	CTRL	Digital Input	PMBus-compatible control pin with programmable functionality. CTRL should never be left floating if enabled in Configuration. The default configuration is for $V_{OUT}$ to be on with CTRL high (positive edge)
13	SALRT	Digital Output	PMBus™ alert line.
14	SDA	Digital I/O	PMBus™ serial data I/O.
15	SCL	Digital Input	PMBus™ serial clock input.
16	VDD33	Output	3.3V output of the internal LDO. May be used as pull-up supply for PMBus™ pins and CTRL pin.
17-21, 61-64, 103	PVIN	Input Supply	Input supply for MOSFET switches. Decouple to PGND with appropriate filter capacitors. Refer to Recommended Application Circuit section for more details.
22-60, 104	PGND	Ground	Power ground. Ground for MOSFET switches.
65	PVCC	Input Supply	5.0V supply voltage for driver circuitry. Decouple to PGND using a 2.2µF MLCC high quality ceramic capacitor.
66	VCC	Input Supply	5.0V supply voltage for analog circuitry.
67,68, 73-76	NC	NC	No connect. Do not connect to any signal, supply, or ground.
69	DGND	Ground	Digital ground. Connect to AGND pin directly.

Data Sheet | Intel Enpirion Power Solutions: EM2120

PIN	NAME	I/O	FUNCTION
70, 102	AGND	Ground	Analog ground. Connect to system ground plane. Refer to layout section for more details on grounding.
71	VSENP	Analog Input	Differential output voltage sense input (positive).
72	VSENN	Analog Input	Differential output voltage sense input (negative).
77	VTRACK	Analog Input	Voltage tracking reference input if EM2120 is configured for voltage tracking mode. May remain floating if not used. <b>If enabled but not used, connect to VDD33 using a 10kΩ resistor.</b> VTRACK is not enabled in the default configuration.
78	VCCSEN	Analog Input	Single-ended VCC voltage sense (relative to AGND)

## Absolute Maximum Ratings

**CAUTION:** Absolute Maximum ratings are stress ratings only. Functional operation beyond the recommended operating conditions is not implied. Stress beyond the absolute maximum ratings may impair device life. Exposure to absolute maximum rated conditions for extended periods may affect device reliability. Voltage measurements are referenced to AGND.

## Absolute Maximum Pin Ratings

Table 3

PARAMETER	SYMBOL	MIN	MAX	UNITS
Supply voltage PVIN	PVIN	-0.3	18	V
Supply voltage VCC	VCC	-0.3	5.5	V
VCC ramp time	VCC		20	ms
VDD33	VDD33	-0.3	3.6	V
Digital ground	DGND	-0.3	0.1	V
Power ground	PGND	-0.3	0.3	V
Digital I/O pins	SALRT, POK, SYNC,	-0.3	5.5	V
Digital I/O pins	SCL, SDA, CTRL	-0.3	3.6	V
Analog I/O pins	VINSEN, VCCSEN, ADDR0, ADDR1, RVSET, RTUNE, VTRACK	-0.3	2.0	V
Voltage feedback	VSENP, VSENN	-0.3	2.0	V
PWM pin	PWM	-0.3	5.5	V
Output voltage pins	VOUT	-0.3	5.5	V
DC current on VOUT	VOUT		23	A

## Absolute Maximum Thermal Ratings

PARAMETER	CONDITION	MIN	MAX	UNITS
Operating junction temperature			+125	°C
Storage temperature range		-65	+150	°C
Reflow peak body temperature	(10 Sec) MSL3		+260	°C

## Absolute Maximum ESD Ratings

PARAMETER	CONDITION	MIN	MAX	UNITS
HBD	All pins; Except VINSEN 1000 V Max	2000		V
CDM; all pins		500		V

## Recommended Operating Conditions

Table 4

PARAMETER	PINS	MIN	MAX	UNITS
PVIN supply voltage range	PVIN	4.5	16	V
Supply voltage $V_{CC}$ & $PV_{CC}$	VCC, PVCC	4.75	5.25	V
Continuous load current	$V_{OUT}$		20	A
Junction Temperature <i>(Note 1)</i>		-40	125	°C

*(Note 1):* OTP default is set to 120°C for safety margin

## Thermal Characteristics

Table 5

PARAMETER	PINS	TYPICAL	UNITS
Thermal shutdown [programmable]	$T_{SD}$	120	°C
Thermal shutdown Hysteresis	$T_{SDH}$	18	°C
Thermal resistance: junction to ambient (0 LFM) <i>(Note 2)</i>	$\theta_{JA}$	8	°C/W
Thermal resistance: junction to case bottom (0 LFM)	$\theta_{JC}$	1.5	°C/W

*(Note 2):* Based on 2 oz. external copper layers and proper thermal design in line with EIJ/JEDEC JESD51 standards for high thermal conductivity boards. No top side cooling required.

## Electrical Characteristics

$PV_{IN} = 12V$  and  $V_{CC} = 5.0V$ . The minimum and maximum values are over the ambient temperature range (-40°C to 85°C) unless otherwise noted. Typical values are at  $T_A = 25^\circ C$ .

**Table 6**

PARAMETER	SYMBOL	TEST CONDITIONS	MIN	TYP	MAX	UNITS	
<b>SUPPLY CHARACTERISTICS</b>							
PVIN supply voltage range	PVIN		4.5		16	V	
PVIN supply quiescent current		Device switching; no load; $f_{sw} = 800$ kHz; $V_{OUT} = 1.0V$		40		mA	
		Device not switching		1			
VCC supply voltage range	VCC		4.75	5.0	5.25	V	
VCC UVLO rising				4.4		V	
VCC UVLO falling				4.2		V	
PVCC & VCC supply current		Normal operation; no load; $f_{sw} = 800$ kHz		80	100	mA	
		Normal operation; no load; $f_{sw} = 1.33$ MHz		120	150 <sup>(1)</sup>	mA	
		Idle; communication and telemetry only; no switching			30		mA
		Disabled ( $V_{CC} \leq 2.8V$ )			900		$\mu A$
<b>INTERNALLY GENERATED SUPPLY VOLTAGE</b>							
VDD33 voltage range	VDD33		3.0	3.3	3.6		
VDD33 output current					2	mA	
<b>DIGITAL I/O PINS (POK, SYNC)</b>							
Input high voltage			2.0		5.5	V	
Input low voltage			0		0.8	V	
Output high voltage			2.4		VDD33	V	
Output low voltage					0.4	V	
Input leakage current					$\pm 1$	$\mu A$	
Output current - source					2.0	mA	
Output current - sink					2.0	mA	
<b>DIGITAL I/O PIN (CTRL)</b>							
Input high voltage			2.0		3.6	V	
Input low voltage			-0.3		0.8	V	

PARAMETER	SYMBOL	TEST CONDITIONS	MIN	TYP	MAX	UNITS
CTRL response delay (stop)		Configurable polarity; extra turn-off delay configurable (assumes 0 s turn-off delay)		150		μs
CTRL response delay (start)		Configurable polarity; extra turn-on delay configurable (assumes 0 s turn-on delay)		250		μs
<b>HKADC INPUT PINS (VINSEN, VCCSEN, ADDR0 AND ADDR1)</b>						
Input voltage			0		1.44	V
<b>PWM AND SYNCHRONIZATION</b>						
PWM output voltage - high			2.4			V
PWM output voltage - low					0.4	V
PWM tristate leakage					±1	μA
PWM pulse width			30			ns
Resolution				163		ps
Switching frequency – EM2120L	f <sub>sw</sub>	With internal oscillator		800		kHz
Switching frequency – EM2120H	f <sub>sw</sub>	With internal oscillator		1333		kHz
SYNC frequency range		Percent of nominal switching frequency			±12.5	%
SYNC pulse width			25			ns
<b>OUTPUT VOLTAGE SENSE, REPORTING, AND MANAGEMENT</b>						
Output voltage adjustment range	EM2120L		0.7		1.325	V
	EM2120H		1.35		5	V
Output voltage set-point accuracy	EM2120L	0°C < T <sub>A</sub> < 85°C	-0.5		+0.5	%
	EM2120L	-40°C < T <sub>A</sub> < 85°C	-1		+1	%
	EM2120H	-40°C < T <sub>A</sub> < 85°C	-1		+1	%
Output set-point resolution	EM2120L			1.5		mV
Line regulation				0.007		mV/V
Load regulation				0.07		mV/A
Output voltage startup delay		From V <sub>CC</sub> valid, to start of output voltage ramp, if configured to regulate from power on reset, and TON_DELAY is set to 0.		5		ms

PARAMETER	SYMBOL	TEST CONDITIONS	MIN	TYP	MAX	UNITS
Output voltage ramp delay (TON_DELAY & TOFF_DELAY)		Configurable, no V <sub>OUT</sub> pre-bias condition.	0		500	ms
V <sub>out</sub> slew rate				0.5		V/ms
VTRACK ramp rate					2.0	V/ms
VTRACK range		Without resistor divider	0		1.4	V
VTRACK offset voltage				±100		mV
<b>OUTPUT CURRENT SENSE, REPORTING, AND MANAGEMENT</b>						
Current sense reporting accuracy		I <sub>OUT</sub> > 5A, 25°C ≤ T <sub>A</sub> < 85°C		±1.5		A
		I <sub>OUT</sub> > 5A, T <sub>A</sub> = 25°C		±1		A
<b>TEMPERATURE SENSE, REPORTING, AND MANAGEMENT</b>						
Temperature reporting accuracy				±5		°C
Resolution				0.22		°C
<b>FAULT MANAGEMENT PROTECTION FEATURES</b>						
PV <sub>IN</sub> UV threshold				3.96		V
PVIN OV threshold				16.5		V
V <sub>OUT</sub> OV threshold		Percentage of output voltage		115		%
V <sub>OUT</sub> UV threshold		Percentage of output voltage		85		%
I <sub>OUT</sub> OCP		DC Current Value	25	30	35	A
OTP threshold				120		°C
OTP hysteresis		Fixed.		85		%
POK threshold		On level		95		%
POK threshold		Off level		90		%
Watchdog Timer Interval					3	ms
<b>SERIAL COMMUNICATION PMBUS DC CHARACTERISTICS</b>						
Input voltage – high (VIH)		SCL and SDA	1.11			V
Input voltage – low (VIL)		SCL and SDA			0.8	V
Rise & Fall Time		SCL and SDA >0.8V<1.1V			2	ms
Input leakage current		SCL, SDA and CTRL.	-10		10	µA
leakage current		SALRT		65		µA
Output voltage – low (VOL)		SDA and SALRT at rated pull-up current of 20mA.			0.4	V

Data Sheet | Intel Enpirion Power Solutions: EM2120

PARAMETER	SYMBOL	TEST CONDITIONS	MIN	TYP	MAX	UNITS
Nominal bus voltage		SCL and SDA termination voltage.			3.6	V
Nominal SLART voltage		SALRT termination voltage.		3.3	3.6	V
(1) These values are provided for information only						

## Typical Performance Characteristics

All the performance curves are measured with EM2120 evaluation board at 25°C ambient temperature unless otherwise noted. Thermal performance dependent on overall board design. The output capacitors configuration for the evaluation board is 2 x 470 µF (3 mΩ ESR) + 4 x 100 µF (Ceramic) + 4 x 47 µF (Ceramic) for EM2120L and 2 x 220 µF (5 mΩ ESR) + 6 x 47 µF (Ceramic) for EM2120H.

Efficiency,  $V_{IN} = 12V$

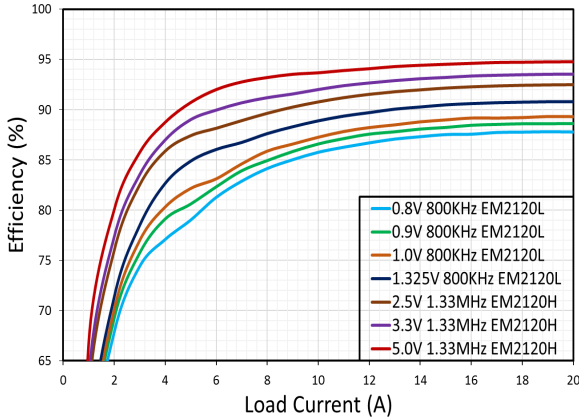

Efficiency,  $V_{IN} = 5V$

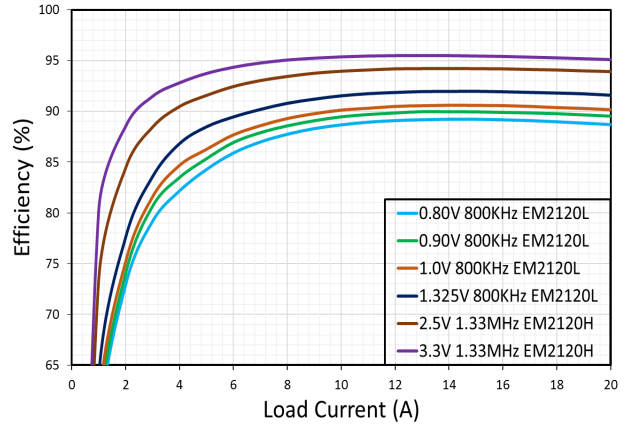

EM2120L Typical Thermal Derating, No Airflow

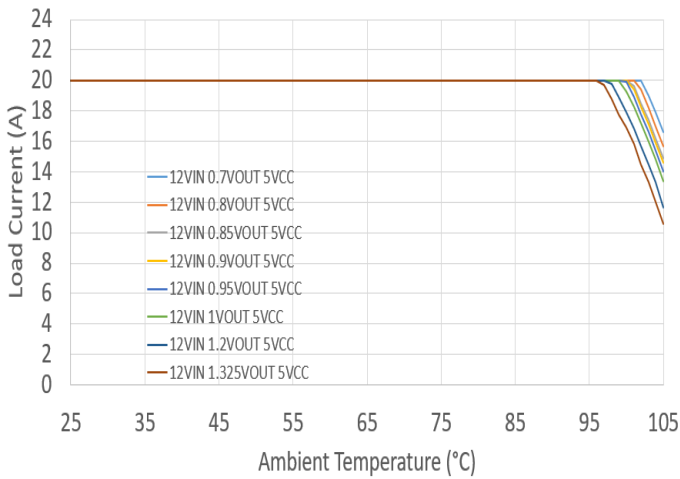

EM2120H Typical Thermal Derating, No Airflow

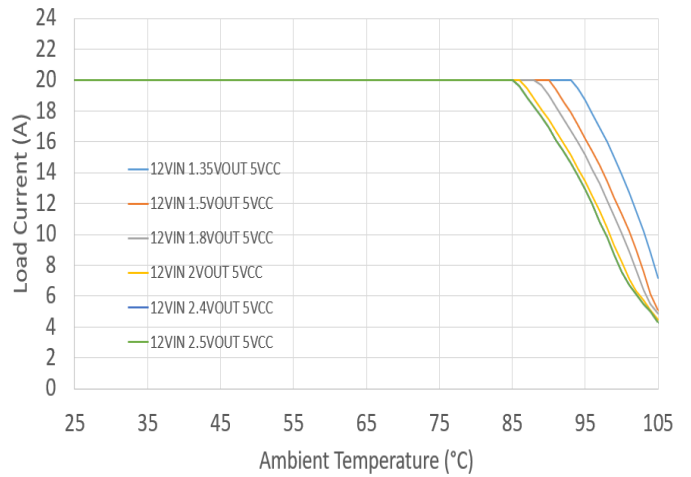

**EM2120L Line Regulation,  $V_{OUT} = 0.9V$**

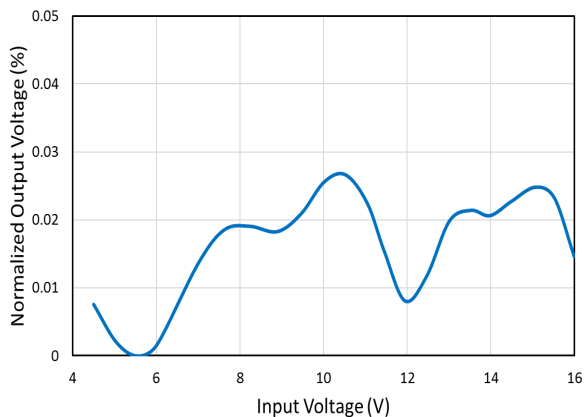

**EM2120L Load Regulation,  $V_{OUT} = 0.9V$**

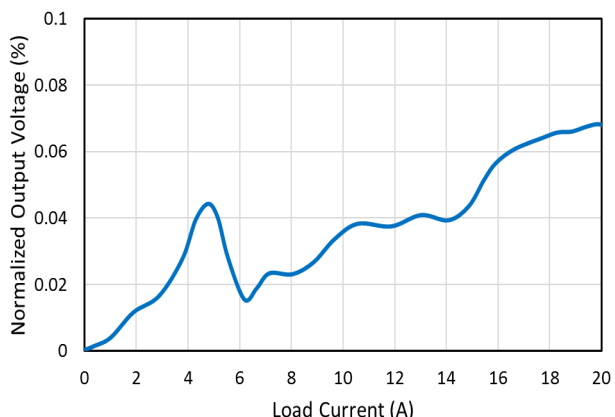

**Start-up/Shutdown,  $PV_{IN}$  At No Load, 20 ms/div**

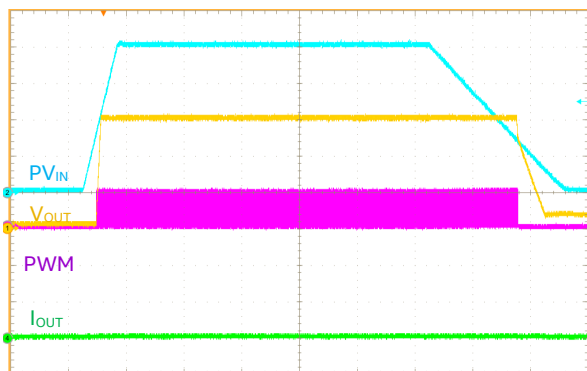

$PV_{IN}$  and PWM: 3 V/div,  
 $V_{OUT}$ : 300 mV/div,  $I_{OUT}$ : 10 A/div

**Start-up/Shutdown,  $PV_{IN}$  At 20A Load, 20 ms/div**

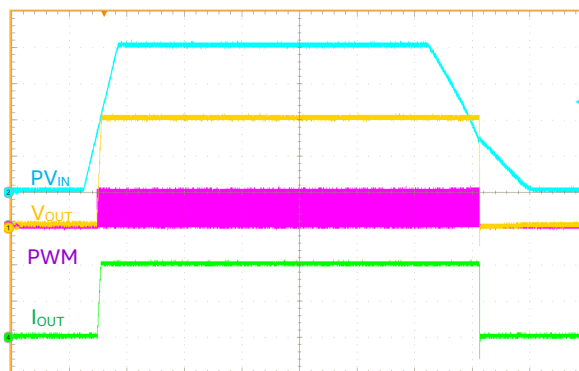

$PV_{IN}$  and PWM: 3 V/div,  
 $V_{OUT}$ : 300 mV/div,  $I_{OUT}$ : 10 A/div

**Start-up/Shutdown, CTRL At No Load, 10 ms/div**

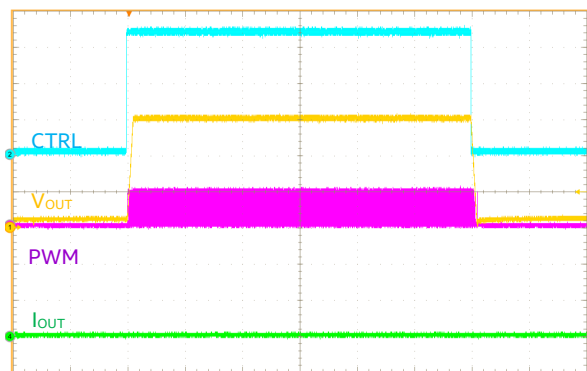

CTRL: 1 V/div, PWM: 3 V/div,  
 $V_{OUT}$ : 300 mV/div,  $I_{OUT}$ : 10 A/div

**Start-up/Shutdown, CTRL At 20A Load, 10 ms/div**

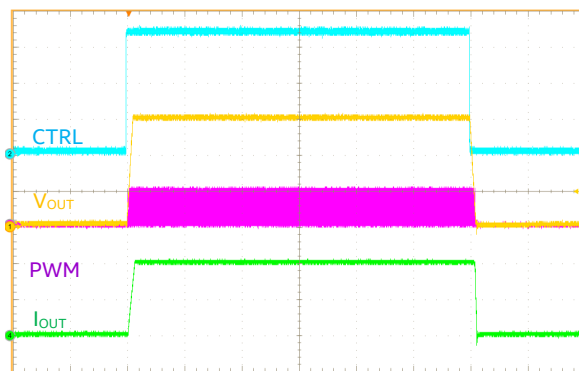

CTRL: 1 V/div, PWM: 3 V/div,  
 $V_{OUT}$ : 300 mV/div,  $I_{OUT}$ : 10 A/div

**Start-up Into 0.6V Pre-Bias With  $PV_{IN}$ , 2 ms/div**

**Start-up Into 0.6V Pre-Bias With CTRL, 2 ms/div**

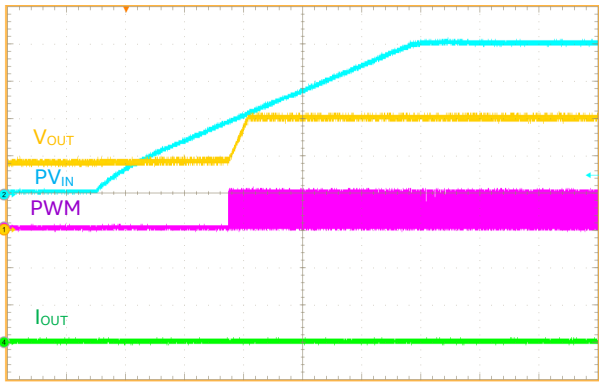

PV<sub>IN</sub>: 3 V/div, PWM: 3 V/div,  
V<sub>OUT</sub>: 300 mV/div, I<sub>OUT</sub>: 10 A/div

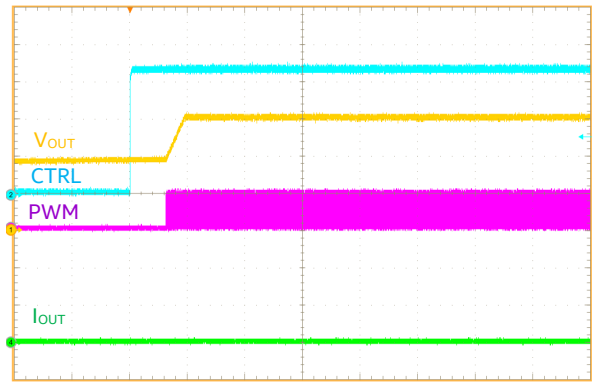

CTRL: 1 V/div, PWM: 3 V/div,  
V<sub>OUT</sub>: 300 mV/div, I<sub>OUT</sub>: 10 A/div

## Typical Performance Characteristics (Continued)

### Output Voltage Ripple, No Load

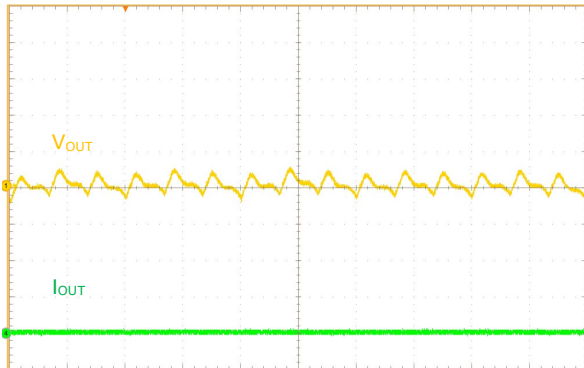

$V_{IN} = 12V, V_{OUT} = 0.9V$   
 $2 \mu s/div, V_{OUT}: 10 mV/div, 20 MHz bandwidth$

### Output Voltage Ripple, 20A Load

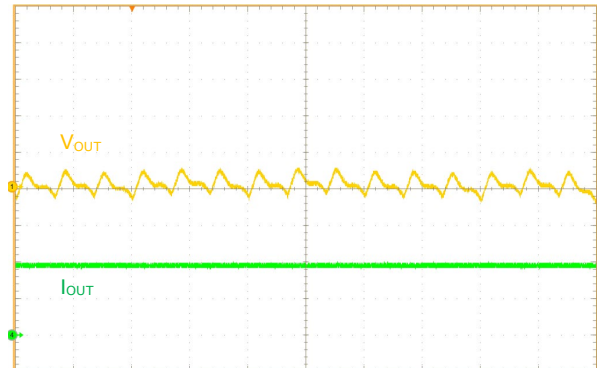

$V_{IN} = 12V, V_{OUT} = 0.9V$   
 $2 \mu s/div, V_{OUT}: 10 mV/div, 20 MHz bandwidth$

### Output Voltage Transient Response, Load Step From 0A To 10A

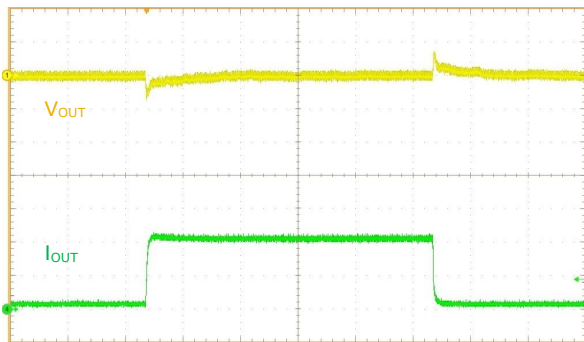

$V_{IN} = 12V, V_{OUT} = 0.9V, 100 \mu s/div$   
 $V_{OUT}: 30 mV/div, I_{OUT}: 5A/div, 10A/\mu s$

### Output Voltage Transient Response, Load Step From 10A To 20A

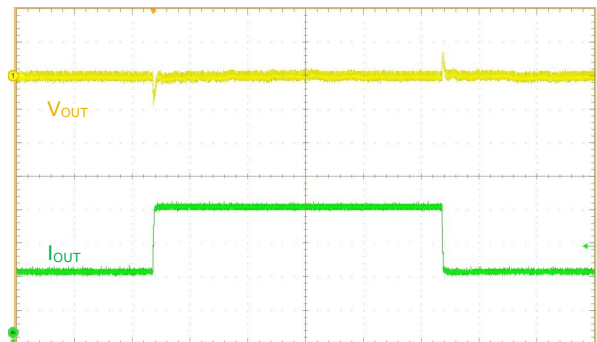

$V_{IN} = 12V, V_{OUT} = 0.9V, 100 \mu s/div$   
 $V_{OUT}: 30 mV/div, I_{OUT}: 5A/div, 10A/\mu s$

### Output Voltage Transient Response, Load Step From 0A To 10A

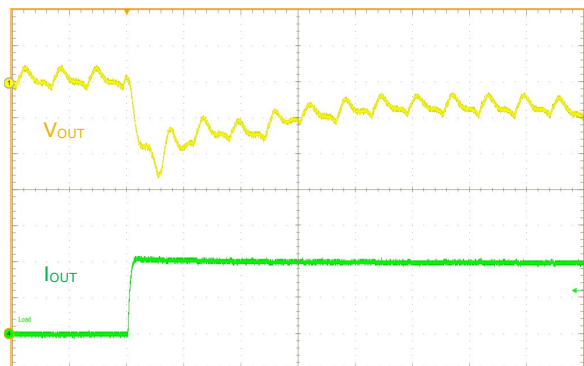

$V_{IN} = 12V, V_{OUT} = 0.9V, 2 \mu s/div$   
 $V_{OUT}: 10 mV/div, I_{OUT}: 5A/div, 10A/\mu s$

### Output Voltage Transient Response, Load Step From 0A To 10A

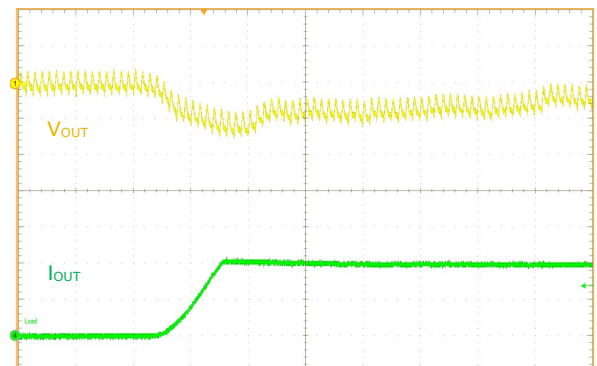

$V_{IN} = 12V, V_{OUT} = 0.9V, 10 \mu s/div$   
 $V_{OUT}: 10 mV/div, I_{OUT}: 5A/div, 1A/\mu s$

## Functional Block Diagram

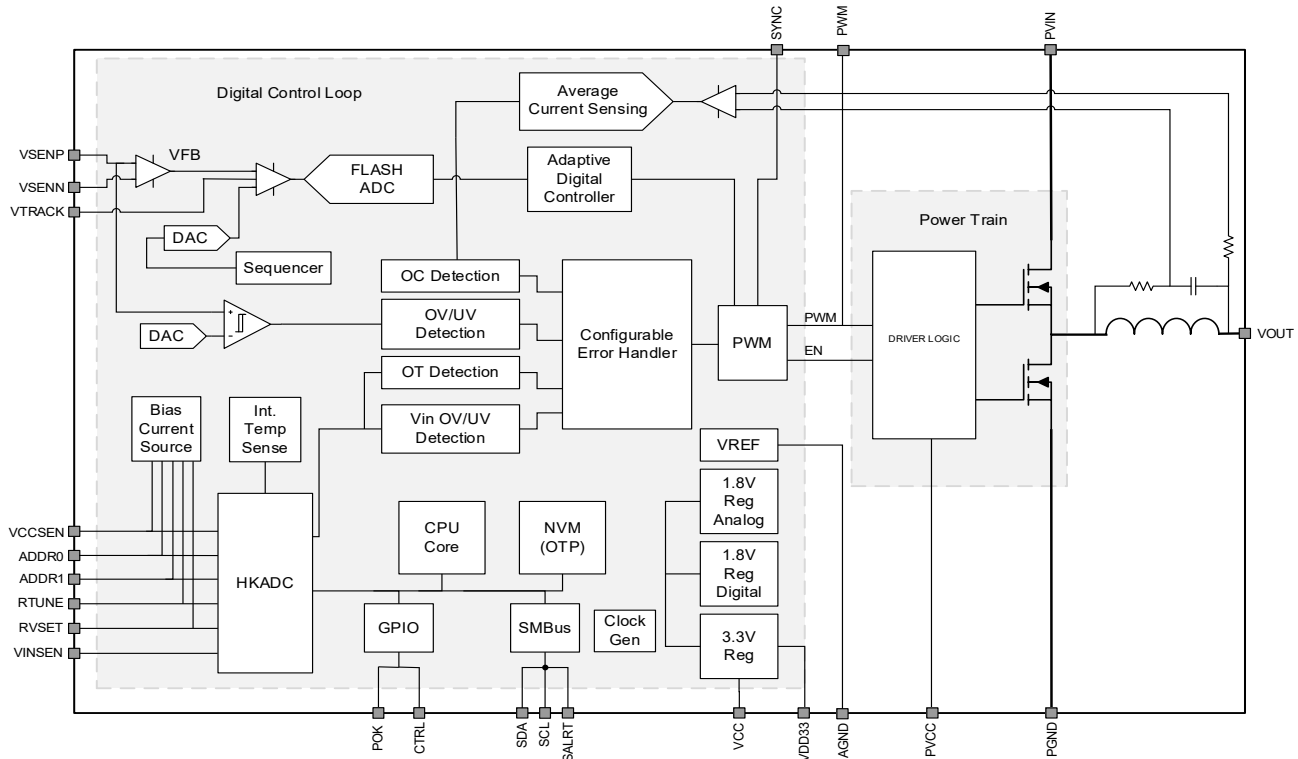

Figure 2: Functional Block Diagram

## Functional Description

### FUNCTIONAL DESCRIPTION: DEFAULT CONFIGURATION

The EM2120 is a single output digital PowerSoC synchronous step-down converter with advanced digital control techniques, capable of supplying up to 20A of continuous output current. The PowerSoC includes integrated power MOSFETs, a high-performance inductor and a digital controller which offers a PMBus version 1.2 compliant interface to support an extensive suite of telemetry, configuration and control commands.

In the default configuration, the EM2120 requires only two resistors total to set the output voltage and set the digital compensator for the most optimized performance. This easy-to-use default configuration allows the user to tune the EM2120 to meet the most demanding accuracy and load transient requirements without requiring any programming or digital interface. The following sections describe the default configuration. Refer to the Advanced Configuration section for details on the many ways the EM2120 may be customized and configured through the PMBus interface.

In order to optimize size versus efficiency over a wide range of operating conditions, there are two module variants – a low output voltage variant EM2120L01 ( $0.7V \leq V_{OUT} \leq 1.325V$ ) which operates at 800KHz and a high output voltage variant EM2120H01 ( $1.35V \leq V_{OUT} \leq 5V$ ) which operates at 1.33MHz.

The advanced digital control loop works as a voltage-mode controller using a PID-type compensation. The basic structure of the controller is shown in Figure 3. The EM2120 controller features two PID compensators for steady-state operation and fast transient operation. Fast, reliable switching between the different

compensation modes ensures good transient performance and quiet steady state performance. The EM2120 has been pre-programmed with a range of default compensation coefficients which lets the user select the best compensation for the best transient response and stability for the output capacitance of the system.

The EM2120 uses two additional technologies to improve transient performance. First, the EM2120 uses over-sampling techniques to acquire fast, accurate, and continuous information about the output voltage so that the device can react quickly to any changes in output voltage. Second, a non-linear gain adjustment is applied during large load transients to boost the loop gain and reduce the settling time.

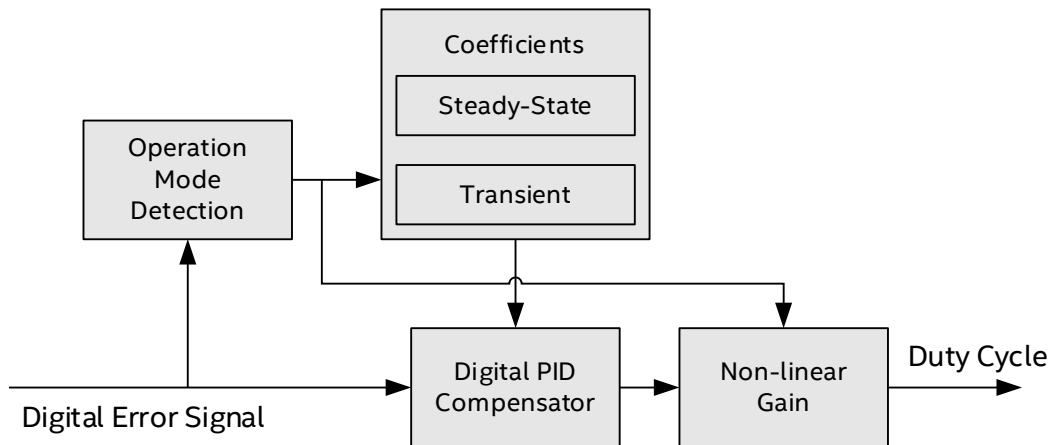

**Figure 3: Simplified Block Diagram Of The Digital Compensation**

In the default configuration, the EM2120 offers a complete suite of fault warnings and protections. Input and output Under Voltage Lock-Out (UVLO) and Over Voltage Lock-Out (OVLO) conditions are continuously monitored. A dedicated ADC is used to provide fast and accurate current information over the switching period allowing for fast Over-Current Protection (OCP) response. Over Temperature Protection (OTP) is accomplished by direct monitoring of the device's internal temperature.

## POWER ON RESET

The EM2120 employs an internal power-on-reset (POR) circuit to ensure proper start-up and shut down with a changing supply voltage. Once the VCC supply voltage increases above the POR threshold voltage, the EM2120 begins the internal start-up process. Upon its completion, the device is ready for operation.

Two separate input voltage supplies are necessary to operate, PVIN (4.5V to 16V) and VCC (4.75V to 5.25V). Both of these voltage rails must be monitored for proper power-up and to protect the power MOSFETs under various input power fault conditions. A voltage divider on each input voltage supply connected to VINSSEN for the power rail (PVIN) and VCCSEN for the supply rail (VC) is used for digital monitoring of the supplies.

As illustrated in [Figure 4](#), the values of resistors R1, R2, R3 and R4 are chosen so the internal monitor ADC does not saturate within the appropriate ranges. This allows the EM2120 telemetry to report when the recommended operation voltage has been exceeded.

It is mandatory that the listed resistors values are used in order to ensure proper operation with the EM2120 default configuration. The resistors used must be R1=11 kΩ, R2=1 kΩ, R3=10 kΩ and R4=3.3 kΩ, using 1% tolerance or better resistors. If these values are not used, then the EM2120 will read incorrect values for both PVIN and VCC.

Digital filtering is provided inside the EM2120 but if additional filtering is needed due to high noise on either rail, a capacitor can be connected between each pin (VINSEN & VCCSEN) and ground to maintain high accuracy.

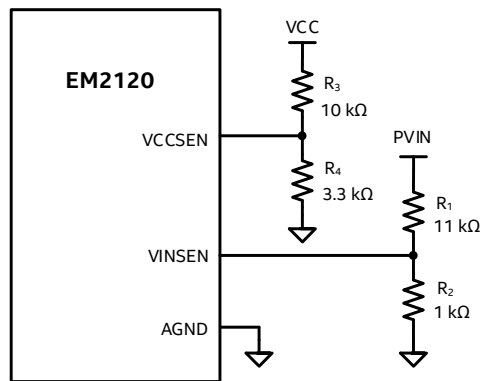
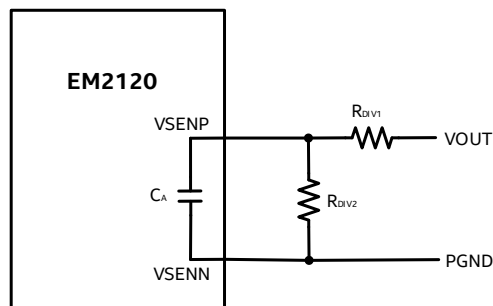

**Figure 4: VINSEN And VCCSEN Input Resistor Dividers**

The EM2120 also uses the PVIN monitor for input voltage feed-forward, which eliminates variations in the output voltage due to sudden changes in the input voltage supply. It does this by immediately changing the duty cycle to compensate for the input supply variation by normalizing the DC gain of the loop.

## SETTING THE OUTPUT VOLTAGE

Differential remote sensing provides for precise regulation at the point of load. One of thirty output voltages may be selected in the default configuration, based on a resistor connected to the RVSET pin. At power-up, an internal current source biases the resistor and the voltage is measured by an ADC to decode the Vout selection. Use the RVSET tables ([Table 8](#) and [Table 9](#)) for the details of VOUT selection and RVSET values.



**Figure 5: Output Voltage Sense Circuitry**

The digital control loop ADC of the low voltage EM2120L01 supports direct output voltage feedback connection over the entire  $V_{OUT}$  range. For the high output voltage EM2120H01, a feedback divider is required as shown in [Figure 5](#). The resistor values in [Table 7](#) are required as a function of the output voltage selection. It is mandatory that the listed resistor values are used, use of other values may result in poor regulation performance as these values are expected in the EM2120 default configuration. Resistors with tight tolerances are recommended to maintain output voltage accuracy.

The resistors in the feedback path also form a low-pass filter with the internal capacitor,  $C_A$ , for removing high-frequency disturbances from the sense signals. Place these components as close as possible to the EM2120 for best filtering performance.

**Table 7: Output Voltage Feedback Component**

Module	$V_{OUT}$	$R_{DIV1}$	$R_{DIV2}$
EM2120L01	$0.7V \leq V_{OUT} \leq 1.325V$	2 k $\Omega$	Open
EM2120H01	$1.35V \leq V_{OUT} \leq 2.6V$	2 k $\Omega$	2 k $\Omega$
EM2120H01	$2.7V \leq V_{OUT} \leq 3.8V$	2 k $\Omega$	1 k $\Omega$
EM2120H01	$3.8V < V_{OUT} \leq 5V$	2 k $\Omega$	665 $\Omega$

**Table 8: Supported Configuration Voltage Values For EM2120L01 Output Voltage**

RVSET Resistor	$V_{OUT}$	External Resistor Divider
0k $\Omega$	Reserved	$R_{1DIV} = 2k\Omega, R_{2DIV} = \text{open}$
0.392k $\Omega$	Reserved	$R_{1DIV} = 2k\Omega, R_{2DIV} = \text{open}$
0.576k $\Omega$	Reserved	$R_{1DIV} = 2k\Omega, R_{2DIV} = \text{open}$
0.787k $\Omega$	Reserved	$R_{1DIV} = 2k\Omega, R_{2DIV} = \text{open}$
1.000k $\Omega$	1.325V	$R_{1DIV} = 2k\Omega, R_{2DIV} = \text{open}$
1.240k $\Omega$	1.3V	$R_{1DIV} = 2k\Omega, R_{2DIV} = \text{open}$
1.500k $\Omega$	1.275V	$R_{1DIV} = 2k\Omega, R_{2DIV} = \text{open}$
1.780k $\Omega$	1.25V	$R_{1DIV} = 2k\Omega, R_{2DIV} = \text{open}$
2.100k $\Omega$	1.225V	$R_{1DIV} = 2k\Omega, R_{2DIV} = \text{open}$
2.430k $\Omega$	1.2V	$R_{1DIV} = 2k\Omega, R_{2DIV} = \text{open}$
2.800k $\Omega$	1.175V	$R_{1DIV} = 2k\Omega, R_{2DIV} = \text{open}$
3.240k $\Omega$	1.15V	$R_{1DIV} = 2k\Omega, R_{2DIV} = \text{open}$
3.740k $\Omega$	1.12V	$R_{1DIV} = 2k\Omega, R_{2DIV} = \text{open}$
4.220k $\Omega$	1.1V	$R_{1DIV} = 2k\Omega, R_{2DIV} = \text{open}$
4.750k $\Omega$	1.075V	$R_{1DIV} = 2k\Omega, R_{2DIV} = \text{open}$
5.360k $\Omega$	1.05V	$R_{1DIV} = 2k\Omega, R_{2DIV} = \text{open}$
6.040k $\Omega$	1.03V	$R_{1DIV} = 2k\Omega, R_{2DIV} = \text{open}$
6.810k $\Omega$	1.0V	$R_{1DIV} = 2k\Omega, R_{2DIV} = \text{open}$
7.680k $\Omega$	0.975V	$R_{1DIV} = 2k\Omega, R_{2DIV} = \text{open}$
8.660k $\Omega$	0.95V	$R_{1DIV} = 2k\Omega, R_{2DIV} = \text{open}$
9.530k $\Omega$	0.925V	$R_{1DIV} = 2k\Omega, R_{2DIV} = \text{open}$
10.500k $\Omega$	0.9V	$R_{1DIV} = 2k\Omega, R_{2DIV} = \text{open}$
11.800k $\Omega$	0.875V	$R_{1DIV} = 2k\Omega, R_{2DIV} = \text{open}$
13.000k $\Omega$	0.85V	$R_{1DIV} = 2k\Omega, R_{2DIV} = \text{open}$
14.300k $\Omega$	0.825V	$R_{1DIV} = 2k\Omega, R_{2DIV} = \text{open}$
15.800k $\Omega$	0.8V	$R_{1DIV} = 2k\Omega, R_{2DIV} = \text{open}$
17.400k $\Omega$	0.775V	$R_{1DIV} = 2k\Omega, R_{2DIV} = \text{open}$

RVSET Resistor	V <sub>OUT</sub>	External Resistor Divider
19.100kΩ	0.75V	R <sub>1DIV</sub> = 2kΩ, R <sub>2DIV</sub> = open
21.000kΩ	0.725V	R <sub>1DIV</sub> = 2kΩ, R <sub>2DIV</sub> = open
23.200kΩ	0.7V	R <sub>1DIV</sub> = 2kΩ, R <sub>2DIV</sub> = open

Table 9: Supported Configuration Voltage Values For EM2120H01 Output Voltage

RVSET Resistor	V <sub>OUT</sub>	External Resistor Divider
0kΩ	Reserved	R <sub>1DIV</sub> = 2kΩ, R <sub>2DIV</sub> = 1kΩ
0.392kΩ	Reserved	R <sub>1DIV</sub> = 2kΩ, R <sub>2DIV</sub> = 1kΩ
0.576kΩ	3.3V	R <sub>1DIV</sub> = 2kΩ, R <sub>2DIV</sub> = 1kΩ
0.787kΩ	3.2V	R <sub>1DIV</sub> = 2kΩ, R <sub>2DIV</sub> = 1kΩ
1.000kΩ	3.1V	R <sub>1DIV</sub> = 2kΩ, R <sub>2DIV</sub> = 1kΩ
1.240kΩ	3.0V	R <sub>1DIV</sub> = 2kΩ, R <sub>2DIV</sub> = 1kΩ
1.500kΩ	2.9V	R <sub>1DIV</sub> = 2kΩ, R <sub>2DIV</sub> = 1kΩ
1.780kΩ	2.8V	R <sub>1DIV</sub> = 2kΩ, R <sub>2DIV</sub> = 1kΩ
2.100kΩ	2.7V	R <sub>1DIV</sub> = 2kΩ, R <sub>2DIV</sub> = 1kΩ
2.430kΩ	2.6V	R <sub>1DIV</sub> = 2kΩ, R <sub>2DIV</sub> = 2kΩ
2.800kΩ	2.5V	R <sub>1DIV</sub> = 2kΩ, R <sub>2DIV</sub> = 2kΩ
3.240kΩ	2.4V	R <sub>1DIV</sub> = 2kΩ, R <sub>2DIV</sub> = 2kΩ
3.740kΩ	2.3V	R <sub>1DIV</sub> = 2kΩ, R <sub>2DIV</sub> = 2kΩ
4.220kΩ	2.2V	R <sub>1DIV</sub> = 2kΩ, R <sub>2DIV</sub> = 2kΩ
4.750kΩ	2.1V	R <sub>1DIV</sub> = 2kΩ, R <sub>2DIV</sub> = 2kΩ
5.360kΩ	2.0V	R <sub>1DIV</sub> = 2kΩ, R <sub>2DIV</sub> = 2kΩ
6.040kΩ	1.9V	R <sub>1DIV</sub> = 2kΩ, R <sub>2DIV</sub> = 2kΩ
6.810kΩ	1.8V	R <sub>1DIV</sub> = 2kΩ, R <sub>2DIV</sub> = 2kΩ
7.680kΩ	1.75V	R <sub>1DIV</sub> = 2kΩ, R <sub>2DIV</sub> = 2kΩ
8.660kΩ	1.7V	R <sub>1DIV</sub> = 2kΩ, R <sub>2DIV</sub> = 2kΩ
9.530kΩ	1.65V	R <sub>1DIV</sub> = 2kΩ, R <sub>2DIV</sub> = 2kΩ
10.500kΩ	1.6V	R <sub>1DIV</sub> = 2kΩ, R <sub>2DIV</sub> = 2kΩ
11.800kΩ	1.55V	R <sub>1DIV</sub> = 2kΩ, R <sub>2DIV</sub> = 2kΩ
13.000kΩ	1.5V	R <sub>1DIV</sub> = 2kΩ, R <sub>2DIV</sub> = 2kΩ
14.300kΩ	1.475V	R <sub>1DIV</sub> = 2kΩ, R <sub>2DIV</sub> = 2kΩ
15.800kΩ	1.45V	R <sub>1DIV</sub> = 2kΩ, R <sub>2DIV</sub> = 2kΩ
17.400kΩ	1.425V	R <sub>1DIV</sub> = 2kΩ, R <sub>2DIV</sub> = 2kΩ
19.100kΩ	1.4V	R <sub>1DIV</sub> = 2kΩ, R <sub>2DIV</sub> = 2kΩ

RVSET Resistor	V <sub>OUT</sub>	External Resistor Divider
21.000kΩ	1.375V	R <sub>1DIV</sub> = 2kΩ, R <sub>2DIV</sub> = 2kΩ
23.200kΩ	1.35V	R <sub>1DIV</sub> = 2kΩ, R <sub>2DIV</sub> = 2kΩ

**Note:** For 5V<sub>out</sub> operation select 2.8kΩ as the RVSET value and use external voltage divider values of R<sub>DIV1</sub> = 2kΩ & R<sub>DIV2</sub> = 665Ω. In this instance for the Command READ\_VOUT the read-back values need to be scaled up by a factor of 2.

## ENABLE AND OUTPUT START-UP BEHAVIOR

The control pin (CTRL) provides a means to enable normal operation or to shut down the device. When the CTRL pin asserted (high) the device will undergo a normal soft-start. A logic low on this pin will power the device down in a controlled manner. Dedicated pre-biased start-up logic ensures proper start-up of the power converter when the output capacitors are pre-charged to a non-zero output voltage. Closed-loop stability is ensured during this period.

The typical power sequencing, including ramp up/down and delays is shown in [Figure 6](#).

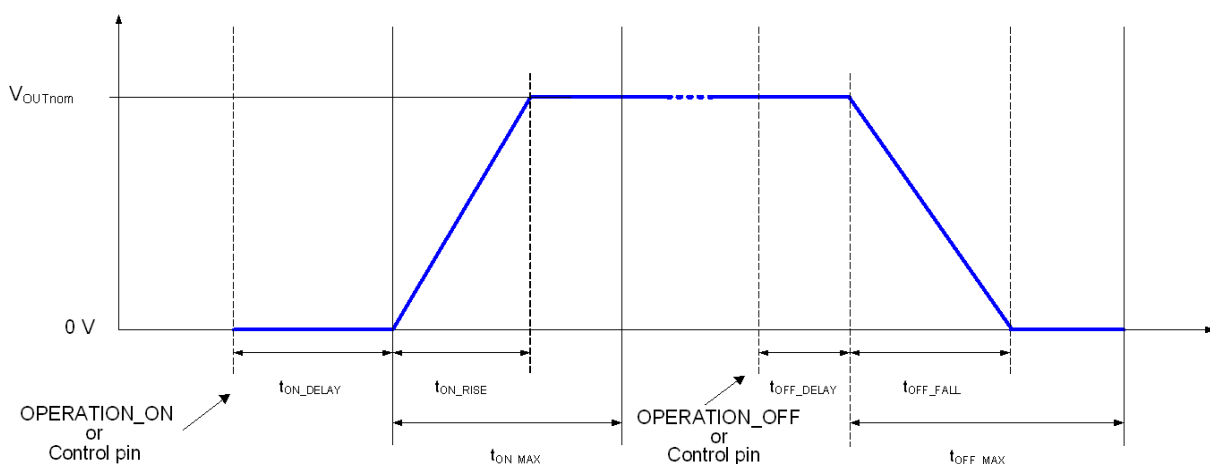

**Figure 6: Power Sequencing**

## POWER OK

The EM2120 has a power good indicator at its output pin, POK. When de-asserted, POK indicates that the output voltage is below the threshold value, 90% of the programmed output voltage in the default configuration. When asserted, POK indicates that the output is in regulation, and no major faults are present. As a result, POK de-asserts during any serious fault condition where power conversion stops and re-asserts when the output voltage recovers.

The POK indication can be either push-pull or open-drain, selected based upon the PMBus™ address. For addresses in the range 0x01 to 0x40, the POK signal is a push-pull output and no pull-up resistor is required. For addresses in the range 0x41 to 0x7F, the POK signal is open-drain and may be wire-OR's with other open drain signals with an appropriate pull-up resistor. The Pull-Up resistor may be connected to the VDD33 pin but it is not recommended to use the 5VCC supply. [Table 16](#) describes the resistor values which are used to set the PMBus address.

In a noisy application, it is strongly recommended that a 100nf decoupling capacitor be placed between the POK pin and GND to act as a filter to unwanted external noise . When configured as a Push-Pull output, a 10kΩ pull-down resistor to Gnd may be used instead to prevent any spurious noise spikes appearing on POK upon power being applied to the module.

## SMBAAlert Pin

The SMBAAlert pin is intended to operate using an external pull-up voltage of 3.3V and contains a weak internal pull-up.

If operating in applications with a lower voltage pull-up voltage, it is recommended that an external low Vf Schottky diode be placed at the input to localise this voltage.

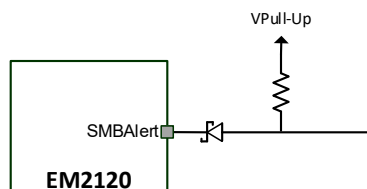

Figure 7: SMBAAlert Pin Low Voltage Pull-up Option

Table 10: Schottky Diode Options

Description	Manufacturer	P/N
40V, 300mA, Schottky, SOD523	ST	BAT54KFILM
40V, 250mA, Schottky, SOD523	Diode Inc	BAT64T5Q

## COMPENSATING THE DIGITAL CONTROL LOOP

To improve the transient performance for a typical point-of-load design, it is common to add output capacitance to the converter. This moves the output LC resonant frequency lower as capacitance increases which results in lower bandwidth, lower phase margin, and longer settling times unless the control loop is compensated for added capacitance.

However, with EM2120 the user does not need to be concerned with, or even understand, the details of control loop compensation techniques. The default configuration allows users to select from preconfigured PID control loop settings (known as compensators) through the use of pin-strapping. A single resistor from the RTUNE pin to AGND informs the EM2120 of the compensator selection.

The selection of the compensator is driven first by the type of output capacitors used, as the ESL and ESR of different capacitor types demands different PID coefficients to optimize transient deviation and recovery characteristics. An all ceramic output capacitor design requires a different compensator than a design with a combination of ceramic and polymer capacitors, i.e. POSCAP. [Table 13](#) shows several output capacitor part number recommendations.

The five different compensators can then be subdivided into groups of six each whereby the initial capacitance value in the appropriate compensator can be scaled upwards by multiplication factor M to match the additional capacitance.

Table 11: RTUNE configuration table for EM2120L01

Compensator Description	C <sub>OUT</sub>	RTUNE Resistor	Multiplication factor (M)	Typical Deviation With 50% Load Step
Polymer Aluminum (SP-CAP) and Ceramic MLCC Output Capacitors Base capacitance = 1 x 470µF (Polymer) + 2 x 100µF (Ceramic) + 2 x 47µF (Ceramic)	Base	0kΩ	1	± 5%
	2 x Base	0.392kΩ	2	± 3%
	3 x Base	0.576kΩ	3	
	4 x Base	0.787kΩ	4	± 1.5%
	5 x Base	1.000kΩ	5	
	6 x Base	1.240kΩ	6	
All MLCC Ceramic Output Capacitors Base capacitance = 8 x 100µF	Base	1.500kΩ	1	± 5%
	1.5 x Base	1.780kΩ	1.5	
	2 x Base	2.100kΩ	2	± 3%
	3 x Base	2.430kΩ	3	
	4 x Base	2.800kΩ	4	
	4.5 x Base	3.240kΩ	4.5	± 1.5%
POSCAP and Ceramic MLCC Output Capacitors Base capacitance = 4 x 330 µF (POSCAP) + 2 x 100 µF (Ceramic)	Base	3.740kΩ	1	± 5%
	1.5 x Base	4.220kΩ	1.5	
	2 x Base	4.750kΩ	2	± 3%
	2.5 x Base	5.360kΩ	2.5	
	3 x Base	6.040kΩ	3	± 1.5%
	3.5 x Base	6.810kΩ	3.5	
Reserved for User Programmed Compensation Values		7.680kΩ		
		8.660kΩ		
		9.530kΩ		
		10.500kΩ		
		11.800kΩ		
		13.000kΩ		
		14.300kΩ		
		15.800kΩ		
		17.400kΩ		
		19.100kΩ		
		21.000 kΩ		
	23.200 kΩ			

Table 12: RTUNE configuration table for EM2120H01

Compensator Description	C <sub>OUT</sub>	RTUNE Resistor	Multiplication factor (M)	Typical Deviation With 10A Load Step
Polymer Aluminum (SP-CAP) and Ceramic MLCC Output Capacitors Base capacitance = 2 x 220µF (Polymer) + 6 x 47µF	Base	0kΩ	1	± 3%
	2 x Base	0.392kΩ	2	
	2.5 x Base	0.576kΩ	2.5	
	3 x Base	0.787kΩ	3	
	3.5 x Base	1.000kΩ	3.5	
	4 x Base	1.240kΩ	4	
All MLCC Ceramic Output Capacitors Base capacitance = 10 x 100µF	Base	1.500kΩ	1	± 3%
	1.5 x Base	1.780kΩ	1.5	
	2 x Base	2.100kΩ	2	
	2.5 x Base	2.430kΩ	2.5	
	3 x Base	2.800kΩ	3	
	3.5 x Base	3.240kΩ	3.5	
TANT-CAP and Ceramic MLCC Output Capacitors Base capacitance = 1 x 470µF (TANT) + 2 x 100µF (Ceramic) + 2 x 47µF (Ceramic)	Base	3.740kΩ	1	
	2 x Base	4.220kΩ	2	± 3%
	2.5 x Base	4.750kΩ	2.5	
	3 x Base	5.360kΩ	3	
	3.5 x Base	6.040kΩ	3.5	
	4 x Base	6.810kΩ	4	
Reserved for User Programmed Compensation Values		7.680kΩ		
		8.660kΩ		
		9.530kΩ		
		10.500kΩ		
		11.800kΩ		
		13.000kΩ		
		14.300kΩ		
		15.800kΩ		
		17.400kΩ		
		19.100kΩ		
		21.000 kΩ		
	23.200 kΩ			

**Table 13: Recommended Output Capacitors**

Description	Manufacturer	P/N
470 $\mu$ F, 2.5V, ESR 3m $\Omega$ SP-CAP	Panasonic	EEFGX0E471R
470 $\mu$ F, 10V, ESR 50m $\Omega$ CAP-TANT ( <b>Note3</b> )	AVX Corp	TPSE477K010R0050
330 $\mu$ F, 6.3V, ESR 9 m $\Omega$ POSCAP	Panasonic	6TPF330M9L
220 $\mu$ F, 6.3V, ESR 5 m $\Omega$ POSCAP	Panasonic	6TPF220M5L
330 $\mu$ F, 2.5V, ESR 9 m $\Omega$ POSCAP	Kemet	T520B337M2R5ATE009
100 $\mu$ F, 6.3V, X5R, 1206 Ceramic	Kemet	C1206C107M9PACTU
100 $\mu$ F, 10V, X5R, 1206 Ceramic ( <b>Note3</b> )	TDK	C3216X5R1A107M
47 $\mu$ F, 6.3V, X5R 1206 Ceramic	Murata	GRM31CR60J476ME19L
47 $\mu$ F, 10V, X5R 1206 Ceramic ( <b>Note3</b> )	Kemet	C1206C476M8PACTU

**Note3:** These caps used for EM2120H01 Comp2 to support 5V out

## OUTPUT CAPACITOR RECOMMENDATION

EM2120 is designed for fast transient response and low output ripple noise. The output capacitors should be low ESR polymer, tantalum or ceramic capacitor. [Table 11](#) shows different output capacitor combinations to optimize the load transient deviation performance. With the Rtune feature, the user can simply scale up the total output capacitance to meet further stringent transient requirement.

Please consult the documentation for your particular FPGA, ASIC, processor, or memory block for the transient and the bulk decoupling capacitor requirements.

## INPUT CAPACITOR RECOMMENDATION

The EM2120 input should be decoupled with at least three 22 $\mu$ F 1206 case size and one 10 $\mu$ F 0805 case size MLCC ceramic capacitors or four 22 $\mu$ F MLCC 1206 case size ceramic capacitors. More bulk capacitor may be needed only if there are long inductive traces at the input source or there is not enough source capacitance.

These input decoupling ceramic capacitors can be mounted on the PCB back-side to reduce the solution size. These input filter capacitors should have the appropriate voltage rating for the input voltage on PVIN, and use a X5R, X7R, or equivalent dielectric rating. Y5V or equivalent dielectric formulations must not be used as these lose too much capacitance with frequency, temperature and bias voltage.

The PVCC pin provides power to the gate drive of the internal high/low side power MOSFETs. The VCC pin provides power to the internal digital controller. These two power inputs share the same supply voltage (5V nominal), and should be bypassed with a single 2.2 $\mu$ F MLCC capacitor. To avoid switching noise injection from PVCC to VCC, it is recommended a ferrite bead is inserted between PVCC and VCC pins as shown [Figure 16](#).

## PROTECTION FEATURES

The EM2120 offers a complete suite of programmable fault warnings and protections. Input and output Under Voltage Lock-Out (UVLO) and Over Voltage Lock-Out (OVLO) conditions are continuously monitored. A dedicated ADC is used to provide fast and accurate current information during the entire switching period to provide fast Over-Current Protection (OCP) response.

To prevent damage to the load, the EM2120 utilizes an output over-voltage protection circuit. The voltage at VSENP is continuously compared with a configurable threshold using a high-speed analog comparator. If the voltage exceeds the configured threshold, a fault response is generated and the PWM output is turned off.

The output voltage is also sampled, filtered, and compared with an output over-voltage warning threshold. If the output voltage exceeds this threshold, a warning is generated and the preconfigured actions are triggered. The EM2120 also monitors the output voltage with two lower thresholds. If the output voltage is below the under-voltage warning level and above the under-voltage fault level, an output voltage under-voltage warning is triggered. If the output voltage falls below the fault level, a fault event is generated.

Similar to output over and under voltage protection, the EM2120 monitors the input voltage at VINSEN continuously with a configurable threshold. If the input voltage exceeds the over voltage threshold or is below the under-voltage threshold, the default response is generated.

Over Temperature Protection (OTP) is based on direct monitoring of the device's internal temperature. If the temperature exceeds the OTP threshold, the device will enter a soft-stop mode slowly ramping the output voltage down until the temperature falls below the default recovery temperature.

The default fault response is zero delay and latch off for most fault conditions. The CTRL pin may be cycled to clear the latch. Table 14 summarizes the default configurations that have been pre-programmed to the device.

**Table 14: Fault Configuration Overview**

Signal	Fault Level	Default Response Type	Delay (ms)	Retries
Output Over-Voltage	Warning		0	None
	Fault	High-impedance		
Output Under-Voltage	Warning		0	None
	Fault	High-impedance		
Input Over-Voltage	Warning		0	None
	Fault	High-impedance		
Input Under-Voltage	Warning		0	Infinity
	Fault	High-impedance		
Over-Current	Warning		0	None
	Fault	High-impedance		
Internal Over-Temperature	Warning		0	Infinity
	Fault	Soft Off		

## FUNCTIONAL DESCRIPTION: ADVANCED CONFIGURATION

All EM2120 modules are delivered with a pre-programmed default configuration, allowing the module to be powered up without a need to configure the device or even the need for the GUI to be connected. However, a PMBus version 1.2 compliant interface allows access to an extensive suite of digital communication and control commands. This includes configuring the EM2120 for optimum performance, setting various parameters such as output voltage, and monitoring and reporting device behavior including output voltage, output current, and fault responses.

The device may be reconfigured multiple times without storing the configuration into the non-volatile memory (NVM). Any configuration changes will be lost upon power-on reset unless specifically stored into NVM using either STORE\_DEFAULT\_ALL or STORE\_DEFAULT\_CODE PMBus commands. Please see [Table 17](#) for more details.

For RVSET and RTUNE configurations, there is no reprogramming permitted.

After writing a new configuration to NVM, the user may still make changes to the device configuration through the PMBus interface; however, now upon power cycling the device, the stored NVM configuration will be recalled upon power-up rather than the factory default configuration of the EM2120.

The NVM configuration can be stored three times in its entirety. However, the consumption of the available NVM is dynamic, based on the configuration parameters that have actually changed. The unused NVM information is given in the GUI or through the manufacture specific command MFR\_STORE\_PARAMS\_REMAINING.

## INTEL DIGITAL POWER CONFIGURATOR

The Intel Enpirion Digital Power Configurator is a Graphical User Interface (GUI) software which allows the EM2120 to be controlled via a USB interface to a host computer.

The user can view the power supply's status, I/O voltages, output current and fault conditions detected by the device, program settings to the converter, and issue PMBus commands using the GUI. Most of the parameters (for example, VOUT turn on/off time, protection and fault limits) can be configured and adjusted within the GUI environment. These parameters can also be configured outside of the GUI environment using the relevant PMBus™ commands.

The GUI also allows the user to easily create, modify, test and save a configuration file which may then be used to permanently burn the configuration into NVM within a production test environment.

## ALTERNATIVE OUTPUT VOLTAGE CONTROL METHODS

In the default configuration, output voltage selection is determined at power-up by the pin-strapped resistor RVSET. This functionality can be disabled using the PMBus command MFR\_PIN\_CONFIG. When RVSET is disabled, the output voltage will be determined by the nominal output voltage setting in the user configuration. The EM2120 supports a subset of the output voltage commands outlined in the PMBus specification. For example, the output voltage can be dynamically changed using the PMBus command VOUT\_COMMAND. When the output is being changed by the PMBus command, power good (POK) remains at a logic high.

## POWER SEQUENCING AND THE CONTROL (CTRL) PIN

Three different configuration options are supported to enable the output voltage. The device can be configured to turn on after an OPERATION\_ON command, via the assertion of the CTRL pin or a combination of both per the PMBus convention. The EM2120 supports power sequencing features including programmable ramp up/down and delays. The typical sequence of events is shown in Figure 6 and follows the PMBus standard. The individual timing values shown in Figure 6 and Figure 8 can be configured using the appropriate configuration setting in Intel Digital Power Configurator GUI.

### PRE-BIASED START-UP AND SOFT-STOP

In systems with complex power architectures, there may be leakage paths from one supply domain which may charge capacitors in another supply domain, leading to a pre-biased condition on one or more power supplies. This condition is not ideal and can be avoided through careful design, but is generally not harmful. Attempting to discharge the pre-bias is not advised as it may force high current through the leakage path. The EM2120 includes features to enable and disable into pre-biased output capacitors.

If the output capacitors are pre-biased when the EM2120 is enabled, start-up logic in the EM2120 ensures that the output does not pull down the pre-biased voltage and the  $t_{ON\_RISE}$  timing is preserved. Closed-loop stability is ensured during the entire start-up sequence under all pre-bias conditions.

The EM2120 also supports pre-biased off, in which the output voltage ramp down to a user-defined level ( $V_{OFF\_nom}$ ) rather than to zero. After receiving the disable command, via PMBus command or the CTRL pin, the EM2120 ramps down the output voltage to the predefined value. Once the value is reached, the output driver goes into a tristate mode to avoid excessive currents through the leakage path.

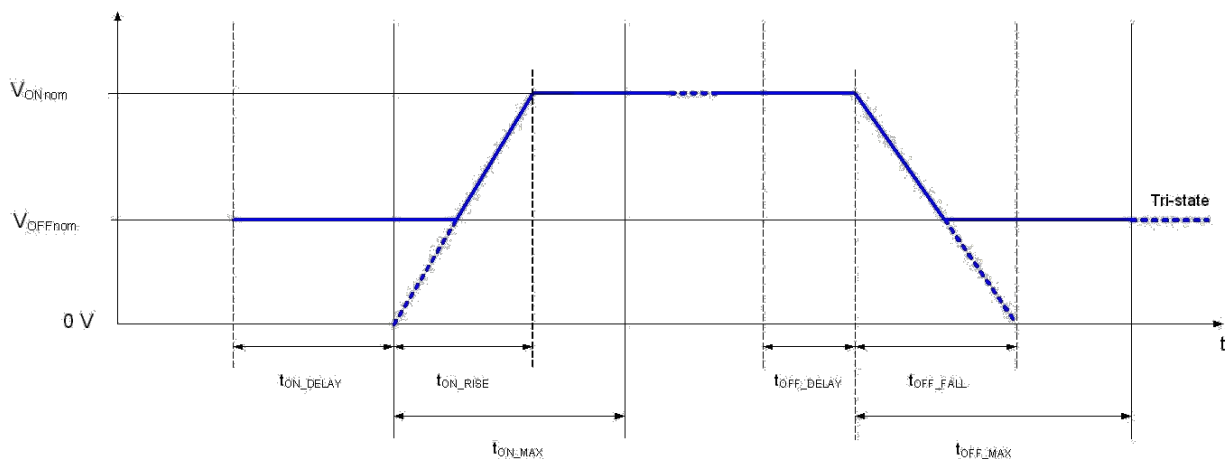
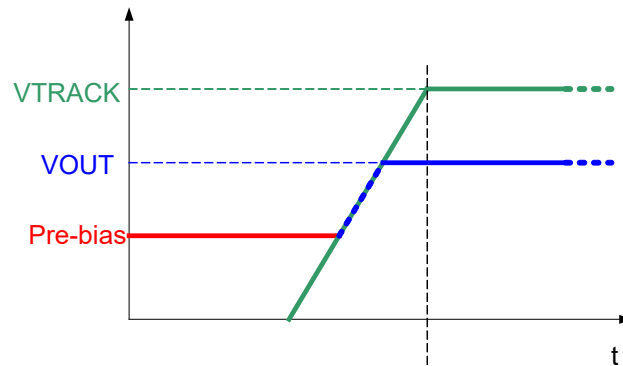

Figure 8: Power Sequencing With Non-Zero Off Voltage

### VOLTAGE TRACKING

The EM2120 can control the output voltage based on the external voltage applied to the VTRACK pin, thus allowing sequencing of the output voltage from an external source. Pre-bias situations are also supported. The VTRACK pin voltage is a single-ended input referenced to analog ground. Tracking mode is disabled by default, but it can be enabled using the GUI software or via the manufacturer-specific PMBus command, MFR\_FEATURES\_CTRL (see Table 17).

If VTRACK is not intended to be used, tie the VTRACK pin low or leave it floating.



**Figure 9: Power Sequencing Using VTRACK With Bias Voltage On VOUT**

The set point voltage for the EM2120 is defined by the lower value of the  $V_{OUT}$  setting or an external voltage applied to the VTRACK pin. If the VTRACK voltage rises above the  $V_{OUT}$  set point voltage, then the final output voltage will be limited by the  $V_{OUT}$  setting. If the tracking feature is enabled, but the VTRACK pin is tied low or floating, then the output will never start as the VTRACK pin input is always the lower value and will always be in control. Conversely, if tracking is enabled, but VTRACK is tied high, the output will start but will follow the  $V_{OUT}$  set point, not the VTRACK pin.

If tracking is used for sequencing, it is recommended that the VTRACK signal be kept greater than the  $V_{OUT}$  voltage. This ensures that the internal  $V_{OUT}$  set point is used as the final steady-state output voltage and accuracy is not a function of the externally applied VTRACK voltage. The tracking function will override a programmed pre-bias off level ( $V_{OFF\_nom}$ ).

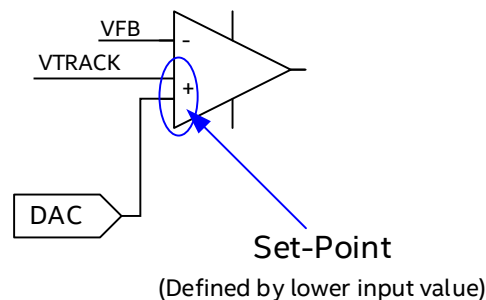

**Figure 10: VTRACK Circuitry**

The following figures demonstrate ratio-metric and simultaneous sequencing of the output voltage, which can be accomplished by applying an appropriate external voltage on the VTRACK pin. When using the VTRACK feature, the sequencing will be ratio-metric as shown in Figure 13. If an external resistor network is used at the VTRACK pin as shown in Figure 11. If no external resistors are used, the output sequence is simultaneous as shown in Figure 14.

In the event that a feedback divider is not required, (such as when  $V_{OUT} \leq 1.4V$ ) but the tracking voltage applied to VTRACK is greater than 1.4V, then a 2k $\Omega$  resistor is required in series with the VTRACK pin to minimize leakage current as shown in Figure 12.

In applications where a voltage divider is required on the output voltage, a voltage divider consisting of the same values is also required for the VTRACK pin.

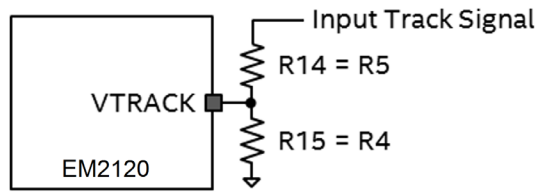

Figure 11: VTRACK Sense Circuitry with Resistor Divider

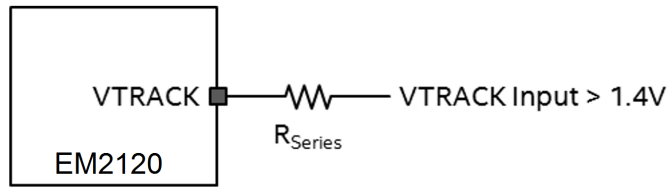

Figure 12: VTRACK Sense Circuitry (Input > 1.4V)

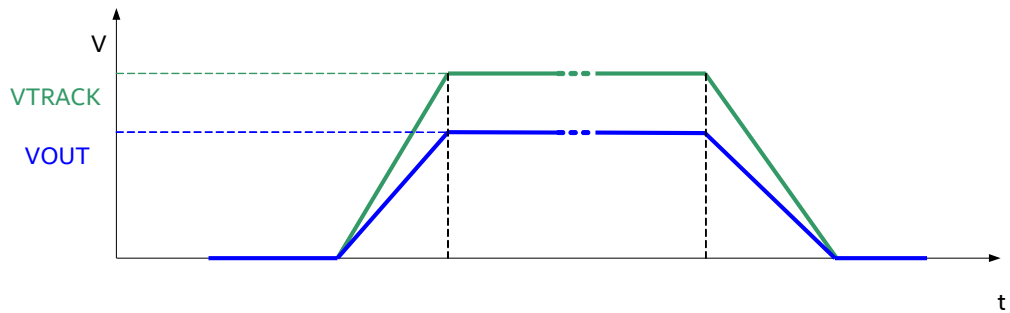

Figure 13: Ratiometric Sequencing Using VTRACK

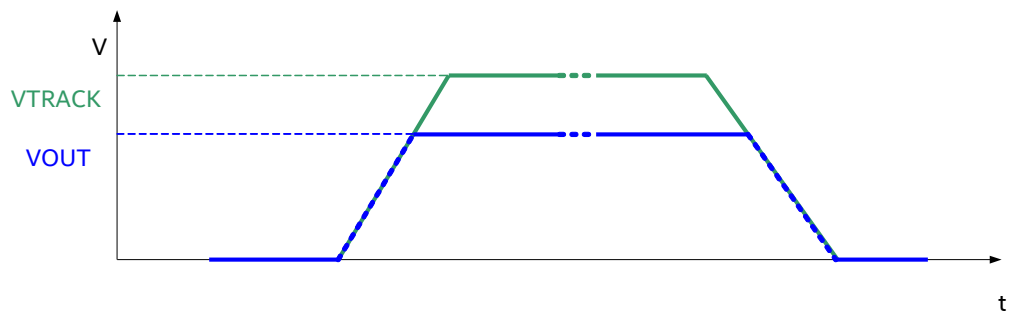

Figure 14: Simultaneous Sequencing Using VTRACK

## CLOCK SYNCHRONIZATION

The EM2120's PWM synchronization feature allows the user to synchronize the switching frequency of multiple devices. The SYNC pin can be configured as an input or an output.

When the SYNC pin is configured as input clock, the external clock need to be available before the EM2120 is enabled. The EM2120 will only lock to the external clock within 1ms after the device is enabled. After 1 ms the device can be re-synchronized to the external clock signal by toggling VOUT or via PMBus MFR\_RESYNC command.

When the SYNC pin is configured as an output clock (sync out), there is no requirement to provide an external clock to allow synchronization.

The EM2120 SYNC functionality maybe configured as an input or an output using Intel's GUI software or via the manufacturer-specific PMBus command, MFR\_PIN\_CONFIG. The default configuration for synchronization control is OFF.

## TEMPERATURE AND OUTPUT CURRENT MEASUREMENT

The EM2120 temperature sense block provides the device and the system with precision temperature information over a wide range of temperatures (-40°C to +150°C). The temperature sense block measures the digital controller temperature, which will be slightly lower than the powertrain junction temperature.

The EM2120 monitors output current by real-time, temperature compensated DCR current sensing across the inductor. This real-time current waveform is then digitally filtered and averaged for accurate telemetry, fault warning, and management.

Factory calibration has been performed for every EM2120 device to improve measurement accuracy over the full output current range. This allows the EM2120 to correct for DCR manufacturing variations.

For over-current protection, an unfiltered ADC is used in order to minimize delays in protecting the device. Because this measurement is unfiltered, the accuracy of the protection threshold is less than that of the average current reading.

## PROTECTION AND FAULT RESPONSE

The EM2120 monitors various signals during operation in order to detect fault conditions. Measured and filtered signals are compared to a configurable set of warnings and fault thresholds. In typical usage, a warning sets a status flag, but does not trigger a response; whereas a fault sets a status flag and generates a response. The assertion of the SMBALERT signal can be configured to individual application requirements.

The EM2120 supports a number of different response types depending on the fault detected.

In the default configuration, the EM2120 responds to an over temperature event by ramping down V<sub>OUT</sub> in a controlled manner at a slew rate defined by the T<sub>OFF\_FALL</sub> value. This response type is termed "Soft-Off". The final state of the output signals depends on the value selected for V<sub>OFFnom</sub>.

For all other faults the EM2120 will respond by immediately turning off both the top-side MOSFET and low-side MOSFET. This response type is termed "High-Impedance".

For each fault response, a delay and a retry setting can be configured. If the delay-to-fault value is set to non-zero, the EM2120 will not respond to a fault immediately. Instead it will delay the response by the configured

value and then reassesses the signal. If the fault remains present during the delay time, the appropriate response will be triggered. If the fault is no longer present, the previous detection will be disregarded.

If the delay-to-retry value is set to non-zero, the EM2120 will not attempt to restart immediately after fault detection. Instead it will delay the restart by the configured value. If the fault is still present when attempting to restart, the appropriate response will be triggered. If the fault is no longer present, the previous detection will be disregarded. If the delay-to-fault is a non-zero value, then the delay-to-retry value will be a factor of 100 times greater than the delay-to-fault value.

The retry setting, i.e. the number of EM2120 restarts after a fault event, can be configured. This number can be between zero and six. A setting of seven represents infinite retry operation. This setting is commonly known as “Hiccup Mode.”

## **Watchdog Timer**

General house-keeping operations are managed by an internal microcontroller (MCU). To ensure reliable MCU operation in all environments a watchdog timer has been incorporated. The purpose of the watchdog timer is to reset the MCU as a last resort in the unlikely event of it entering an unknown state.

In the exceptional event of a reset the MCU will shutdown the controller into a safe state and will then reload its memory, restarting the controller and output into its known good default operating condition.

## PMBus Functionality

### INTRODUCTION

The EM2120 supports the PMBus protocol (version 1.2) to enable the use of configuration, monitoring, and fault management features during run-time.

The PMBus host controller is connected to the EM2120 via the PMBus pins (SDA, SCL). A dedicated SMBALERT pin is provided to notify the host that new status information is present.

The EM2120 supports packet correction (PEC) according to the PMBus™ specification.

The EM2120 supports clock stretching according to the SMBus specification.

The EM2120 communications utilizes clock stretching as required and this requires the PMBus master to support clock stretching.

The EM2120 supports more than 60 PMBus commands in addition to several manufacturer specific commands related to output voltage, faults, telemetry, and more.

The EM2120 provides a PMBus set of synchronous communication lines, with serial clock input (SCL), serial data I/O (SDA), and serial alarm output (SALRT) pins.

The communication lines provide 3.6V-tolerance, 1.8V I/O compatibility and open-drain outputs (SDA, SCL and SALRT). The communication lines require external pull-up resistors; typical applications require pull-up resistors on each end of the communication lines (typically values of 10 kΩ each), connected to VDD33 or an alternative termination voltage. Please refer to the PMBus specification ([www.pmbus.org](http://www.pmbus.org)) for full details.

The EM2120 provides configurable behavior for the SALRT pin to allow users to determine which fault or warning conditions to communicate over the SALRT line. The default behavior of the controller ensures that any fault or warning results in the EM2120 SALRT pin going low; the alert behavior is enabled for all faults and warnings. You can deselect any of the faults or warnings so when one of these conditions occur, the SALRT pin is not pulled low.

The EM2120 provides a PMBus compliant power conversion control signal through input CTRL. You can configure input CTRL through the standard PMBus command ON\_OFF\_CONFIG.

By default configuration, the CTRL pin must be pulled high to enable operation and the PMBus command OPERATION is ignored. You can override this function with the ON\_OFF\_CONFIG PMBus command.

Remote measurement and reporting of telemetry information at the power supply level provides feedback on key parameters such as voltages, current levels, temperature, and energy, and allows reporting of information such as faults and warning flags. With this information, data is collected and analyzed while the power supply is in development, such as in the qualification or verification phases, or in the field, and system level interaction such as power capping is implemented. Several telemetry parameters are supported by standard PMBus commands.

The EM2120 supports PMBus output current telemetry through the READ\_IOUT command and reports the low-pass filtered, or DC, output current.

The standard PMBus command READ\_VOUT supports output voltage telemetry.

The standard PMBus command READ\_VIN supports input voltage telemetry.

The EM2120 supports temperature telemetry and reporting through standardized PMBus commands. READ\_TEMPERATURE\_2 is mapped to the controller die temperature.

The standard PMBus command READ\_FREQUENCY supports switching frequency monitoring. This command returns the scaled frequency of the PWM output in kHz.

The EM2120 supports the LINEAR data format according to the PMBus specification. Note that in accordance with the PMBus specification, all commands related to the output voltage are subject to the VOUT\_MODE settings.

A detailed description of the supported PMBus commands supported by the EM2120 can be found in EM21xx Application Note – PMBus Commands Guide.

### TIMING AND BUS SPECIFICATION

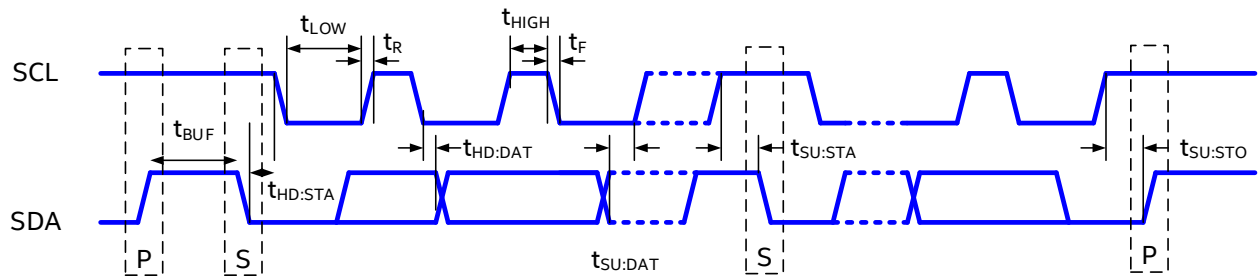

Figure 15: PMBus Timing Diagram

Table 15: EM2120 PMBus Parameters

Parameter	Symbol	Conditions	Min	Typ	Max	Units
PMBus operation frequency	$f_{SMB}$		10	100	400	kHz
Bus free time between start and stop	$t_{BUF}$		1.3			$\mu s$
Hold time after start condition	$t_{HD:STA}$		0.6			$\mu s$
Repeat start condition setup time	$t_{SU:STA}$		0.6			$\mu s$
Stop condition setup time	$t_{SU:STO}$		0.6			$\mu s$
Data hold time	$t_{HD:DAT}$		300			ns
Data setup time	$t_{SU:DAT}$		150*			ns
Clock low time-out	$t_{TIMEOUT}$			25	35	ms
Clock low period	$t_{LOW}$		1.3			$\mu s$
Clock high period	$t_{HIGH}$		0.6			$\mu s$
Cumulative clock low extend time	$t_{LOW:SEXT}$				25	ms
Clock or data fall time	$t_F$				300	ns
Clock or data rise time	$t_R$				300	ns

Note: The EM2120 fully complies with PMBus 1.2 specifications for operation up to 100kHz on SCL. The EM2120 may be operated at frequencies up to at least 400kHz on SCL if  $t_{SU:DAT}$  is maintained greater than 150ns.

## ADDRESS SELECTION VIA EXTERNAL RESISTORS

The PMBus protocol uses a 7-bit device address to identify different devices connected to the bus. This address can be selected via external resistors connected to the ADDR<sub>x</sub> pins.

The resistor values are sensed using the internal ADC during the initialization phase and the appropriate PMBus address is selected. Note that the respective circuitry is only active during the initialization phase; hence no DC voltage can be measured at the pins. The supported PMBus addresses and the values of the respective required resistors are listed in [Table 16](#).

**Table 16: Supported Resistor Values For PMBus Address Selection**

Address (hex)	ADDR1 Ω	ADDR0 Ω	Address (hex)	ADDR1 Ω	ADDR0 Ω	Address (hex)	ADDR1 Ω	ADDR0 Ω
0x40	0	0	0x2B	1.2 k	12 k	0x56	3.9 k	4.7 k
0x01*	0	680	0x2C	1.2 k	15 k	0x57	3.9 k	5.6 k
0x02*	0	1.2 k	0x2D	1.2 k	18 k	0x58	3.9 k	6.8 k
0x03*	0	1.8 k	0x2E	1.2 k	22 k	0x59	3.9 k	8.2 k
0x04*	0	2.7 k	0x2F	1.2 k	27 k	0x5A	3.9 k	10 k
0x05*	0	3.9 k	0x30	1.8 k	0	0x5B	3.9 k	12 k
0x06*	0	4.7 k	0x31	1.8 k	680	0x5C	3.9 k	15 k
0x07*	0	5.6 k	0x32	1.8 k	1.2 k	0x5D	3.9 k	18 k
0x08*	0	6.8 k	0x33	1.8 k	1.8 k	0x5E	3.9 k	22 k
0x09	0	8.2 k	0x34	1.8 k	2.7 k	0x5F	3.9 k	27 k
0x0A	0	10 k	0x35	1.8 k	3.9 k	0x60	4.7 k	0
0x0B	0	12 k	0x36	1.8 k	4.7 k	0x61*	4.7 k	680
0x0C*	0	15 k	0x37*	1.8 k	5.6 k	0x62	4.7 k	1.2 k
0x0D	0	18 k	0x38	1.8 k	6.8 k	0x63	4.7 k	1.8 k
0x0E	0	22 k	0x39	1.8 k	8.2 k	0x64	4.7 k	2.7 k
0x0F	0	27 k	0x3A	1.8 k	10 k	0x65	4.7 k	3.9 k
0x10	680	0	0x3B	1.8 k	12 k	0x66	4.7 k	4.7 k
0x11	680	680	0x3C	1.8 k	15 k	0x67	4.7 k	5.6 k
0x12	680	1.2 k	0x3D	1.8 k	18 k	0x68	4.7 k	6.8 k
0x13	680	1.8 k	0x3E	1.8 k	22 k	0x69	4.7 k	8.2 k
0x14	680	2.7 k	0x3F	1.8 k	27 k	0x6A	4.7 k	10 k
0x15	680	3.9 k	0x40	2.7 k	0	0x6B	4.7 k	12 k
0x16	680	4.7 k	0x41	2.7 k	680	0x6C	4.7 k	15 k
0x17	680	5.6 k	0x42	2.7 k	1.2 k	0x6D	4.7 k	18 k
0x18	680	6.8 k	0x43	2.7 k	1.8 k	0x6E	4.7 k	22 k
0x19	680	8.2 k	0x44	2.7 k	2.7 k	0x6F	4.7 k	27 k

Address (hex)	ADDR1 $\Omega$	ADDR0 $\Omega$	Address (hex)	ADDR1 $\Omega$	ADDR0 $\Omega$	Address (hex)	ADDR1 $\Omega$	ADDR0 $\Omega$
0x1A	680	10 k	0x45	2.7 k	3.9 k	0x70	5.6 k	0
0x1B	680	12 k	0x46	2.7 k	4.7 k	0x71	5.6 k	680
0x1C	680	15 k	0x47	2.7 k	5.6 k	0x72	5.6 k	1.2 k
0x1D	680	18 k	0x48	2.7 k	6.8 k	0x73	5.6 k	1.8 k
0x1E	680	22 k	0x49	2.7 k	8.2 k	0x74	5.6 k	2.7 k
0x1F	680	27 k	0x4A	2.7 k	10 k	0x75	5.6 k	3.9 k
0x20	1.2 k	0	0x4B	2.7 k	12 k	0x76	5.6 k	4.7 k
0x21	1.2 k	680	0x4C	2.7 k	15 k	0x77	5.6 k	5.6 k
0x22	1.2 k	1.2 k	0x4D	2.7 k	18 k	0x78*	5.6 k	6.8 k
0x23	1.2 k	1.8 k	0x4E	2.7 k	22 k	0x79*	5.6 k	8.2 k
0x24	1.2 k	2.7 k	0x4F	2.7 k	27 k	0x7A*	5.6 k	10 k
0x25	1.2 k	3.9 k	0x50	3.9 k	0	0x7B*	5.6 k	12 k
0x26	1.2 k	4.7 k	0x51	3.9 k	680	0x7C*	5.6 k	15 k
0x27	1.2 k	5.6 k	0x52	3.9 k	1.2 k	0x7D*	5.6 k	18 k
0x28*	1.2 k	6.8 k	0x53	3.9 k	1.8 k	0x7E*	5.6 k	22 k
0x29	1.2 k	8.2 k	0x54	3.9 k	2.7 k	0x7F*	5.6 k	27 k
0x2A	1.2 k	10 k	0x55	3.9 k	3.9 k			

**Note2:** The gray-highlighted addresses with an asterisks are reserved by the SMBus specification.

## PMBUS COMMANDS

A detailed description of the PMBus commands supported by the EM2120 can be found in a separate document - *EM2120 PMBus Commands Guide*. Below, Table 16 lists of all supported PMBus commands.

**Table 17: List Of Supported PMBus Commands**

Command Code	PMBus Parameter	Description
01 <sub>HEX</sub>	<b>OPERATION</b>	On/off command
02 <sub>HEX</sub>	<b>ON_OFF_CONFIG</b>	On/off configuration
03 <sub>HEX</sub>	<b>CLEAR_FAULTS</b>	Clear status information
10 <sub>HEX</sub>	<b>WRITE_PROTECT</b>	Protect against changes
11 <sub>HEX</sub>	<b>STORE_DEFAULT_ALL</b>	Copy entire memory into OTP
12 <sub>HEX</sub>	<b>RESTORE_DEFAULT_ALL</b>	Copy entire memory from OTP
13 <sub>HEX</sub>	<b>STORE_DEFAULT_CODE</b>	Copy single parameter into OTP
14 <sub>HEX</sub>	<b>RESTORE_DEFAULT_CODE</b>	Copy single parameter from OTP

Command Code	PMBus Parameter	Description
20 <sub>HEX</sub>	<b>VOUT_MODE</b> (Note4)	Exponent of the VOUT_COMMAND value
21 <sub>HEX</sub>	<b>VOUT_COMMAND</b>	Set output voltage
22 <sub>HEX</sub>	<b>VOUT_TRIM</b>	Apply a fixed offset voltage
23 <sub>HEX</sub>	<b>VOUT_CAL_OFFSET</b>	Apply a fixed offset voltage
25 <sub>HEX</sub>	<b>VOUT_MARGIN_HIGH</b>	Sets maximum value
26 <sub>HEX</sub>	<b>VOUT_MARGIN_LOW</b>	Sets minimum value
29 <sub>HEX</sub>	<b>VOUT_SCALE_LOOP</b>	Scalar for output voltage divider
2A <sub>HEX</sub>	<b>VOUT_SCALE_MONITOR</b>	Scalar for read-back with output voltage divider
35 <sub>HEX</sub>	<b>VIN_ON</b>	Input voltage turn on threshold
36 <sub>HEX</sub>	<b>VIN_OFF</b>	Input voltage turn off threshold
40 <sub>HEX</sub>	<b>VOUT_OV_FAULT_LIMIT</b>	Over-voltage fault limit
41 <sub>HEX</sub>	<b>VOUT_OV_FAULT_RESPONSE</b>	Over-voltage fault response
42 <sub>HEX</sub>	<b>VOUT_OV_WARN_LIMIT</b>	Over-voltage warning level
43 <sub>HEX</sub>	<b>VOUT_UV_WARN_LIMIT</b>	Under-voltage warning level
44 <sub>HEX</sub>	<b>VOUT_UV_FAULT_LIMIT</b>	Under-voltage fault level
45 <sub>HEX</sub>	<b>VOUT_UV_FAULT_RESPONSE</b>	Under-voltage fault response
55 <sub>HEX</sub>	<b>VIN_OV_FAULT_LIMIT</b>	Over-voltage fault limit
56 <sub>HEX</sub>	<b>VIN_OV_FAULT_RESPONSE</b>	Over-voltage fault response
57 <sub>HEX</sub>	<b>VIN_OV_WARN_LIMIT</b>	Over-voltage warning level
58 <sub>HEX</sub>	<b>VIN_UV_WARN_LIMIT</b>	Under-voltage warning level
59 <sub>HEX</sub>	<b>VIN_UV_FAULT_LIMIT</b>	Under-voltage fault level
5A <sub>HEX</sub>	<b>VIN_UV_FAULT_RESPONSE</b>	Under-voltage fault response
5E <sub>HEX</sub>	<b>POWER_GOOD_ON</b>	Power good on threshold
5F <sub>HEX</sub>	<b>POWER_GOOD_OFF</b>	Power good off threshold
60 <sub>HEX</sub>	<b>TON_DELAY</b>	Turn-on delay
61 <sub>HEX</sub>	<b>TON_RISE</b>	Turn-on rise time
62 <sub>HEX</sub>	<b>TON_MAX_FAULT_LIMIT</b>	Turn-on maximum fault time
64 <sub>HEX</sub>	<b>TOFF_DELAY</b>	Turn-off delay
65 <sub>HEX</sub>	<b>TOFF_FALL</b>	Turn-off fall time
66 <sub>HEX</sub>	<b>TOFF_MAX_WARN_LIMIT</b>	Turn-off maximum warning time
78 <sub>HEX</sub>	<b>STATUS_BYTE</b>	Unit status byte
79 <sub>HEX</sub>	<b>STATUS_WORD</b>	Unit status word

Command Code	PMBus Parameter	Description
7A <sub>HEX</sub>	<b>STATUS_VOUT</b>	Output voltage status
7B <sub>HEX</sub>	<b>STATUS_IOUT</b>	Output current status
7C <sub>HEX</sub>	<b>STATUS_INPUT</b>	Input status
7E <sub>HEX</sub>	<b>STATUS_CML</b>	Communication and memory status
80 <sub>HEX</sub>	<b>STATUS_MFR_SPECIFIC</b>	Manufacturer specific status
88 <sub>HEX</sub>	<b>READ_VIN</b>	Reads input voltage
8B <sub>HEX</sub>	<b>READ_VOUT</b>	Reads output voltage
8C <sub>HEX</sub>	<b>READ_IOUT</b>	Reads output current
8E <sub>HEX</sub>	<b>READ_TEMPERATURE</b>	Reads temperature
95 <sub>HEX</sub>	<b>READ_FREQUENCY</b>	Reads switching frequency
96 <sub>HEX</sub>	<b>READ_POUT</b>	Reads output power
98 <sub>HEX</sub>	<b>PMBUS™_REVISION</b>	PMBus™ revision
99 <sub>HEX</sub>	<b>MFR_ID</b>	Manufacturer ID
9A <sub>HEX</sub>	<b>MFR_MODEL</b>	Manufacturer model identifier
9B <sub>HEX</sub>	<b>MFR_REVISION</b>	Manufacturer product revision
9E <sub>HEX</sub>	<b>MFR_SERIAL</b>	Serial number
A0 <sub>HEX</sub>	<b>MFR_VIN_MIN</b>	Minimum input voltage
A4 <sub>HEX</sub>	<b>MFR_VOUT_MIN</b>	Minimum output voltage
D0 <sub>HEX</sub>	<b>MFR_SPECIFIC_00</b>	Write word (once) / Read word – 2 bytes
D1 <sub>HEX</sub>	<b>MFR_SPECIFIC_01</b>	Write word / read word – 12 bytes
D2 <sub>HEX</sub>	<b>MFR_READ_VCC</b>	Reads VCC voltage
D3 <sub>HEX</sub>	<b>MFR_RESYNC</b>	Active RESYNC
DA <sub>HEX</sub>	<b>MFR_RTUNE_CONFIG</b>	Gets/sets RTUNE settings
DB <sub>HEX</sub>	<b>MFR_VOUT_MARGIN_HIGH</b>	Gets/sets Margin High
DC <sub>HEX</sub>	<b>MFR_VOUT_MARGIN_LOW</b>	Gets/sets Margin Low
DD <sub>HEX</sub>	<b>MFR_RTUNE_INDEX</b>	Returns index derived from resistor detected on RTUNE pin
DE <sub>HEX</sub>	<b>MFR_RVSET_INDEX</b>	Returns index derived from resistor detected on RVSET pin
E0 <sub>HEX</sub>	<b>MFR_VOUT_OFF</b>	Sets the target turn-off voltage
E2 <sub>HEX</sub>	<b>MFR_OT_FAULT_LIMIT</b>	Over-temperature fault level
E3 <sub>HEX</sub>	<b>MFR_OT_WARN_LIMIT</b>	Over-temperature warning level
E5 <sub>HEX</sub>	<b>MFR_OT_FAULT_RESPONSE</b>	Over-temperature fault response

Command Code	PMBus Parameter	Description
E6 <sub>HEX</sub>	<b>MFR_TEMP_ON</b>	Over-temperature on level
E7 <sub>HEX</sub>	<b>MFR_PIN_CONFIG</b>	Enable/disable – RTUNE, RVSET, VTRACK and SYNC
E9 <sub>HEX</sub>	<b>MFR_STORE_CONFIG_ADDR_READ</b>	Reads a configuration value
EA <sub>HEX</sub>	<b>MFR_STORE_PARAMS_REMAINING</b>	Number of STORE_DEFAULT_ALL commands remaining
EB <sub>HEX</sub>	<b>MFR_STORE_CONFIGS_REMAINING</b>	Number of full configurations remaining
EC <sub>HEX</sub>	<b>MFR_STORE_CONFIG_BEGIN</b>	Commence programming of OTP
ED <sub>HEX</sub>	<b>MFR_STORE_CONFIG_ADDR_DATA</b>	Program a configuration value
EE <sub>HEX</sub>	<b>MFR_STORE_CONFIG_END</b>	Completed programming of OTP

**Note4:** VOUT\_ MODE is read only for the EM2120

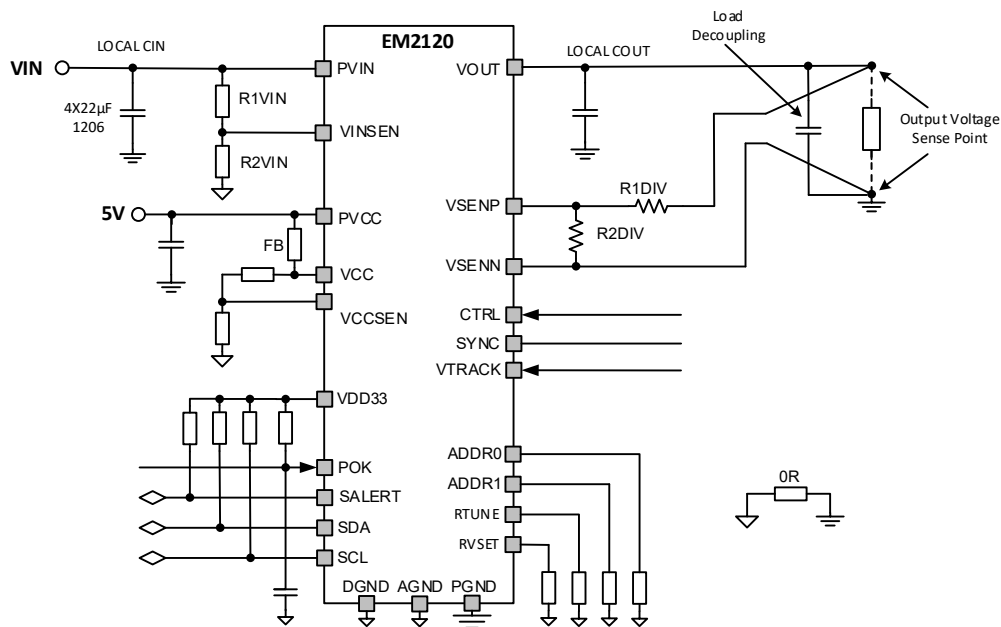
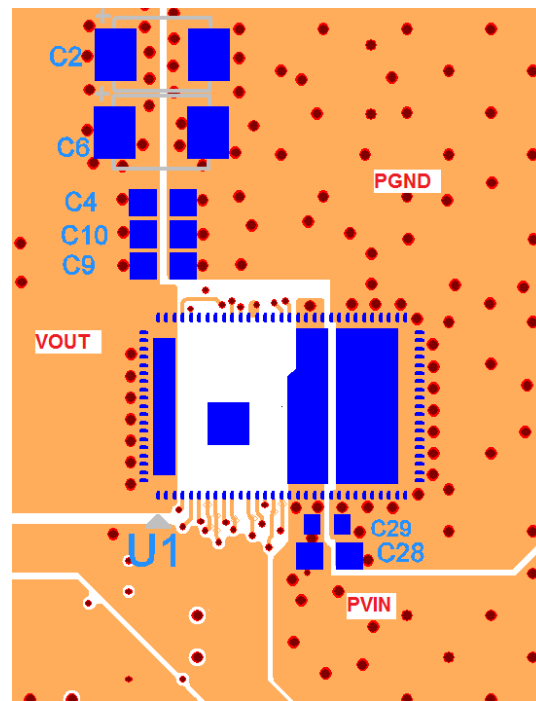

**Figure 16: Recommended Application Circuit**

## Layout Recommendations

**Recommendation 1:** It is highly recommended to use separate nets for AGND and PGND and connecting them through a 0Ω resistor or a short. This method helps with ground management and prevents the noise from the Power Ground disturbing the more sensitive Analog (“Signal”) Ground.

**Recommendation 2:** It is good practice to minimize the PGND loop. Whenever possible the input and output loops should close to the same point, which is the ground of the EM2120 module. Module decoupling ceramic capacitors are to be placed as close as possible to the module in order to contain the switching noise in the smallest possible loops and to improve PVIN decoupling by minimizing the series parasitic inductance of the PVIN traces. For achieving this goal, it helps to place decoupling capacitors on the same side as the module since VIAs are generally more inductive, thus reducing the effectiveness of the decoupling. Of course, bulk and load high frequency decoupling should be placed closer to the load.



**Figure 17: Top Layer Layout With Critical Components Only**

**Recommendation 3:** It is good practice to place the other small components needed by the EM2120 on the opposite side of the board, in order to avoid cutting the power planes on the module side. Since the EM2120 heat is evacuated mostly through the PCB, this will also help with heat dissipation; wide copper planes under the module can also help with cooling. The PVIN copper plane should not be neglected as it helps spread the heat from the high side FET.

**Recommendation 4:** It is recommended that at least below the EM2120 module, the next layers to the surface (2 and n-1) be solid ground planes, which provides shielding and lower the ground impedance at the module level. AGND should be also routed as a copper plane, in order to reduce the ground impedance and reduce noise injection.

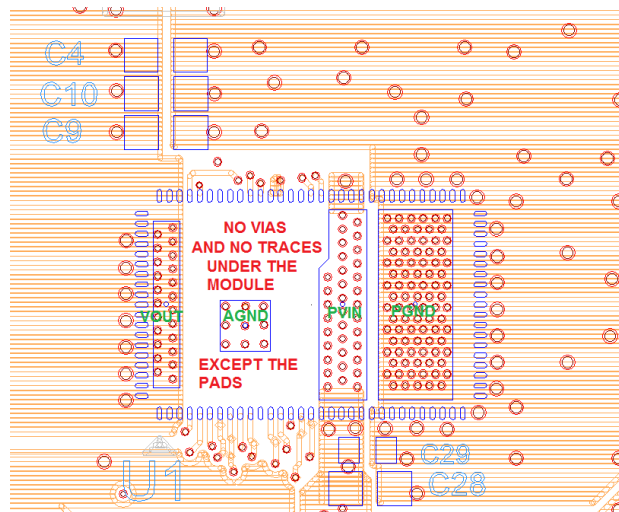

**Figure 18: VIAs in The Power Pads**

**Recommendation 5:** In order to better spread the current and the heat through the inner layers, arrays of VIAs should be placed in the power pads. 10mils diameter is a good size for the plated in-pad VIAs. It is critical that through VIAs should not be placed by any means elsewhere under the module; the non-pad area around AGND is VIA keep out area.

**Recommendation 6:** All other signal and LDO decoupling capacitors should be placed as close as possible to the terminal they are decoupling, while the AGND connection should be done through VIAs to the AGND plane.

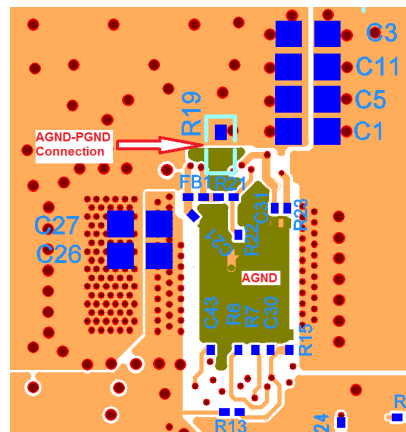
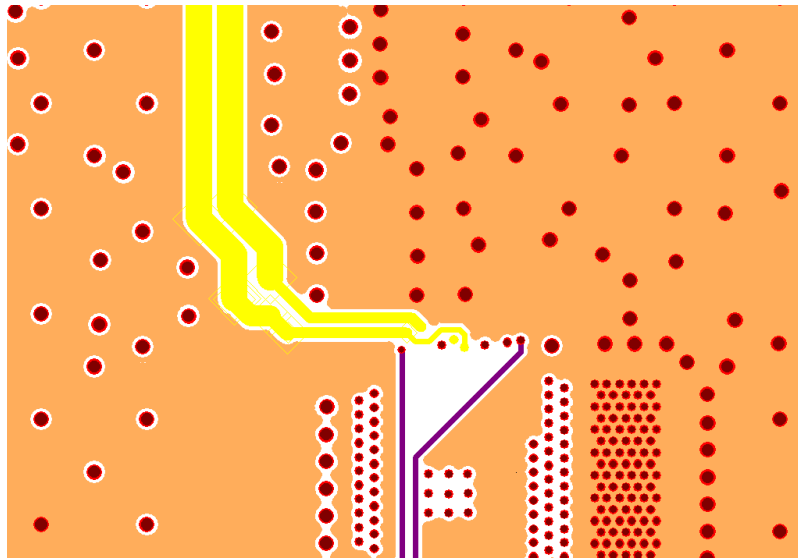

**Figure 19: Backside Decoupling**

**All Signal Decoupling Go To The Bottom AGND Plane And Get Connected To The EM2120 Module AGND Through The AGND In-PAD VIAs (Again, No Other VIAs Are Allowed In That Area)**

**Recommendation 7:** Figure 20 also shows the 0Ω resistor that connects AGND to PGND. The recommended connecting point, as shown, is to a quiet PGND → the output capacitors PGND.

**Recommendation 8:** Differential remote sense should be routed as much as possible as a differential pair, on an inner layer, preferably shielded by a ground plane.



**Figure 20: Remote Sense Routing On An Inner Layer (Highlighted, Yellow)**

**Recommendation 9:** If the design allows it, stitching VIAs can be used on the power planes, close to the module in order to help with cooling. This is a thermal consideration and does not matter much for the electrical design.

## Recommended PCB Footprint

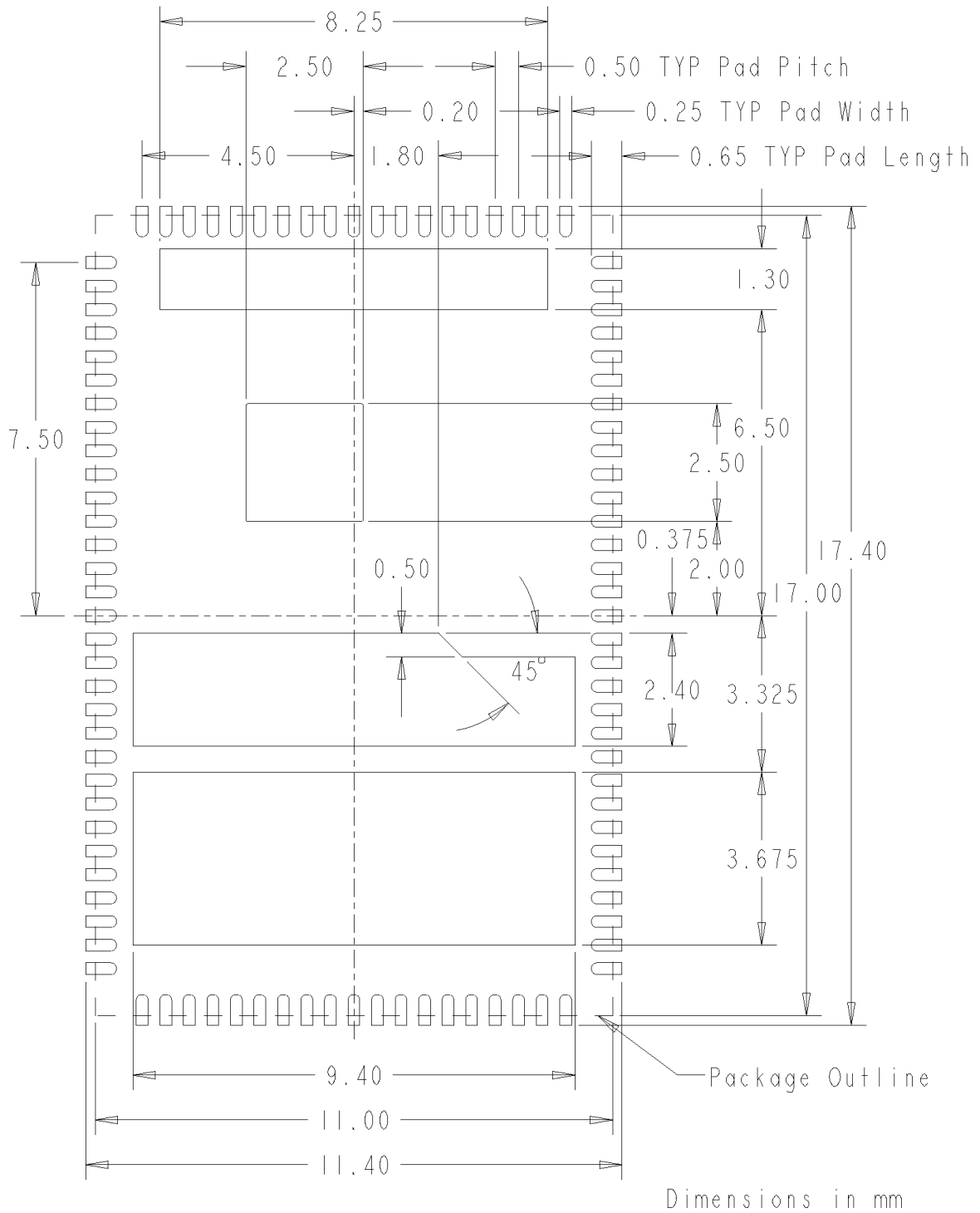

**Figure 21: Recommended PCB Footprint**



## Package Dimensions

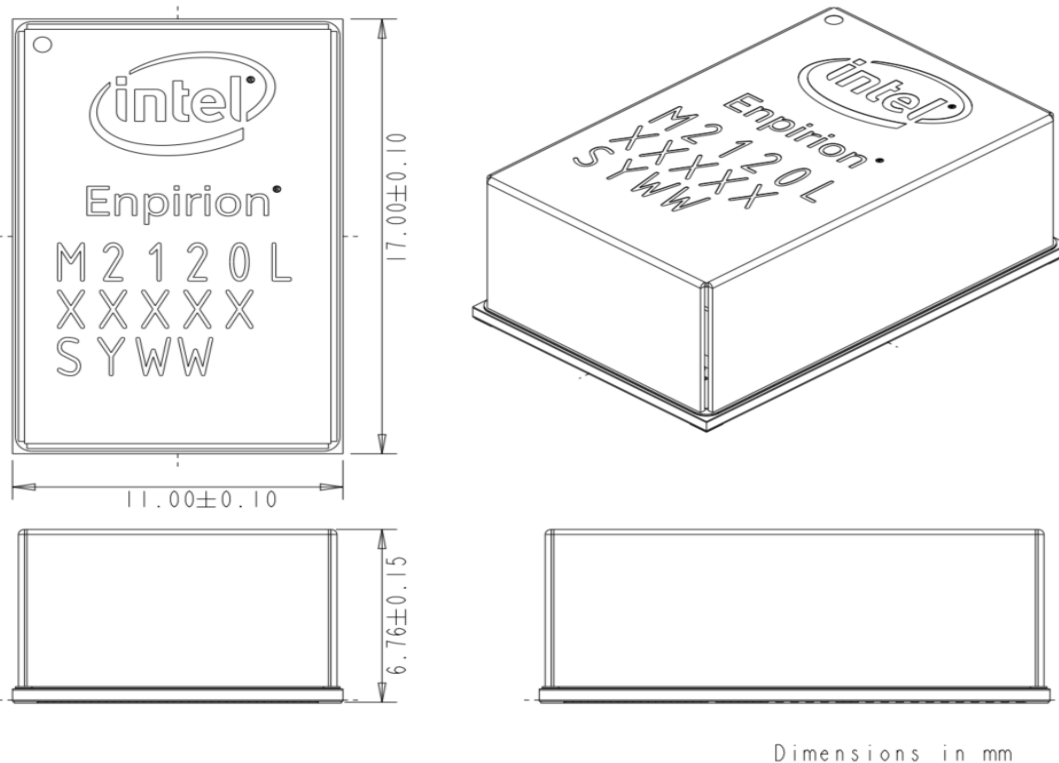
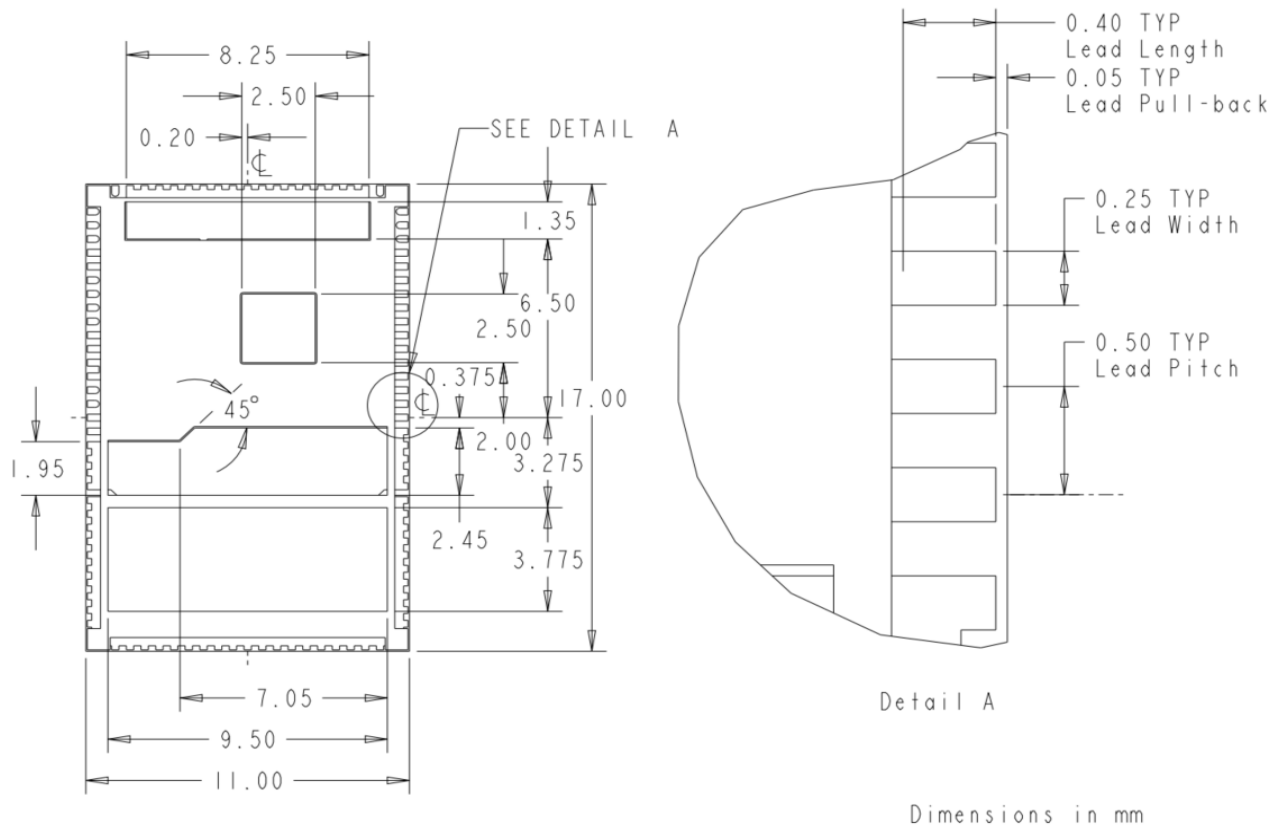

Figure 23: Package Dimensions



# Tray Information (Continued)

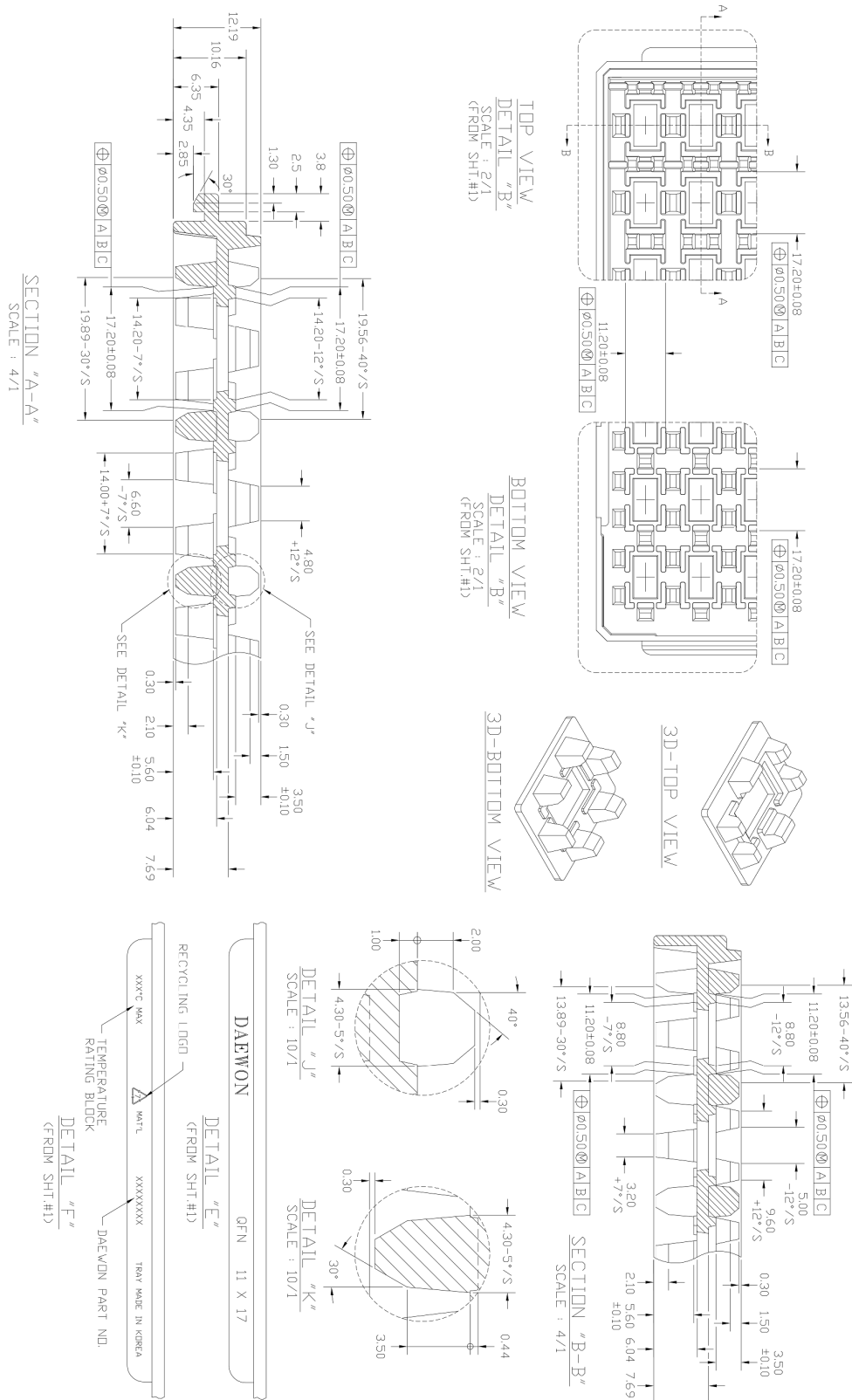

Figure 25: Tray Information 2/2

## Revision History

Rev	Date	Change(s)
A	Mar - 17	Initial Release
B	May - 17	Added Rtune table for EM2120H Removed old Table 12 and Figure 7, updated the Output Capacitor Recommendation section. Updated for new POK functionality.
C	Sept - 17	Updated RVSET Table Corrected some text errors
D	Nov - 17	Updated POK description Corrected some text errors
E	Jun - 18	No Change
F	Jun - 18	Updated POK description, PMBus Introduction and note on Watchdog Timer
G	Jul - 18	Added the solder stencil options for 30% & 45% opening
H	Mar - 20	Added information relating to SMBALERT, removed stencil option for 45% opening

## Where to Get More Information

For more information about Intel and Intel Enpirion PowerSoCs, visit <https://www.altera.com/enpirion>

## Looking for pricing, stock, or lifecycle information?

Click below to explore more details on WIN SOURCE:

 [View EM2120H01QI on WIN SOURCE](#)

 [Intel Information](#)

## Optimize Your Supply Chain with WIN SOURCE Solutions

-  Global Sourcing Solution
-  Obsolete Management
-  Cost Control Management
-  Shortage Management
-  Alternative Solution
-  Excess Inventory Management