



**THE DATASHEET OF
SFD1200-12BG**





Features

- RoHS compliant for all six substances
- Wide DC input range (-40 to -75 VDC)
- 1U or 2U height configurations
- Active current share with ORing FET on +12V
- I²C interface status and control
- Standby voltage of 3.3 VDC @ 3 A
- Overtemperature, overload, and overvoltage protection
- Variable-speed fan for low noise at low ambient temperatures
- Status LEDs: INPUT OK, OUTPUT OK, and FAULT

Applications

- Datacom
- Distributed power systems
- Servers

Description

The SFD1200-12BG is a 1200-watt, DC-input front-end which has a main 12 VDC output for datacom, distributed power, and server applications, and provides a 3.3 VDC standby output. Its compact size enables mounting in both 1U and 2U height racks. High efficiencies, advanced thermal management techniques, and an internal fan increase reliability over a broad range of operating conditions. Internal ORing FETs facilitate use in hot-swap, redundant configurations.

Status is provided with front panel LEDs, logic signals, and via an I²C management interface bus. In addition, the I²C bus can supply status information about the power supply including output current and voltage.

The SFD1200-12G meets international safety requirements for ITE and is CE marked to the Low Voltage Directive (LVD).

Model Selection

Model	Nominal Output Voltage (VDC)	Adjustment Range (VDC)	Minimum Load (A)	Maximum Output Current (Amps)	Regulation %	Ripple & Noise @ 20 MHz BW (mV)
SFD1200-12BG	12	N/A	0.5	99.2	±3	100
	3.35 (Standby)	N/A	0	3	±3	100

Input Specifications

Parameter	Conditions/Description	Min.	Nom.	Max.	Units
DC Input Voltage	Continuous input range.	-40	-53	-75	VDC
Hold-up Time	On all outputs. @ -53 VDC		5		ms
Input Current	At full-rated load. @ -40 VDC		35		A
Inrush Surge Current	Excluding Xcap. @ 25 °C		35		A pk

Output Specifications

Parameter	Conditions/Description	Min.	Nom.	Max.	Units
Efficiency NOTE: Internal fan is considered part of the load as it is driven from the 12V output; Vaux load is set to 0.5A for efficiency measurements.	With Vin at -40 VDC and 50% to 75% load on V1.		90		%
	With Vin at -40 VDC and 75% to 100% load on V1.		90		%
	With Vin at -70 VDC and 50% to 75% load on V1.		91		%
	With Vin at -70 VDC and 75% to 100% load on V1.		91		%
Minimum Load	Minimum loading required to maintain regulation.	0.5			A
Output Power	Input of -40 to -75 VDC:			1200	W
Overshoot	Output voltage overshoot at turn-on. Overshoot lasts <5 ms.			< 5	%
Transient Response	Maximum recovery time to within 1% of initial set point due to a 25% load change, 1A/μs. 12V output: Standby output:			5	ms
				5	ms
	Maximum deviation: 12V output: Standby output:			3	%
				3	%
Turn-On Delay with PS_ON signal	Time required for initial output voltage stabilization after application of DC input or ON/OFF signal.			3000	ms
Output Regulation	See Model Selection data on page 1.				

Interface Signals and Internal Protection¹

Parameter	Conditions/Description	Min.	Nom.	Max.	Units
Overvoltage Protection	Latch-style overvoltage protection. 12V output: Standby output:			15 4.3	V
Overcurrent Protection	Slow Current limit 12V output: Overcurrent (Latching Mode). 12V output: Standby output:	104 116 4		115 130 6	A
Short-Circuit Protection	Latching Mode.				
Overtemperature/ Fan Failure Warning	12V output will shut down in the event of an overtemperature condition or blocked fan rotor. OT setpoint is 55 ±5 °C. Supply's fan and Vaux are active. Power supply will recover when OT condition is removed. Amber OT LED will turn ON to indicate fault condition.				
PS_ON	Output enable. Pulled low allows V1 to be activated.				
+12V Current Share	0 to 8V signal used for active current sharing.				
Write Protect	For factory use only.				
PS A0	Sets I ² C Address. Low = 0, High = 1 Signal has 4.75kohm pull up resistor to 3V				
SDA	I ² C Data line (3.3V).				
SCL	I ² C Clock line (3.3V).				
Tach_1	Pulses per fan revolution; variable in temperature function.				
Input_OK/H	High signal indicates DC input voltage is within PSU limits. Signal is open drain with an internal 1kohm pull up resistor to 3.3Vdc				
Present/L	100 Ohm resistor internally connected to RTN allowing the PSU to be detected on insertion.				
PS_Kill	Output enable. Pulled low in conjunction with PS_ON being pulled low allows V1 to be activated. Signal has internal 100kohm pull-up resistor to 3V.				
+12V Sense	Connect to positive side of load				
+12V Rtn Sense	Connect to negative side of load				
Alert/L	Low signal indicates PSU fan is running below speed or an overtemperature limit was exceeded. Signal is open drain with a 1kohm pull-up resistor to 3.3V.				
PWROK/H	High signal indicates both outputs are within regulation limits. Signal is open drain with a 1kohm pull-up resistor to 3.3V.				

¹ Refer to product specification for internal pull-up impedances and timing of these signals.

I²C Bus Management Interface

Static	Includes static information such as: part number and revision level, output rating, serial number, date code, and manufacturing location.	
Status (Logic 1 or 0)	DC Input OK. DC Output OK. Overtemperature. Overcurrent. Fan OK. Overvoltage Alert Undervoltage Alert	
Real-Time Monitoring	Output voltage (main output). Output current (main output). Input voltage (VDC). Input current (IDC).	LSB = 20 mV LSB = 200 mA LSB = 30 mV LSB = 15 mA

Safety, Regulatory, and EMC Specifications

Parameter	Conditions/Description	Min.	Nom.	Max.	Units
Agency Approvals	UL 60950-1/CSA 60950-1 (cCSAus), EN 60950-1 (TÜV), CE Mark for LVD (pending).				
Electromagnetic Interference	FCC CFR title 47 Part 15 Sub-Part B, EN 55022/CISPR 22.	Conducted: A Radiated: A			Class
Harmonics	Per IEC 61000-3-2.	N/A			Class
Voltage Fluctuation and Flicker	Per IEC 61000-3-3.	N/A			
ESD Susceptibility	Per EN 61000-4-2	8		.	kV
Radiated Susceptibility	Per EN 61000-4-3	10		.	V/m
EFT/Burst	Per EN 61000-4-4	±1		.	kV
Input Transient Protection	Per EN 61000-4-5	Line-to-Line: 0.5 Line-to-Ground: 0.5		.	kV
RF Conducted Disturbances	Per EN 61000-4-6, Level 2.	10		.	V
Voltage Interruptions	Per EN 61000-4-11, performance criterion B 30%. Per EN 61000-4-11, performance criterion C 60%. Per EN 61000-4-11, performance criterion C 95%.	N/A		.	ms ms Sec
Leakage Current		N/A			mA
Magnetic field	EN61000-4-8	30			A/m

Environmental Specifications

Parameter	Conditions/Description	Min.	Nom.	Max.	Units
Altitude	Operating.			4000	m
Operating Temperature	Internal DC fan for cooling. At 100% load:	0		50	°C
Storage Temperature		-40		70	°C
Temperature Coefficient	0 °C to 45 °C (after 15-minute warm-up).			0.02	%/°C
Relative Humidity	Non-condensing. @ 40 °C	5		93	%RH
Shock	Operating: half-sine, 11 ms, 10 shock per face, 6 faces			7	G
	Non-Operating: half-sine, 11 ms, 10 shock per face, 6 faces			30	G
Vibration	Operating: 3 axis swept sine 5-500 Hz, 1 octave/min, 5 sweep cycles per axis			1	G
	Non-operating: random 10-500 Hz.			3.5	Grms

Reliability

Parameter	Conditions/Description	Min.	Nom.	Max.	Units
MTBF	(Calculated) Bellcore Ground Benign @ 25 °C.	250 000			hrs

LED Indicators

Indicator	LED Color
Power Good	GREEN
DC OK	GREEN
FAIL	AMBER

Mechanical Drawings: (Drawing dimensions are shown in mm)

Weight: 1.37 kg

Overall Dimensions:

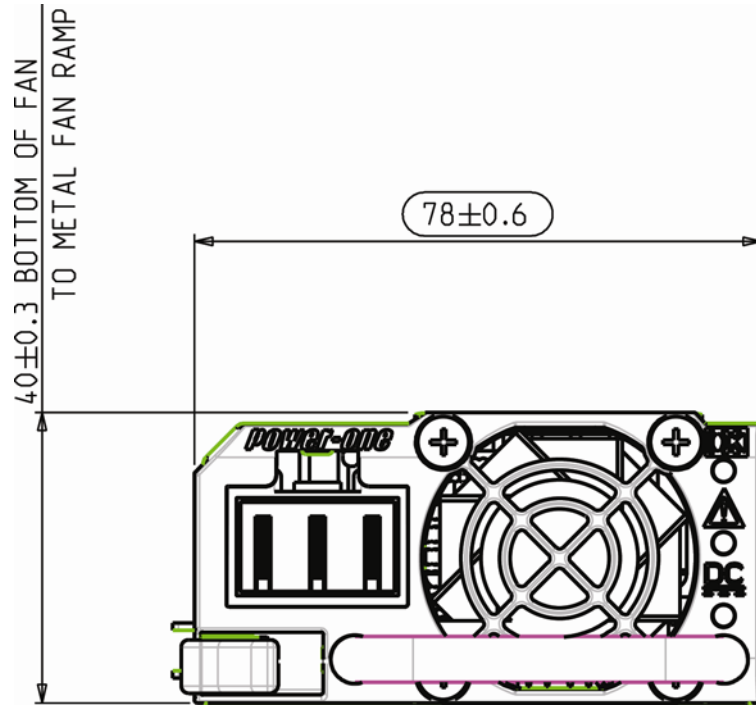

FRONT VIEW

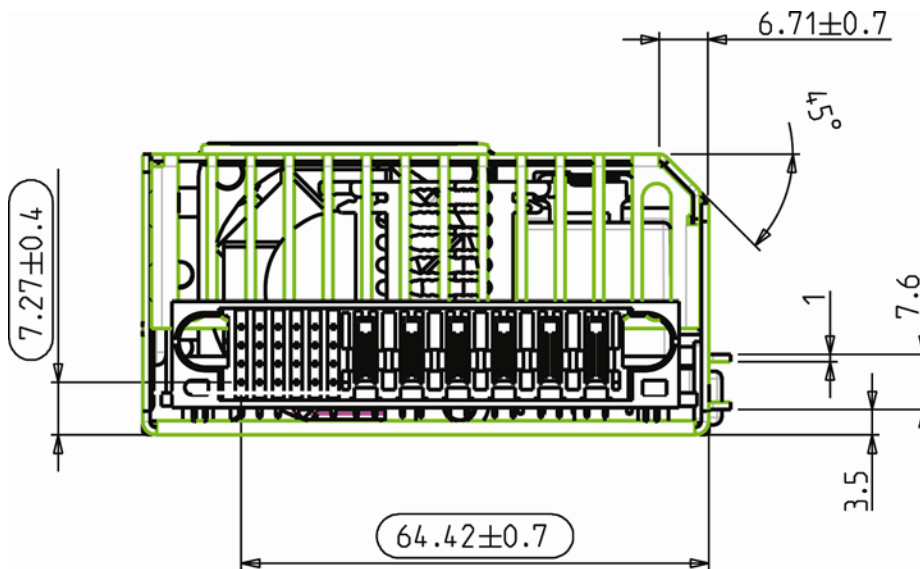

REAR VIEW

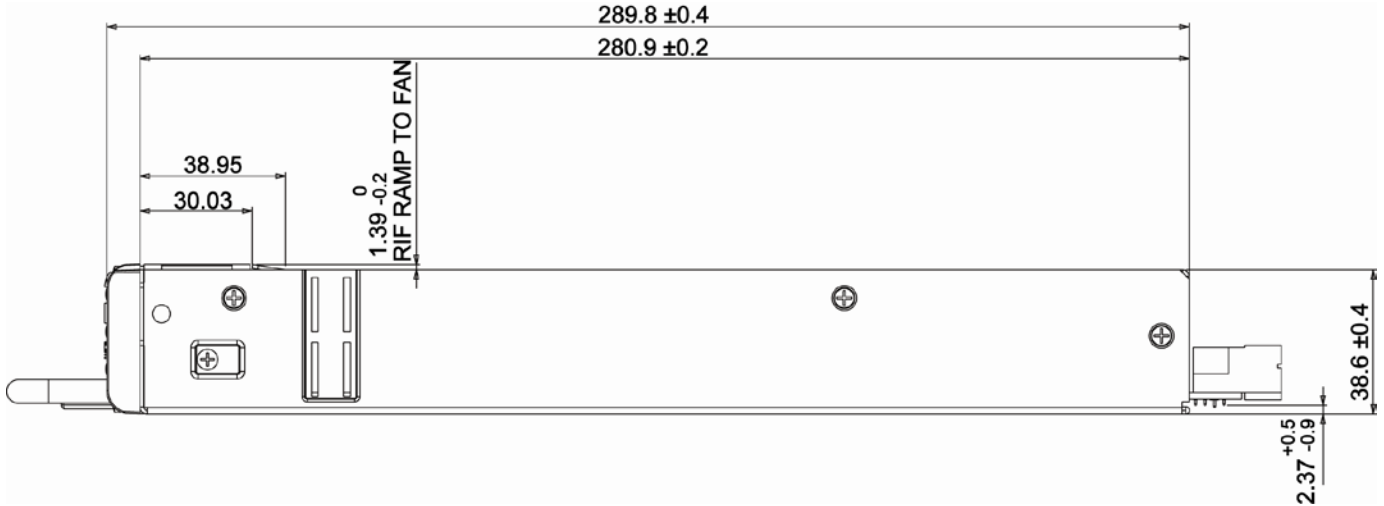

SIDE VIEW

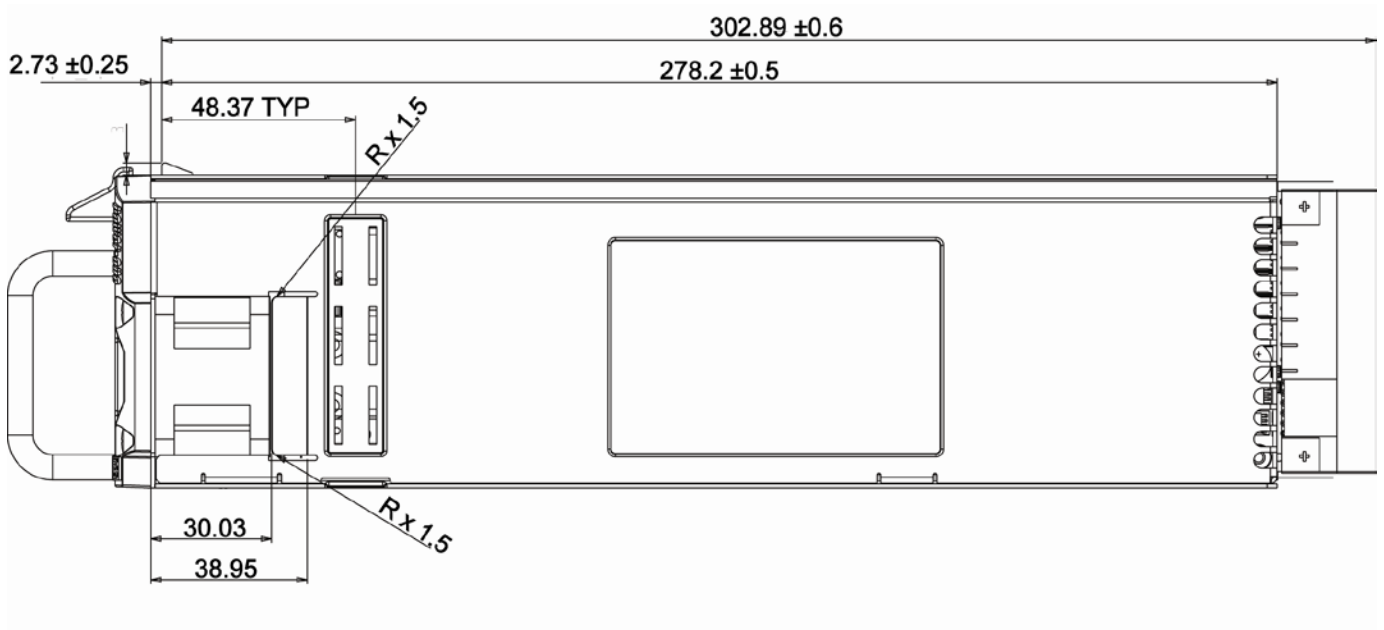

TOP VIEW

Connector Information

Power Supply:
Input – DP5ZJW0300-001

Output - P/N FCI 51721-10002406AA or equivalent

Mating Connections:

Input – DP5TJY0300-001

Output - P/N: FCI 51741-10002406CC

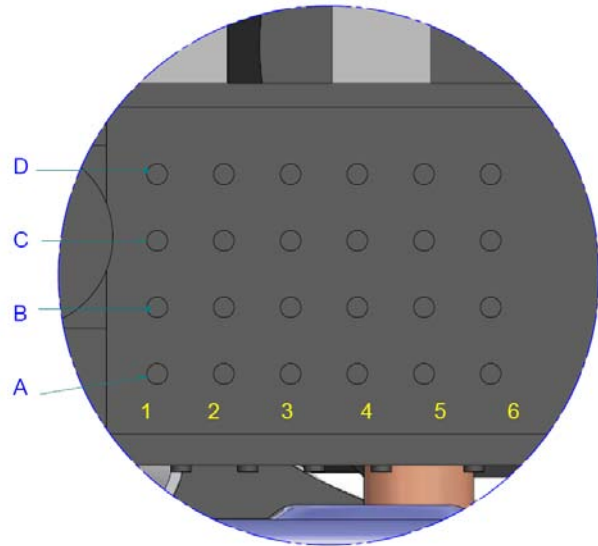
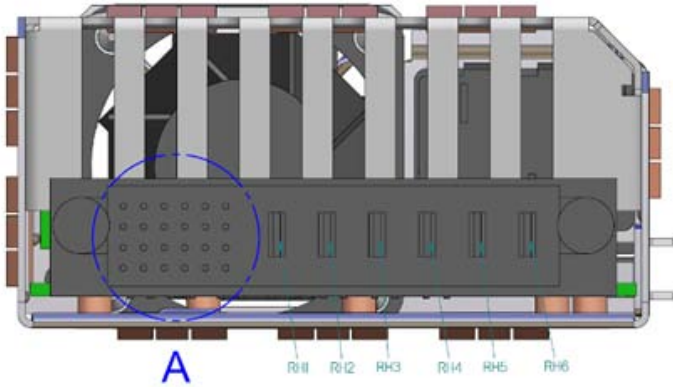

OUTPUT CONNECTOR:

FCI (POWER BLADE)
51721-10002406AC OR EQUIVALENT

WILL MATE WITH SYSTEM BOARD CONNECTOR:

FCI (POWER BLADE) **STRAIGHT IN CONNECTOR**
5174-10002406AA
5174-10002406BA
5174-10002406CB

FCI (POWER BLADE) **RIGHT ANGLE CONNECTOR**
51761-10002406AA
51761-10002406BA
51761-10002406CB

Pin	Signal Name
RH1	+12V Return
RH2	+12V Return
RH3	+12V Return
RH4	+12V
RH5	+12V
RH6	+12V
A1	PS_Kill
A2	+12V I Share
A3	Rtn
A4	Write_Protect
A5	PS_A0
A6	+3.3V SB
B1	Rtn
B2	+12V Rtn_Sense
B3	Rtn
B4	+3.3V SB
B5	SDA
B6	PS_ON/L
C1	Rtn
C2	TACH_1
C3	Rtn
C4	+3.3V SB
C5	SCL
C6	Input_OK/H
D1	Present/L
D2	+12V_Sense
D3	Rtn
D4	+3.3V SB
D5	Alert/L
D6	PWROK/H



NOTES: UNLESS OTHERWISE SPECIFIED

NUCLEAR AND MEDICAL APPLICATIONS - Power-One products are not designed, intended for use in, or authorized for use as critical components in life support systems, equipment used in hazardous environments, or nuclear control systems without the express written consent of the respective divisional president of Power-One, Inc.

TECHNICAL REVISIONS - The appearance of products, including safety agency certifications pictured on labels, may change depending on the date manufactured. Specifications are subject to change without notice.

Looking for pricing, stock, or lifecycle information?

Click below to explore more details on WIN SOURCE:

-  [View SFD1200-12BG on WIN SOURCE](#)
-  [Bel Power Solutions Information](#)

Optimize Your Supply Chain with WIN SOURCE Solutions

-  Global Sourcing Solution
-  Obsolete Management
-  Cost Control Management
-  Shortage Management
-  Alternative Solution
-  Excess Inventory Management