

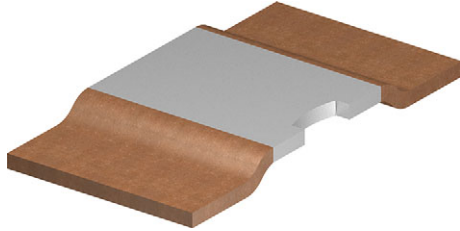

**THE DATASHEET OF
WSLF25123L000FEA**



Power Metal Strip® Resistors, Low Value (Down to 0.0003 Ω), Surface-Mount



LINKS TO ADDITIONAL RESOURCES



FEATURES

- Power Metal Strip® all-welded construction is ideal for all types of current sensing, voltage division, and pulse applications
- Solid metal nickel-chrome, manganese-copper, or manganese-copper-tin alloy resistive element with low TCR (< 20 ppm/°C)
- Proprietary processing technique produces extremely low resistance values, down to 0.0003 Ω
- Sulfur resistance by construction that is unaffected by high sulfur environments
- Very low inductance (< 2 nH)
- Low thermal EMF (< 3 μV/°C)
- AEC-Q200 qualified ⁽¹⁾
- Material categorization: for definitions of compliance please see www.vishay.com/doc?99912

 AUTOMOTIVE
GRADE

RoHS
COMPLIANT

 HALOGEN
FREE
GREEN
(5-2008)

Note

- ⁽¹⁾ Flame retardance test may not be applicable to some resistor technologies

STANDARD ELECTRICAL SPECIFICATIONS							
GLOBAL MODEL	SIZE	POWER RATING $P_{70^{\circ}\text{C}}$ W ⁽¹⁾	POWER RATING $P_{100^{\circ}\text{C}}$ W ⁽²⁾	TOLERANCE %	RESISTANCE VALUE RANGE Ω	RESISTANCE VALUES CURRENTLY AVAILABLE ⁽³⁾ Ω	WEIGHT (typical) g/1000 pieces
WSLF2512	2512	10.0	9.0	1.0, 5.0	0.3m to 0.5m	0.3m, 0.5m	258
	2512	6.0	4.0	1.0, 5.0	1m to 2m	1m, 1.3m, 1.5m, 2m	212
	2512	4.0	3.0	1.0, 5.0	3m	3m	267
	2512	3.0	3.0	1.0, 5.0	4m	4m	267

Notes

- Qualified to AEC-Q200 rev. D
 - Part marking: no part marking on these parts
- ⁽¹⁾ See Fig. 1 - Ambient Temperature Derating
⁽²⁾ See Fig. 2 - Terminal Temperature Derating
⁽³⁾ Other values may be available, contact factory

GLOBAL PART NUMBER INFORMATION																	
Global Part Numbering: WSLF25121L000FEA (WSLF2512, 0.001 Ω, ± 1 %) (visit www.vishay.net Vishay Dale parts numbering manual for all options)																	
W	S	L	F	2	5	1	2	1	L	0	0	0	F	E	A		
GLOBAL MODEL (8 digits) WSLF2512				RESISTANCE VALUE (5 digits) L = mΩ L5000 = 0.0005 Ω 1L000 = 0.0010 Ω			TOLERANCE CODE (1 digit) F = ± 1.0 % J = ± 5.0 %		PACKAGING CODE ⁽¹⁾ (2 digits) EA = lead (Pb)-free, tape / reel				SPECIAL ⁽²⁾ (2 digits) Reserved for future specials				

Notes

- ⁽¹⁾ Packaging code: EB (lead (Pb)-free) are non-standard packaging codes designating 1000 piece reels. These non-standard packaging codes are identical to our standard EA (lead (Pb)-free), except that they have a package quantity of 1000 pieces
- ⁽²⁾ Follow link for customization capabilities: www.vishay.com/doc?48163

TECHNICAL SPECIFICATIONS		
PARAMETER	UNIT	WSLF RESISTOR CHARACTERISTICS
Component temperature coefficient (including terminal) ⁽¹⁾ TCR measured from -55 °C to 150 °C	ppm/°C	± 200 for 0.3 mΩ and 0.5 mΩ
		± 170 for 1.0 mΩ, 1.3 mΩ, and 1.5 mΩ
		± 70 for 2 mΩ, 3 mΩ, and 4 mΩ
Element TCR ⁽²⁾	ppm/°C	< 20
Operating temperature range	°C	-65 to +170
Maximum working voltage ⁽³⁾	V	$(P \times R)^{1/2}$

Notes

- Consult factory for detailed TCR performance across full temperature range as performance is resistance value specific
- (1) Component TCR - total TCR that includes the TCR effects of the resistor element and the copper terminal
- (2) Element TCR - only applies to the alloy used for the resistor element
- (3) Maximum working voltage - the WSL is not voltage sensitive, but is limited by power / energy dissipation and is also not ESD sensitive

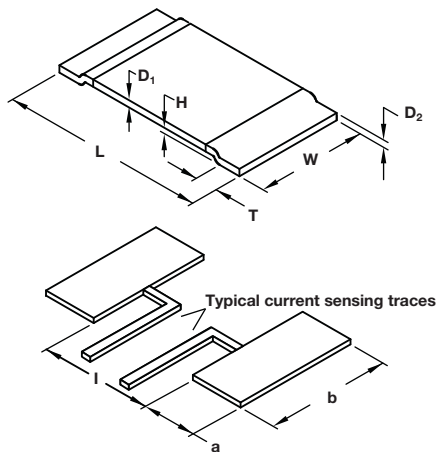
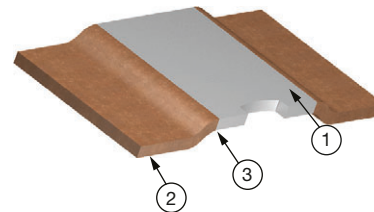
DIMENSIONS in inches (millimeters)

CONSTRUCTION OUTLINE

- ① Resistive element: element material used is dependent on resistance value. Refer to Element Material in table)
- ② Terminal: solid copper
- ③ Terminal / element weld

Notes

- 3D models available: www.vishay.com/doc?30335
- Surface mount solder profile recommendations: www.vishay.com/doc?31052

MODEL	DIMENSIONS				SOLDER PAD DIMENSIONS		
	L	W	H	T	a	b	l
WSLF2512	0.250 ± 0.006 (6.35 ± 0.15)	0.120 ± 0.008 (3.02 ± 0.2)	0.0138 ± 0.0012 (0.35 ± 0.03)	0.045 - 0.016 (1.14 - 0.4)	0.071 (1.80)	0.13 (3.40)	0.13 (3.40)

GLOBAL MODEL	RESISTANCE VALUE (mΩ)	THERMAL RESISTANCE (°C/W)	THICKNESS in inches (millimeters)		ELEMENT MATERIAL
			D ₁	D ₂	
WSLF2512	0.3	3.8	0.040 (1.02)	0.040 (1.02)	Mn-Cu-Sn
	0.5	6.7	0.033 (0.84)	0.033 (0.84)	Mn-Cu
	1.0	12.1	0.017 (0.43)	0.017 (0.43)	Mn-Cu
	1.3	14.6	0.013 (0.33)	0.013 (0.33)	Mn-Cu
	1.5	14.5	0.011 (0.28)	0.011 (0.28)	Mn-Cu
	2.0	17.1	0.028 (0.71)	0.028 (0.71)	Ni-Cr
	3.0	18.2	0.019 (0.48)	0.019 (0.48)	Ni-Cr
	4.0	18.5	0.014 (0.36)	0.014 (0.36)	Ni-Cr

Note

- (1) The full power rating of Power Metal Strip resistors are dependent upon the ability of the circuit board to dissipate the heat energy created in the resistance element. It is recommended to follow common design practices for power semiconductors that ensure the junction temperature is maintained within thermal limits by using large pad surfaces, thermal vias, heavier copper weights, internal layers as well as other thermal spreading features. The thermal resistance values provided function in the same manner as junction to terminal temperature

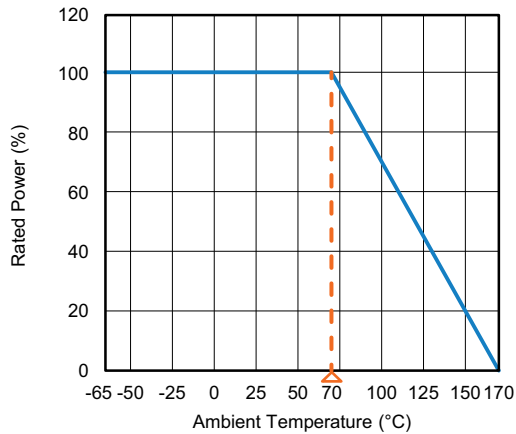
DERATING- AMBIENT TEMPERATURE

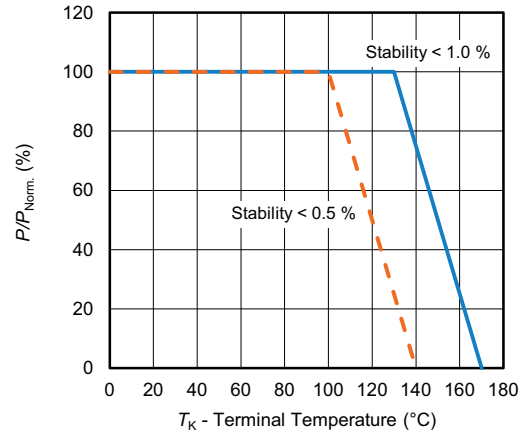
 Fig. 1 - $P_{70\text{ }^\circ\text{C}}$ of Standard Electrical Specification Table

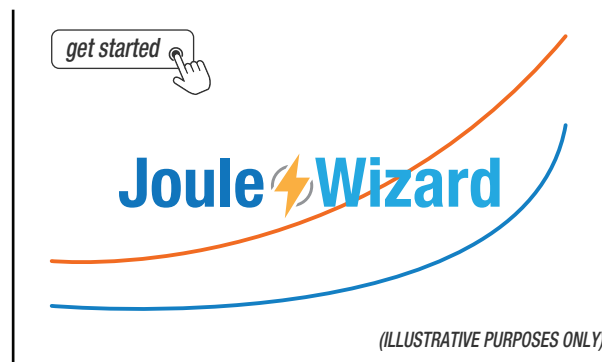
DERATING - TERMINAL TEMPERATURE

 Fig. 2 - $P_{100\text{ }^\circ\text{C}}$ Rated Power of Standard Electrical Specification Table (Example L5000)

PULSE CAPABILITY

www.vishay.com/en/resistors/joulewizard/

PERFORMANCE		
TEST	CONDITIONS OF TEST	TEST LIMITS
Thermal shock	-55 °C to +150 °C, 2000 cycles, 15 min at each extreme	± 0.5 %
Short time overload	Refer to link for short time overload performance and pulse capability; www.vishay.com/en/resistors/power-metal-strip-calculator/	± 0.5 %
Low temperature storage	-65 °C for 24 h	± 0.1 %
High temperature exposure	2000 h at +170 °C	± 1.0 %
Bias humidity	+85 °C, 85 % RH, 10 % bias, 1000 h	± 0.5 %
Mechanical shock	100 g's for 6 ms, 5 pulses	± 0.2 %
Vibration	Frequency varied 10 Hz to 2000 Hz in 1 min, 3 directions, 12 h	± 0.2 %
Load life	2000 h at +70 °C, 1.5 h "ON", 0.5 h "OFF"	± 1.0 %
Resistance to solder heat	+260 °C solder, 10 s to 12 s dwell, 25 mm/s emergence	± 0.5 %
Moisture resistance	MIL-STD-202, method 106, 0 % power, 7a and 7b not required	± 0.1 %

Note

- Contact ww2bresistors@vishay.com for application specific performance requirements. Typical performance is better than stated test limits



PACKAGING (1)				
MODEL	REEL			
	TAPE WIDTH	DIAMETER	PIECES/REEL	CODE
WSLF2512	12 mm / embossed plastic	330 mm / 13"	4000	EA

Notes

- Embossed carrier tape per EIA-481
- (1) Additional packaging details at www.vishay.com/doc?20051

LINKS TO RELATED DOCUMENTS	
SELECTOR GUIDE	
Overview of Automotive Grade Products	www.vishay.com/doc?49924
TECHNICAL NOTES	
SMD Current Sense: AEC-Q200 vs. Vishay Qualification	www.vishay.com/doc?30416
MIL-PRF vs. AEC-Q200: Do You Know What You Are Getting?	www.vishay.com/doc?11000
WHITE PAPER	
Thermal Management for Surface-Mount Devices	www.vishay.com/doc?30380
Temperature Coefficient of Resistance for Current Sensing	www.vishay.com/doc?30405
OTHER	
WSLF Product Design Tools	www.vishay.com/en/product/30193/tab/designtools-ppg/



Disclaimer

ALL PRODUCT, PRODUCT SPECIFICATIONS AND DATA ARE SUBJECT TO CHANGE WITHOUT NOTICE TO IMPROVE RELIABILITY, FUNCTION OR DESIGN OR OTHERWISE.

Vishay Intertechnology, Inc., its affiliates, agents, and employees, and all persons acting on its or their behalf (collectively, "Vishay"), disclaim any and all liability for any errors, inaccuracies or incompleteness contained in any datasheet or in any other disclosure relating to any product.

Vishay makes no warranty, representation or guarantee regarding the suitability of the products for any particular purpose or the continuing production of any product. To the maximum extent permitted by applicable law, Vishay disclaims (i) any and all liability arising out of the application or use of any product, (ii) any and all liability, including without limitation special, consequential or incidental damages, and (iii) any and all implied warranties, including warranties of fitness for particular purpose, non-infringement and merchantability.

Statements regarding the suitability of products for certain types of applications are based on Vishay's knowledge of typical requirements that are often placed on Vishay products in generic applications. Such statements are not binding statements about the suitability of products for a particular application. It is the customer's responsibility to validate that a particular product with the properties described in the product specification is suitable for use in a particular application. Parameters provided in datasheets and / or specifications may vary in different applications and performance may vary over time. All operating parameters, including typical parameters, must be validated for each customer application by the customer's technical experts. Product specifications do not expand or otherwise modify Vishay's terms and conditions of purchase, including but not limited to the warranty expressed therein.

Hyperlinks included in this datasheet may direct users to third-party websites. These links are provided as a convenience and for informational purposes only. Inclusion of these hyperlinks does not constitute an endorsement or an approval by Vishay of any of the products, services or opinions of the corporation, organization or individual associated with the third-party website. Vishay disclaims any and all liability and bears no responsibility for the accuracy, legality or content of the third-party website or for that of subsequent links.

Except as expressly indicated in writing, Vishay products are not designed for use in medical, life-saving, or life-sustaining applications or for any other application in which the failure of the Vishay product could result in personal injury or death. Customers using or selling Vishay products not expressly indicated for use in such applications do so at their own risk. Please contact authorized Vishay personnel to obtain written terms and conditions regarding products designed for such applications.

No license, express or implied, by estoppel or otherwise, to any intellectual property rights is granted by this document or by any conduct of Vishay. Product names and markings noted herein may be trademarks of their respective owners.

Looking for pricing, stock, or lifecycle information?

Click below to explore more details on WIN SOURCE:

 [View WSLF25123L000FEA on WIN SOURCE](#)

 [Vishay Information](#)

Optimize Your Supply Chain with WIN SOURCE Solutions

-  Global Sourcing Solution
-  Obsolete Management
-  Cost Control Management
-  Shortage Management
-  Alternative Solution
-  Excess Inventory Management